



Way of Life!

Genuine Marine Accessories



Table of Contents

Dear Customer,

Quality. Dependability. Innovation. Everything you expect from your outboard motor is delivered with style by Suzuki. Demand no less from the products you choose to enhance your total boating pleasure. Demand Suzuki Genuine Accessories. This Suzuki Genuine Accessories Catalog represents our commitment to provide you with the finest products available. From our classic line of matching instruments and gauges to our custom-engineered propellers and rigging items, you can depend on Suzuki Genuine Accessories for optimum performance. Take a few minutes to browse through this catalog then be sure to visit your Authorized Suzuki Dealer for complete ordering information.

For the Suzuki Marine Dealer nearest you, visit us on the web at www.suzuki.com or www.suzukimarine.com.

Thank you.

Suzuki Genuine Accessories

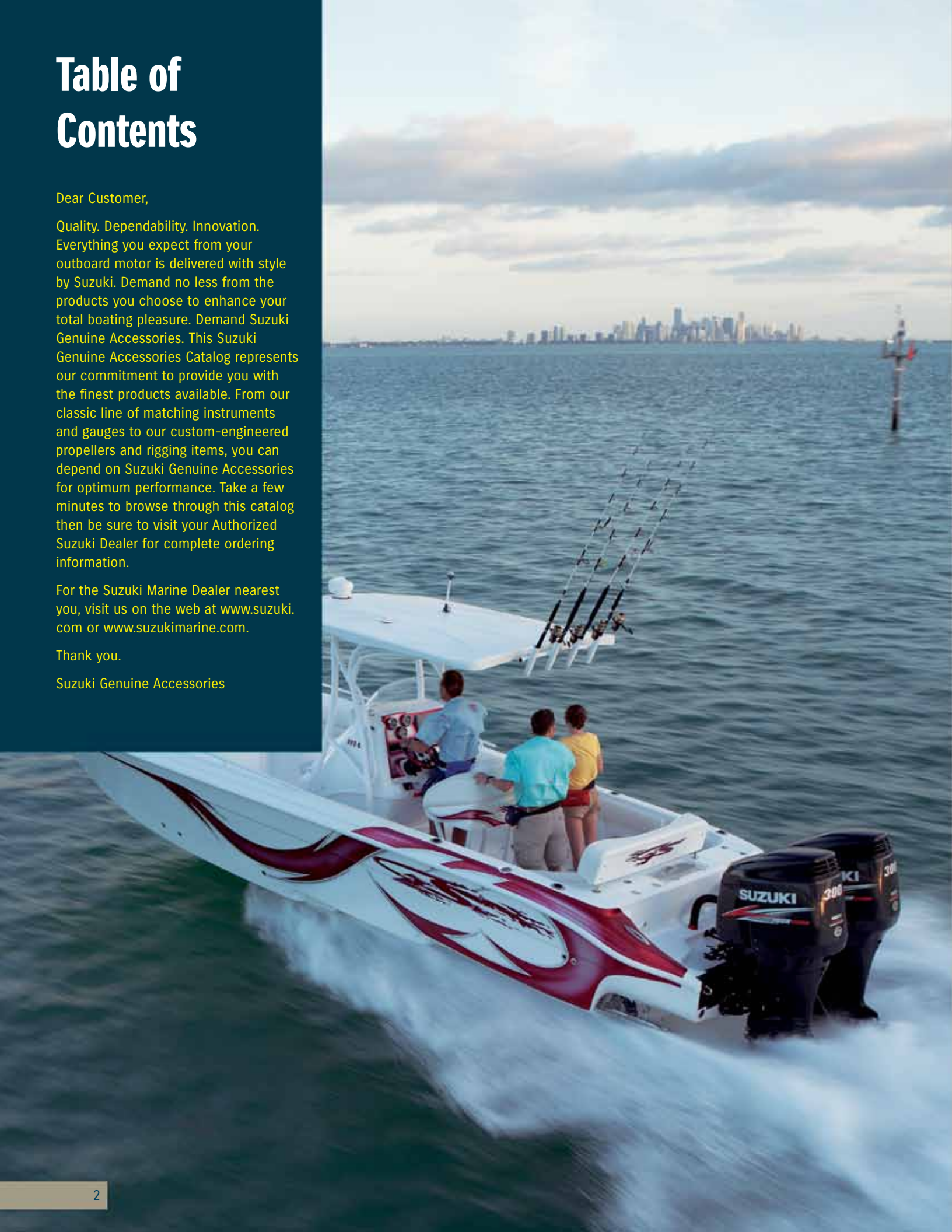

Suzuki Modular Instrument Systems

SMIS Multi-Function Gauges	
4" Gauge	4 - 5
2" Gauge.	4 - 5
Engine Interface and Power Cables	
Connection Cables	5
SMIS Engine Interface	5
SMIS Adapter Cables.	5
SMIS Power Cable.	5
Connection Hardware	
K8 Adapter	5
NMEA Adaptor Harness	5
Power Node	5
T-Connector	5
Terminating Resistors.	5
Sensors	
Fluid Level Sensor.	5
GPS Receiver Module	5
Speed Sensor	5
Temperature Sensor	5
Optional Instrument Trims	4 - 5

Suzuki Instruments

4" Tachometer with Monitor Gauge	6 & 8
4" Tachometer	6 & 8
4" Speedometer	6 & 8
2" Fuel Gauge.	7 & 9
2" Hour Meter	7 & 9
2" Monitor Gauge	7 & 9
2" Trim Gauge.	7 & 9
2" Voltmeter	7 & 9
2" Water Pressure Gauge 30psi	7 & 9
Water Pressure Gauge Installation Kits.	7 & 9
4" Tachometer with Monitor Gauge	10 & 12
4" Tachometer	10 & 12
4" Trolling Tachometer	10 & 12
Trolling Switch.	10 & 12
4" Speedometer 80mph	11 & 13
4" Speedometer 50mph	11 & 13
2" Fuel Gauge	11 & 13
2" Hour meter.	11 & 13
2" Trim Meter	11 & 13
2" Voltmeter	11 & 13
2" Water Pressure Gauge 15psi	11 & 13
Water Pressure Gauge Installation Kits.	11 & 13

Suzuki Precision Control

Electronic Throttle and Shift Systems	
SPC Box Only	14 - 15
Flush Mount SPC Kit	14 - 15
Single Station SPC Kit, Single Engine.	14 - 15
Dual Station SPC Kit, Single Engine	14 - 15
Single Station SPC Kit, Dual Engines	14 - 15
Dual Station SPC Kit, Dual Engines.	14 - 15
Single Station SPC Kit, Triple Engines	14 - 15
Dual Station SPC Kit, Triple Engines.	14 - 15
Single Station SPC Kit, Quad Engines	14 - 15
Dual Station SPC Kit, Quad Engines.	14 - 15
Control Panel Assemblies.	16 - 17
Engine Control Panel Assemblies.	16 - 17
Battery Isolator Lead.	17
Emergency Stop Switch Panel Assembly	17
Main Power Key Switch Assembly	17
Replacement Wiring Harnesses	17
Wiring Harnesses.	17

Control Boxes/Cables & Riggings

Deluxe Single Binnacle Control Box Kit	18 - 19
Deluxe Dual Binnacle Control Box Kit	18 - 19
Deluxe Flush Mount Control Box Kit.	19
Side Mount Control Box Kits.	18 - 19
Replacement Control Boxes.	18 - 19
Miscellaneous Components	19
Switch Panels Assemblies	20 - 21
Replacement Land Yard	20 - 21
Battery Isolator Lead.	21
Suzuki Performance Remote Control Cables.	21
Thru-Hull Fitting and Hose Kit	21
Wiring Harnesses.	21

Steering

New Tiller Handle Kits.	22 - 23
Drag Link Kits	23
Dual Engine Tie Bar.	23
Dual Cable Steering Kit.	23
Tiller Handle Kits.	23
Twin Engine Adapter Plate Set	23

Fuel Systems

Compact Water Separator / Fuel Filter	24 - 25
Water Separator / Fuel Filter.	24 - 25
Plastic Fuel Tanks	24 - 25
Fuel Connectors (Motor Side)	25
Fuel Hose	24
Fuel Hose Connectors	25
Fuel Tank Connectors.	25

Suzuki Propellers

Information Page	26 - 27
Propeller Hardware Kit	27
Propeller Lock.	27
Bushing Application	28
Propellers	28 - 29

Repair Kits / Zinc Anodes

Gear Case Seal Kit.	30 - 31
Water Pump Repair Kit	30 - 31
Carburetor Repair Kit	31
Aluminum Anodes for Brackish/Saltwater	31
Magnesium Anodes for Freshwater Use.	31
Zinc Anodes for Saltwater Use.	31

Application Chart

Accessories Applications	32 - 35
------------------------------------	---------

Care & Maintenance

Fuel Injector Cleaner	38 - 39
Fuel Conditioner & Water Remover	38 - 39
Marine 4-Cycle Engine Oil	38 - 39
Hypoid Gear Oil.	39
Gear Oil Capacities	39
Oil Drain Plug & Gasket.	39
Oil Change Periods / Filters / Capacities	39
Spark Plugs.	39
Brake & Contact Cleaner	40 - 41
Engine Covers.	40 - 41
Spray Carburetor & Choke Cleaner	40 - 41
Spray Cleaner & Polish	40 - 41
Wheel Cleaner.	40 - 41
Flush Hose Attachment	41
Flush Kit	41
Silicone Seal	41
Suzuki Bond 1207B.	41
Thread Locks.	41
Water Resistant Grease.	41

Suzuki Marine Style

.	42 - 43
-----------	---------

Custom Imprint Program

.	44 - 45
-----------	---------

Suzuki Promotional Items

.	46 - 47
-----------	---------

Modular Instrument System

Suzuki Modular Instrument System (SMIS) uses an easy to connect and expandable cable system to transmit graphic and numerical data to Multi-Function gauges. This easy to set up and install system can be used with nearly any boat and DF15A thru DF300 Suzuki Outboard. Connected to the NMEA 2000® compatible system, the gauges can display real-time readings from compatible electronic probes and the exclusive SMIS engine interface to monitor all engine functions. (Engine Monitor with 4" gauge only). SMIS Multi-Function Gauges.



990C0-88161
4" Multi-Function Gauge



990C0-88150
2" Multi-Function Gauge



Fuel Gauge Display



Trim Gauge Display



Dual Engine Tachometer Display



990C0-88025-6PK
2" Optional Trim - Chrome



990C0-88027-6PK
2" Optional Trim - White



990C0-88028-6PK
2" Optional Trim - Grey

SMIS Multi-Function Gauges

4" Multi-Function Gauge

The 4" Multi-Function Gauge uses a state-of-the-art high-contrast, dot matrix display to monitor real-time graphic and numerical digital data. When connected into the SMIS system, it can monitor all engine functions, Speedometer, Tachometer, GPS* and many others.

990C0-88162-KIT 4" multi-function gauge kit includes:

990C0-88161	4" Multi-Function Gauge	1
990C0-88113	Female Terminator	1
990C0-88114	Male Terminator	1
990C0-88110	NMEA "T"	3
990C0-88112	Power Cable	1
990C0-88147	Interface Cable	1

990C0-88161 4" Multi-Function Gauge (Gauge Only)

*GPS requires additional hardware.

2" Multi-Function Gauge

The 2" Multi-Function Gauge is capable of all functions of the 4" gauge except Engine Monitoring Functions. When connected to the SMIS system, it can be programmed to monitor all other functions.

990C0-88152-KIT 2" multi-function gauge kit includes:

990C0-88150	2" Multi-Function Gauge	1
990C0-88113	Female Terminator	1
990C0-88114	Male Terminator	1
990C0-88110	NMEA "T"	3
990C0-88112	Power Cable	1
990C0-88147	Interface Cable	1
990C0-88108	25' Backbone Cable	1
990C0-88136	SMIS Adaptor	1

990C0-88150 2" Multi-Function Gauge (Gauge Only)

GPS Receiver Module

GPS receiver module interface for display of accurate location and speed on Multi-Function Gauges.

990C0-88120 GPS Module



990C0-88120
GPS Receiver Module

Optional Instrument Trims

Change the standard black bezel to suit your application. 4 different bezel finishes to choose from for 2" or 4" Multi-Function gauges.

990C0-88021-6PK	Chrome Bezel 4" (not shown)
990C0-88023-6PK	White Bezel 4" (not shown)
990C0-88024-6PK	Grey Bezel 4" (not shown)
990C0-88025-6PK	Chrome Bezel 2"
990C0-88027-6PK	White Bezel 2"
990C0-88028-6PK	Grey Bezel 2"

Engine Interface Cable and Power Cables

Suzuki Modular Instrument System Engine Interface Cable (not shown)

The most important part of the SMIS data system. DF9.9B thru DF250 Suzuki Outboards can connect to the system using the exclusive SMIS Engine Interface. (Adaptor Cable also needed for DF150G/175G/250AP/300AP applications.)

990C0-88147 Engine Interface Cable

SMIS Adapters (not shown)

Special Adaptor must be used with SMIS Engine Interface to connect the DF150G/175G/250AP/300AP Outboard to the system.

990C0-88131 Single Engine Adapter

990C0-88132 Dual Engine Adapter

990C0-88133 Triple Engine Adapter

990C0-88132 x2 Quad Engine Adapter

990C0-88136 SMIS Adaptor
- to connect at engine SDS connector

990C0-88035 Adapter for 2008 DF40 - 250
- old style 8 pin connector

Connection Cable (not shown)

The Extension Cable is the mainline of the Suzuki Modular Instrument System. Data communication runs the length of the boat, capped at each end with a 120 ohm Terminating Resistor. NMEA 2000 compatible sensors or other devices can be added by the use of T-Connectors throughout the system.

990C0-88104 2' Connection cable

990C0-88105 6' Connection cable

990C0-88107 15' Connection cable

990C0-88108 25' Connection cable

SMIS Power Cable (not shown)

Fused(3A) lead connects extension cable to the power source.

990C0-88112 Single Power Cable

Power Node (not shown)

Allows network to be powered from multiple power sources (key switch, accessory switch, etc...).

990C0-88130 Quad Power Node



990C0-88136
Adapter Interface to SDS Port on Engine

K8 Adapter (not shown)

Required in order to put new style 990C0-88147 Interface cable on older system with blue connector.

990C0-88141

NMEA Adaptor Harness (not shown)

Allows connection to other NMEA devices (Device NET).

990C0-88137 NMEA Device to Blue "T"

990C0-88029 Blue Device to NMEA "T"

Connection Hardware

T-Connector

T-Connectors link all compatible cable, data and sensor devices and can be easily secured.

990C0-88110 T-Connector

Terminating Resistors

120 ohm Terminating Resistors are required for any open cable ends in the system.

990C0-88113 Terminator - Female

990C0-88114 Terminator - Male

Sensors

Fluid Level Sensor (not shown)

Monitors fluid levels such as fuel, live well water level, etc. 10ft cable.

990C0-88116 Fluid Level Sensor

Speed Sensor (not shown)

Paddle wheel-type speed sensor. 10ft cable.

990C0-88117 Speed Wheel

Temperature Sensor (not shown)

Surface Water Temperature sensor. 10ft cable.

990C0-88118 Temperature Sensor

990C0-88119 Temperature Sensor - Thru Hull

Pressure Sensor (not shown)

990C0-88139 Pressure Sensor

34970-98J01 Water Pressure Kit DF70A/90A/300



990C0-88110
T-Connector



990C0-88113
Terminating Register - Female



990C0-88114
Terminating Register - Male

Suzuki Instruments

Economically priced, high quality instruments feature easy plug-in wiring connections, perimeter-lighted dial, black bezels, contoured pointers and fog resistant glass lenses. All use standard 2" or 4" diameters for easy dash installation.



99105-80001
4" Tachometer / Monitor



99105-80000
4" Tachometer



99105-80008
2" Engine Monitor Gauge



99105-80002
4" Speedometer



99105-80005
2" Trim Gauge



99105-80007
2" Hour Meter



99105-80003
2" Fuel Gauge



99105-80006
2" Voltmeter



99105-80004
2" Water Pressure Gauge

4" Tachometer

7,000 max R.P.M. Tachs are available with or without 4-Stroke monitor functions. Monitor functions include: Low Oil Pressure Warning, Engine Temperature Warning, Check Engine Warning and Over-Rev Limit Warning.

99105-80001	Black - With monitor functions
99105-80000	Black - Without monitor functions

2" Engine Monitor Gauge

Engine Monitor Gauge for 4-stroke engines helps alert you to low oil pressure, high engine temperature and engine over-rev.

99105-80008	Black
-------------	-------

4" Speedometer

Easy to read 4" Speedometer features include lighted dial, contoured pointer and fog resistant glass lens. *Requires Tubing 99105-80009.

99105-80002	Black 60 mph
99105-80009*	Speedometer Tubing (not shown)

2" Trim Gauge

To help maintain steering stability and good performance, proper trim angle is essential. The Trim Gauge helps you monitor the trim angle. For use with 2-wire senders.

99105-80005	Black
-------------	-------

2" Hour Meter

Handy Hour Meter helps you keep track of the time between services and total running time.

99105-80007	Black
-------------	-------

2" Fuel Gauge

Adding a Fuel Gauge can help you monitor fuel level. Connects easily using your boat's fuel sending unit harness.

99105-80003	Black
-------------	-------

2" Voltmeter

A well charged battery is essential for quick and easy starts. Monitor the charging system using a Voltmeter.

99105-80006	Black
-------------	-------

2" Water Pressure Gauge 30 psi

Bourdon-tube type gauge measures cooling water pressure. Instructions and dash installation hardware included. Order Installation kit for appropriate model.

99105-80004	Black
-------------	-------

Water Pressure Gauge Installation Kits

Kit includes fittings and hoses needed for motor to gauge connection.

34660-93J00	DF200/225/250
34660-96J00	DF150/175
34660-90J02	DF90/115/115A/140/140A
34660-90J02	DF60A/70A/80A/90A
34660-99E00	DF60/70
34660-90J02	DF40A/50A/50AV/60A/60AV
34660-87J00	DF40/50

Suzuki Instruments

Economically priced, high quality instruments feature easy plug-in wiring connections, perimeter-lighted dial, polished stainless steel bezels, contoured pointers and fog resistant glass lenses. All use standard 2" or 4" diameters for easy dash installation.



99105-80101
4" Tachometer / Monitor



99105-80100
4" Tachometer



99105-80108
2" Engine Monitor Gauge



99105-80102
4" Speedometer



99105-80105
2" Trim Gauge



99105-80107
2" Hour Meter



99105-80103
2" Fuel Gauge



99105-80106
2" Voltmeter



99105-80104
2" Water Pressure Gauge

4" Tachometer

7,000 max R.P.M. Tachs are available with or without 4-Stroke monitor functions. Monitor functions include: Low Oil Pressure Warning, Engine Temperature Warning, Check Engine Warning and Over-Rev Limit Warning.

99105-80101	White - With monitor functions
99105-80100	White - Without monitor functions

2" Engine Monitor Gauge

Engine Monitor Gauge for 4-stroke engines helps alert you to low oil pressure, high engine temperature and engine over-rev.

99105-80108	White
-------------	-------

4" Speedometer

Easy to read 4" Speedometer features include lighted dial, contoured pointer and fog resistant glass lens. *Requires Tubing 99105-80009.

99105-80102	White 60 mph
99105-80009*	Speedometer Tubing (not shown)

2" Trim Gauge

To help maintain steering stability and good performance, proper trim angle is essential. The Trim Gauge helps you monitor the trim angle. For use with 2-wire senders.

99105-80105	White
-------------	-------

2" Hour Meter

Handy Hour Meter helps you keep track of the time between services and total running time.

99105-80107	White
-------------	-------

2" Fuel Gauge

Adding a Fuel Gauge can help you monitor fuel level. Connects easily using your boat's fuel sending unit harness.

99105-80103	White
-------------	-------

2" Voltmeter

A well charged battery is essential for quick and easy starts. Monitor the charging system using a Voltmeter.

99105-80106	White 2" water pressure gauge 30psi
-------------	-------------------------------------

2" Water Pressure Gauge 30 psi

Bourdon-tube type gauge measures cooling water pressure. Instructions and dash installation hardware included. Order Installation kit for appropriate model.

99105-80104	White
-------------	-------

Water Pressure Gauge Installation Kits

Kit includes fittings and hoses needed for motor to gauge connection.

34660-93J00	DF200/225/250
34660-96J00	DF150/175
34660-90J02	DF90/115/115A/140/140A
34660-90J02	DF60A/70A/80A/90A
34660-99E00	DF60/70
34660-90J02	DF40A/50A/50AV/60A/60AV
34660-87J00	DF40/50

Suzuki Instruments

Suzuki Genuine Instruments are custom-designed to provide the quality, reliability and value you expect from Suzuki Products. The wide selection allows you to accurately monitor a variety of essential functions. All instruments are lighted for night time boating and feature standard 2" and 4" diameters for easy installation.



34200-93J40
4" Tachometer / Troll Mode



37860-87L00
Trolling Switch



34200-93J00
4" Tachometer / Monitor Gauge



34200-93J20
4" Tachometer



34100-93J00
4" Speedometer



34800-93J00
2" Trim Gauge



34500-93J00
2" Hour Meter



34300-93J00
2" Fuel Gauge



34600-93J00
2" Voltmeter



34650-93J20
2" Water Pressure Gauge

4" Tachometer With Suzuki Troll Mode Scale

Easy to read 4" Tachometer has a scale from 0-7,000 RPMs for standard use, and a secondary scale from 0-3,000 RPMs with markers at 50 RPM intervals for use with the Suzuki Troll Mode System*. Gauge also includes warning lamps for Engine Temperature, Low Oil, Check Engine and Over-Rev. When in troll mode, Over-Rev lamp stays on to indicate that Troll mode has been engaged. The secondary RPM scale is designed to make setting and maintaining a lower troll speed simple. Fits DF40A/50A/50AV/60A/60AV/70A/90A/115A/140A/150G/175G/250AP/300AP (DF300 requires SMIS gauges).

*See engine owner's manual for information about Suzuki Troll Mode system. Not all models come equipped with trolling mode system. Accessory Troll Mode Switch required for Suzuki Troll Mode System use. Suzuki recommends the use of this gauge for trolling use.

34200-93J50 DF40A/50A/50AV/60A/60AV/70A/90A/115A/140A/150G/175G/250AP/300AP (DF300 with SMIS gauges)

Trolling Mode Control Switch

Allows the use of the Suzuki Troll Mode on equipped engines. When Troll mode is engaged, this switch allows for adjustments of engine RPM in 50 RPM increments, from idle to 1200 RPM to make setting and maintaining a trolling speed easy. Consult owner's manual or Suzuki Outboard Dealer for additional details on Suzuki Troll System operation.

37860-87L00 trolling switch

4" Tachometers

7,000 max R.P.M. Tachs are available with or without 4-Stroke monitor functions. Monitor functions include: Low Oil Pressure Warning, Engine Temperature Warning, Check Engine Warning and Over-Rev Limit Warning.

34200-93J00 with monitor functions 34200-93J20 without monitor

4" Speedometers

Bourdon-tube type speedometer with readings in M.P.H. and Km/h. Includes vinyl tube, plus all installation instructions and hardware.

*Pitot tube 34190-87D00 must be ordered separately for DF50 and under models.

34100-93J00 80 mph 34100-93J20 50 mph (not shown)
34190-87D00* Pitot Tube (not shown)

2" Trim Meter

Magnetic type gauge shows trim angle for optimum performance and efficiency.

34800-93J00 Black

2" Hour Meter

12 volt electric motor driven meter indicates the number of hours your outboard motor has been operated to indicate when periodic services are necessary.

34500-93J00 Black

2" Fuel Gauge

Operates on 12 volts with magnetically damped needle. Works with most fuel tank sending units.

34300-93J00 Black

2" Voltmeter

A well charged battery is essential for quick and easy starts. Monitor the charging system using a Voltmeter.

34600-93J00 Black

2" Water Pressure Gauge 15 psi

Bourdon-tube type gauge measures cooling water pressure. Instructions and dash installation hardware included. Order Installation kit for appropriate model.

34650-93J20 Black

Water Pressure Gauge Installation Kits

Kit includes fittings and hoses needed for motor to gauge connection.

34660-93J00	DF200/225/250	34660-96J00	DF150/175
34660-99E00	DF60/70	34660-87J00	DF40/50
34660-90J02	DF40A/50A/50AV/60A/60AV/70A/80A/90/90A/115/115A/140/140A		

Suzuki Instruments

Suzuki Genuine Instruments are custom-designed to provide the quality, reliability and value you expect from Suzuki Products. The wide selection allows you to accurately monitor a variety of essential functions. All instruments are lighted for night time boating and feature standard 2" and 4" diameters for easy installation.



34200-93J50
4" Tachometer / Troll Mode



37860-87L00
Trolling Switch



34200-93J11
4" Tachometer / Monitor Gauge



34200-93J31
4" Tachometer



34100-93J11
4" Speedometer



34800-93J11
2" Trim Gauge



34500-93J11
2" Hour Meter



34300-93J11
2" Fuel Gauge



34600-93J11
2" Voltmeter



34650-93J31
2" Water Pressure Gauge

4" Tachometer With Suzuki Troll Mode Scale

Easy to read 4" Tachometer has a scale from 0-7,000 RPMs for standard use, and a secondary scale from 0-3,000 RPMs with markers at 50 RPM intervals for use with the Suzuki Troll Mode System*. Gauge also includes warning lamps for Engine Temperature, Low Oil, Check Engine and Over-Rev. When in troll mode, Over-Rev lamp stays on to indicate that Troll mode has been engaged. The secondary RPM scale is designed to make setting and maintaining a lower troll speed simple. Fits DF40A/50A/50AV/60A/60AV/70A/90A/115A/140A/150G/175G/250AP/300AP (DF300 requires SMIS gauges).

*See engine owner's manual for information about Suzuki Troll Mode system. Not all models come equipped with trolling mode system. Accessory Troll Mode Switch required for Suzuki Troll Mode System use. Suzuki recommends the use of this gauge for trolling use.

34200-93J50 DF40A/50A/50AV/60A/60AV/70A/90A/115A/140A/150G/175G/250AP/300AP (DF300 with SMIS gauges)

Trolling Mode Control Switch

Allows the use of the Suzuki Troll Mode on equipped engines. When Troll mode is engaged, this switch allows for adjustments of engine RPM in 50 RPM increments, from idle to 1200 RPM to make setting and maintaining a trolling speed easy. Consult owner's manual or Suzuki Outboard Dealer for additional details on Suzuki Troll System operation.

37860-87L00 trolling switch

4" Tachometers

7,000 max R.P.M. Tachs are available with or without 4-Stroke monitor functions. Monitor functions include: Low Oil Pressure Warning, Engine Temperature Warning, Check Engine Warning and Over-Rev Limit Warning.

34200-93J11 with monitor functions 34200-93J31 without monitor

4" Speedometers

Bourdon-tube type speedometer with readings in M.P.H. and Km/h. Includes vinyl tube, plus all installation instructions and hardware.

*Pitot tube 34190-87D00 must be ordered separately for DF50 and under models.

34100-93J11 80 mph 34100-93J31 50 mph (not shown)

34190-87D00* Pitot Tube (not shown)

2" Trim Meter

Magnetic type gauge shows trim angle for optimum performance and efficiency.

34800-93J11 White

2" Hour Meter

12 volt electric motor driven meter indicates the number of hours your outboard motor has been operated to indicate when periodic services are necessary.

34500-93J11 White

2" Fuel Gauge

Operates on 12 volts with magnetically damped needle. Works with most fuel tank sending units.

34300-93J11 White

2" Voltmeter

A well charged battery is essential for quick and easy starts. Monitor the charging system using a Voltmeter.

34600-93J11 White

2" Water Pressure Gauge 15 psi

Bourdon-tube type gauge measures cooling water pressure. Instructions and dash installation hardware included. Order Installation kit for appropriate model.

34650-93J31 White

Water Pressure Gauge Installation Kits

Kit includes fittings and hoses needed for motor to gauge connection.

34660-93J00 DF200/225/250 34660-96J00 DF150/175

34660-99E00 DF60/70 34660-87J00 DF40/50

34660-90J02 DF40A/50A/50AV/60A/60AV/70A/80A/90A/90A/115/115A/140/140A

Suzuki Precision Control

Suzuki's flagship DF150G/175G/250AP/300AP 4-stroke leads in power, performance and technology. Following are some high-tech items to help take advantage of Suzuki's leading edge technology.



67200-98J13
Dual Engine SPC Box

67200-98J03
Single Engine SPC Box

Suzuki Precision Control (SPC) Electronic Throttle And Shift Systems For DF150G/175G/250AP/300AP

Suzuki Precision Control (SPC) offers DF150G/175G/250AP/300AP boaters the latest in technologically advanced control systems. Suzuki Precision Control is a computer-based electronic "Fly-by-Wire" system eliminating mechanical control cables. While you enjoy smooth, friction-free throttle operation, the system's computer is processing and transmitting commands in real-time to actuators at the engine delivering precise throttle control with smooth, decisive shifting

SPC Box Only (Replacement Units)

67200-98J03	Single Engine SPC Box only
67200-98J13	Dual and Triple Engine SPC Box only
67200-98J22	Flush Mount SPC Box only

Single Engine SPC Kits

	67000-98J67 Flash-Mount Station Kit	67000-98J08 Binacle Station Kit	67000-98J18 Dual Station Kit
67200-98J03	Binacle-Mount RC Box	1	1
67200-98J22	Flash-Mount RC Box	1	
37100-98J03	Main Power Key Switch Assy	1	
37100-98J11	Single Engine Control Panel Assy	1	1
38500-93J90	Warning Buzzer	1	1
09407-08401	Warning Buzzer Clamp	1	1
37803-93J03	Emergency Switch Panel		1
36625-98J10	Battery Lead	1	
36770-98J10	Boat Control Module (BCM)	1	1
36775-98J00	BCM Holder (L)	1	1
36776-98J00	BCM Holder (R)	1	1
33911-88BLO	BCM-Connect Cap	1	1
33925-93J00	BCM Cushion	1	1
36623-98J20	BCM #1 Wiring Harness	1	
36624-98J02	BCM #2 Wiring Harness		1
36622-98J00	Dual Station Main Harness		1
33926-98J00	Terminal Resistor	2	
09403-13402	Harness Clamp	10	10
37860-87L00	Troll Mode Switch Panel	1	1

Dual Engines SPC Kits

	67000-98J28 Single Station Kit	67000-98J38 Dual Station Kit
67200-98J13	Binnacle-Mount RC Box	1
37100-98J03	Main Power Key Switch Assy	1
37100-98J21	Dual Engine Control Panel Assy	1
38500-93J90	Warning Buzzer	1
09407-08401	Warning Buzzer Clamp	1
37803-93J03	Emergency Switch Panel	1
36625-98J10	Battery Lead	1
36770-98J10	Boat Control module (BCM)	1
36775-98J00	BCM Holder (L)	1
36776-98J00	BCM Holder (R)	1
33925-93J00	BCM Cushion	1
36623-98J30	BCM #1 Wiring Harness	1
36624-98J11	BCM #2 Wiring Harness	1
33926-98J00	Terminal Resistor	2
36621-98J00	Dual Engine Single Station Harness	1
36622-98J00	Dual Station Main Harness	1
09403-13402	Harness Clamp	15
37860-87L00	Troll Mode Switch Panel	1

Triple Engines SPC Kits

	67000-98J48 Single Station Kit	67000-98J58 Dual Station Kit
67200-98J13	Binnacle-Mount RC Box	1
37100-98J03	Main Power Key Switch Assy	1
37100-98J31	Triple Engine Control Panel Assy	1
38500-93J90	Warning Buzzer	1
09407-08401	Warning Buzzer Clamp	1
37803-93J03	Emergency Switch Panel	1
36625-98J10	Battery Lead	1
36770-98J10	Boat Control module (BCM)	1
36775-98J00	BCM Holder (L)	1
36776-98J00	BCM Holder (R)	1
33925-93J00	BCM Cushion	1
36623-98J30	BCM #1 Wiring Harness	1
36624-98J11	BCM #2 Wiring Harness	1
33926-98J00	Terminal Resistor	2
36621-98J10	Triple Engine Single Station Harness	1
36622-98J00	Dual Station Main Harness	1
09403-13402	Harness Clamp	18
37860-87L00	Troll Mode Switch Panel	1

Quadruple Engines SPC Kits

	67000-98J70 Single Station Kit	67000-98J80 Dual Station Kit
67200-98J13	Binnacle-Mount RC Box	1
37100-98J03	Main Power Key Switch Assy	1
37100-98J21	Dual Engine Control Panel Assy	2
38500-93J90	Warning Buzzer	2
09407-08401	Warning Buzzer Clamp	2
37803-93J03	Emergency Switch Panel	1
36625-98J10	Battery Lead	2
36770-98J20	Boat Control module (BCM)	2
36775-98J00	BCM Holder (L)	2
36776-98J00	BCM Holder (R)	2
33925-93J00	BCM Cushion	2
36623-98J40	BCM Quadruple Wiring Harness	1
33926-98J00	Terminal Resistor	4
36621-98J00	Dual Engine Single Station Harness	2
36622-98J00	Dual Station Main Harness	2
09403-13402	Harness Clamp	20
37860-87L00	Troll Mode Switch Panel	1



67200-98J22
Flush Mount SPC Box

Suzuki Precision Control

Suzuki's flagship DF150G/175G/250AP/300AP 4-stroke leads in power, performance and technology. Following are some high-tech items to help take advantage of Suzuki's leading edge technology.



37100-98J11
Single Engine Control Panel Assy



37100-98J21
Dual Engine Control Panel Assy



37100-98J31
Triple Engine Control Panel Assy

Suzuki Control Panel Assemblies

For DF150G/175G/250AP/300AP

Control Panel Assemblies

Single to multiple engine, single or second station, select the panel needed for your application.

37100-98J11	Single Engine Control Panel Assy
37100-98J21	Dual Engine Control Panel Assy
37100-98J31	Triple Engine Control Panel Assy
37100-98J21 x2	Quad Engine Control Panel Assy

Requires Main Switch Assembly 37100-98J03.

Emergency Stop Switch Panel Assembly

Includes: Emergency Stop Switch with Panel and Lanyard. Required at each station.

37803-93J03	Emergency Stop Switch Panel Assy
-------------	----------------------------------

Main Power Key Switch Assembly

Main Power Key Switch required for use with switch control panels listed above. Includes key.

37100-98J03	Main Power Key Switch Assembly
-------------	--------------------------------

Battery Isolator Lead Set (not shown)

Used for charging auxiliary battery.

33830-98J01	DF300 only
33830-98J10	DF150G/175G/250AP/300A/300AP

Wiring Harnesses (not shown)

Main Wiring Harness. Order length as needed for rigging applications.

36620-98J30	21' (6.5m) Wiring Harness
36620-98J40	31' (9.5m) Wiring Harness
36620-98J50	6.5' (2m) Wiring Harness Extension (Optional; order as needed)

Replacement Wiring Harness (not shown)

36621-98J00	Dual Engine Single Station Harness
36621-98J10	Triple Engine Single Station Harness
36622-98J00	Dual Station Main Harness
36770-98J00	Boat Control Module (BCM)
36623-98J20	BCM Harness No1 for Single Engine Single Station
36623-98J30	BCM Harness No1 for Multiple Engines Single Station
36624-98J02	BCM Harness No 2 for Single Engine Second Station
36624-98J11	BCM Harness No 2 for Multiple Engine Second Station
36623-98J40	BCM Quadruple Harness



37803-93J03
Emergency Stop Switch Panel Assy



37100-98J03
Main Power Key Switch Assembly

Suzuki Instruments

Economically priced, high quality instruments feature easy plug-in wiring connections, perimeter-lighted dial, polished stainless steel bezels, contoured pointers and fog resistant glass lenses. All use standard 2" or 4" diameters for easy dash installation.



67000-93J14
Dual Binnacle Control Box Kit

67200-93J06
Side Mount Control Box Kit

67000-93J04
Single Binnacle Control Box Kit



67000-93J21
Flush Mount Control Box Kit



67500-93J00
Single Binnacle Control Box Spacer



67500-93J10
Dual Binnacle Control Box Spacer

Deluxe Single Binnacle Control Box Kit

Deluxe single Binnacle Control Box uses a convenient thumb-operated power trim and tilt switch, push-button shifting disengagement for faster warm ups and built-in neutral safety switch. Kit includes items listed. *Main Wiring Harness must be ordered separately.

67000-93J04* Single Binnacle Control Box Kit - includes:

37100-96J23	Ignition Switch Panel with Emergency Stop and Warning Buzzer Assembly
67200-93J13	Deluxe Single Binnacle ControlBox Assembly

Deluxe Dual Binnacle Control Box Kit

Deluxe Dual Binnacle Control Box includes the same features as the Single Binnacle Control Box, plus a unique base mounted PTT system allowing you to trim the motors individually then adjust them together for maximum performance. Kit includes items listed. *Main Wiring Harness must be ordered separately.

67000-93J14* Dual Binnacle Control Box Kit - Includes:

37100-96J13	Dual Ignition Switch with Emergency Stop
38500-92X50	Warning Buzzers (2)
67200-93J23	Deluxe Dual Binnacle Control Box Assembly

Deluxe Flush Mount Binnacle Control Box Kit

Suzuki's top quality Flush Mount Control Box features include a smooth action, thumb control power trim and tilt switch, a push button to disengage the shifting for faster warm-ups and a built in neutral safety switch. Reversible for left hand installations. Kit includes items listed. *Main Wiring Harness must be ordered separately.

67000-93J21* Flush Mount Binnacle Control Box Kit - Includes:

37100-96J23	Ignition Switch Panel with Emergency Stop and Warning Buzzer Assembly
67200-93J32	Deluxe Flush Mount Control Box

Replacement Control Boxes

67200-93J13	Single Binnacle Control Box	'05 - Current
67200-93J23	Dual Binnacle Control Box	'05 - Current
67200-93J32	Flush Mount Control Box	'05 - Current

Miscellaneous Components

38500-92X50	Warning Buzzer. Replacement Warning Buzzer for DF models.
36620-93J20	Control Box Adaptor. Adapts 2005+ model control box with square connector to 2004 and earlier motors with round connector.
36620-93J30	Wire Harness Adaptor. Adapts 2005+ model engine with square connector to 2004 and earlier harness with round connector.
67500-93J00	Single Binnacle Control Box Spacer
67500-93J10	Dual Binnacle Control Box Spacer

Side Mount Control Box Kits

Side Mount Control Boxes can be tailored to your needs. Standard features include a fast idle lever for easy warm-ups, a key-type ignition switch, an emergency stop switch and a 21' wiring harness.

67200-91J01	DF4/6	'03 - '10
67200-89E32	DF9.9/15	'97 - '04
67200-94J12*	DF9.9/15	'05 - '10
	DF8A/9.9A	'10 - Current
	DF25 V-Twin	'06 - Current
67200-99E52	DF25/30	'00 - '04
67200-94J12**	DF25/30	'05 - '08
67200-99E53	DF40/50	'99 - '04
	DF60/70	'98 - '04
	DF90/115/115A/140/140A	'01 - Current
67200-93J06**	DF40/50	'05 - '10
	DF40A/50A/50AV/60A/60AV	'10 - Current
	DF60/70	'05 - '10
	DF70A/80A/90A	'10 - Current
	DF90/115/140	'05 - Current
	DF150/175	'06 - Current
	DF200/225/250	'05 - Current

* Requires 36620-94J01 - Main Harness

**Requires 36620-93J52 - 16' Main Wire Harness

36620-93J02 - 21' Main Wire Harness

36620-93J62 - 26' Main Wire Harness

Cables and Rigging



37860-87L00
Trolling Switch



37805-93J00
PTT Switch Panel



37100-96J00
Single Engine Switch Panel



37803-93J03
Emergency Stop Switch Panel

37100-96J23
Single Ignition and Emergency Stop Switch Panel



37100-96J13
Dual Ignition and Emergency Stop Switch Panel



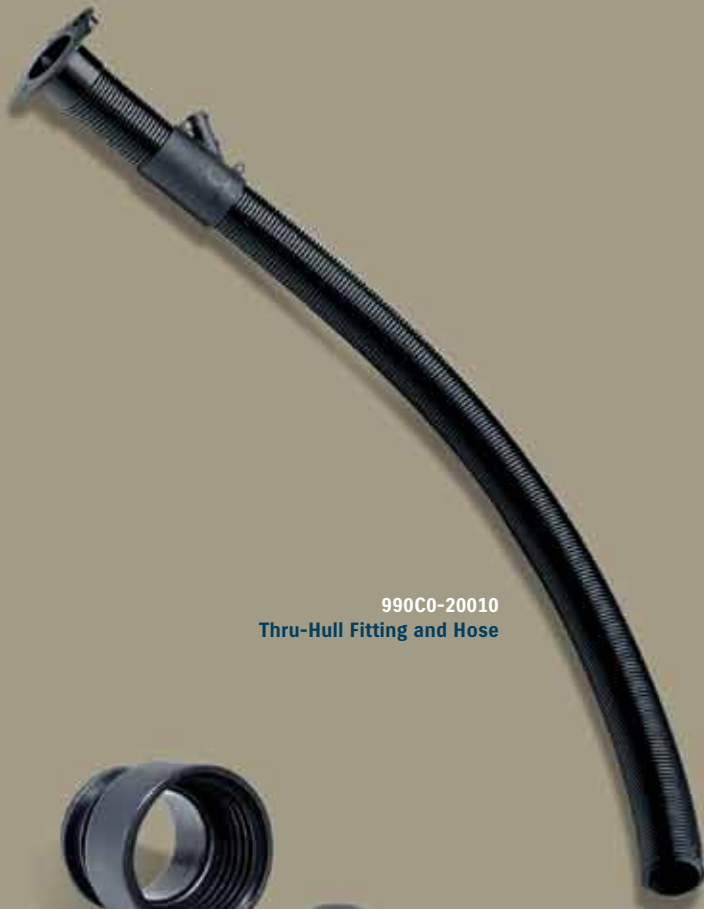

990C0-20010
Thru-Hull Fitting and Hose



67300-93J00
Adapter Kit



37823-92E01
Replacement Lanyard



Suzuki Performance Remote Control Cables

Black HDPE super tough casing

Oil tempered reinforced lay wire for high strength and flexibility

Heavy-duty HDPE inner liner for minimal drag and long life

Splined core for high efficiency and minimal backflash

Switch Panels Assemblies

Genuine Suzuki Switch Panel assemblies are designed to match and connect with other Suzuki components for easy installation and trouble-free operation.

37100-96J00	Single Engine Ignition Switch Panel Assembly. Includes wiring and hardware.
37100-96J23	Single Engine Ignition and Emergency Stop Switch Panel Assembly. Includes wiring, hardware and stop switch lanyard.
37100-96J13	Dual Engine Ignition and Emergency Stop Switch Panel Assembly. Includes wiring, hardware and stop switch lanyard.
37860-87L00	Trolling Switch allows the use of the Suzuki Troll Mode on equipped engines.
37805-93J00	P.T.T. Switch Panel Assembly. Includes wiring and hardware.
37803-93J03	Emergency Stop Switch Panel Assembly. Includes wiring, hardware and lanyard.

Wiring Harness (not shown)

Main Wiring Harness. Order length as needed for rigging applications.

36620-93J52	16' Wiring Harness	36620-93J02	21' Wiring Harness
36620-93J62	26' Wiring Harness	36620-93J10	6' Wiring Harness Ext.
36620-93J40	10' Wiring Harness Extension		

Battery Isolator Lead Set (not shown)

Used for charging auxiliary battery.

33830-96J00	DF150/175	33830-98J01	DF300
33830-98J10	DF250A/300A/300AP		

Aux Power Trim Switch Lead Connection Adapter (not shown)

Allows quick connection of remote trim switch with easy plug in connectors. 36647-93J00

Replacement Ignition Keys (not shown)

37141-99EA0	key 941	37141-99E20	Key 933	37141-99E60	Key 937
37141-99EB0	Key 942	37141-99E30	Key 934	37141-99E70	Key 938
37141-99E00	Key 931	37141-99E40	Key 935	37141-99E80	Key 939
37141-99E10	Key 932	37141-99E50	Key 936	37141-99E90	Key 940

Thru-Hull Fitting And Hose Kit 2006-2011 Models*

Thru-Hull fitting and Hose kit can handle single, dual and triple motor installations. One kit is necessary for each motor used.

990C0-20010 Kit for 2006 - Current Models

Kit Includes: 1 - 4' Black Hose
1 - Fuel Hose Port1 - 2" Thru-Hull Fitting
2 - Stainless Steel Bolts and Nuts

Adapter Kit	67300-93J00**	DF150/175/200/225/250/300
	67300-90J00**	DF70A/80A/90A/100/115/140

*NOTE: Will not fit 2004-2005 DF Motors. When attaching the rigging tube to the motor, an **Adapter Kit is also required for each motor.

Replacement Lanyard

37823-92E01 Replacement Lanyard for Emergency Stop Switch.

Suzuki Performance Remote Control Cables

Suzuki Performance Cables have a unique design that incorporates a patent-pending splined core. Ridges on the core to allow a close fit to the cable's inner liner with minimum contact, allowing the core to glide back and forth smoothly. All cables are factory tested and approved for heavy use applications. Order cable length as needed.

99105-11002-008	8'	99105-11002-016	16'	99105-11002-024	24'
99105-11002-009	9'	99105-11002-017	17'	99105-11002-025	25'
99105-11002-010	10'	99105-11002-018	18'	99105-11002-026	26'
99105-11002-011	11'	99105-11002-019	19'	99105-11002-027	27'
99105-11002-012	12'	99105-11002-020	20'	99105-11002-028	28'
99105-11002-013	13'	99105-11002-021	21'	99105-11002-029	29'
99105-11002-014	14'	99105-11002-022	22'	99105-11002-030	30'
99105-11002-015	15'	99105-11002-023	23'		

Steering

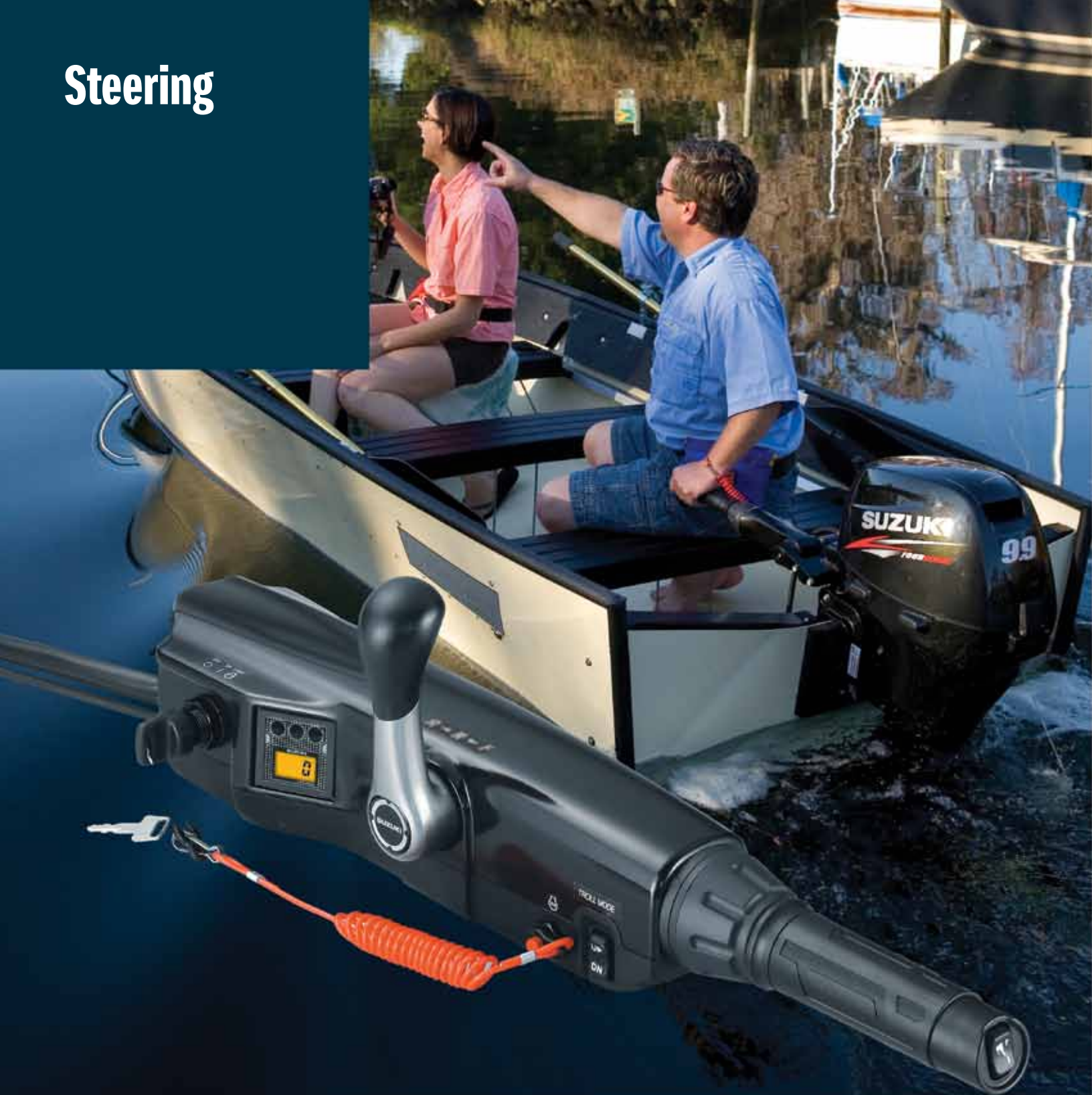

Angle Adjustable Bracket



Digital Tachometer



Shift Lever

63002-88L20-0EP
Tiller Handle Kit



63001-94J02-0EP
Tiller Handle Kit



67701-93E12
Drag Link Kit



99105-10006
Dual Engine Tie Bar



99105-10004
Dual Cable Steering Kit



99105-10005
Twin Engine Adapter Plate Set

New Tiller Handle Kits

New fully-integrated tiller handle with digital tachometer display. Includes redesigned, more ergonomic shift lever.

63002-88L20-0EP	DF40A/50A	'10 - Current
63002-88L10-0EP	DF60A	'10 - Current
63002-87L10-0EP	DF70A/80A/90A	'09 - Current
63002-90J30-0EP	DF115A w/ Adjustable Steering Damper	

Tiller Handle Kits

Tiller Handle Kits are designed for easy installation for selected electric start models. Kit includes ignition switch, engine stop switches, wiring harness, cables and grommets.

63001-94J02-0EP	DF9.9/15	'05 - '09
63002-87J26-0EP	DF40/50	'05 - '09
63002-99E24-0EP	DF60 w/ Steering Tensioner	'05 - '09
	DF70 w/ Steering Tensioner	'05 - '08
63002-88L06-0EP	DF40A/50A/60A	'10 - Current
63002-88L20-0EP	DF40 - 115A	'13 - Current
63002-87L03-0EP	DF70A/80A/90A	'09 - Current
63002-90J26-0EP	DF90/115 w/ Hydraulic Tensioner	'05 - Current

Drag Link Kits

Corrosion-resistant stainless steel Drag Links are specially designed for use with Suzuki Outboard Motors.

67701-94JA0	DF9.9T	'08 - Current
67701-99J00	DF8A/9.9A	'10 - Current
67701-93E12	DF9.9/15	'97 - '10
67701-89J20	DF25/30	'00 - '07
67701-95J00	DF25 V-Twin	'06 - Current
67701-87J11	DF40/50 40A/50A/60A DF60/70	'99 - '10 '10 - Current '98 - '10
67701-87L00	DF70A/80A/90A	'09 - Current
67701-90J00	DF90/115/140A	'01 - Current
67701-96J00	DF150/175	'06 - Current
67700-93J00	DF200/225/250/300	'04 - Current

Dual Engine Tie Bar

Stainless steel Tie Bar for dual engine steering, adjustable up to 36".

99105-10006	DF40 - DF140A
-------------	---------------

Dual Cable Steering Kit

Kit allows you to attach two steering cables for added reliability.

99105-10004	DF150 - DF250
-------------	---------------

Twin Engine Adapter Plate Set

Adapter plates are used when installing a tie bar on a DF90/115/140.

99105-10005	DF90/115/140A
-------------	---------------

Fuel System



99105-20006-ASY
Compact Water Separator / Fuel Filter

99105-20005-ASY
Water Separator / Fuel Filter



65000-95J01
Plastic Fuel Tank - 6.6 gal



65000-99J01
Plastic Fuel Tank - 3 gal



Fuel Hose

Water Separator/Fuel Filter

State-of-the-art filter removes water and other contaminants from the fuel before they reach your engine. It features a transparent removable bowl for easy viewing of fuel condition and a drain valve for water and other impurities. Due to the high flow rate capabilities of this filter system, a special large diameter thread is used. Use only Genuine Suzuki Replacement Filter 99105-20005.

99105-20005	Replacement Filter
99105-20005-ASY	Complete Assembly
99105-20004-BWL	Bowl and Drain Valve Assembly

Compact Water Separator/Fuel Filter

Compact size Water Separator/Fuel Filter is ideal for smaller boat-motor combinations of up to 140 H.P. Not for V6 Models.

99105-20006	Replacement Filter
99105-20006-ASY	Complete Assembly
99105-20006-BWL	Bowl and Drain Valve Assembly

Plastic Fuel Tanks*

Constructed of tough, lightweight, high-density polyethylene and made to CARB / EPA standards.

65000-99J01	3 Gallon Tank without Fuel Level Gauge
65000-95J01	6.6 Gallon Tank with Fuel Level Gauge
65520-95J00	Replacement Fuel Cap

* not for use with DF 4/6 without fuel hose with pressure regulator see dealer for details.

Fuel Hose

Fuel Hose selection depends on your motor and fuel tank. Please consult your local Suzuki Dealer.

Fuel Connectors - Motor Side

Male connectors are located on the motor side, for fuel hose attachment.

65720-98520	OD:11mm	Plated Brass	DT3.5 - 65
65720-95511	OD:13mm	Plated Brass	DT75 - 140A
65720-94401	OD:13mm	Plastic	DT4 - 65
65720-94411	OD:13mm	Plastic	DT75 - 140A
65720-986B0		Plastic	DF4 - 140A
65721-87D00	OD:13mm	Plastic	DT150 - 225 (not hown)

Fuel Hose Connectors

Quick connect and disconnect female fittings fit either hose end.

65750-98505	ID:11mm	Metal for small diameter hoses	
65750-93000	ID:13mm	Metal for small diameter hoses	
65750-95500	ID:13mm	Metal for small diameter hoses	
65750-94404	ID:13mm	Plastic	DT4 - 140A
65750-87J11		Plastic	DF4 - 140A

Fuel Tank Connectors

Fuel tank connectors are available in stainless steel with metric thread and plated brass with 1/4" NPT.

65720-98590	OD:11mm	Metric	All Models
65740-95500	OD:13mm	Metric	All Models
99105-00192	OD:11mm	1/4" NPT	U.S. Tanks
99105-00193	OD:13mm	1/4" NPT	U.S. Tanks



65720-98520
Fuel Connector - Motor Side



65750-98505
Fuel Hose Connector



65720-95511
Fuel Connector - Motor Side



65750-93000
Fuel Hose Connector



65720-98590
Fuel Tank Connector



65720-94401
Fuel Connector - Motor Side



65750-95500
Fuel Hose Connector



65740-95500
Fuel Tank Connector



65720-94411
Fuel Connector - Motor Side



65750-94404
Fuel Hose Connector



99105-00192
Fuel Tank Connector



65720-986B0
Fuel Connector - Motor Side



65750-87J11
Fuel Hose Connector



99105-00193
Fuel Tank Connector

Propellers

Propeller selection is very important in the performance of your boat. Acceleration, speed, fuel efficiency, stability and engine RPM all are affected by the propeller selected. Operating requirements and conditions will also affect which design, style and pitch of propeller you may choose to meet your individual needs. The boat and engine combination may have already been tested by your dealer or the boat manufacturer for the appropriate propeller size. Your Suzuki Dealer can assist you with the process to determine the correct propeller for your application.



Diameter

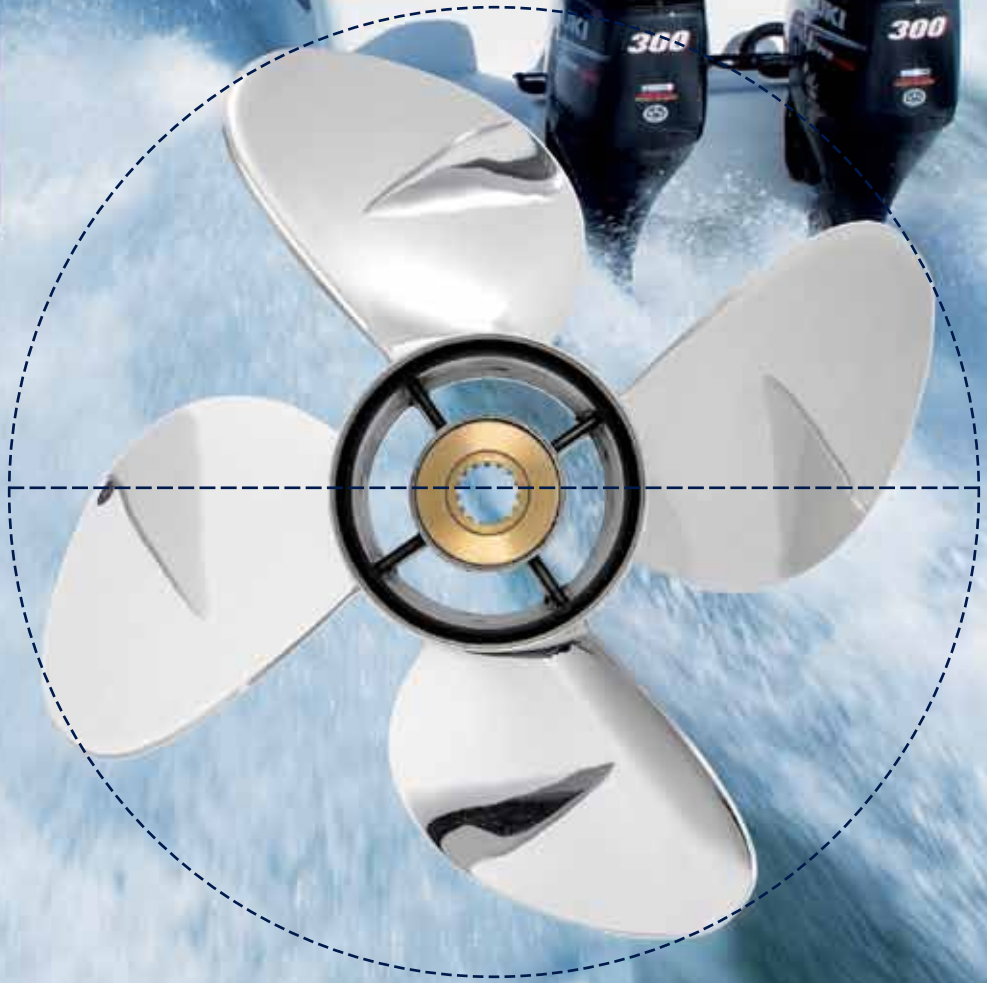

Pitch

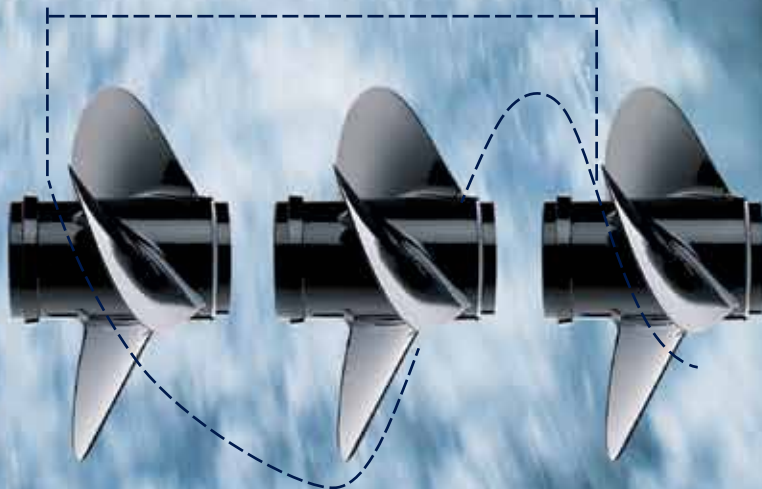

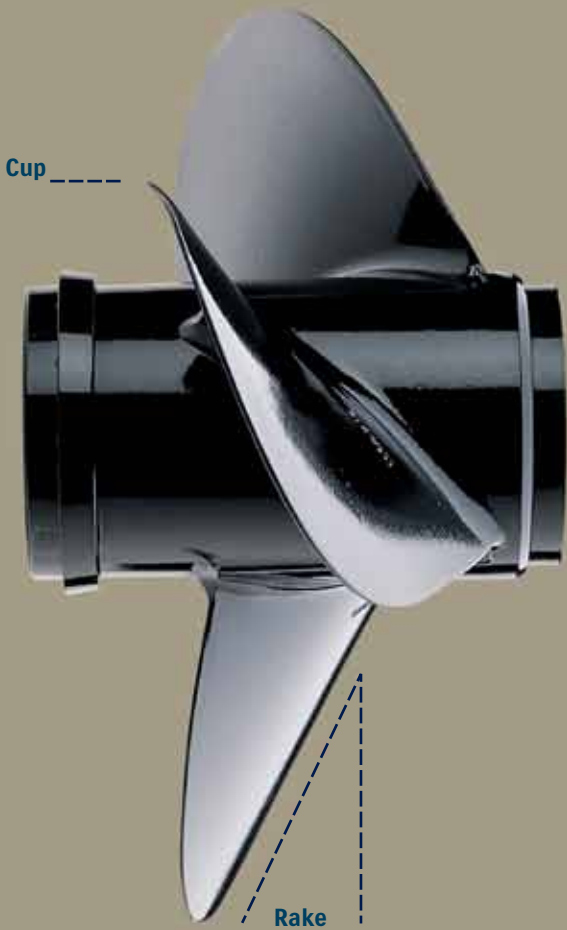

Stainless Steel Propellers

Suzuki Stainless Steel Propellers offer higher performance and greater durability than aluminum propellers. The aggressive design of these propellers enhances the overall performance of your boat and the durability of the stainless steel construction will give you long term dependability. Your Suzuki Stainless Steel propeller is also fitted with a rubber cushion hub to help absorb vibration and shock should you strike a foreign object.

Propeller Sizing

When referring to propeller size, such as 3 x 13 x 18, the first number details the diameter of the propeller and the second number is the pitch of the propeller. The pitch is the most significant number in the description. The diameter is usually predetermined by the propeller engineers and is based on the size and series of the engine.

Diameter

Diameter is considered to be the distance across an imaginary circle that is made when a propeller is rotated. Diameter is determined during the engineering process of designing a propeller and is usually based on requirements to meet the needs of engine size, gear case design, horsepower and speed.

Pitch

Pitch is used to describe the theoretical distance that a propeller “cork screws” through the water in inches of forward travel. In theory, an 18” pitch propeller would move ahead 18” with each complete revolution of a propeller. There is always some percentage of inefficiency as water conditions, boat weight and propeller style are introduced into the performance equation. The lower the “slip factor,” the more efficiently the propeller will perform and the faster the speed at a given engine RPM. Lower pitches accelerate faster, but have a lower top end speed. Higher pitches have a slower acceleration, but may attain higher top speeds. An inch of pitch generally is equal to 150 – 200 engine RPM at wide open throttle (WOT). If pitch is increased by an inch, RPM will decrease by 150 – 200 RPM at WOT. If pitch is decreased by an inch, RPM will increase by 150 – 200 RPM at WOT. Always operate your boat/engine combination within the recommended RPM range guidelines as stated in your operator’s manual. Operating outside the recommended range can cause severe damage to your engine and may void the engine warranty.

Propeller Cup

Cup is used to reduce the slip and ventilation of the propeller. This will allow you to operate your engine at a higher transom mounting and allow you to use more trim for bow lift. The cup refers to the area along the trailing edge of the propeller blade that has an increased pitch in the last 1/2” of the blade surface and extends to the blade tip.

Rake

Rake is described as the angle, in degrees, that the propeller blades are mounted to the “barrel” of the propeller. The blades of a zero degree rake propeller are mounted perpendicular to the “barrel” of the propeller. The blades of a higher rake propeller angle more to the rear of the propeller. A propeller with a high rake design will hold the water on the blades longer during operation and will ventilate less at higher engine heights. High rake propellers will produce higher thrust that will help lift the bow of the boat more effectively.



99105-30003
Propeller Lock



57630-92E00
Propeller Hardware Kit

Propeller Lock 99105-30003 DF40 – 300AP

Propeller Hardware Kit		57630-99J00	DF8A/9.9A
57630-94500	DF60/70 with V-Style		
57630-93900	DF9.9/15C	57630-90J00	DF70A/80A/90A
57630-96300	DF25/30	57630-90J00	DF90 – 140
57630-94300	DF40/50/60A	57630-92E00	V-6
57630-90J00	DF50AV/60AV		

Propellers



DF4/6 (Optional '03-'10)

Type	Material	Blades	Diameter	Pitch	Part Number	DF4	DF6
C601	Aluminum	3	7-1/2	6	58110-91J00-019	'04-CURR	'04-CURR
C611	Aluminum	3	7-1/2	6-1/2	58110-91J10-019	'04-CURR	'04-CURR
C701	Aluminum	3	7-1/2	7	58110-91J20-019	'04-CURR	'04-CURR
	Aluminum	3	7-1/2	6	58111-98602-019	'03	
	Aluminum	3	7-1/2	6-1/2	58111-98641-019	'03	
	Aluminum	3	7-1/2	7	58111-98651-019	'03	

Diameter and pitch are measured in inches. ■=Optional. Type C does not include Propeller Bushing. Refer to the Bushing Application Chart.

DF8A/9.9A/9.9B/9.9/15

Type	Material	Blades	Diameter	Pitch	Part Number	DF8A/9.9A/9.9B	DF9.9/15
M701*	Aluminum	3	9-1/4	7	58100-93703-019	■	■
M801*	Aluminum	3	9-1/4	8	58100-91D00-019	■	■
M901*	Aluminum	3	9-1/4	9	58100-94J00-019	■	■
M1101*	Aluminum	3	9-1/4	11	58100-93743-019	■	■
M911*	Aluminum	3	9-1/4	9	58100-93763-019	■	■
M1011*	Aluminum	3	9-1/4	10	58100-93773-019	■	■
High Thrust	Aluminum	4	10	5	58100-94JA0-019		■

Diameter and pitch are measured in inches. ■=Optional.

Propeller Bushing Application

Type	Applications	Bushing Type	Bushing	Stopper	Spacer	Washer	Nut	
C	DF4/5	'03 Models	Push-In	58120-98600			58130-91JL0	
C	DF4/5	'04 - Current Models	Press-In	58120-91J00	57635-91JL0		58130-91JL0	
C	DF6	'03 - Current Models	Press-In	58120-91J00	57635-91JL0		58130-91J00	
M	DF9.9/15		Press-In	58120-93701	57632-93902	57633-93901	09160-12066	09141-12005
P	DF25/30	'00 - '07 Models	Press-In	58120-96401	57632-96400	57633-96300	09160-14028	09141-14008
P	DF25/V-Twin	'06 - Current Models	Press-In	58120-96401	57632-95J00	57633-96300	09160-14028	09141-14008
S	DF40/50		Press-In	58120-86L00	57632-93320	57633-94300	09160-18028	09141-18005
S	DF40A/50A/60A	'10 - Current Models	Press-In	58120-88L00	57632-93320	57633-94300	09160-18028	09141-18005
U	DF60/70		Press-In	58120-95500	57635-95510	57633-95501	09160-18028	09141-18005
V	DF60/70		Press-In	58120-94520	57635-94511	57633-94500	09160-18028	09141-18005
	DF70A/80A/90A	'09 - Current Models	Press-In	58120-90J00	57632-87L00	57633-90J02	09160-18028	09141-18005
90-140	DF90/115/140A		Press-In	58120-90J00	57635-90J01*	year specific	09160-18028	09141-18005
90-140	DF90/115/140	'01 - '02 Models	Press-In	58120-90J00	57635-90J01*	57633-90J02	09160-18028	09141-18005
90-140	DF90/115/140	'03 - '08 Models	Press-In	58120-90J00	57635-90J01*	57633-90J02	09160-18028	09141-18005
90-140	DF90/115/140A	Counter Rotation Models	Press-In	58120-90J00	57635-92J01*	year specific	09160-18028	09141-18005
150-300	DF150/175/200/225/250/250AP/300/300AP		Press-In	58105-93J00	57632-93J10	57633-87D30	09160-18028	09141-18005
250S	DF250S		Press-In	58105-93J00	57632-93J20	57633-87D30	09160-18028	09141-18005

*Use Spacer For Stopper, 57632-90J00

DF15A/20A

Type	Material	Blades	Diameter	Pitch	Part Number	DF15A/20A
	Aluminum	3	9-1/4	7	58100-89L00-019	■
	Aluminum	3	9-1/4	8	58100-90L40-019	■
	Aluminum	3	9-1/4	9	58100-89L20-019	■
	Aluminum	3	9-1/4	9	58100-90L50-019	■
	Aluminum	3	9-1/4	10	58100-89L30-019	■
	Aluminum	3	9-1/4	10	58100-90L60-019	■
	Aluminum	3	9-1/4	11	58100-89L40-019	■
	Aluminum	3	9-1/4	12	58100-89L50-019	■

Diameter and pitch are measured in inches. ■=Optional.

DF40A/50A/60A

Type	Material	Blades	Diameter	Pitch	Part Number	DF40A/50A/60A
	Aluminum	3	10-5/8	12	58100-88LA0	■
	Aluminum	3	11-1/2	13	58100-88LB0	■
	Aluminum	3	11-1/8	16	58100-88L30	■

Diameter and pitch are measured in inches. ■=Optional.

DF50AV/60AV

Type	Material	Blades	Diameter	Pitch	Part Number	DF50AV/60AV
	Aluminum	3	14	9	990C0-00750-09P	■
	Aluminum	3	14	11	990C0-00750-11P	■
	Aluminum	3	14	13	990C0-00750-13P	■
	Aluminum	3	13.9	15	990C0-00750-15P	■
	Aluminum	3	13.8	17	990C0-00750-17P	■

Diameter and pitch are measured in inches. ■=Optional.

DF40A/50A/60A/40/50

Type	Material	Blades	Diameter	Pitch	Part Number	'99 - CURR
S900	Aluminum	3	11-1/2	9	58100-88L03-019	■
S1000	Aluminum	3	11-1/2	10	58100-88L13-019	■
	Aluminum	3	11-5/8	12	58100-88L32-019	■
	Aluminum	3	11-1/2	13	58100-88L42-019	■
S1100	Aluminum	3	11-1/2	11	58100-88L23-019	■
S1200	Aluminum	3	11-5/8	12	58100-88L32-019	■
S1301	Aluminum	3	11-1/2	13	58100-88L42-019	■
S1400	Aluminum	3	11-3/8	14	58100-88L52-019	■
S1500	Aluminum	3	11-1/4	15	58100-88L62-019	■
S1600	Aluminum	3	11-1/8	16	58100-88L72-019	■
S1700	Aluminum	3	11	17	58100-88L83-019	■
	Stainless Steel	3	11-3/4	12	990C0-00501-12P	■
	Stainless Steel	3	11-3/4	13	990C0-00501-13P	■
	Stainless Steel	3	11-3/4	14	990C0-00501-14P	■
	Stainless Steel	3	11-3/4	15	990C0-00501-15P	■
	Stainless Steel	3	11-3/4	16	990C0-00501-16P	■
	Stainless Steel	3	11-3/4	17	990C0-00501-17P	■

Diameter and pitch are measured in inches. ■=Optional.

DF60/70

Type	Material	Blades	Diameter	Pitch	Part Number	'98 - '09
V1100	Aluminum	3	14	11	58100-99E10-019	■
V1300	Aluminum	3	13-3/4	13	58100-99E00-019	■
V1500	Aluminum	3	13-1/2	15	58100-94500-019	■
V1700	Aluminum	3	13-1/4	17	58100-94512-019	■
V1900	Aluminum	3	13	19	58100-94522-019	■
V2100	Aluminum	3	13	21	58100-94532-019	■
60-70	Stainless Steel	3	13-1/4	12	99105-00100-12P	■
60-70	Stainless Steel	3	13-1/4	14	99105-00100-14P	■
60-70	Stainless Steel	3	13-1/4	16	99105-00100-16P	■
60-70	Stainless Steel	3	13-1/4	18	99105-00100-18P	■
60-70	Stainless Steel	3	13-1/4	20	99105-00101-20P	■
60-70	Stainless Steel	3	13-1/4	22	99105-00101-22P	■

Diameter and pitch are measured in inches. Extremely durable stainless steel propellers especially designed for high performance boats. ■=Optional. Type V Cupped aluminum propeller with press-in b

DF70A/90A

Type	Material	Blades	Diameter	Pitch	Part Number	'09 - CURR
	Aluminum	3	14	13	58100-87LA0-019	■
	Aluminum	3	13-7/8	15	58100-87L10-019	■
	Aluminum	3	13-3/4	17	58100-87LC0-019	■
	Aluminum	3	13-3/4	19	58100-87LD0-019	■
	Aluminum	3	13-3/4	21	58100-87LE0-019	■
	Aluminum	3	13-3/4	23	58100-87L50-019	■
	Stainless Steel	3	14	16	99105-00700-16P	■
	Stainless Steel	3	14	18	99105-00700-18P	■
	Stainless Steel	3	14	20	99105-00700-20P	■
	Stainless Steel	3	14	22	99105-00700-22P	■

Diameter and pitch are measured in inches. ■=Optional.

DF50AV/60AV/90/115/115A/140/140A

Type	Material	Blades	Diameter	Pitch	Part Number	'01 - CURR
90-140	Aluminum	3	13-1/2	15	58100-90JE0-019	■
90-140	Aluminum	3	14	17	58100-90JA0-019	■
90-140	Aluminum	3	14	19	58100-90JB0-019	■
90-140	Aluminum	3	14	21	58100-90JC0-019	■
90-140	Aluminum	3	14	23	58100-90JD0-019	■
90-140	Stainless Steel	3	14	16	99105-00700-16P	■
90-140	Stainless Steel	3	14	18	99105-00700-18P	■
90-140	Stainless Steel	3	14	20	99105-00700-20P	■
90-140	Stainless Steel	3	14	22	99105-00700-22P	■
90-140	Stainless Steel	3	14	24	99105-00700-24P	■
90-140	Stainless Steel	3	14	26	99105-00700-26P	■
90-140	Stainless Steel	3	14	28	99105-00700-28P	■

Counter Rotation Models

115-140	Stainless Steel	3	14	18	99105-0070L-18P	■
115-140	Stainless Steel	3	14	20	99105-0070L-20P	■
115-140	Stainless Steel	3	14	22	99105-0070L-22P	■
115-140	Stainless Steel	3	14	24	99105-0070L-24P	■

Diameter and pitch are measured in inches. ■=Optional.

DF150 - 300AP

Type	Material	Blades	Diameter	Pitch	Part Number	DF150 - 300AP
150-175	Stainless Steel	3	15-1/2	17	990C0-00830-17P	■
150-175	Stainless Steel	3	15-1/4	19	990C0-00830-19P	■
150-175	Stainless Steel	3	15	21	990C0-00830-21P	■
150-175	Stainless Steel	3	14-3/4	23	990C0-00830-23P	■
150-175	Stainless Steel	3	14-1/2	25	990C0-00830-25P	■
150-175	Stainless Steel	3	14-1/2	27	990C0-00830-27P	■
150-175	Stainless Steel	4	14-3/8	23	990C0-00834-23P	■
150-175	Stainless Steel	4	14-3/8	25	990C0-00834-25P	■
150-175	Stainless Steel	4	14-3/8	27	990C0-00834-27P	■
150-175	Stainless Steel	4	14-3/8	28	990C0-00834-28P	■
150-175	Stainless Steel	4	14-3/8	29	990C0-00834-29P	■
00-300	Stainless Steel	3	16	17	99105-00800-17P	■
200-300	Stainless Steel	3	16	18-1/2	99105-00800-185	■
200-300	Stainless Steel	3	16	20	99105-00800-20P	■
200-300	Stainless Steel	3	16	21-1/2	99105-00800-215	■
200-300	Stainless Steel	3	16	23	99105-00800-23P	■
200-300	Stainless Steel	3	16	24-1/2	99105-00800-245	■
200-300	Stainless Steel	3	16	26	99105-00800-26P	■
200-300	Stainless Steel	3	16	27-1/2	99105-00800-275	■
200-300	Stainless Steel	4	15	20	990C0-00840-20P	■
200-300	Stainless Steel	4	15	22	990C0-00840-22P	■
200-300	Stainless Steel	4	15	24	990C0-00840-24P	■
200-300	Stainless Steel	4	15	26	990C0-00840-26P	■

Counter Rotation Models

150-175	Stainless Steel	3	15-1/2	17	990C0-0083L-17P	■
150-175	Stainless Steel	3	15-1/4	19	990C0-0083L-19P	■
150-175	Stainless Steel	3	15	21	990C0-0083L-21P	■
150-175	Stainless Steel	3	14-3/4	23	990C0-0083L-23P	■
150-175	Stainless Steel	3	14-1/2	25	990C0-0083L-25P	■
150-175	Stainless Steel	3	14-1/2	27	990C0-0083L-27P	■
200-300	Stainless Steel	3	16	17	99105-0080L-17P	■
200-300	Stainless Steel	3	16	18-1/2	99105-0080L-185	■
200-300	Stainless Steel	3	16	20	99105-0080L-20P	■
200-300	Stainless Steel	3	16	21-1/2	99105-0080L-215	■
200-300	Stainless Steel	3	16	23	99105-0080L-23P	■
200-300	Stainless Steel	3	16	24-1/2	99105-0080L-245	■
200-300	Stainless Steel	3	16	26	99105-0080L-26P	■
200-300	Stainless Steel	4	15	20	990C0-0084L-20P	■
200-300	Stainless Steel	4	15	22	990C0-0084L-22P	■
200-300	Stainless Steel	4	15	24	990C0-0084L-24P	■
200-300	Stainless Steel	4	15	26	990C0-0084L-26P	■

Diameter and pitch are measured in inches. ■=Optional.

DF250SS

Type	Material	Blades	Diameter	Pitch	Part Number	DF250S
	Stainless Steel	3	14-3/4	29	990C0-00930-29P	■
	Stainless Steel	3	14-3/4	30	990C0-00930-30P	■
	Stainless Steel	3	14-3/4	31	990C0-00930-31P	■
	Stainless Steel	3	14-3/4	32	990C0-00930-32P	■
	Stainless Steel	4	14-1/2	26	990C0-00940-26P	■
	Stainless Steel	4	14-1/2	27	990C0-00940-27P	■
	Stainless Steel	4	14-1/2	28	990C0-00940-28P	■
	Stainless Steel	4	14-1/2	29	990C0-00940-29P	■
	Stainless Steel	4	14-1/2	30	990C0-00940-30P	■
	Stainless Steel	4	14-1/2	31	990C0-00940-31P	■

Diameter and pitch are measured in inches. ■=Optional.



Repair Kits / Zinc Anodes



17400-98661
Water Pump Repair Kit



25700-95D00
Gear Case Seal Kit

Water Pump Repair Kit

Repair kits include necessary parts to rebuild the water pump on the models listed.

17400-98661	DF4/6	'02 - '10
17400-986L0	DF4/6	'11 - Current
17400-99J00	DF8A/9.9A	'10 - Current
17400-94J10	DF9.9/15	'07 - Current
17400-93951	DF9.9/15	'97 - '06
17400-96353	DF25/30	'00 - '07
	DF40/50	'99 - '10
	DF25A/30A	'13 - Current
17400-95J02	DF25 V-Twin	'06 - Current
17400-99E01	DF60/70	'07 - '10
17400-87E04	DF60/70	'98 - '06
17400-88L00	DF40A/50A/60A	'10 - Current
17400-92J21	DF50AV/60AV	'14 - Current
17400-87L01	DF70A/80A/90A	'09 - Current
17400-92J00	DF90/115/140	'06 - '08
17400-90J20	DF90/115/140	'01 - '05
17400-92J21	DF100A/115/115A/140A	'09 - Current
17400-96J01	DF150/150G/175/175G	'06 - Current
17400-93J01	DF200/225/250	'04 - Current
17400-98J01	DF250S	'08 - Current
	DF300/300AP	'07 - Current
17400-98652	DT4	'84 - '98
	DT5	'99 - '02
17400-98551	DT6	'84 - '02
	DT8	'86 - '97
	DT9.9	'85 - '87
	DT15C	'89 - '97
	DT15	'83 - '88
17400-92D01	DT8C/9.9C	'88 - '97
17400-96403	DT25C	'89 - '00
	DT30C	'88 - '97
17400-96353	DT20	'86 - '88
	DT25	'84 - '88
	DF25/30	'00 - '07
	DT30	'84 - '87
	DT35/40C	'83 - '98
17400-94701	DT55/65	'85 - '97
17400-95351	DT75/85	'85 - '00
17400-94611	DT115/140	'86 - '01
17400-94553	DT115/140	'83 - '85
17400-87D11	V6 2-Stroke Models	'86 - '03

Gear Case Seal Kit

Gear Case Seal Kits include all necessary replacement seals and o-rings.

25700-95D01	DF25/30 (except V-Twin)	
25700-95J00	DF25 V-Twin	All
25700-88L00	DT40C/DF40/50/40A/50A/60A	All
25700-87E00	DF60/70 and V4 Models	'89 - '00
25700-99E00	DF60/70	'01 - '10
25700-87L00	DF70A/80A/90A	'09 - Current
25700-90J01	DF90/100/115	All
25700-92J00	DF140	All
25700-93J00	DF150/175/ 200/225/250	All
25700-98J00	DF250S/300	All
25700-95D00	DT25C/30C	All
25700-94700	DT55/65	All
25700-95501	DT75/85	All
25700-94500	DT115/140	All
25700-87D00	V6, 2-Stroke Models	'89 - '03

Carburetor Repair Kit

Carburetor Repair Kits include gaskets and float needle valve.

13910-89J01	DF25/30 (except V-Twin)	All
13910-95D00	DT25/30C	All
13910-94400	DT40/65/85/140	All
13910-94701	DT55/75/115	All
13910-87D00	V6, 2-Stroke Models	All

Magnesium Anodes For Freshwater Use Only

Magnesium anodes protect underwater metal components from galvanic corrosion in freshwater environment. Do not use in saltwater. For 2-Stroke applications check parts fiche.

55321-87J10	DF8A/9.9A	'10 - Current
	DF25 V-Twin	'06 - Current
	DF40A/50A/60A	'10 - Current
	DF70A/80A/90A	'09 - Current
	DF90/115	'01 - '08
	DF100/115	'09 - Current
	DF140	'02 - Current
	DF150/175	'06 - Current
	DF200/225/250	'04 - Current
	DF300	'07 - Current



55321-94910	DF60 thru 140	'01 - '10
	DF150/175/200	'06 - Current
	/225/250/300	



Aluminum Anodes For Brackish And/Or Saltwater

Do not use in freshwater.

55321-87J00	All Models	All Years
-------------	------------	-----------



Zinc Anodes For Saltwater Use Only

Easy to replace Zinc Anodes protect motor parts from galvanic corrosion in saltwater environment. Not for freshwater use. Note: Zinc Anodes should not be painted. For 2-Stroke applications check parts fiche.

11281-94400	DF60/70	'98 - '01
-------------	---------	-----------



41811-98500	DF9.9/15	'97 - '10
-------------	----------	-----------



55125-90J01	DF90-140	'98 - Current
-------------	----------	---------------



55125-98J00-0EP	DF200/225/250/300 Trim Tab	
-----------------	----------------------------	--

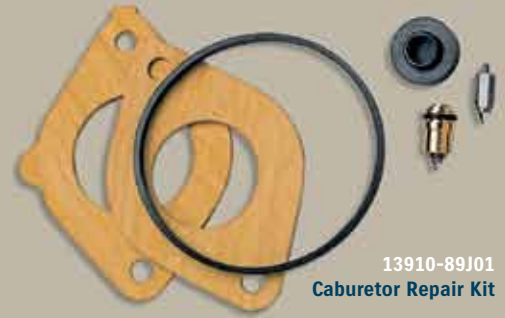

13910-89J01
Carburetor Repair Kit

55125-95500	DF40/50	'99 - '10
	DF40A/50A/60A	



55125-98J10	DF250S	'08 - Current
-------------	--------	---------------



55125-93L00-0EP	DF250AP/300AP	'13 - Current
-----------------	---------------	---------------



55125-92J00	DF115/140Z	'08 - Current
-------------	------------	---------------



55125-96310	DF25/30	'00 - '10
	DF25 V-Twin	'06 - Current



55300-95500	DF9.9/15	'04 - '10
	DF40/50	'96 - '03
	DF40A/50A/60A	'99 - '10
		'10 - Current



55320-94900	DF60 thru 300	'01 - '10
-------------	---------------	-----------



55320-95311	DF25 /30	'00 - '07
	DF40/50	'99 - '08
	DF40A/50A/60A	'10 - Current
	DF60/70	'01 - '08
	DF150/175	'06 - Current
	DF200/225/250/300	'04 - Current



55321-90J01	DF60-140	'98 - '08
-------------	----------	-----------



55321-93900	DF9.9/15	'97 - '08
-------------	----------	-----------



Application Chart



DF4/6 '03 - Current

	Part Number	Notes
Side Mount Control Box	67200-91J01	
Remote Control Attaching Kit	67130-91J01	
Rectifier Set	32801-91J00	

	Part Number	Notes
Water Pump Repair Kit	17400-98661	'03 - '10
	17400-986L0	'11 - Current
Battery Charging Kit	32000-91J00	

	Part Number	Notes
Receptacle	39600-91J00	
Spark Plug	BPR6ES	09482-00299 '03 - '10
	CPR6EA-9	09482-00L04 '11 - Current

DF9.9A '10 - Current

	Part Number	Notes
Side Mount Control Box	67200-94J12	
Remote Control Attaching Kit	67130-99J00	
Water Pump Repair Kit	17400-99J00	

	Part Number	Notes
Electric Starter Set	31000-99J00	
Battery Charging Kit	32000-99J00	
Oil Filter	16510-05240	'10
	16510-45H10	'11 - Current

	Part Number	Notes
Drag Link	67701-99J00	
Propeller Hardware Kit	57630-99J00	
Spark Plug	CR6E	09482-00528

DF9.9/15 '96 - Current

	Part Number	Notes
Side Mount Control Box	67200-94J11	'05 - Current
Remote Control Attaching Kit	67130-94J11	'05 - Current
Remote Control Cables	99105-11002-0XX* 2 req'd	
Harness, Remote Control	36630-89E02***	'96 - '04
Main Harness	36620-94J01	'05 - Current
Water Pump Repair Kit	17400-93951	'96 - '06
	17400-94J10	'07 - Current
Steering Bracket Attachment	67720-93E00	
Tilt-Tube Attachment	41141-89E00	
Rectifier Set	32800-95D01	'96 - '04
	32800-94J11	'05 - Current

	Part Number	Notes
Rectifier Regulator	32801-94J00	'05 - Current
Battery Charging Kit	32000-94J00	'05 - Current
Optional Lighting Coil Set	32120-93E10	'96 - '04
Choke Solenoid	38610-93E00	'96 - '04
Bolts	01550-06167	2 req'd
Starter Motor Set	31101-95D20-0EP	'96 - '03
	31100-94J21	'05 - Current
Starter Switch Set	33800-93E10	'96 - '04
	33800-94J00	'05 - Current
Stator, 120W	32120-94J10	'06 - Current

	Part Number	Notes
Flywheel, Ring Gear Type	32102-93E20	'96 - '04
	32102-94J10	'05 - Current
Receptacle Set	39600-94J00	'05 - Current
Propeller Hardware Kit	57630-93900	
Drag Link Assembly	67701-93E12	'97 - Current
	67701-94JA0	9.9T Current
Spark Plug	DCPR6E	09482-00446 up to '04
	BKR6E	09482-00427 '04 - Current
	CPR6-EA-9	09482-00L04 '11 - Current
Oil Filter	DF9.9/15	16510-05240 '96 - Current
	DF9.9T/15	16510-45H10 '11 - Current

DF9.9B/15A/20A '12 - Current

	Part Number	Notes
Side Mount Control Box	67200-93J12	
Deluxe Single Binnacle Kit	67000-93J04	
Deluxe Dual Binnacle Kit	67000-93J14	
Deluxe Flush Mount Kit	67000-93J21	
Remote Control Attaching Kit	67130-95J02	
Remote Control Cables	99105-11002-0XX* 2 req'd	

	Part Number	Notes
Single Binnacle	67200-93J13	
Dual Binnacle	67200-93J23	
Flush Mount	67200-93J32	
Wire Harness 16'	36620-93J52	
Wire Harness 21'	36620-93J02	
Wire Harness 26'	36620-93J62	
Ignition Sw. Panel Assy.	37100-96J00	

	Part Number	Notes
Ing. Sw. Emg. Stop/Buzzer	37100-96J23	
Warning Buzzer	38500-92X50	
Emergency Stop Assy.	38803-93J03	
Water Pump Repair Kit	17400-94J01	
Drag Link Kit	67700-95J00	
Propeller Hardware Kit	57630-93900	
Spark Plug	09482-00446	DCPR6E

DF25A/30A '06 - Current

	Part Number	Notes
Side Mount Control Box	67200-94J11	
Deluxe Single Binnacle Kit	67000-93J04	
Deluxe Dual Binnacle Kit	67000-93J14	
Deluxe Flush Mount Kit	67000-93J21	
Remote Control Attaching Kit	67130-95J02	
Remote Control Cables	99105-11002-0XX* 2 req'd	

	Part Number	Notes
Single Binnacle	67200-93J13	
Dual Binnacle	67200-93J23	
Flush Mount	67200-93J32	
Wire Harness 16'	36620-93J52	
Wire Harness 21'	36620-93J02	
Wire Harness 26'	36620-93J62	
Ignition Sw. Panel Assy.	37100-96J00	

	Part Number	Notes
Ing. Sw. Emg. Stop/Buzzer	37100-96J23	
Warning Buzzer	38500-92X50	
Emergency Stop Assy.	38803-93J03	
Water Pump Repair Kit	17400-95J02	
Drag Link Kit	67700-95J00	
Propeller Hardware Kit	57630-96300	
Spark Plug	09482-00427	BKR6E

DF40A/50A/50AV/60A/60AV '10 - Current

	Part Number	Notes
Side Mount Control Box	67200-93J06**	
Deluxe Single Binnacle Kit	67000-93J04	
Deluxe Dual Binnacle Kit	67000-93J14	
Deluxe Flush Mount Kit	67000-93J21	
Remote Control Cables	99105-11002-0XX* 2 req'd	
Single Binnacle	67200-93J13	
Dual Binnacle	67200-93J23	
Flush Mount	67200-93J32	
Wire Harness 16'	36620-93J52	

	Part Number	Notes
Wire Harness 21'	36620-93J02	
Wire Harness 26'	36620-93J62	
Power Trim/Tilt Sw.	37805-93J00	
Ignition Sw. Panel Assy.	37100-96J00	
Dual Ign. Sw. Panel Assy	37100-96J10	
Ing. Sw. Emg. Stop/Buzzer	37100-96J23	
Warning Buzzer	38500-92X50	
Emergency Stop Assy.	37803-93J03	
Dual Engine Tie Bar	99105-10006	

	Part Number	Notes
Steering Tensioner	43770-99E00	
Water Pump Repair Kit	17400-88L00	
Tiller Handle Kit	63002-88L06-0EP	
Tiller Handle Kit with Tach	63002-88L20-0EP	DF40A/50A
Tiller Handle Kit with Tach	63002-88L10-0EP	DF60A
Drag Link Kit	67701-87J11	
Propeller Hardware Kit	57630-94300	
Propeller Hardware Kit	57630-90J00	DF50AV/60AV
Spark Plug	09482-00446	DCPR6E

SPECIFIC APPLICATION NOTES:

* Cable is available in one foot increments from 8 to 25 feet. (example: 008 = 8ft, 025 = 25ft)

** Must use with one of the following Main Harnesses:
16': 36620-93J50 21': 36620-93J00 25': 36620-93J60

*** Under-Hood Electric Start Harness.

Application Chart



DF70A/80A/90A '09 - Current

	Part Number	Notes
Side Mount Control Box	67200-93J06**	
Deluxe Single Binnacle Kit	67000-93J04	
Deluxe Dual Binnacle Kit	67000-93J14	
Deluxe Flush Mount Kit	67000-93J21	
Remote Control Cables	99105-11002-0XX* 2 req'd	
Single Binnacle	67200-93J13	
Dual Binnacle	67200-93J23	
Flush Mount	67200-93J32	

	Part Number	Notes
Wire Harness 16'	36620-93J52	
Wire Harness 21'	36620-93J02	
Wire Harness 26'	36620-93J62	
Power Trim/Tilt Sw.	37805-93J00	
Ignition Sw. Panel Assy.	37100-96J00	
Dual Ign. Sw. Panel Assy	37100-96J10	
Ing. Sw. Emg. Stop/Buzzer	37100-96J23	
Warning Buzzer	38500-92X50	

	Part Number	Notes
Emergency Stop Assy.	37803-93J03	
Dual Engine Tie Bar	99105-10006	
Water Pump Repair Kit	17400-87L01	
Tiller Handle Kit	63002-87L03-0EP '09 - Current	
Tiller Handle Kit with Tach	63002-87L10-0EP	
Drag Link Kit	67701-87L00	
Propeller Hardware Kit	57630-90J00	
Spark Plug	09482-00446	DCPR6E

DF90/115/115A/140/140A '01 - Current

	Part Number	Notes
Side Mount Control Box	67200-93J06**	
Deluxe Single Binnacle Kit	67000-93J04	
Deluxe Dual Binnacle Kit	67000-93J14	
Deluxe Flush Mount Kit	67000-93J21	
Remote Control Cables	99105-11002-0XX* 2 req'd	
Single Binnacle	67200-93J13	
Dual Binnacle	67200-93J23	
Flush Mount	67200-93J32	
Wire Harness 16'	36620-93J52	

	Part Number	Notes
Wire Harness 21'	36620-93J02	
Wire Harness 26'	36620-93J62	
Power Trim/Tilt Sw.	37805-93J00	
Ignition Sw. Panel Assy.	37100-96J00	
Dual Ign. Sw. Panel Assy	37100-96J10	
Ing. Sw. Emg. Stop/Buzzer	37100-96J23	
Warning Buzzer	38500-93J00	'01 - '04
	38500-92X50	'05 - Current
Emergency Stop Assy.	37803-93J03	

	Part Number	Notes
Dual Engine Tie Bar	99105-10006	
Water Pump Repair Kit	17400-90J20	'01 - '05
	17400-92J00	'06 - '08
DF100A/115/115A/140A	17400-92J21	'09 - Current
Tiller Handle Kit	63002-90J26-0EP	
Tiller Handle Kit with Tach	63002-90J30-0EP DF115A	
Drag Link Kit	67701-90J00	'01 - '10
Propeller Hardware Kit	57630-90J00	
Spark Plug	09482-00427	BKR6E

DF150/175 '06 - Current

	Part Number	Notes
Side Mount Control Box	67200-93J06**	
Deluxe Single Binnacle Kit	67000-93J04	
Deluxe Dual Binnacle Kit	67000-93J14	
Deluxe Flush Mount Kit	67000-93J21	
Remote Control Cables	99105-11002-0XX* 2 req'd	
Single Binnacle	67200-93J13	
Dual Binnacle	67200-93J23	

	Part Number	Notes
Flush Mount	67200-93J32	
Wire Harness 16'	36620-93J52	
Wire Harness 21'	36620-93J02	
Wire Harness 26'	36620-93J62	
Power Trim/Tilt Sw.	37805-93J00	
Ignition Sw. Panel Assy.	37100-96J00	
Dual Ign. Sw. Panel Assy	37100-96J13	

	Part Number	Notes
Ing. Sw. Emg. Stop/Buzzer	37100-96J23	
Warning Buzzer	38500-92X50	
Emergency Stop Assy.	37803-93J03	
Water Pump Repair Kit	17400-96J01	
Drag Link Kit	67701-96J00	
Propeller Hardware Kit	57630-92E00	
Spark Plug	09482-00427	BKR6E

DF200/225/250 '04 - Current

	Part Number	Notes
Side Mount Control Box	67200-93J06**	'04 - Current
Deluxe Single Binnacle Kit	67000-93J04	
Deluxe Dual Binnacle Kit	67000-93J14	
Deluxe Flush Mount Kit	67000-93J21	
Remote Control Cables	99105-11002-0XX* 2 req'd	
Single Binnacle	67200-93J13	
Dual Binnacle	67200-93J23	'04 - Current

	Part Number	Notes
Flush Mount	67200-93J32	'04 - Current
Wire Harness 16'	36620-93J52	
Wire Harness 21'	36620-93J02	
Wire Harness 26'	36620-93J62	
Power Trim/Tilt Sw.	37805-93J00	
Ignition Sw. Panel Assy.	37100-96J00	
Dual Ign. Sw. Panel Assy	37100-96J13	

	Part Number	Notes
Ing. Sw. Emg. Stop/Buzzer	37100-96J23	
Warning Buzzer	38500-92X50	
Emergency Stop Assy.	37803-93J03	
Water Pump Repair Kit	17400-93J01	'04 - Current
Drag Link Kit	67700-93J00	'04 - Current
Propeller Hardware Kit	57630-92E00	'04 - Current
Spark Plug	09482-00427	BKR6E

DF250SS '08 - Current

	Part Number	Notes
Side Mount Control Box	67200-93J06**	
Deluxe Single Binnacle Kit	67000-93J04	
Deluxe Dual Binnacle Kit	67000-93J14	
Deluxe Flush Mount Kit	67000-93J21	
Remote Control Cables	99105-11002-0XX* 2 req'd	
Single Binnacle	67200-93J13	
Dual Binnacle	67200-93J23	

	Part Number	Notes
Flush Mount	67200-93J32	
Wire Harness 16'	36620-93J52	
Wire Harness 21'	36620-93J02	
Wire Harness 26'	36620-93J62	
Power Trim/Tilt Sw.	37805-93J00	
Ignition Sw. Panel Assy.	37100-96J00	
Dual Ign. Sw. Panel Assy	37100-96J13	

	Part Number	Notes
Ing. Sw. Emg. Stop/Buzzer	37100-96J23	
Warning Buzzer	38500-92X50	
Emergency Stop Assy.	37803-93J03	
Water Pump Repair Kit	17400-98J01	
Drag Link Kit	67700-93J00	
Propeller Hardware Kit	57630-92E00	
Gear Case Seal Kit	25700-98J00	
Spark Plug	09482-00427	BKR6E

SPECIFIC APPLICATION NOTES:

* Cable is available in one foot increments from 8 to 25 feet. (example: 008 = 8ft, 025 = 25ft)

** Must use with one of the following Main Harnesses:
16': 36620-93J50 21': 36620-93J00 25': 36620-93J60

*** Under-Hood Electric Start Harness.

Application Chart



DF150G/175G

	Part Number
Single Engine First Station Kit	67000-98J08
Single Engine Dual Station Kit	67000-98J18
Dual Engine First Station Kit	67000-98J28
Dual Engine Dual Station Kit	67000-98J38
Triple Engine First Station Kit	67000-98J48
Triple Engine Dual Station Kit	67000-98J58
Quad Engine First Station Kit	67000-98J70
Quad Engine Dual Station Kit	67000-98J80

	Part Number
Flush Mount Station Kit	67000-98J67
Remote Control Assembly, Single	67200-98J02
Remote Control Assembly, Multi	67200-98J13
Remote Control Assembly, Flush	67200-98J21
Panel Assembly, Main Switch	37100-98J03
Panel Assembly, Single	37100-98J11
Panel Assembly, Dual	37100-98J21
Panel Assembly, Triple	37100-98J31

	Part Number
Main Power Key Switch Assembly	37100-98J03
Panel Assembly, Emergency Stop	37803-93J03
Warning Buzzer	38500-92X50
Water Pump Repair Kit	17400-96J01
Gear Case Seal Kit	25700-93J00
Drag Link Kit	67701-96J00
Propeller Hardware Kit	57630-92E00
Spark Plug	BKR6E 09482-00427

DF250AP/300/300AP

	Part Number
Single Engine First Station Kit	67000-98J08
Single Engine Dual Station Kit	67000-98J18
Dual Engine First Station Kit	67000-98J28
Dual Engine Dual Station Kit	67000-98J38
Triple Engine First Station Kit	67000-98J48
Triple Engine Dual Station Kit	67000-98J58
Quad Engine First Station Kit	67000-98J70
Quad Engine Dual Station Kit	67000-98J80

	Part Number
Flush Mount Station Kit	67000-98J67
Remote Control Assembly, Single	67200-98J02
Remote Control Assembly, Multi	67200-98J13
Remote Control Assembly, Flush	67200-98J21
Panel Assembly, Main Switch	37100-98J03
Panel Assembly, Single	37100-98J11
Panel Assembly, Dual	37100-98J21
Panel Assembly, Triple	37100-98J31

	Part Number
Main Power Key Switch Assembly	37100-98J03
Panel Assembly, Emergency Stop	37803-93J03
Warning Buzzer Assembly	38500-92X50
Water Pump Repair Kit	250AP 17400-93J01 300/300AP 17400-98J01
Gear Case Seal Kit	25700-98J00
Drag Link Kit	67701-93J00
Propeller Nut Kit	57630-92E00
Spark Plug	BKR6E 09482-00427



Maintenance and Care



990C0-10W40-GAL
Marine 4-Cycle Engine Oil



990C0-10W40-QRT
Marine 4-Cycle Engine Oil



99950-06010
Fuel conditioner & Water Remover



99950-06025
Fuel Injection Cleaner



99105-50041
Hypoid Gear Oil

Recommended Oil Change Periods

1st 20 hours	Every 100 hours	Every 200 hours
Oil & Filter	Oil	Oil & Filters

Oil Change Necessities

09248-12007	Oil Drain Plug	All models
09168-12012	Drain Plug Gasket	All models



09248-12007
Oil Drain Plug



09168-12012
Drain Plug Gasket

Marine 4-Cycle Engine Oil

Premium synthetic blend 4-cycle engine oil is formulated to provide superior lubrication and protection for your four-stroke outboard engine. It also protects internal engine parts from rust and corrosion in harsh marine environments. See chart for recommended oil filter and capacities.

990C0-10W40-QRT	1 QT. Bottle	12/Case
990C0-10W40-GAL	1 GL Bottle	6/Case
990C0-10W40-DRM	55 Gallon Drum	

Dealers: Engine Oil must be ordered separately from all Parts and Accessories. See Suzuki Connect for instructions.

Oil Filters And Capacities

Models	Filter Part Number	Oil Capacity w/out Filter U/QT	Oil Capacity w/Filter U/QT
DF9.9/15 '96 - '10	16510-05240*	1.0/1.1	1.1/1.2
DF9.9T/9.9HT/15 '11~	16510-45H10	1.0/1.1	1.1/1.2
DF8A/9.9A	16510-05240	.8/.85	.9/.95
DF25/30	16510-87J00	3.0/3.2	3.2/3.4
DF25V-Twin	16510-87J00	1.5/1.6	1.8/1.9
DF40/50	16510-87J00	2.2/2.3	2.4/2.5
DF60/70	16510-87J00	4.5/4.8	4.8/5.1
DF40A/50A/60A	16510-87J00	2.7/3.0	2.9/3.2
DF70A/80A/90A '09-'10	16510-61A20-MHL	4.2/4.0	4.4/4.7
DF70A/80A/90A '11~	16510-61A31	4.2/4.0	4.4/4.7
DF90/115	16510-61A20-MHL	5.5/5.8	5.7/6.0
DF140	16510-82703	5.5/5.8	5.7/6.0
DF150/175	16510-96J00	8.0/8.5	8.5/9.0
DF200/225/250 - '07	16510-96J00	8.0/8.5	8.2/8.7
DF200/225/250/300	16510-96J00	8.0/8.5	8.2/8.7

*Also replace "O" Rings 09280-54001 & 09280-13004

Fuel Conditioner & Water Remover

Fuel Conditioner keeps stored fuel fresh for long periods of time.

99950-06010	12 Fluid oz. Bottle	12/Case
-------------	---------------------	---------

Fuel Injector Cleaner

Suzuki Fuel Injector Cleaner keeps injectors clean and corrosion-free for maximum power. Dissolves gum and varnish.

99950-06025	12 Fluid oz. Bottle	12/Case
-------------	---------------------	---------

Hypoid Gear Oil

Hypoid gear oil is formulated to Suzuki specifications. Available in two convenient sizes: 32 ounce and 5 gallon bottles. See chart for recommended gear oil capacities.

99105-50041	32 oz.	12/Case
99105-50046	5 Gallon	

Gear Oil Capacity

Model	Gear Case Oil Capacity (cc)	Gear Case Oil Capacity (oz)
DF4/6	190 cc.	6.4 oz.
DF9.9/15	175 cc.	5.9 oz.
DT9.9/15/15C	170 cc.	5.7 oz.
DF25/30	230 cc.	7.8 oz.
DF25V-Twin	420 cc.	14.2 oz.
DF40A/50A/60A/40/50	610 cc.	20.6 oz.
DF60/70	1050 cc.	35.5 oz.
DF70A/80A/90A	850 cc.	28.7 oz.
DF90/115/140	1050 cc.	35.5 oz.
DF150/175/200/225/250/250S	1100 cc.	37.2 oz.
DF300	1100 cc.	37.2 oz.
DT2 (Short Shaft)	70 cc.	2.4 oz.
DT2 (Long Shaft)	120 cc.	4.0 oz.
DT3.5	85 cc.	2.9 oz.
DT4	190 cc.	6.4 oz.
DT5/6/8	240 cc.	11.5 oz.
DT8C/9.9C/9.9CN	175 cc.	5.9 oz.
DT20/25/30/30C/35C	230 cc.	7.8 oz.
DT40	610 cc.	20.6 oz.
DT50/55/60/65	650 cc.	22.0 oz.
DT75/85	700 cc.	23.7 oz.
DT90/100	560 cc.	18.9 oz.
DT115/140	1100 cc.	37.2 oz.
DT150/175/200/225	1050 cc.	35.5 oz.

Spark Plugs

Models	Part Number	Spark Plug
DF2.5	09482-00406	CR6HSA
DF4/6 - '03 - '10	09482-00299	BPR6ES
DF4/6 - '11 ~	09482-00L04	CR6EEA-9
DF8A/9.9A	09482-00528	CR6E
DF9.9/15 - up to '04	09482-00446	DCPR6E
DF9.9/15 - '04-'10	09482-00427	BKR6E
DF9.9/15 - '11 ~	09482-00L04	CPR6EA-9
DF25/30	09482-00446	DCPR6E
DF25 V-TWIN	09482-00427	BKR6E
DF40/50	09482-00446	DCPR6E
DF60/70	09482-00299	BPR6ES
DF40A/50A/60A	09482-00446	DCPR6E
DF70A/80A/90A	09482-00446	DCPR6E
DF90/115/140/100A	09482-00427	BKR6E
DF150/175	09482-00427	BKR6E
DF200/225/250	09482-00427	BKR6E
DF250SS	09482-00427	BKR6E
DF300	09482-00427	BKR6E



09482-00446
Spark Plug

Maintenance and Care



990A0-03006
Spray Cleaner & Polish - 5 fl. oz.



990A0-03005
Spray Cleaner & Polish - 14 fl. oz.



99950-06030
Spray Carburetor and Choke Cleaner



990B0-01015
Suzuki Performance Low VOC Brake Cleaner



99950-06035
Wheel Cleaner

99105-65006
Engine cover - DF150/175

99105-65004
Engine cover - DF115/140

99105-65008
Engine cover - DF300





990C0-40000
Flush Kit



55181-95200
Flush Hose Attachment



99104-31140
Suzuki Bond 1207B



93691-80030
Silicone Seal



99000-25350
Water Resistant Grease



99000-32030
Thread Lock - 1303



99000-32130
Thread Lock - 1360



99000-32050
Thread Lock - 1342

99000-32020
Thread Lock - 1333B

Spray Cleaner & Polish

Suzuki Spray Cleaner & Polish is the ultimate “detailer in a can”. It cleans dirt, road contaminants, bugs, water spots and shipping preservatives without water, leaving a “showroom shine” that helps to protect against UV damage, ozone and dirt accumulation.

990A0-03006	5 Fluid oz.	12/Case
990A0-03005	14 Fluid oz.	12/Case

Spray Carburetor And Choke Cleaner

Suzuki Carburetor and choke cleaner quickly dissolves gum, varnish, and carbon deposits for fast and effective cleaning of carburetors without leaving a filmy residue.

99950-06030	12.5 oz. Can	12/Case
-------------	--------------	---------

Suzuki Performance Low VOC Brake Cleaner

Blasts away brake fluid, dirt and contaminants quickly and easily with no residue. Helps stop annoying brake squeal and chatter. Cleans disc and drum assemblies, including springs, rotors and pads..

990B0-01015	184 oz. Can	12/Case
-------------	-------------	---------

Wheel Cleaner

Spray Suzuki Wheel Cleaner on cold wheels, then spray off with strong stream of water for fantastic-looking wheels.

99950-06035	32 Fluid oz.	6/Case
-------------	--------------	--------

Engine Covers

Custom fit Engine Covers feature Sunbrella® UV resistant, water repellent fabric and silk screened Four Stroke graphics.

99105-65003	DF90/115	99105-65001	DF40/50
99105-65002	DF60/70	99105-65004	DF115/140
99105-65006	DF150/175	99105-65005	DF200/225/250
99105-65008	DF300		

Flush Kit And Flush Hose Attachment

See Owners manual or service manual on how to use the flush attachments.

990C0-40000	DF8A/9A thru DF300
55181-95200	All 2 Stroke Models DF4 thru DF15 4 Stroke Models

Suzuki Bond 1207B

1207B is used for sealing crankcases due to its outstanding resistance to heat and oil.

99104-31140	3.5 oz. Tube
-------------	--------------

Silicone Seal

A clear adhesive sealer with a silicone base.

93691-80030	3.5 oz. Tube
-------------	--------------

Water Resistant Grease

Use on oil seal lips, links and joints of the engine that are below the waterline.

99000-25350	8.8 oz. Tube
-------------	--------------

Thread Locks

Prevents nuts and bolts from vibrating loose. Made with the same compounds used to assemble Suzuki Products at the factory. Four strengths for different applications. Easy to use and store in individual 10cc containers with different colors for quick identification.

99000-32020	1333B Medium Strength Bearing and Stud Lock
99000-32030	1303 High Strength Retaining Type
99000-32050	1342 Low Strength Frequent Repair
99000-32130	1360 Medium Strength High Temperature Type

Marine Style



990A0-13007-___
Suzuki Sport 1/4 Zip Pullover Jacket



990A0-18074-___
Suzuki Texture Performance Polo



990A0-18073-___
Suzuki Color Block Wicking Polo



990A0-17107
3D Red "S" Gradation Cap



990A0-17108
3D Blue "S" Gradation Cap



990A0-17122
Suzuki "S" Navy Cap



990A0-17116
Suzuki Logo'd Bio Washed Cotton Navy Cap



990A0-18077-___
Suzuki Women's Wicking Polo



990A0-18076-___
Suzuki Women's Performance Polo

Suzuki Sport 1/4 Zip Pullover Jacket

6.5oz 98% polyester 2% spandex - moisture wicking - quarter-zip front - sonic weld media zip pocket.

990A0-13007-___ Light Blue SML - XXL

Suzuki Texture Performance Polo

4.7oz 100% polyester textured knit - moisture wicking; anti-microbial finish - no-curl, rib-knit collar.

990A0-18074-___ Blue MED - XXL

Suzuki Color Block Wicking Polo

4.7oz 100% polyester textured knit - moisture wicking; anti-microbial finish - no-curl, rib-knit collar.

990A0-18073-___ Char/Wht MED - XXL

3D Red "S" Gradation Cap

Flex Fit X-Cap with 3D Red "S" Logo.

990A0-17107 Red One Size Fits Most

3D Blue "S" Gradation Cap

Flex Fit X-Cap with 3D Blue "S" Logo.

990A0-17108 Blue One Size Fits Most

Suzuki "S" Navy Cap

Suzuki "S" bio washed cotton cap, low profile with contrast stitching, adjustable fabric strap closure.

990A0-17122 Navy Blue Adjustable

Suzuki Logo'd Bio Washed Cotton Navy Cap

BioWashed Cotton low profile cap - adjustable fabric strap closure.

990A0-17116 Navy Adjustable

Suzuki Women's Wicking Polo

55% Pima Cotton / 45% Polyester - 4.7oz plaited with wicking inside, pima cotton outside - open placket - contrast side panel.

990A0-18077-___ Blue/Navy SML - XLG

Suzuki Women's Performance Polo

5.0oz 100% polyester textured knit - moisture wicking; anti-microbial finish - tailored side panels.

990A0-18076-___ Light Blue SML - XLG

Custom Imprint Program





Custom Imprint Program

Suzuki Genuine Accessories has put together a new custom Imprint Program so you can have your club name, organization or race team monogrammed onto hats, pit shirts, soft shell jackets and even screen-printed on T-shirts!

With low minimum order quantities, it's never been easier to make sure your team looks as good as the Suzuki models you enjoy!

Quantity minimums are as follows:

- At least one piece of any item for just Suzuki embroidery
- At least 6 pieces of any style of pit shirt, polo or camp shirt for custom monogramming
- At least 12 hats for custom monogramming
- At least 12 tee shirts for custom screening

The vendor will work directly with the Suzuki dealer to discuss what you would like to have imprinted on your garments. Once approved, you should receive shipment in as little as 10-14 days.

An order form with the part numbers and pricing as well as an imprint detail form is available from any Suzuki dealer.

*Suzuki dealers should refer to Dealer Imprint Program bulletin on Suzuki Connect for additional details.



Promotional



99950-19317
String Pennant



99950-19375
Vinyl Logo Banner



99950-19369
Vinyl Stadium Banner



99950-19245-MED
Suzuki Logo Decal



99950-19255
"S" Logo Sheet



990A0-99067
Suzuki Bench Top Mat By Matrix Concepts



990A0-99068
Suzuki Floor Mat By Matrix Concepts



990A0-99077
Suzuki Shelter



990A0-19100
Suzuki Key Fob



990A0-99017
Suzuki Stadium Cup



99950-19371
Suzuki Merchandise Bag - Paper



99950-19372
Suzuki Merchandise Bag - Plastic

Suzuki Banners And Pennants

Big, bright, bold Suzuki banners can help publicize your next open house or boating event.

99950-19317	String Pennant	50'
99950-19369	Vinyl Stadium Banner	4' x 20'
99950-19375	Vinyl Logo Banner	3' x 10'

Suzuki Logo Decals

Thermal die-cut vinyl Official Suzuki logo available in sizes from 4" to 20". Dealers order in packs of 5.

99950-19245-MED	Suzuki Logo	12"
99950-19245-LRG	Suzuki Logo	20"
99950-19255	"S" Logo Sheet	

Suzuki Floor Mat By Matrix Concepts

Chemical resistant PVC mats for your work bench and shop floor. Bench mat measures 18" x 20" and suited for use on your work bench or truck's tailgate - keeping parts clean and together. Floor mat measures 2 ft. x 4 ft. and provides a non-slip fatigue reducing surface in the shop and superior footing at the track. Both are easily rolled up for easy transport and storage in provided netted drawstring bag.

990A0-99068	Suzuki Floor Mat	2' X 4'
990A0-99067	Suzuki Bench Top Mat	18" X 20"

Suzuki Shelter

With a powder-coated 30mm steel frame, a PVC backed polyester top with sealed seams and silk-screened graphics, these canopies will look good and keep you in the shade for years. Includes zippered carrying case and stakes.

990A0-99077	Blue/White,	10'x10'
-------------	-------------	---------

Suzuki Key Fob

Made of flexible rubber, key fob features the Suzuki Corporate Logo. Dealers order in packs of three.

990A0-19100	Suzuki Key Fob
-------------	----------------

Suzuki Stadium Cup

22oz. plastic cup features Suzuki logo. Dealers order in packs of 5.

990A0-99017	Blue Cup with Suzuki Logo
-------------	---------------------------

Suzuki Merchandise Bags

Available in your choice of paper or plastic with Suzuki graphics in 500 piece packages.

99950-19371	Paper	12" H x 6" W
99950-19372	Plastic	13" H x 12" W



All information, illustrations, photographs and specifications contained in this brochure are based on the latest product information available at the time of publication. Due to improvements or other changes, there may be some discrepancies in this brochure. Suzuki reserves the right to make production changes at any time, without notice and without incurring any obligation to make the same or similar changes to accessories previously built or sold.

Note: Some items may require installation by an Authorized Suzuki Marine Dealer.



To locate the authorized Suzuki Dealer nearest you, log on to www.suzukimarine.com.

Suzuki Motor of America, Inc.
3251 East Imperial Highway Brea, California 92821

www.suzuki.com · www.suzukimarine.com

©2014 Suzuki Motor of America, Inc.
Printed in USA / Part Number 990C0-12014