



2015

**HARLEY-DAVIDSON®**

GENUINE MOTOR PARTS & ACCESSORIES







<b>STREET</b>	<b>08</b>	<b>SPORTSTER® Continued</b>	
Windshields	16	Fit Shop/Suspension	101
Handlebars	16	Foot Controls and Highway Pegs	103
Seating	17	Engine Guards and Soft Lower	106
Backrests and Racks	19	Gauges	109
Saddlebags and Luggage	20	Chassis Trim - Front End	110
Engine Trim	22	Chassis Trim - Brakes	113
Chassis Trim	23	Chassis Trim - Rear End	114
Hand and Foot Controls	24	Engine Trim	117
Wheels and Brakes	26	Chassis Trim - Bodywork	124
Engine Guards	27	Oil Coolers and Dipsticks	125
Screamin' Eagle® Performance	28		
Color Shop	29	<b>DYNA®</b>	<b>128</b>
		Windshields	142
<b>VRSC™</b>	<b>30</b>	Seating	147
Windshields	38	Backrests and Racks	156
Seating	39	Saddlebags and Luggage	165
Backrests and Racks	40	Tank and Chassis Trim	170
Saddlebags	42	Fit Shop/Suspension	174
Engine/Chassis Trim	43	Foot Controls and Highway Pegs	176
Chassis Trim - Front End	46	Engine Guards and Soft Lower	184
Chassis Trim - Rear End	48	Chassis Trim - Front End	186
Wheels, Sprockets and Brakes	49	Chassis Trim - Brakes	190
Hand and Foot Controls	51	Chassis Trim - Rear End	194
Engine Guards	55		
Lighting	56	<b>SOFTAIL®</b>	<b>200</b>
		Windshields	216
<b>SPORTSTER®</b>	<b>58</b>	Seating	225
Windshields	74	Backrests and Racks	239
Seating	78	Saddlebags and Luggage	250
Backrests and Racks	86	Tank and Console Trim	264
Saddlebags and Luggage	95	Fit Shop/Suspension	267

<b>SOFTAIL® Continued</b>	
Foot Controls	270
Engine Guards and Soft Lower	280
Highway Pegs	282
Chassis Trim - Front End	284
Chassis Trim - Rear End	295
Chassis Trim - Brakes	302
Chassis Trim - Bodywork	305
<b>TOURING &amp; TRIKE</b>	<b>308</b>
Windshields	336
Fairing Lower and Accessories	349
Seating	354
Backrests and Racks	373
Tour-Pak® Luggage	386
Tour-Pak Accessories	393
Saddlebags and Accessories	402
Luggage Accessories	415
Paint Protection	421
Charging Accessories	424
Fit Shop/Suspension	426
Foot Controls	430
Engine Guards and Jiffy Stands	440
Chassis Trim - Front End	442
Chassis Trim - Brakes	448
Chassis Trim - Bodywork	451
Chassis Trim - Fairing and Console	457
Chassis Trim - Rear End	471

<b>SCREAMIN' EAGLE®</b>	<b>476</b>
Air Cleaner Kits and Filters	479
Exhaust Systems	492
Street Tuner	510
XL and Twin Cam Stage Kits	511
Engine Components	516
Ignition	522
Clutch and Drivetrain	524
Crate Engines and Short Block	528
Long Block Program	531
<b>ENGINE TRIM</b>	<b>534</b>
Derby, Timer and Air Cleaner Trim	536
Air Cleaner Covers	548
Engine Trim - Big Twin	551
Oil Coolers	564
Oil Level Dipsticks	566
Cylinder Head Covers	568
Hardware Covers and Hardware	570
<b>CONTROLS</b>	<b>576</b>
Hand Grip and Foot Control Collections	578
Footpegs and Footboards	598
Highway Pegs and Footpeg Hardware	601
Mirrors	604
Hand Controls and Levers	610
Control Cables and Brake Lines	617
Handlebars	620
Handlebar Risers	638

<b>AUDIO &amp; GAUGES</b>	<b>642</b>
BOOM!™ Audio - Touring Bikes	644
BOOM!™ Audio - Cruiser Bikes	662
Antenna Systems	664
GPS Navigation	666
BOOM!™ Audio Accessories	669
Headsets	670
Auxiliary Power and Charging	672
Speedometers/Tachometers	674
Oil Temp/Pressure/Level	678
Fairing Mount Gauges	680
Gauge Trim	681
Clocks and Air Temp	683
Fuel Gauges, Caps and Medallions	684
<b>LIGHTING</b>	<b>690</b>
Headlamps and Auxiliary Lighting	692
Turn Signals	706
Tail and Brake Lamps	713
Decorative LED Lighting	718
Lighting Trim	724
Electrical Accessories	731
Horns and Horn Covers	732
License Mounts and Accessories	734
<b>WHEELS</b>	<b>738</b>
Custom Wheels	740
Custom Sprockets	765
Brake Rotors	767
Wheel Accessories	771

<b>LUGGAGE</b>	<b>772</b>
Touring Luggage and Accessories	774
Swingarm, Fork and Sissy Bar Bags	782
Windshield and Fairing Bags	784
Storage and Travel-Paks	787
Tie-Downs and Accessories	789
Flags	791
<b>COLOR SHOP</b>	<b>792</b>
Custom Seat Program	794
Custom Paint Sets	798
Color-Matched Accessories	802
Medallions and Decals	816
<b>GARAGE</b>	<b>820</b>
Surface Care Products	822
Motorcycle Covers	832
Garage Storage	837
Motorcycle Lifts and Tie-Downs	840
Security Locks and Systems	844
Tire Gauges and Air Pumps	851
Oil Change Accessories	852
Battery Chargers	854
Flashlights	857
Tools	858
Oil & Lubricants, Solvents and Sealants	860
Paints	867
Batteries	868
Spark Plugs	869
Air and Oil Filters	870
Brake Pads	873
Tires	874







GENUINE MOTOR PARTS & ACCESSORIES



2015

## MAKE A STATEMENT WITHOUT SAYING A WORD

Customizing your Harley-Davidson® motorcycle is a journey – one that gives you the freedom to shape your own identity. When you're ready to let your Harley® motorcycle tell the world exactly who you are, we'll help you find exactly the right way to say it:

With Harley-Davidson® Genuine Motor Parts & Accessories.



Ultra Limited Low shown in Deep Jade Pearl/Vivid Black. Freewheeler™ shown in Amber Whiskey.





## OUR PARTS, LIKE OUR NAME, STAND THE TEST OF TIME.

The name Harley-Davidson has been synonymous with quality and durability for more than 110 years. And everything we've learned since the first motorcycle rolled out of that tiny Milwaukee shed goes into every part we make. If it has our name on it, you can be sure it will live up to the legend born in Milwaukee in 1903. **By Harley, for Harleys.** Each of our Genuine Motor Parts & Accessories is precision-engineered to fit your bike exactly – with finishes that provide a perfect match. **Put to the Test.** No one subjects their parts and finishes to more demanding tests than we do, in the lab, on the test track, and on the road. **You Have our Word on It.** All parts and accessories are backed with a 12-month warranty. **We've Got Your Back.** Need directions on your journey of discovery? The factory-trained experts at your authorized Harley-Davidson® dealership are always available to answer your questions and help you build a bike as unique as you are.

**12**  
MONTH

GENUINE PARTS & ACCESSORIES ARE BACKED WITH A 12-MONTH WARRANTY

TESTED TO THE TOUGHEST H-D STANDARDS







#### BUILT TO TOUR

This ride takes you where you want to go—in style. This Fat Boy® motorcycle features a wind-cheating detachable windshield, plush Road Zeppelin® seat, supportive backrest, and saddlebags meant to haul your gear. And if the road turns dull, a twist of the throttle will keep you entertained.



#### BUILT TO PROWL

Ride through the shadows. With a slammed Profile® Low Front Suspension, frame hugging Brawler® seat and blacked-out front end and exhaust, this Fat Boy® bruiser hugs the road. And the sky-high apes\* and the Midnite Blaze custom paint add a two-fisted urban appeal.



#### EXPRESS YOUR TRUE SELF

Leave a bold, lasting impression when you trick out your ride with Harley-Davidson® Genuine Motor Parts & Accessories.

Bright and shiny. Dark and menacing. Colors that complement or contrast.

With thousands of Genuine Motor Parts & Accessories to choose from, you can turn any Harley® model into a one-of-a-kind custom creation. One that lets you be who you want to be, every time you get in the saddle.



#### BUILT TO DAZZLE

Dipped in chrome, this Fat Boy® motorcycle is ready to troll the hot spots. Armed with a broad-shouldered Beach Bar, Freight Train headlamp nacelle and Stinger wheels, this beauty will lead you there in style. And the Screamin' Eagle® mufflers will resonate with friends and rivals alike.



GENUINE MOTOR PARTS & ACCESSORIES



2015

# STREET

The street is where things happen, where life comes alive. The Harley-Davidson Street™ 750 and 500 motorcycles take you there, with liquid-cooled Harley-Davidson muscle; lean, agile handling, and a healthy dose of Dark Custom™ attitude.







STREET

500

XG500 | PRODUCTION COLOR: VIVID BLACK

Turn day into night on this Vivid Black Harley-Davidson Street™ 500 model. The black Daymaker™ LED headlamp lights the way and the cut-back Typhoon wheels with polished brake rotors keep things rolling. The Café solo seat keeps it simple, and the blacked-out Dark Custom™ trim, machined Edge Cut controls, and Buckshot exhaust shields continue the sinister look.

SEE WHAT'S ON THIS BIKE AT [H-D.COM/GALLERY](https://www.harley-davidson.com/gallery)





STREET

750

X6750 | PRODUCTION COLOR: MYSTERIOUS RED SUNGLO

The perfect play of black against red, this Harley-Davidson Street™ 750 model strikes a muscular pose. The black and aluminum Burst and Edge Cut accessories complement the bike's factory-accented cylinder fins, and the black detachable passenger backrest and luggage rack add practical support without overshadowing the Dark Custom™ attitude.



**STREET 750 TRANSFORMATION**

This Harley-Davidson Street™ 750 model starts out as the perfect combination of agile, liquid-cooled efficiency and flat-out urban fun – all with classic Dark Custom™ attitude.

**STREET SMARTS**

From there, it doesn't take much to turn the Harley-Davidson Street™ motorcycle into a one-of-a-kind custom masterpiece. This bike's classic Red & White Two-Tone custom paint, Edge Cut grips, Burst Collection foot controls and other bright accents add a traditional "Harley" touch to this Street 750

model's basic black approach. The Dark Custom™ medallions and the Screamin' Eagle® Edge Cut muffler end cap complement the 750's machined aluminum wheel and cylinder highlights, while the removable passenger backrest and luggage rack offer practical comfort and support for two.



**FIT**

One size can fit all. The nimble Harley-Davidson Street™ motorcycle is designed to accommodate a wide range of body types. Equipped with a Tallboy® seat or Reduced Reach seat or bar, the bike can be tailored to accommodate almost any rider.



**FUNCTION**

Comfort, convenience and conspicuousness: The basics of everyday riding. Adding a passenger backrest, luggage rack and soft luggage lets you pack for your commute or for a weekend away from the office. And the Daymaker™ LED headlamp makes sure others notice you.



**CARE AND MAINTENANCE**

While it's tempting to use standard "auto parts store" cleaning and service supplies, hold out for the real thing. Genuine Harley-Davidson® coolant, oils, filters, batteries and service parts are engineered for the unique surfaces and operating conditions your Harley® motorcycle will encounter.

**STYLE**

The Harley-Davidson Street™ motorcycle is the perfect blank canvas. Its Dark Custom™ roots let you establish the bike's personality from day one. Make a sinister statement in black, or dress it up in chrome. Determine a path that's right for you, and layer on the details that express your soul.

**PERFORMANCE**

The 750cc H-D® Revolution X™ liquid-cooled V-Twin engine delivers authentic Harley-Davidson® sounds every time you twist the throttle. And you can add a little extra punch with system-matched Screamin' Eagle® performance parts.



**CRAFTSMANSHIP**

We design and build the bikes, so we don't need to "reverse-engineer" parts to try and make them fit. Everything we make is rigorously tested to ensure it meets our high standards, and the finishes of our accessories match the bike's surfaces for a consistent appearance.

Parts list available at [h-d.com/gallery](http://h-d.com/gallery)



MAGNETIC TANK BAG & REDUCED REACH BAR



CHROME TYPHOON WHEELS & AXLE COVERS



CHROME ENGINE GUARD



DAYMAKER™ LED HEADLAMP



# 16 STREET™

## Windshields & Handlebars

### A. QUICK-RELEASE SUPER SPORT WINDSHIELD

Reduces the pounding of wind and shower of bugs but keeps the wind-in-the-hair feeling. Ideal for a cool morning ride, the sleek profile of the Super Sport Windshield hugs the front headlamp for a sporty look. The windshield mounts to the fork tubes with elegant die-cast lever locking clamps, so the windshield does not require any "leave-behind" docking hardware. You get quick on-and-off convenience and a clean, custom look. No tools are required and the kit includes everything needed to install the windshield.

**57400192** Light Smoke. **\$314.95**  
 Fits '15-later XG models. Installation requires removal of Original Equipment headlamp visor. Models equipped with a front mounted license plate require separate purchase of License Plate Bracket P/N 67900227. Windshield dimensions: Overall height 25.0"; width – 20.1".

### B. REDUCED REACH® HANDLEBAR\*

This handlebar is designed to bring the controls 2 inches closer to the rider for increased comfort. The position is helpful for shorter riders, but also places almost any size rider in an upright, relaxed riding profile. Available in show-quality chrome or satin-black finish to complement your bike's overall design sense.

#### Handlebar Dimensions:

Tip-to-Tip – 30.00"  
 Pull Back – 2.00"  
 Rise – 8.25"  
 Base Width – 8.25"  
 Knurl Width – 3.25"

Fits '15-later XG models. Installation requires separate purchase of Clutch Cable P/N 37200077.

**55800237** Chrome. **\$69.95**  
**55800224** Satin Black. **\$69.95**

#### Shown with:

#### CLUTCH CABLE – REDUCED REACH HANDLEBAR

Stock style cable to enable fitment of Reduced Reach handlebar on Harley-Davidson Street™ models.

**37200077** 55.41 in./1407.4mm. **\$44.95**  
 Fits '15-later XG models equipped with Reduced Reach Handlebar P/N 55800237 or 55800224.

### C. DAYMAKER™ LED HEADLAMPS

Cut through the night. Harley-Davidson® LED Lamps are brighter and whiter in color and provide a superior light pattern over standard incandescent lamps. Compared to the yellow light of a traditional halogen bulb, the LED lamp produces a "Daylight Color Impression" that appears more natural to the user. Headlamps feature horizontal "D-shaped" lenses that focus light into a pool in front of the motorcycle and separate high beam and low beam projector lenses that provide a focused beam of light ahead. Lamps are available in your choice of brilliant chrome or gloss black background to match your styling direction. The solid-state LEDs are designed for long life and the shock- and vibration-resistant lamp assembly mounts into existing light housings. Installation is quick and easy and the plug-in lamps connect to the factory headlamp wiring. The LED lamps are DOT and ECE approved.

Fits '15-later XG models.

**67700144** 5-3/4" Headlamp – Chrome. **\$399.95**  
**67700145** 5-3/4" Headlamp – Black. **\$399.95**

NEW



A. QUICK-RELEASE SUPER SPORT WINDSHIELD

NEW



B. REDUCED REACH HANDLEBAR – SATIN BLACK



C. DAYMAKER LED HEADLAMPS – CHROME



C. DAYMAKER LED HEADLAMPS – GLOSS BLACK

\*NOTE: Installation of some handlebars and risers may require a change in clutch and/or throttle cable and brake lines for some models. Handlebar height is regulated in many states. Check state or local laws before installation.

Notice: The prices appearing in this catalog are the manufacturer's suggested retail prices. Actual retail prices may vary.



**NEW**



**D. CAFÉ SOLO SEAT**

**D. CAFÉ SOLO SEAT**

There's something about the placement of the rider that makes the Cafe Solo Seat special. The one-up design and the high back pad hold the rider in place and provide a direct connection to the bike. You sit "in" the bike and your hands and feet reach naturally to the controls. The low-slung pad, narrow nose and the tapered tail enhance the bike's sporting profile and pays homage to the heritage of the iconic Café Racer style.

**52000168** **\$219.95**  
Fits '15-later XG models. Seat width 11.25".

**E. REDUCED REACH® SEAT**

Designed specifically for riders requiring a close to the bar riding position, this Reduced Reach® Seat is shaped to place the rider in a comfortable and confident relationship to the hand and foot controls. The seat moves the rider approximately 1.5" lower and 1.25" forward and the 1.25" slimmer front profile brings the legs closer together for an easier reach to the ground at a stop. The Reduced Reach Seat features a stepped profile that keeps the rider from sliding back during acceleration.

**52000123** **\$201.95**  
Fits '15-later XG models. Seat width 10.25"; passenger pillion width 6.75".

**F. TALLBOY® SEAT**

The correct riding position can help a tall rider sit comfortably on the bike, and avoid leg cramps and back strain during a long day in the saddle. For riders with a longer inseam, a Tallboy® Seat will put you on the road to fatigue-free riding. Designed to move the rider 1.25" up and 2.5" back from the stock seating position, a Tallboy Seat can eliminate the "knees-high" riding position and effectively places the body for a natural arm and leg reach to the controls.

**52000124** **\$201.95**  
Fits '15-later XG models. Seat width 10.5"; passenger pillion width 7.5".

**NEW**



**E. REDUCED REACH SEAT**

**NEW**



**F. TALLBOY SEAT**

**STREET**

*Notice: The prices appearing in this catalog are the manufacturer's suggested retail prices. Actual retail prices may vary.*



# 18 STREET™

## Seating

### A. ROAD ZEPPELIN® SEAT PAD

Experience ultimate comfort. Road Zeppelin® Seat Pads are equipped with a unique air bladder system that allows your weight to be distributed evenly across the entire seating surface, ensuring hours of comfort for both rider and passenger. The air bladder system is designed to remove pressure points and provide shock absorption to reduce vibration. The easy-to-reach integrated hand pump and air release valve permits quick and convenient adjustment. Pads feature an adjustable mounting strap and a non-skid surface to keep them in place.

Fits '15-later XG models.

<b>52000084</b>	Rider.	<b>\$129.95</b>
<b>52400060</b>	Passenger Pillion.	<b>\$129.95</b>

### B. CIRCULATOR SEAT AND BACKREST PADS

Keep comfortable on your next long ride. These breathable Circulator Seat Pads feature 3D construction that promotes air movement and reduces heat build-up where the rider's body touches the seat or backrest. Designed to keep the rider cool by reducing the perspiration build-up between you and the seating surface, the Circulator Pad can be installed and removed in seconds for easy cleaning.

Fits '15-later XG models.

<b>51074-10</b>	Rider.	<b>\$79.95</b>
<b>51078-10</b>	Passenger Pillion.	<b>\$69.95</b>

### C. RAIN COVERS\*

Featuring a handy storage sack, this black nylon, water-resistant cover packs easily and shelters your seat from the storm.

<b>51637-97</b>	Two-Up Seat.	<b>\$31.95</b>
-----------------	--------------	----------------

Fits '15-later XG models.

### D. QUICK-RELEASE SEAT HARDWARE KIT

These hardware kits allow the rider to remove one-piece Harley-Davidson® seats quickly and easily.

<b>51676-97A</b>		<b>\$19.95</b>
------------------	--	----------------

Fits '15-later XG models.



A. ROAD ZEPPELIN SEAT PAD (RIDER SHOWN)



B. CIRCULATOR SEAT PAD (RIDER SHOWN)



C. RAIN COVERS



D. QUICK-RELEASE SEAT HARDWARE KIT



**\*WARNING:** Do not use while riding; could result in death or serious injury.

Notice: The prices appearing in this catalog are the manufacturer's suggested retail prices. Actual retail prices may vary.





**NEW**

**E. H-D DETACHABLES TWO-UP LUGGAGE RACK**



**NEW**

**E. H-D® DETACHABLES™ TWO-UP LUGGAGE RACK\***

Smooth sweeping curves and a rich finish defines the look of this Luggage Rack. Available in chrome or gloss black, this sleek and functional rack is an elegant solution for carrying your luggage for a day at the office or for a ride across the country. The rack can be installed or removed from the Docking Hardware in seconds for a truly versatile ride and it can be equipped with the matching Backrest Upright and Pad for added passenger comfort.

Fits '15-later XG models. Requires separate purchase of Docking Hardware Kit P/N 52300285.

<b>50300071</b>	Chrome.	<b>\$199.95</b>
<b>50300091</b>	Gloss Black.	<b>\$199.95</b>

**F. SISSY BAR UPRIGHT**

A sissy bar upright and passenger backrest pad are the starting point to build a complete touring machine. The backrest pad provides long-range comfort and support and adds a feeling of control and confidence for the passenger. This unique upright attaches directly to the H-D® Detachables™ Two-Up Luggage Rack for a clean, custom look and the available Backrest Pad P/N 52300281 complements Original Equipment and accessory seats. Kit includes upright and mounting hardware.

Fits '15-later XG models equipped with H-D Detachables Luggage Rack P/N 50300071 or 50300091.

<b>52300283</b>	Chrome.	<b>\$79.95</b>
<b>52300307</b>	Gloss Black.	<b>\$79.95</b>

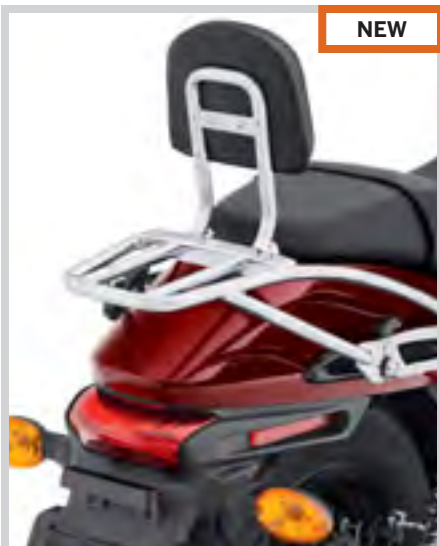

**NEW**

**F. SISSY BAR UPRIGHT (SHOWN WITH LUGGAGE RACK AND BACKREST PAD)**



**NEW**

**G. COMPACT PASSENGER BACKREST PAD**

This backrest pad sports French seams and a smooth, clean finish that looks great with any smooth surface seat.

**52300281** **\$49.95**

Fits '15-later XG models equipped with Sissy Bar Upright P/N 52300283 or 52300307.

**H. DOCKING HARDWARE**

Required for installation of detachable luggage rack on Harley-Davidson Street™ models.

**52300285** **\$39.95**

Fits '15-later XG models.



**NEW**

**G. COMPACT PASSENGER BACKREST PAD**



**NEW**

**H. DOCKING HARDWARE**



**\*WARNING:** Do not use this rack as a seat. Do not exceed the fender rack weight capacity. Using as seat or exceeding this capacity could cause handling problems which could result in loss of control and death or serious injury.

*Notice: The prices appearing in this catalog are the manufacturer's suggested retail prices. Actual retail prices may vary.*



## 20 STREET™

Luggage

### A. TANK BAG

Shaped to fit the contour of the fuel tank, this ballistic nylon UV- and weather resistant tank bag is your perfect traveling companion. The bag features a clear top pouch for at-a-glance viewing of maps and directions. The rigid body retains its shape – even when empty – and the full-length dual-zippered opening provides easy access. The interior features (2) zippered mesh pouches, (1) quick access nylon pouch and large center cavity for storage of larger items. The internal top pouch adds (3) additional storage slots and (3) pen/pencil holders. Headphone port lets you to “plug in” while keeping your device protected inside the bag. Tank Bag features integrated rain cover with reflective stripping. Integrated magnets and soft bottom keep the bag secure to tank while preventing scratches to paint. Quick-release clips allow the bag to be removed for easy access to the fuel filler and the comfortable carrying handle makes transportation a breeze.

**93300093**

**\$139.95**

Fits '15-later XG models.

### B. THROW-OVER SADDLEBAGS

Ballistic Nylon throw over saddlebags offer convenient storage and can be easily removed for transport. 3M™ reflective piping adds additional visibility and top mount zippers offer quick easy access to items. Center yoke allows for two up riding and can double as a shoulder strap when its time to carry the bags. Quick mount system allows rider to attach and detach saddlebags quickly. Kit includes saddlebag supports.

**90200906**

**\$359.95**

Fits '15-later XG models.

NEW



A. TANK BAG

NEW



B. THROW-OVER SADDLEBAGS

*Notice: The prices appearing in this catalog are the manufacturer's suggested retail prices. Actual retail prices may vary.*





C. DAY BAG



D. TAIL BAG



E. SISSY BAR BACKPACK



F. BOOM! AUDIO MUSIC PLAYER TANK POUCH

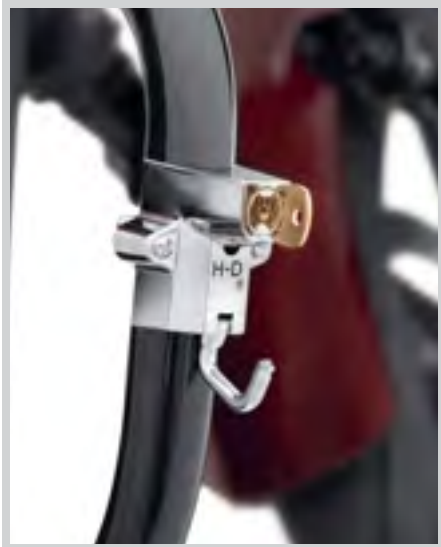

G. UNIVERSAL MOUNT HELMET LOCK

**C. DAY BAG**

The compact Day Bag is perfect for the daily work commute. The innovative spandex mounting pocket makes installation and removal a simple process. Just slip the smooth, low-profile band over the passenger backrest for a snug and secure fit and cinch the bag in place with the adjustable mounting straps. Bag and integrated rain cover feature 3M™ Scotchlite™ reflective piping and graphics for added visibility. Day Bag features 2 exterior pockets and 1 zippered mesh interior pocket. Day Bag Dimensions: 13.0" W x 10.0" D x 9.0" T. Luggage capacity: 900 cubic inches.

**93300017** **\$99.95**

Installation requires a sissy bar upright, backrest pad and luggage rack.

**D. TAIL BAG**

This Tail Bag is the perfect addition for your daily commute or a run to the sunset. The bag rests on the passenger pillion and is secured in position with adjustable quick-release straps. The surprisingly roomy bag features 2 exterior side pockets and a large top-opening for access to the interior. The UV-resistant ballistic nylon surface covers the built-in reinforced tub that helps the bag maintain its shape – even when empty. The bag features 3M Scotchlite reflective trim for added visibility, and an integrated rain cover for protection from the elements. Overnight Bag features 2 zippered exterior pockets and mesh interior pockets. Dimensions: 16.0" W x 16.0" D x 10.0" T. Luggage capacity: 1250 cubic inches.

**93300069A** **\$169.95**

Fits passenger pillion on most models.

**E. SISSY BAR BACKPACK**

This attractive backpack is shaped to provide convenient storage on your way to work. The heavy-duty hook-and-loop flaps secure the bag to the sissy bar for one-step installation. And when you get to work, this bag features traditional backpack straps that allow you to carry your bag in hands-free comfort. The bag features plenty of smart storage spaces with glove-friendly, ergonomically contoured zipper pulls. Backpack features 2 zippered exterior pockets, 2 exterior mesh water bottle pockets, personal music device pocket with headphone port, a padded laptop compartment and a large interior space. Bag and integrated rain cover feature 3M™ Scotchlite™ reflective piping and graphics for added visibility. Dimensions: 14.0" W x 13.0" D x 18.5" T. Luggage capacity: 1600 cubic inches.

**93300007** **\$149.95**

Installation requires a sissy bar upright, backrest pad and luggage rack (if not mounting luggage on passenger pillion).

**F. BOOM!™ AUDIO MUSIC PLAYER TANK POUCH**

The neoprene jacket offers hard-core protection for your portable music device, while the built-in magnets hold the pouch securely to the fuel tank. The clear play-through window permits touch-screen control and the anti-skid interior allows the pouch to accommodate players of various sizes. The clam-shell design makes inserting your player into the pouch quick and easy and the double zipper allows for headphone and output cables to exit the pouch at any point on top, bottom or one side of the pouch. Works well with many MP3 and other personal music players, but should not be used with hard-disk memory players. Window measurement: 2.25" W x 4.0" H.

**76000193** **\$44.95**

Fits models with steel fuel tanks or airbox covers.

**G. UNIVERSAL MOUNT HELMET LOCK**

To limit grab-and-run theft, just unlock the hinged clasp, hang your helmet by its strap and relock with the included key. Your helmet is held securely in place. In addition, hanging your helmet reduces the risk of impact damage if the helmet slipped off the seat or the handlebar. Designed to be installed to .875" to 1.25" diameter tubing engine guards, saddle-bag guards and frame tubes, the Helmet Lock is secured to the bike with tamper-proof hardware that cannot be easily removed. Note: Do not use lock when vehicle is in motion. Helmet Lock should only be used when motorcycle is parked and locked. Duplicate keys are not available.

**45732-86** **\$27.95**

Fits all models. All VRSC™, '15-later XG and '04-later XL and XR models require installation of engine guard.



## 22 STREET™

Engine Trim

### A. DARK CUSTOM™ LOGO COLLECTION

Make a bold statement with these easy to install, black anodized and machined billet medallions that match the Dark Custom black #1 skull collection.

**61300227** Air Cleaner Trim. **\$74.95**  
Fits '15-later XG models with Original Equipment air cleaner cover.

**25600033** Right Side Medallion. **\$64.95**  
Fits '15-later XG models.

**25700307** Left Side Medallion. **\$64.95**  
Fits '15-later XG models.

### B. COOLANT HOSE COVER KIT

Add a finishing touch to the left side profile of the Harley-Davidson Street™ motorcycle. This easy to install one-piece cover dresses the bike and protects the coolant hoses below the coil cover.

Fits '15-later XG models.

**26900107** Chrome. **\$64.95**

**26900108** Gloss Black. **\$64.95**



A. DARK CUSTOM LOGO COLLECTION – AIR CLEANER TRIM



A. DARK CUSTOM LOGO COLLECTION – RIGHT SIDE MEDALLION



A. DARK CUSTOM LOGO COLLECTION – LEFT SIDE MEDALLION



B. COOLANT HOSE COVER KIT – CHROME



B. COOLANT HOSE COVER KIT – GLOSS BLACK

*Notice: The prices appearing in this catalog are the manufacturer's suggested retail prices. Actual retail prices may vary.*





**NEW**

**C. FORK TUBE AND STEERING STEM COVER KIT – CHROME**



**NEW**

**C. FORK TUBE AND STEERING STEM COVER KIT – GLOSS BLACK**

**C. FORK TUBE AND STEERING STEM COVER KIT**

Highlighted with an embossed Bar & Shield logo, these smooth covers enhance the clean look of the upper triple tree. Easy to install kit includes two press-in fork tube covers and a moon-shape steering stem cover.

Fits '15-later XG models.

<b>45800053</b>	Chrome.	<b>\$54.95</b>
<b>45800056</b>	Gloss Black.	<b>\$54.95</b>

**D. SWINGARM PIVOT BOLT COVERS**

Conceal the swingarm pivot bolt in classic style. These easy to install gloss black covers hide the Original Equipment hardware and add a clean custom touch to the bike's profile. Complete kit includes left and right die-cast pivot bolt covers and necessary mounting hardware.

<b>61400269</b>	Gloss Black.	<b>\$31.95</b>
-----------------	--------------	----------------

Fits '15-later XG models.



**NEW**

**C. FORK TUBE AND STEERING STEM COVER KITS**



**NEW**

**D. SWINGARM PIVOT BOLT COVERS**

**E. FRONT AXLE NUT COVERS**

Cover the front axle in style. These smooth custom, die-cast Axle Nut Covers look great and add the finishing touch to complete a custom front end. These Axle Cover Kits are easy to install and include all necessary mounting hardware. Sold in pairs.

Fits '15-later XG models.

<b>43000026</b>	Black.	<b>\$27.95</b>
<b>44117-07A</b>	Chrome.	<b>\$27.95</b>

**F. REAR AXLE NUT COVERS**

Cover the rear axle in style. These smooth Axle Nut Covers look great and add the finishing touch to complete the custom look. These easy to install Axle Cover Kits include all necessary mounting hardware. Sold in pairs.

Fits '15-later XG models.

<b>43000018</b>	Black.	<b>\$29.95</b>
<b>43000022</b>	Chrome.	<b>\$29.95</b>



**NEW**

**E. FRONT AXLE NUT COVERS – GLOSS BLACK**



**E. FRONT AXLE NUT COVERS – CHROME**



**NEW**

**F. REAR AXLE NUT COVERS – GLOSS BLACK**



**NEW**

**F. REAR AXLE NUT COVERS – CHROME**

*Notice: The prices appearing in this catalog are the manufacturer's suggested retail prices. Actual retail prices may vary.*



# 24 STREET™

## Hand & Foot Controls

### A. EDGE CUT COLLECTION CONTROLS

Live your life on the edge. The Edge Cut Collection features a crisp anodized finish that is machined to expose the highlights of raw aluminum. The contrasting cut back look makes a powerful visual statement and works great with both traditional and contemporary customizing styles.

Fits '15-later XG models.

<b>56100083</b>	Hand Grips.	<b>\$84.95</b>
<b>49312-10</b>	Footpegs.	<b>\$84.95</b>
<b>34671-10</b>	Shifter Peg.	<b>\$29.95</b>
<b>42847-10</b>	Brake Pedal Pad.	<b>\$44.95</b>



A. EDGE CUT COLLECTION CONTROLS – HAND GRIPS

### B. DIAMOND BLACK COLLECTION CONTROLS

Shroud your bike in mystery. This collection features distinctive knurled surfaces that expose the raw billet aluminum for a dramatic contrast. The satin black finish will complement both high-gloss and “denim” paint colors and the narrow bands and the knurled surfaces provide a positive grip.

Fits '15-later XG models.

<b>50911-08A</b>	Footpegs.	<b>\$84.95</b>
<b>34690-08</b>	Shifter Peg.	<b>\$29.95</b>
<b>41850-08</b>	Brake Pedal Pad.	<b>\$44.95</b>



A. EDGE CUT COLLECTION CONTROLS – FOOT CONTROLS

### C. NARROW BAND BILLET COLLECTION CONTROLS

A raw look wrapped in class. This collection features a deep knurled surface for a positive grip and slim black rubber stripes over the chrome finish for stylish contrast. The mirror-chrome finish over the knurled surface scatters light to grab the attention of fellow riders.

Fits '15-later XG models.

<b>50978-99A</b>	Footpegs.	<b>\$84.95</b>
<b>49254-99</b>	Shifter Peg.	<b>\$29.95</b>
<b>42629-00</b>	Brake Pedal Pad.	<b>\$44.95</b>



B. DIAMOND BLACK COLLECTION CONTROLS



C. NARROW BAND BILLET COLLECTION CONTROLS

*Notice: The prices appearing in this catalog are the manufacturer's suggested retail prices. Actual retail prices may vary.*



**D. SILENCER COLLECTION CONTROLS****D. SILENCER COLLECTION CONTROLS**

Make your own noise. Unique electroless nickel plating provides this collection with a warm, burnished finish that looks like you've been twisting this throttle for years. The precision drilled surfaces bite against the sole of your boot for positive grip and provide the gun barrel look.

Fits '15-later XG models.

<b>50056-10</b>	Footpegs.	<b>\$79.95</b>
<b>35286-10</b>	Shifter Peg.	<b>\$19.95</b>
<b>48990-10</b>	Brake Pedal Pad.	<b>\$44.95</b>

**E. BURST COLLECTION CONTROLS**

Split with tradition. The Burst Collection takes your ride in a new hard-edged direction. A rich mixture of tuxedo black, satin aluminum and textured rubber, each component in this complete collection seamlessly ties the look together. The Burst Collection components create an impact all by themselves, but can also be combined with edge cut and other black accessories to complete the look.

Fits '15-later XG models.

<b>33600059</b>	Footpegs – Round.	<b>\$109.95</b>
<b>33600032</b>	Shifter Peg.	<b>\$29.95</b>
<b>50600140</b>	Brake Pedal Pad.	<b>\$49.95</b>

**NEW****NEW****E. BURST COLLECTION CONTROLS****F. BUCKSHOT MIRRORS\***

The deep grooved and perforated stem of this custom mirror complements Original Equipment and accessory foot and hand controls. The tapered mirror and stem are black-coated for a deep luster.

<b>92416-08</b>	Satin Black.	<b>\$219.95</b>
-----------------	--------------	-----------------

Fits '15-later XG models.

**G. TRIBAL COLLECTION MIRRORS\***

Billet-style mirror features a tapered shape that provides excellent rearward visibility. The deeply grooved stem and the swept-back design hug the contour of the handlebar and the tribal flames add an element of ancient mystery.

<b>92398-09</b>	Gloss Black.	<b>\$129.95</b>
-----------------	--------------	-----------------

Fits '15-later XG models.

**H. EDGE CUT MIRRORS\***

The tapered stems are black-anodized for a rich finish and the slots are machined to expose the raw aluminum and form the final cut back look. The ideal complement to the Edge Cut Collection of foot and hand controls.

<b>92441-10</b>		<b>\$219.95</b>
-----------------	--	-----------------

Fits '15-later XG models.

**I. SATIN BLACK DOME MIRRORS\***

This special mirror features a smooth, dome-shaped billet head, unique single slot stem and a satin black mirror. It's a clean look that provides distinctive style.

<b>92423-08A</b>		<b>\$199.95</b>
------------------	--	-----------------

Fits '15-later XG models.

**F. BUCKSHOT MIRRORS****G. TRIBAL COLLECTION MIRRORS****H. EDGE CUT MIRRORS****I. SATIN BLACK DOME MIRRORS**

\*Harley-Davidson Motor Company cannot test and make specific fitment recommendations concerning every possible mirror and handlebar combination. Therefore, after installing new mirrors or handlebars, and before operating the motorcycle, check to ensure that the mirrors provide the operator a clear view to the rear.

Notice: The prices appearing in this catalog are the manufacturer's suggested retail prices. Actual retail prices may vary.



## 26 STREET™

Custom Wheels & Rotors

### A. TYPHOON CUSTOM WHEEL

An intense storm is brewing. Nine arching spokes spin outward from the hub and blend seamlessly with the rim to add forward motion, even while standing still. The flat profile spokes and carved webs add visual intensity and tailor your bike to fit the mood. Requires separate purchase of model-specific Wheel Installation Kit, Sprocket hardware and Brake Rotor hardware. See I-sheet for details.

Front – Fits '15-later XG models.

**43300351** 17" Front, Cut Back Black. **\$459.95**

**43300350** 17" Front, Mirror Chrome. **\$559.95**

Rear – Fits '15-later XG models.

**40900358** 15" Rear, Cut Back Black. **\$459.95**

**40900359** 15" Rear, Mirror Chrome. **\$559.95**

#### Also available:

#### WHEEL INSTALLATION KIT

Once you select your wheel style, select the Wheel Installation Kit designed specifically for your motorcycle. Kit includes the bearings and spacers required for installation.

**42400008** Front, 25mm Axle **\$79.95**

Fits '15-later XG models, '08-later XL models without ABS brakes and '13-later FXSB models without ABS brakes.

**41451-08C** Rear, 25mm Axle. **\$79.95**

Fits '15-later XG and '08-later Dyna® models without ABS brakes.

### B. POLISHED BRAKE ROTORS

A perfect complement to stock or custom wheels. Manufactured to Original Equipment specifications for exact fit, these rotors are meticulously polished to achieve a chrome-like appearance. Rotors are sold individually and include chrome installation hardware.

Fits '15-later XG models.

**41500096** Front, Left. **\$149.95**

**41500097** Rear, Right. **\$149.95**



NEW

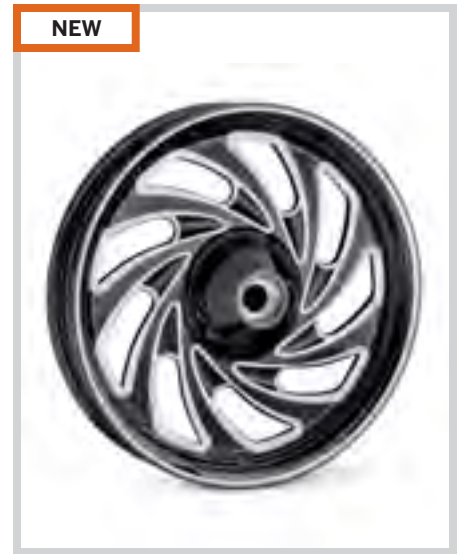

NEW

A. TYPHOON CUSTOM WHEEL – CUT BACK BLACK



NEW



NEW

A. TYPHOON CUSTOM WHEEL – MIRROR CHROME



NEW



NEW

B. POLISHED BRAKE ROTORS

Notice: The prices appearing in this catalog are the manufacturer's suggested retail prices. Actual retail prices may vary.



NEW



C. ENGINE GUARD – CHROME

**C. ENGINE GUARD\***

The unique soft curve shape adds style to function. The two-piece Engine Guard is designed to complement the lines of the Harley-Davidson Street™ motorcycle and the choice of finishes adds the perfect custom touch. Add your choice of Engine Guard Mounted Highway Pegs (sold separately) to change your foot position on a long ride.

Fits '15-later XG models.

<b>49000015</b>	Chrome.	<b>\$209.95</b>
<b>49000047</b>	Gloss Black.	<b>\$209.95</b>

**D. CENTER STAND**

Lifting your bike upright and off the side stand is ideal for cleaning and servicing and reduces the space required for parking – handy where space is at a premium in a crowded garage, a small parking spot or at a ride-in bike show. The robust gloss black painted center stand attaches directly to the frame and does not reduce the lean angle. Kit includes gloss black center stand, mounting brackets and all necessary installation hardware.

<b>92900014</b>		<b>\$199.95</b>
-----------------	--	-----------------

Fits '15-later XG models.

NEW



C. ENGINE GUARD – GLOSS BLACK

NEW



D. CENTER STAND



**\*WARNING:** These guards may provide limited leg and cosmetic vehicle protection under unique circumstances (fall over while stopped, very low speed slide). They are not made nor intended to provide protection from bodily injury in a collision with another vehicle or any other object.

Notice: The prices appearing in this catalog are the manufacturer's suggested retail prices. Actual retail prices may vary.



# 28 STREET™

Screamin' Eagle® Performance

## A. SCREAMIN' EAGLE® PERFORMANCE AIR CLEANER KIT

This kit provides a freer breathing capability to pump-up the power of your EFI-equipped motorcycle. Air Cleaner features a washable high-flow, oiled cotton media element. Kit includes a high-flow air filter element, Screamin' Eagle® air cleaner medallion and all required hardware.

**29400197** **\$79.95**  
Fits '15-later XG models.

Also available:

### SCREAMIN' EAGLE AIR CLEANER MEDALLION

Dress your air cleaner in style. Easy-to-install medallion features brilliant Screamin' Eagle script and Harley-Davidson lettering set against a rich black background. Self-adhesive backing for easy installation.

**61300364** **\$19.95**  
Fits '15-later XG models.

## B. SCREAMIN' EAGLE BUCKSHOT EXHAUST SHIELD KIT

These custom exhaust shields feature a perforated "Buckshot" design to expose the head pipe for a raw rebellious look. These exhaust shields are a perfect match for Original Equipment or Screamin' Eagle muffler and complement the blacked out Harley-Davidson Street™ model. Manufactured to Original Equipment standards for exacting fit, the easy-to-install kit includes front and rear head pipe shields.

**65400167** Jet Black. **\$149.95**  
Fits '15-later XG models.

## C. MUFFLER END CAP – EDGE CUT

This Edge Cut End Cap kit allows you to personalize your Original Equipment mufflers. These easy-to-install caps are dressed with the same black-anodized finish as the Edge Cut Collection for a consistent look front to back and feature machined aluminum accents for a modern touch.

**65100056** **\$89.95**  
Fits '15-later XG models with Original Equipment muffler.



A. SCREAMIN' EAGLE PERFORMANCE AIR CLEANER KIT



B. SCREAMIN' EAGLE BUCKSHOT EXHAUST SHIELD KIT



C. MUFFLER END CAP – EDGE CUT



These Screamin' Eagle products are 50-state street legal for sale and use on all vehicles, including those that are pollution-controlled. Complies with the requirements of 40 CFR Part 86, subparts E and F.

Notice: The prices appearing in this catalog are the manufacturer's suggested retail prices. Actual retail prices may vary.





**NEW**

**D. SCREAMIN' EAGLE NIGHTSTICK 2-INTO-1 SLIP-ON MUFFLER**

**STREET™ 29**

Screamin' Eagle® Performance & Paint

**D. SCREAMIN' EAGLE® NIGHTSTICK 2-INTO-1 SLIP-ON MUFFLER\***

Tuned by the factory for the ultimate combination of rich tone and legal sound levels, this slip-on muffler is the perfect match for your Harley-Davidson model. The high-flow design of the external diffusion discs produces plenty of low-end "guts" to get your bike away from the light and a fat torque curve that gets you quickly around slow-moving traffic. The multiple stainless steel diffusion discs and domed end cap deliver an aggressive raspy sound. Available in jet black finish, these long and lean pipes feature an embossed Screamin' Eagle® logo. Easy to install.

Fits '15-later XG models.

**64900220** Jet Black, Domestic. **\$349.95**

**E. COLOR SHOP LIMITED PAINT SET – CLASSIC TWO-TONE**

This classic two-tone design re-creates the historic Harley-Davidson style for the modern era. Available as a tank-only or 2-piece tank and rear fender set, the rich Candy Apple Red base and Alabaster White Pearl panel add a distinctive look to the Harley-Davidson Street™ model and complement the vivid black finish of the Original Equipment speed screen visor and fenders. Production limited to 100.

**92200099DYE** Two-Piece. **\$1,799.95**  
Fits '15-later XG models.

**61000157DYE** Tank Only. **\$1,199.95**  
Fits '15-later XG models.

**NEW**



**E. COLOR SHOP LIMITED PAINT – CLASSIC TWO-TONE**

**GO LIGHT** These Screamin' Eagle products are 50-state street legal for sale and use on all vehicles, including those that are pollution-controlled. Complies with the requirements of 40 CFR Part 86, subparts E and F.

\*NOTE: There is no warranty on exhaust pipes and mufflers with regard to any discoloration. Blueing is caused by tuning characteristics, cam timing, carburetor jetting, over-heating, etc. and is not caused by defective manufacturing.

Notice: The prices appearing in this catalog are the manufacturer's suggested retail prices. Actual retail prices may vary.

**STREET**



GENUINE MOTOR PARTS &amp; ACCESSORIES



2015

## V-ROD®

Few motorcycles have broken deeper ground than the Harley-Davidson® V-Rod® motorcycles, unleashed to the riding public in 2002. With drag-bike styling and street-smart, liquid-cooled performance, they blazed a trail for a whole new breed of rider.





VRSC™

## V-ROD MUSCLE®

VRSCF | PRODUCTION COLOR: MYSTERIOUS RED SUNGLO WITH FLAMES

This sleek and sexy V-Rod Muscle® motorcycle combines drag strip styling with a hot-rod mentality. Flamed Mysterious Red Sunglo paint, Black Ice wheels and rich red brake calipers add a noticeable high-performance touch, while the passenger backrest and luggage rack keep things practical.







VRSC™

## NIGHT ROD® SPECIAL

VRSCDX | PRODUCTION COLOR: DEEP JADE PEARL

Liquid-cooled Revolution® engine performance and attitude are within easy reach on this Night Rod® Special motorcycle with 5-Spoke Black Ice wheels and factory Deep Jade Pearl paint. The Reduced Reach seat brings the rider closer to the blacked-out handlebar and controls, freeing up extra room for your favorite passenger – or someone you just met.

SEE WHAT'S ON THIS BIKE AT [H-D.COM/GALLERY](https://www.harley-davidson.com/gallery)



V-ROD MUSCLE® TRANSFORMATION

POWER PLAYER

With loads of horsepower, 86 foot pounds of torque, and a blend of drag strip and boulevard style, this race-bred powerhouse is revved-up and ready to jump off the starting line.

See those bright red dual front brake calipers? That tells you this baby is born to run. Other clues? The monstrous 240mm rear tire wrapped around liquid-smooth Black Ice 5-spoke wheels, mirror polished brake rotors, and the black hot-rod flames covering the Mysterious Red Sunglo paint set.

Chrome engine covers, hand grips, hand controls, and foot controls catch just the right amount of light, and we've added a backrest pad and matching luggage rack—just to make sure you and your passenger enjoy all that style, power, and performance.



PASSENGER BACKREST & LUGGAGE RACK

BLACK ICE 5-SPOKE WHEELS

REAR AXLE COVER KIT



GET-A-GRIP™ HAND GRIPS

SCREAMIN' EAGLE® HIGH-FLO AIR FILTER

CHROME HAND CONTROLS

POLISHED BRAKE ROTORS

SWINGARM PIVOT COVERS

SLOTTED FOOT CONTROLS

RED FRONT BRAKE CALIPERS



FIT

Dressed in tactified rubber, Get-A-Grip™ hand grips provide a positive connection to the bike in wet or dry weather. If the stretch to those grips is a little too far, the V-Rod Muscle® motorcycle can be outfitted with a Reduced Reach handlebar to keep you firmly in control.



STYLE

Brawn is back. Five knife-edge spokes on the wheels define the distinctive hot-rod style, and their Black Ice finish is the perfect yin and yang to the satin aluminum finish on the engine cases, exhaust, and swingarm. Finish with a few touches of red for a little added heat.



FUNCTION

Comfort and convenience are the basics of everyday riding. Add a passenger backrest, luggage rack and set of soft luggage for your run to the office, or add an H-D® Detachables™ windshield, switch off your cell phone, and you are ready to leave the city streets behind.



PERFORMANCE

Out of the box, the Revolution® engine packs a punch and delivers a distinctive Harley-Davidson® sound at the twist the throttle. To let it breathe a little deeper, add a Screamin' Eagle® High-Flo air cleaner under the flamed airbox.



CARE AND MAINTENANCE

While it's tempting to use standard "auto parts store" cleaning and service supplies, hold out for the real thing. Genuine Harley-Davidson® coolant, oils, filters, batteries and service parts are engineered for the unique surfaces and operating conditions your Harley® motorcycle will encounter.



CRAFTSMANSHIP

We design and build the bikes, so we don't need to "reverse-engineer" parts to try and make them fit. Everything we make is rigorously tested to ensure it meets our high standards, and the finishes of our accessories match the bike's surfaces for a consistent appearance.



CAST PASSENGER BACKREST & LUGGAGE RACK

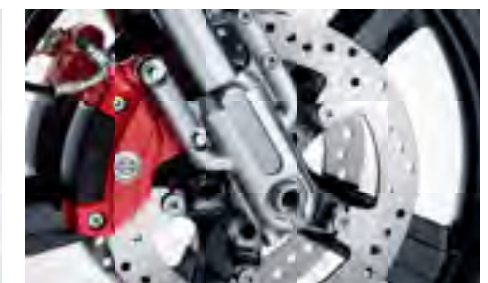

RED CALIPERS & POLISHED ROTORS



CHROME COOLANT HOSE COVER



GET-A-GRIP™ HAND GRIPS & CHROME HAND CONTROLS

Parts list available at [h-d.com/gallery](http://h-d.com/gallery)



# 38 VRSC™

## Windshields

### A. QUICK-RELEASE TOURING WINDSHIELDS

The Touring Windshield features an aerodynamic design shaped to provide hours of riding comfort. The additional center width directs airflow past the hand grips and deflects rain and road debris around the rider. The windshield mounts to the fork tubes with elegant die-cast lever-release clamps, so the windshield does not require any "leave-behind" docking hardware. You get quick on-and-off convenience and a clean, custom look. No tools are required. The tough, hard-coated polycarbonate windshield features a stylish horizontal brace with the Bar & Shield logo to accent the long, lean look of the V-Rod® model. Kit includes Turn Signal Relocation Kit.

**57177-05** 25" Clear. **\$459.95**  
Fits '02-'10 VRSCA, '04-'05 VRSCB and '07 VRSCX models. '05 VRSCB models require separate purchase of Headlamp Visor P/N 67750-88T and Visor Screw P/N 3383. Windshield dimensions: Overall height – 30.3"; width – 23.6".

**57211-05** 23" Clear. **\$429.95**  
Fits '02-'10 VRSCA, '04-'05 VRSCB and '07 VRSCX models. '05 VRSCB models require separate purchase of Headlamp Visor P/N 67750-88T and Visor Screw P/N 3383. Windshield dimensions: Overall height – 27.4"; width – 23.0".



A. QUICK-RELEASE TOURING WINDSHIELD – 25"



A. QUICK-RELEASE TOURING WINDSHIELD – 23"

### B. QUICK-RELEASE COMPACT MID-SPORT WINDSHIELD

Shaped to split the wind. This tough, hard-coated polycarbonate Mid-Sport Windshield wraps around the headlamp to offer the maximum wind protection available in a compact profile. The windshield mounts to the fork tubes with elegant die-cast lever-release clamps and to the handlebar with "plug-in" docking points, so the windshield does not require any "leave-behind" hardware. You get quick on-and-off convenience and a clean, custom look. No tools are required.

**57610-09** 18" Light Smoke. **\$349.95**  
Fits '09-later VRSCF models. Windshield dimensions: Overall height – 20"; width – 17.5".

**57400060** 18" Light Smoke. **\$359.95**  
Fits '12-later VRSCDX models. Windshield dimensions: Overall height – 24"; width – 17.5".



B. QUICK-RELEASE COMPACT MID-SPORT WINDSHIELD (VRSCF SHOWN)



B. QUICK-RELEASE COMPACT MID-SPORT WINDSHIELD ('12-LATER VRSCDX SHOWN)

### C. COMPACT MID-SPORT WINDSHIELD

Wind protection and style combined. This Mid-Sport Windshield wraps around the contour of the headlamp to offer the maximum wind protection available in a compact profile. The multi-point chrome mounting system attaches to the fork tubes and bars for a positive grip. Kit includes all necessary mounting hardware.

**57861-06** 12" Clear. **\$359.95**  
Fits '06-'08 VRSCD models. Windshield dimensions: Overall height – 21.3"; width – 17.9".

**57870-07** 12" Clear. **\$359.95**  
Fits '07-'11 VRSCDX models. Windshield dimensions: Overall height – 20.1"; width – 17.9".

**57213-06** 18" Clear. **\$359.95**  
Fits '06-'07 VRSCR and '07 VRSCX models. Windshield dimensions: Overall height – 21.3"; width – 18.2".



C. COMPACT MID-SPORT WINDSHIELD



D. SUPER SPORT WINDSHIELD

### D. SUPER SPORT WINDSHIELD

Super is an apt description for this do-it-all shield. Easily removable, this sporty windshield provides protection from the elements when you need it. The high-quality light smoke shield is hard-coated to resist scratching.

**57109-01** 21" Light Smoke. **\$339.95**  
Fits '02-'10 VRSCA models. Windshield dimensions: Overall height 21.5"; width 18.3".

Notice: The prices appearing in this catalog are the manufacturer's suggested retail prices. Actual retail prices may vary.





**E. SUNDOWNER RIDER SEAT –  
'12-LATER MODELS**



**E. SUNDOWNER RIDER SEAT –  
'07-'11 MODELS**

#### **E. SUNDOWNER™ RIDER SEAT**

The Sundowner™ Seat provides the ultimate in long-riding comfort. The deep bucket design places your body in the proper upright touring position and the generous padding keeps you comfortable as the miles add up. The contoured seating surface distributes your weight over a wider surface to reduce pressure points and the dished shape provides added rider back support. Available to fit many models, Sundowner Seats retain the Original Equipment pivot mounting for easy access to the fuel filler. Styled to match the Original Equipment passenger pillion, this rider touring seat features a contoured bucket that provides additional lower back support.

**52000048** **\$249.95**  
Fits '12-later VRSCDX models. Seat width 16.0".

**51778-07** **\$249.95**  
Fits '07-'11 VRSC™ models (except VRSCF and VRSCR).  
Requires use of Original Equipment passenger pillion or  
Touring Passenger Pillion P/N 51780-07. Seat width 13.0".

#### **F. SUNDOWNER RIDER SEAT AND PILLION**

Designed for the long haul, this touring seat and passenger pillion combination continues the comfort tradition of the Sundowner line. With both the rider and passenger in mind, this seat features a deep contoured rider position to provide added lower back support and a wide passenger pillion for superior passenger comfort.

**53432-02** **\$339.95**  
Fits '02-'06 VRSCA, VRSCB and VRSCD models. Also fits  
'05-'06 VRSCSE models. Requires use of Fender Base Plate  
or One-Piece Luggage Rack (sold separately). Seat width  
15.5"; pillion width 12.0".

#### **G. REDUCED REACH® RIDER SEAT**

Designed to position riders with a shorter inseam closer to the ground, Reduced Reach® Seats are shaped to place the rider in a comfortable and confident relationship to the hand and foot controls. The wide seating surface provides loads of support while riding and the narrow tapered nose brings your legs together for an easier reach to the ground at a stop. Reduced Reach Seats feature a stepped profile that provides back support and keeps the rider from sliding back during acceleration. Reduced Reach Seats retain the Original Equipment pivot mounting for easy access to the fuel filler. This low-profile Reduced Reach Rider Seat moves the rider forward for improved access to the hand and foot controls and minimizes the leg stretch to the ground at a stop or while parking the bike. The seat is styled to match the Original Equipment passenger pillion.

**52000049** **\$239.95**  
Fits '12-later VRSCDX models. Seat width 15.0".

**51781-07** **\$239.95**  
Fits '07-'11 VRSC models (except VRSCF and VRSCR).  
Requires use of Original Equipment passenger pillion or  
Touring Passenger Pillion P/N 51780-07. Seat width 13.0".



**F. SUNDOWNER RIDER SEAT AND PILLION – '02-'06 MODELS**



**G. REDUCED REACH RIDER SEAT –  
'12-LATER MODELS**

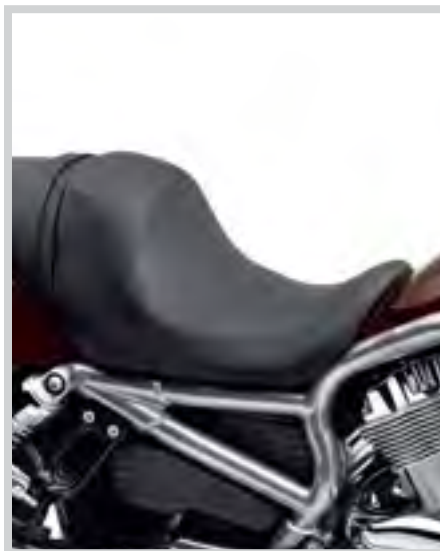

**G. REDUCED REACH RIDER SEAT –  
'02-'11 MODELS**

*Notice: The prices appearing in this catalog are the manufacturer's suggested retail prices. Actual retail prices may vary.*



# 40 VRSC™

## Seating & Backrests

### A. TOURING PASSENGER PILLION

Although the VRSC™ family of motorcycles is built for speed, it can also make a radical touring machine. This wide and contoured Passenger Pillion is shaped to deliver maximum passenger comfort for long hauls or around-town riding.

**51780-07** Smooth. **\$99.95**  
Fits '07-'11 VRSC™ models (except VRSCF and VRSCR). Requires separate purchase of model-specific Fender Base Plate. Pillion width 11.0".

**52023-01A** Textured. **\$99.95**  
Fits '02-'06 VRSCA, VRSCB and VRSCD models. Also fits '05 VRSCSE models. Requires use of Fender Base Plate or One-Piece Luggage Rack (sold separately). Pillion width 11.5".

**Shown with:**

**TOURING PASSENGER BACKREST PAD**

This wide Touring Backrest is shaped to provide added passenger comfort and support.

**51783-07** Smooth. **\$99.95**  
Fits '07-'11 VRSC (except VRSCF), '06-'07 VRSCR and '06 VRSCSE2 models equipped with Low Sissy Bar Upright P/N 51162-06 or 51313-07. Also fits Dyna® models equipped with Sissy Bar Upright P/N 52726-09.

**51569-01** Textured. **\$99.95**  
Fits '02-'06 VRSCA, VRSCB and VRSCD models equipped with Low Sissy Bar Upright P/N 51126-01A or 51145-04A.



**A. TOURING PASSENGER PILLION – SMOOTH (SHOWN WITH SMOOTH TOURING PASSENGER BACKREST PAD)**



**A. TOURING PASSENGER PILLION – TEXTURED (SHOWN WITH TEXTURED TOURING PASSENGER BACKREST PAD)**

### B. COMPACT PASSENGER BACKREST PADS

Styled to complement Original Equipment and accessory seats, these Compact Backrest Pads are engineered to fit specific sissy bar uprights.

Fits '02-'06 VRSCA, VRSCB and VRSCD models equipped with Low Sissy Bar Upright P/N 51126-01A or 51145-04A.

**51583-01** Smooth. **\$89.95**

**52748-02** Textured. **\$89.95**

Fits '07-'11 VRSC (except VRSCF), '06-'07 VRSCR and '06 VRSCSE2 models equipped with Sissy Bar Upright P/N 51162-06 or 51313-07, '06-later Dyna models equipped with Sissy Bar Upright P/N 52726-09. FXCW models equipped with Sissy Bar Upright P/N 52804-08.

**51782-07** Smooth. **\$79.95**



**B. COMPACT PASSENGER BACKREST PAD – (51782-07 SHOWN)**



**B. COMPACT PASSENGER BACKREST PADS**

### C. CAST UPRIGHT AND BACKREST PAD

Accent the low and lean look of the motorcycle with this highly styled cast passenger backrest. The unique cast upright with hidden hardware and the silver powder-coated finish blends with the bike to form a functional, yet stylish backrest. The backrest pad complements the Original Equipment seat. Kit includes upright, pad and mounting hardware.

**51600-09** **\$179.95**

Fits '09-later VRSCF models. Requires separate purchase of Upright Installation Kit P/N 51607-09 or Cast One-Piece Luggage Rack P/N 53315-09.

**52300016** **\$179.95**

Fits '12-later VRSCDX models. Requires separate purchase of Cast One-Piece Luggage Rack P/N 50300028.

**Also available:**

**UPRIGHT INSTALLATION KIT**

Required for installation of Cast Upright and Backrest Pad P/N 51600-09 when installed without Cast One-Piece Luggage Rack P/N 53315-09. Installation requires drilling holes in rear fender.

**51607-09** **\$29.95**

Fits '09-later VRSCF models.

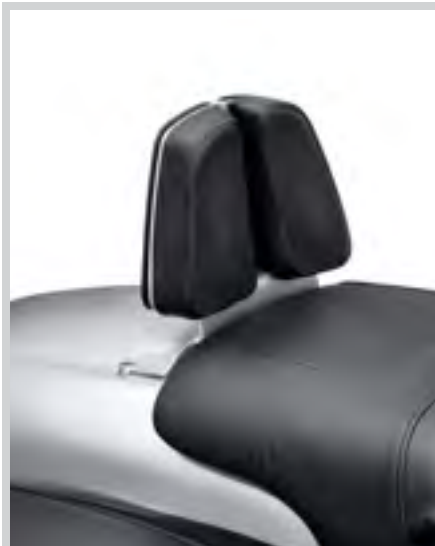

**C. CAST UPRIGHT AND BACKREST PAD (VRSCF SHOWN WITH UPRIGHT INSTALLATION KIT)**



**C. CAST UPRIGHT AND BACKREST PAD ('12-LATER VRSCDX SHOWN WITH CAST ONE-PIECE LUGGAGE RACK)**

*Notice: The prices appearing in this catalog are the manufacturer's suggested retail prices. Actual retail prices may vary.*





**D. CAST ONE-PIECE LUGGAGE RACK (VRSCF SHOWN)**



**D. CAST ONE-PIECE LUGGAGE RACK ('12-LATER VRSCDX SHOWN)**

**D. CAST ONE-PIECE LUGGAGE RACK\***

Beautifully die-cast, polished and finished in satin chrome, the one-piece design features hidden mounting hardware for a seamless style. The long rearward sweep continues the lines of the rear fender and the angular design blends with the passenger pillion for a true custom look. The rack looks great alone or can be installed with the matching Cast Sissy Bar Upright for added functionality. Installation requires drilling holes in rear fender.

**53315-09** Chrome. **\$184.95**  
Fits '09-later VRSCF models.

**50300028** Gloss Black. **\$184.95**  
Fits '12-later VRSCDX models.

**E. LOW SISSY BAR UPRIGHTS**

Designed to blend with the sleek look of the VRSC™ model, this easily removable upright attaches directly to the Fender Base Plate for a clean look. Hardware included.

Fits '06-'07 VRSCR and '07-'11 VRSCAW, VRSCD, VRSCDX and VRSCX models. Requires separate purchase of Fender Base Plate P/N 51138-07, 51220-07 or 51120-07.

**51162-06** Chrome. **\$69.95**

**51313-07** Gloss Black. **\$69.95**

Fits '02-'06 VRSCA, VRSCB, VRSCD and '05 VRSCSE models. Requires separate purchase of Fender Base Plate P/N 51120-01A or 51140-04A.

**51126-01A** Chrome. **\$69.95**

**Shown with:**

**LUGGAGE RACK FOR VRSC™ MODELS\***

This Luggage Rack is the ideal option for your ride across town or across the state. This rack is designed specifically for the VRSC motorcycle and the simple installation requires the use of a Fender Base Plate. Easily removed with simple tools. Chrome hardware included.

Fits '02-'11 VRSC models (except VRSCF) equipped with a Fender Base Plate.

**51119-01A** Chrome. **\$124.95**

**51142-04A** Gloss Black. **\$124.95**

**F. FENDER BASE PLATE KITS**

Styled to give your VRSC motorcycle street appeal, this Base Plate provides the attachment point for upright and luggage rack options. This great-looking Base Plate can be left in place to complement the fender styling or it can be easily removed with simple tools for a quick return to stock configuration. Kit includes chrome mounting hardware.

Fits '07-'11 VRSCAW, VRSCDX and VRSCX models.

**51138-07** Chrome. **\$209.95**

**51220-07** Gloss Black. **\$209.95**

Fits '02-'06 VRSCA, VRSCB, VRSCD and '05 VRSCSE models. Does not fit VRSCSE2 or models equipped with Wide Tire Kit P/N 43687-06 or 43820-05.

**51120-01A** Chrome. **\$99.95**

**G. CHROME HARDWARE KITS – VRSC SISSY BAR AND LUGGAGE RACK**

Finish the show-winning look with brilliant chrome hardware.

**1. 94112-04** Sissy Bar Upright and Base Plate. **\$24.95**

Fits '02-'11 VRSC models (except VRSCF) equipped with a Fender Base Plate and a Sissy Bar Upright.

**2. 94263-04** Luggage Rack. **\$24.95**

Fits '02-'11 VRSC models (except VRSCF) equipped with Luggage Rack P/N 51119-01A or 51142-04A.



**E. LOW SISSY BAR UPRIGHT – CHROME (SHOWN WITH LUGGAGE RACK)**



**E. LOW SISSY BAR UPRIGHT – GLOSS BLACK (SHOWN WITH LUGGAGE RACK)**



**F. FENDER BASE PLATE KIT – CHROME SHOWN**



**G. CHROME HARDWARE KITS – VRSC SISSY BAR AND LUGGAGE RACK**



**\*WARNING:** Do not use this rack as a seat. Do not exceed the fender rack weight capacity. Using as seat or exceeding this capacity could cause handling problems which could result in loss of control and death or serious injury.

*Notice: The prices appearing in this catalog are the manufacturer's suggested retail prices. Actual retail prices may vary.*



## 42 VRSC™

### Saddlebags

#### A. V-ROD MUSCLE® RIGID SADDLEBAGS

Maximize your touring capabilities with these extra-large capacity saddlebags without detracting from the sleek styling of the VRSCF model. These saddlebags feature a molded synthetic tub wrapped in durable vinyl with perforated vinyl accents to match the Original Equipment seat. The large interior is accessed through an easy-to-open water-resistant zippered flap and the powerful magnetic catch holds everything in place. The complete kit includes all necessary hardware for installation of saddlebags and side-mount license plate. Luggage capacity: 2950 cubic inches total.

**91172-09** **\$799.95**

Fits '09-later VRSCF models.

#### Also available:

#### TRAVEL-PAK SADDLEBAG LINERS (not shown)

**91885-97A** **\$59.95**

Fits '93-later Touring models equipped with Color-Matched Hard Saddlebags and '09-later VRSCF models equipped with Rigid Saddlebags P/N 91172-09 (pair).

#### B. SPORT SADDLEBAGS

Add practical storage to your pavement-devouring hot rod. Styled to complement the knife-edge tail section of the 2012-later Night Rod® Special models, these saddlebags provide all the room you need for a weekend on the road. The bags feature a rigid plastic tub to help maintain their shape and a soft-touch face for packing flexibility. The double zipper top closure provides easy access to the generous interior and the external zippered pocket is the ideal spot to keep cell phones, maps and gloves. Wrapped in ballistic nylon, the tight-weave UV-resistant surface features a complementing "V-ROD" logo patch stitched to a textured black band. Complete kit includes left and right bag, mounting brackets and all required installation hardware. Luggage capacity: 1400 cubic inches total.

**90200493** **\$749.95**

Fits '12-later VRSCDX models.

#### C. SPORT SADDLEBAGS

These full-featured, handcrafted saddlebags have been designed to complement the VRSC™ motorcycle's sporting image. The ballistic nylon construction and "VRSC" logo add durability and style that builds on the VRSC family's muscular image. The Sport Saddlebags can be quickly removed from the available mounting supports for carrying ease and feature exterior pockets, an interior pouch and a large dual zipper opening. Kit includes left and right detachable bags and rain covers. Luggage capacity: 1900 cubic inches total.

**91136-07A** **\$379.95**

Fits '02-'11 VRSC models (except VRSCF and VRSCSE). Installation requires separate purchase of model-specific Saddlebag Mounting Hardware.

#### Also available:

#### SADDLEBAG MOUNTING HARDWARE KIT

Required to install VRSC Saddlebag P/N 91441-06A or 91136-07A.

**91432-07** **\$299.95**

Fits '07-'10 VRSCAW, '07-'11 VRSCDX and '07-'08 VRSCX models.

**91440-06** **\$299.95**

Fits '02-'06 VRSCA, VRSCB and VRSCD models.



A. V-ROD MUSCLE RIGID SADDLEBAGS



B. SPORT SADDLEBAGS – '12-LATER VRSCDX



C. SPORT SADDLEBAGS – '02-'11 VRSC





**D. DOCUMENT HOLDER**



**E. AIR BOX COVER BRA**

**D. DOCUMENT HOLDER**

This Document Holder provides a convenient storage space under the VRSC™ hinged seat or in saddlebags. The clear zip-closure pouch attaches to the underside of the seat or to the interior of a saddlebag with convenient hook-and-loop strips and the pouch can be removed and replaced with a simple lift and pull.

**94206-03** **\$10.95**  
Fits '02-later VRSC models (except VRSCR).

**E. AIR BOX COVER BRA**

Protect the finish of your VRSC model's air box cover from scratches caused by keys, belt buckles and road debris. This "tank" bra is made with non-abrasive, fleece-backed vinyl and features an embroidered Bar & Shield logo. Designed for easy installation and a custom fit.

**57850-01** **\$59.95**  
Fits '02-later VRSC models (except VRSCF).

**F. FRAME BAG**

Great for small items like cell phones and sunglasses, this compact bag tucks neatly in the left side of the frame for a clean look.

**94204-03A** **\$34.95**  
Fits '02-later VRSC models (except VRSCR).

**G. FUEL CELL SIDE COVER KIT – CHROME**

Fill the side openings in the V-Rod® motorcycle's hydro-formed frame with a dash of chrome. This two-piece kit conceals the fuel tank and ignition switch housing and adds a contrasting shine to the silver or black frame rails. Easy to install and no hardware required.

**66310-02** **\$69.95**  
Fits '02-'06 VRSCA, VRSCB and VRSCD models.

**H. VENTED SIDE COVERS – CHROME**

Add a deeply contoured look to the VRSC model's aggressive frame with a dash of chrome. These chrome-plated steel Side Covers feature a recessed black vent for a distinctive appearance. Easy-to-install kit includes left and right covers and chrome-plated mounting hardware.

**66331-05** **\$99.95**  
Fits '02-later VRSC models (except VRSCF).

**I. VOLTAGE REGULATOR COVER – CHROME**

With a look that creates its own electricity, this chrome-plated cover features an embossed Bar & Shield logo and an open-center grill that allows air to flow right through for regulator cooling. Designed for easy installation. Chrome-mounting hardware included.

**74497-03** **\$44.95**  
Fits '02-'07 VRSC models. Will not fit with Engine Guard P/N 49267-01, 49275-06 or 49388-09.



**F. FRAME BAG**



**G. FUEL CELL SIDE COVER KIT – CHROME**



**H. VENTED SIDE COVERS – CHROME**



**I. VOLTAGE REGULATOR COVER – CHROME**

*Notice: The prices appearing in this catalog are the manufacturer's suggested retail prices. Actual retail prices may vary.*



# 44 VRSC™

## Engine Trim

### A. CHROME VRSC™ ENGINE KIT

Upgrade your silver and black motor with brilliant chrome components. Kit includes upper and lower cam covers, clutch actuator cover, sprocket cover, water pump cover, clutch cover, derby cover, alternator cover and all gaskets.

**16309-04A** \$999.95

Fits '04-later VRSC™ models (except VRSCF). Stock on VRSCA and VRSCAW models.

### B. CHROME HARDWARE KIT – VRSC CAM COVER

Kit includes chrome washers and smooth socket head metric screws made to Harley-Davidson specifications. Kit includes the hardware required to replace the visible set of zinc-plated fasteners on the cam cover.

**94014-03** Fits '02-later VRSC models. \$39.95

### C. CHROME HARDWARE KIT – VRSC CLUTCH HOUSING AND WATER PUMP

Kit includes chrome washers and smooth socket head metric screws made to Harley-Davidson specifications. Kit includes the hardware required to replace the visible set of zinc-plated fasteners on the clutch cover, secondary clutch actuator cover and water pump cover.

**94002-03** Fits '02-later VRSC models. \$69.95

### D. CHROME HARDWARE KIT – VRSC ALTERNATOR COVER AND FRONT SPROCKET COVER

Kit includes chrome washers and smooth socket head metric screws made to Harley-Davidson specifications. Kit includes the hardware required to replace the visible set of zinc-plated fasteners on the alternator cover, derby cover and front sprocket cover.

**94001-03** Fits '02-later VRSC models. \$59.95

### E. CLASSIC CHROME SOCKET HEAD BOLT COVERS – METRIC

Finish the show-winning look with these easy-to-install hardware covers. These machined brass and chrome-plated covers are corrosion resistant and the internal spring steel retention clip resists vibration and thermal cycling to securely hold the covers in place. Metric M6 size fits most engine hardware on the V-Rod® model.

**94046-03** \$38.95

Fits M6 metric socket head screws with hex drive. Sold in package of 10.



A. CHROME VRSC ENGINE KIT



B. CHROME HARDWARE KIT – VRSC CAM COVER



C. CHROME HARDWARE KIT – VRSC CLUTCH HOUSING AND WATER PUMP



D. CHROME HARDWARE KIT – VRSC ALTERNATOR COVER AND FRONT SPROCKET COVER



E. CLASSIC CHROME SOCKET HEAD BOLT COVERS – METRIC

Notice: The prices appearing in this catalog are the manufacturer's suggested retail prices. Actual retail prices may vary.





**F. COOLANT HOSE COVER KIT**



**G. BRAIDED STAINLESS STEEL COOLANT LINE**

**F. COOLANT HOSE COVER KIT**

Chrome Coolant Hose Cover picks up where the stock water pump cover leaves off. This cover extends from the tee behind the upper frame to the top of the water pump. All necessary mounting hardware is included.

**29770-01** **\$46.95**  
Fits '02-later VRSC™ models. Will not fit with Braided Stainless Steel Coolant Line P/N 26792-01.

**G. BRAIDED STAINLESS STEEL COOLANT LINE**

Add the performance look that only braided steel can provide with this custom Coolant Line Kit. Complemented by machined billet aluminum chrome-plated end caps for exact fitment and flawless function.

**26792-01** Fits '02-later VRSC models. **\$95.95**

**H. THERMOSTAT HOUSING – CHROME**

The ideal complement to the Revolution® engine, this Chrome Thermostat Housing looks great against the silver or the black finish. Manufactured from Original Equipment components for superior fit, this thermostat housing is polished and plated to a brilliant shine.

**26808-04** Fits '02-later VRSC models. **\$69.95**

**I. BILLET CAM COVER MEDALLION KIT – CHROME**

These mirror-finished chrome-plated cam cover inserts add a touch of chrome to the VRSC model's silver heads. The domed contour catches your eye and is a perfect complement to the Billet Front Sprocket Inserts P/N 44493-02. Easy installation with high-strength adhesive backing. Kit includes four medallions.

**44497-02** Fits '02-later VRSC models. **\$38.95**

**J. OIL TEMPERATURE DIPSTICK WITH LIGHTED LCD READOUT**

Add function and style by replacing the stock dipstick with this hardworking version, which includes a chrome-plated cap and LCD (liquid crystal display) oil temperature readout. The readout is push-button activated with an automatic shut-off in 5 seconds and can be programmed to stay illuminated for up to 15 minutes. The easy-to-read blue light display can be switched from Fahrenheit to Celsius. Display orientation is adjustable for viewing angle. Includes replaceable lithium battery.

**62982-03B** **\$109.95**  
Fits '02-later VRSC models (except VRSCF).

**66000107** CR2032 3V. **\$3.95**  
Lithium Replacement Battery.

**K. OIL TEMPERATURE DIPSTICK**

Replace your Original Equipment oil dipstick with this custom-styled version featuring an easy-to-see mechanical temperature readout with "Harley-Davidson" logo. A knurled, chrome-plated aluminum cap completes the styling and provides an easy grip for removal.

**62962-01A** **\$39.95**  
Fits '02-later VRSC models (except VRSCF).



**H. THERMOSTAT HOUSING – CHROME**



**I. BILLET CAM COVER MEDALLION KIT – CHROME**



**J. OIL TEMPERATURE DIPSTICK WITH LIGHTED LCD READOUT**



**K. OIL TEMPERATURE DIPSTICK**

*Notice: The prices appearing in this catalog are the manufacturer's suggested retail prices. Actual retail prices may vary.*



# 46 VRSC™

Chassis Trim

## A. FRONT FORK SLIDERS – CHROME

Competitively priced, these chrome-plated Lower Fork Sliders give your bike upfront style. To ensure proper fitment and function, these sliders are manufactured from Original Equipment components. Form follows function, with polished triple chrome-plating and a stamped “Harley-Davidson” logo for product identification. Kit includes right and left side sliders.

**46526-02B** **\$449.95**  
Fits '02-'11 VRSC™ models (except VRSCF and VRSCF).

## B. FRONT AXLE NUT COVERS

Cover the front axle in style. Available in chrome or gloss black finish, custom Axle Nut Covers look great with Original Equipment satin-finish fork sliders or add the finishing touch to a complete chrome or blacked-out front end. These Axle Cover Kits are easy to install and include all necessary mounting hardware. Sold in pairs.

Fits '02-'11 VRSC (except VRSCF, VRSCF and '12-later VRSCDX), '15-later XG, '08-later XL, '08-later Dyna®, '07-later Softail® (except Springer™, FXCW, FXCWC, FLSTNSE, FXSBSE, FXST-Aus and FXSTD) and '08-later Touring and Trike models.

<b>44117-07A</b>	Chrome – Die-cast.	<b>\$27.95</b>
<b>43000026</b>	Gloss Black – Die-cast.	<b>\$27.95</b>
<b>44116-07A</b>	Chrome – Billet.	<b>\$42.95</b>
<b>43428-09</b>	Gloss Black – Billet.	<b>\$42.95</b>

## C. “H-D MOTOR CO.” LOGO FRONT AXLE NUT COVERS

Die-cast, chrome-plated covers feature the “Harley-Davidson Motor Co.” logo in black. Includes set screws and Allen® wrench for easy installation.

**44148-07A** **\$29.95**  
Fits '02-'11 VRSC (except VRSCF, VRSCF and '12-later VRSCDX), '15-later XG, '08-later XL, '08-later Dyna, '84-later Softail (except Springer, FXCW, FXCWC, FXSB, FXSBSE, FXST-Aus, FXSTD and FLSTNSE) and '08-later Touring and Trike models.

## D. WILLIE G SKULL FRONT AXLE NUT COVERS

Add a little attitude to your ride. Styled to complement Harley-Davidson® Skull accessory items, the menacing raised skull with black-filled eyes leaps from a field of chrome. The surrounding “Harley-Davidson Motorcycles” script is the perfect finishing touch. The Axle Nut Covers are easy-to-install and include all necessary mounting hardware. Sold in pairs.

**43163-08A** **\$34.95**  
Fits '02-'11 VRSC, (except VRSCF, VRSCF and '12-later VRSCDX), '15-later XG, '88-later XL, '91-later Dyna, '84-later Softail (except Springer, FXCW, FXCWC, FXSB, FXSBSE, FXSTD and FLSTNSE) and '99-later Touring and Trike models.



A. FRONT FORK SLIDERS – CHROME



B. FRONT AXLE NUT COVERS – CHROME



B. FRONT AXLE NUT COVERS – GLOSS BLACK



C. “H-D MOTOR CO.” LOGO FRONT AXLE NUT COVERS



D. WILLIE G SKULL FRONT AXLE NUT COVERS

Notice: The prices appearing in this catalog are the manufacturer's suggested retail prices. Actual retail prices may vary.





**E. ALUMINATOR FRONT AXLE NUT COVERS**



**F. TAPERED FRONT AXLE NUT COVERS**



**G. LOW-PROFILE FRONT AXLE NUT COVERS**



**H. BURST FRONT AXLE NUT COVERS**



**I. CHROME CALIPER SCREEN INSERT – (FRONT SHOWN)**



**J. SCREAMIN' EAGLE FORK BRACE – CHROME**



**E. ALUMINATOR® FRONT AXLE NUT COVERS**

Chrome-plated billet aluminum axle covers feature a classic Bar & Shield logo insert. Includes all necessary mounting hardware for easy installation.

**44114-07 \$42.95**

Fits '02-'11 VRSC™ (except VRSCF, VRSCR and '12-later VRSCDX), '08-later Dyna®, '07-later Softail® (except Springer™, FXCW, FXCWC, FXSB, FXSBSE, FXST-Aus, FXSTD and FLSTNSE) and '08-later Touring models.

**F. TAPERED FRONT AXLE NUT COVERS**

Thanks to an exclusive contoured profile, these unique chrome die-cast Front Axle Nut Covers appear smaller than others when installed.

**44109-07 \$27.95**

Fits '02-'11 VRSC (except VRSCF, VRSCR and '12-later VRSCDX), '08-later Dyna, '07-later Softail (except Springer, FXCW, FXCWC, FXSB, FXSBSE, FXSTD and FLSTNSE) and '08-later Touring models.

**G. LOW-PROFILE FRONT AXLE NUT COVERS**

Thanks to the tapered design, these die-cast Low-Profile Axle Covers appear smaller than a traditional axle cover. The brilliant chrome finish looks great with Original Equipment polished or accessory chrome fork sliders and the hidden fasteners keep the look clean.

**47646-09 \$46.95**

Fits '06-'11 VRSC models (except VRSCF, VRSCR and '12-later VRSCDX) and '08-later Dyna models (except FXDSE).

**H. BURST FRONT AXLE NUT COVERS**

Finish your blacked-out forks in style. Rich black and prismatic machined surfaces provide the contrast and the race-track ridges and the inner spider design make a powerful visual statement. Easy-to-install kit includes mounting hardware.

**43000031 \$69.95**

Fits '02-'11 VRSC (except VRSCF, VRSCR and '12-later VRSCDX), '15-later XG, '08-later XL, '08-later Dyna, '07-later Softail (except Springer, FXCW, FXCWC, FXSB, FXSBSE, FXSTD and FLSTNSE) and '08-later Touring and Trike models.

**I. CHROME CALIPER SCREEN INSERT**

Chrome-plated caliper inserts replace the Original Equipment satin-finish screens featured on Brembo® Brake Calipers. Easy pop-in installation. Sold individually.

Fits '06-later VRSC and '08-later Touring models.

**42054-05 Front. \$29.95**

**42053-05 Rear. \$29.95**

**J. SCREAMIN' EAGLE® FORK BRACE – CHROME**

These chrome fork braces are machined from billet aluminum, then polished and chrome-plated to complement the curve of the front fender. The machined Screamin' Eagle® logo finishes the look with crisp detail. Easy-to-install, these braces offer increased torsional rigidity. Does not fit with Fluted Fork Slider Dust Covers.

**46595-06A \$219.95**

Fits '06-later FXD, FXDB, FXDC, FXDL and '02-'08 VRSCA, VRSCB, VRSCD and VRSCX models.

*Notice: The prices appearing in this catalog are the manufacturer's suggested retail prices. Actual retail prices may vary.*



# 48 VRSC™

## Chassis Trim

### A. UPPER BELT GUARD – CHROME

A must-have accessory for all V-Rod® motorcycle owners, this decoratively polished and chrome-plated Upper Belt Guard offers custom styling to an already radical bike. Mount it using your Original Equipment mounting hardware. Instructions included for easy installation.

**60837-07** **\$159.95**

Fits '07-later VRSC™ models (except VRSCR).

**60469-01A** **\$169.95**

Fits '02-'06 VRSC (except '06 VRSCSE2) and '07 VRSCR models.

#### Shown with:

### LOWER BELT GUARD – CHROME

Chrome out the entire belt and sprocket area with the addition of this uniquely styled, chrome-plated accessory. Featuring a one-of-a-kind shape and an outlined Bar & Shield logo, it's also styled to match the chrome Upper Belt Guard for seamless integration when installed together. Kit comes complete with hardware and instructions for installation.

**60839-07** **\$104.95**

Fits '07-later VRSC models (except VRSCR).

**60484-01B** **\$109.95**

Fits '02-'06 VRSC (except '06 VRSCSE2) and '07 VRSCR models.



A. UPPER AND LOWER BELT GUARDS – CHROME

### B. REAR AXLE COVERS

This one-piece axle cover blends into the unique styling of the rear swingarm and covers the rear axle and axle adjuster for a finished look.

Fits '02-later VRSC models.

**45621-02** Chrome. **\$46.95**

**43430-09** Gloss Black. **\$46.95**



B. REAR AXLE COVERS – CHROME



B. REAR AXLE COVERS – GLOSS BLACK

### C. SWINGARM PIVOT BOLT COVERS

Complete the radical styling of your VRSC model's swingarm with these custom Pivot Bolt Covers. Easy press-fit installation. Sold in pairs.

Fits '02-later VRSC models.

**48893-01** Chrome. **\$29.95**

**47647-09** Gloss Black. **\$29.95**



C. SWINGARM PIVOT BOLT COVERS – CHROME



C. SWINGARM PIVOT BOLT COVERS – GLOSS BLACK

### D. MUFFLER END CAP KIT

These die-cast and chrome-plated aluminum End Caps surround the exhaust outlet and add a finishing touch to the flowing lines of the V-Rod exhaust. Complete kit includes two End Caps and all required mounting hardware. Installation requires drilling mounting holes.

**65000-04** **\$84.95**

Fits '02-'10 VRSCA, VRSCB and VRSCX models equipped with Original Equipment muffler.



D. MUFFLER END CAP KIT

### E. BILLET MUFFLER CLAMP KIT – CHROME

Complete the flowing lines of the VRSC™ mufflers with brilliant chrome. These highly polished and chrome-plated machined billet aluminum clamps provide the perfect finishing touch to the long and lean VRSC exhaust. These clamps replace the Original Equipment strap muffler clamps, are reusable and fit with the Original Equipment or Screamin' Eagle® Slip-On Mufflers.

**65271-03** **\$104.95**

Fits '02-'10 VRSCA, VRSCAW, VRSCB and VRSCX models equipped with Original Equipment mufflers.



E. BILLET MUFFLER CLAMP KIT – CHROME

*Notice: The prices appearing in this catalog are the manufacturer's suggested retail prices. Actual retail prices may vary.*





NEW



NEW

**F. BRAKE CALIPER KIT – RED (41300116 SHOWN)**

**F. BRAKE CALIPER KIT – RED**

Dress your bike in the latest high-performance look. Brilliant red calipers make a powerful visual statement and set your bike apart from the ordinary. Manufactured from Original Equipment components for proven performance, these calipers will add a stylish touch to the stock bike or add the perfect finish to a complete custom equipped with chrome or blacked-out wheels, rotors and fork sliders.

**41300116** Front – Dual Disc. **\$499.95**  
Fits '06-later VRSC™, '08-later Touring and '09-'13 Trike models. Brake pads sold separately.

**41300120** Front – Dual Disc. **\$399.95**  
Fits '02-'05 VRSC, '00-'03 XL, '00-'07 Dyna and '00-'07 Touring models with dual disc front brakes. Brake pads sold separately.

**G. BRAKE CALIPER KIT – CHROME**

Add the shine of chrome to your bike with these highly polished Chrome Brake Caliper Kits. Manufactured from Original Equipment components for proven performance, these calipers are a great addition to the stock bike or add the finishing touch to a complete custom equipped with chrome wheels, rotors, fork sliders and swingarm. (Brake pads not included.)

**42012-06A** Front – Dual Disc. **\$899.95**  
Fits '06-later VRSC, '08-later Touring and '09-'13 Trike models.

**44392-00A** Front – Dual Disc. **\$799.95**  
Fits '00-'03 XL, '02-'05 VRSC and '00-'07 Dyna®, Softail® and Touring models equipped with dual disc front brakes.

**H. REAR BRAKE CALIPER KIT – CHROME**

With H-D® chrome behind you, you're cruising with confidence. This Rear Caliper Kit offers a brilliant, long-lasting chrome finish while delivering Original Equipment performance and exact fit. Bolts right to existing mounting holes. (Brake pads and pad pins not included.)

**44539-02A** Rear. **\$419.95**  
Fits '00-'07 FL Softail (except '07 FLSTF), '00-'05 FX Softail (except FXSTD) and '02-'04 VRSC models. Not for use with accessory Wide Tire Kits.



NEW



NEW

**F. BRAKE CALIPER KIT – RED (41300120 SHOWN)**



**G. BRAKE CALIPER KIT – CHROME (42012-06A SHOWN)**



**G. BRAKE CALIPER KIT – CHROME (44392-00A SHOWN)**



**H. REAR BRAKE CALIPER KIT – CHROME**

*Notice: The prices appearing in this catalog are the manufacturer's suggested retail prices. Actual retail prices may vary.*



## 50 VRSC™

### Wheels & Brake Rotors

#### A. V-ROD® 5-SPOKE WHEEL – BLACK ICE

Bravin is back. Five big and beefy spokes define the distinctive hot rod styling and the knife-edge shape provides an angular spin on the traditional custom wheel look. Treated to the exclusive Black Ice finish, these mirror-smooth wheels add an incredible depth and shimmer that is impossible to reach with an ordinary "black chrome" finish. Pick your styling direction; the rich black finish blends easily into a blacked-out bike, but the wet-look shimmer holds its own in the company of chrome as well. All Genuine Motor Accessory wheels have been certified by Harley-Davidson to perform to our tough vehicle standards for fit, quality and durability. Wheels require separate purchase of model-specific Wheel Installation Kit, Sprocket hardware and Brake Rotor-specific hardware. See I-sheet for details.

Fits '09-later VRSCF models and '12-later VRSCDX models.

<b>55082-11</b>	18" Rear.	<b>\$699.95</b>
<b>55083-11</b>	19" Front.	<b>\$599.95</b>

#### B. 5-SPOKE CAST ALUMINUM WHEEL

Dress your V-Rod® motorcycle in the latest style. First introduced on the 2008 Night Rod® model, these black and polished 5-Spoke Wheels add a touch of attitude to your early VRSC™ model.

**43634-08** 19" Front. **\$559.95**

Fits '02-'07 VRSC™ models. Original Equipment on '08 VRSCD. Requires separate purchase of model-specific Wheel Installation Kit. '07 VRSCX models and other models equipped with laced front wheel also require additional purchase of (2) Front Brake Rotors P/N 44553-06A.

**43635-08** 18" Rear (180/55 Tire). **\$559.95**

Fits '02-'06 VRSCA and VRSCB models and '06-'08 VRSCD and VRSCR models. Does not fit models equipped with 240mm rear tire. Requires separate purchase of model-specific Wheel Installation Kit.

#### C. POLISHED BRAKE ROTORS

A perfect complement to stock or custom wheels. Manufactured to Original Equipment specifications for exact fit, these rotors are meticulously polished to achieve a chrome-like appearance. Rotors are sold individually and include chrome installation hardware.

**41500012A** Front. **\$149.95**

Fits '06-later VRSC and Dyna® models. Also Fits '08-later Touring and Trike models. Requires Original Equipment or Accessory wheel with 6.7" bolt circle rotor mount. Does not fit Enforcer or Impeller wheels.



A. V-ROD 5-SPOKE WHEEL – BLACK ICE



B. 5-SPOKE CAST ALUMINUM WHEEL



C. POLISHED BRAKE ROTORS

*Notice: The prices appearing in this catalog are the manufacturer's suggested retail prices. Actual retail prices may vary.*



REDUCED REACH AND STANDARD VRSCDX HANDLEBAR COMPARED

**D. BLACK HANDLEBAR FOR NIGHT ROD® SPECIAL**

Complete the transition to the "dark side." Elegant satin-black finished handlebar retains the comfortable contour of the Original Equipment bar and complements the black finished hand controls and mirrors.

**56981-07** Fits '07-'11 VRSCDX models. **\$99.95**

**E. REDUCED REACH® HANDLEBAR\***

With a shape designed to place the handlebar closer to the rider, this Reduced Reach® Handlebar puts the rider in an upright seating position for added comfort and control. Bar provides 4.0" pull back and 1.5" of rise over stock VRSCDX handlebar. When combined with a Reduced Reach Seat P/N 52024-01 and Reduced Reach Control Kit P/N 50360-04, the VRSCDX model can be configured to provide a compact hand-seat-foot relationship for the shorter rider. Satin black handlebar complements the VRSCDX's dark side. Original Equipment on '12-later VRSCDX models.

**57466-10** Satin Black. **\$99.95**

Fits '06-'08 VRSCD and '07-'11 VRSCDX models. VRSCDX models require the separate purchase of additional components. Also fits VRSCF models with separate purchase of Riser and Clamp Kit P/N 55900008.



D. BLACK HANDLEBAR FOR NIGHT ROD SPECIAL

**57466-10 VRSCDX Black Reduced Reach Handlebar**

'06-'08 VRSCD require: **Orig. Equipment Style**

Clutch Lines	<b>Stock</b>
Throttle/Idle Cables	<b>Stock</b>
Brake Lines: Non-ABS	<b>Stock</b>
ABS models	<b>Stock</b>

'07-'08 VRSCDX require: **Orig. Equipment Style**

Clutch Lines	<b>Stock</b>
Throttle/Idle Cables	<b>Stock</b>
Brake Lines: Non-ABS	<b>44736-06B</b>
ABS models	<b>42264-08A</b>

'09-'11 VRSCDX require: **Orig. Equipment Style**

Clutch Lines	<b>Stock</b>
Throttle/Idle Cables	<b>56593-04, 56594-04</b>
Brake Lines: Non-ABS	<b>44736-06B</b>
ABS models	<b>42264-08A</b>

**VRSCD/VRSCDX HANDLEBAR COMPARISON**

Handlebar P/N	Standard Bar	Reduced Reach Bar
	(OE VRSCDX shape) <b>56981-07</b>	(OE VRSCD shape) <b>57466-10</b>
Tip-to-Tip	30.50"	28.80"
Base Width	7.00"	7.00"
Pull Back	3.25"	6.25"
Rise (Tip-to-Base)	3.50"	5.70"
Knurl Center-to-Center	3.50"	3.14"
Bar Diameter	1.00"	1.00"



E. REDUCED REACH HANDLEBAR – VRSCDX SHOWN



E. REDUCED REACH HANDLEBAR – VRSCF SHOWN

\*NOTE: Installation of some handlebars and risers may require a change in clutch and/or throttle cable and brake hose for some models. Handlebar height is regulated in many areas. Check local laws before installation.

Notice: The prices appearing in this catalog are the manufacturer's suggested retail prices. Actual retail prices may vary.



## 52 VRSC™

### Hand Controls

#### A. V-ROD MUSCLE® RISER AND CLAMP KIT\*

Love the look and feel of the V-Rod Muscle® motorcycle but feel a little "stretched out" in your reach to the bar? This unique riser and clamp will allow you to replace the Original Equipment cast drag bar with the Reduced Reach® Handlebar P/N 57466-10. The 1.0" diameter Reduced Reach Handlebar puts the rider in an upright seating position for added comfort and control. The bar and riser combination provides 2.0" pull back when compared to the stock VRSCF handlebar. Installation retains the factory hand controls and turn-signal style mirrors and no additional cables or lines are required.

**55900008** **\$149.95**

Fits '09-later VRSCF models.

#### B. WINDSHIELD ADAPTOR KIT

Required for installation of Quick-Release Compact Windshield P/N 57610-09 on V-Rod Muscle models equipped with Reduced Reach Handlebar and Riser And Clamp Kit P/N 55900008.

**57400128** **\$99.95**

Fits '09-later VRSCF models equipped with Reduced Reach Handlebar and Handlebar Riser and Clamp Kit P/N 55900008.

#### C. HAND CONTROL LEVER KIT

Continue the "blacked-out" or chrome theme with these Hand Control Levers. Cast from aluminum, these levers feature a custom finish designed to match the black or chrome hydraulic clutch components and Original Equipment-style hand controls.

Fits '06-later VRSC™ models.

**42270-06B** Chrome. **\$159.95**

**42275-07A** Black. **\$99.95**

Fits '02-'05 VRSC and '96-'06 Dyna®, Softail® and Touring models equipped with hydraulic clutch.

**46114-07** Chrome. **\$119.95**



A. V-ROD MUSCLE RISER AND CLAMP KIT



B. WINDSHIELD ADAPTOR KIT



C. HAND CONTROL LEVER – CHROME  
(42270-06B SHOWN)



C. HAND CONTROL LEVER – BLACK  
(42275-07A SHOWN)



C. HAND CONTROL LEVER – CHROME  
(46114-07 SHOWN)

\*NOTE: Installation of some handlebars and risers may require a change in clutch and/or throttle cable and brake hose for some models. Handlebar height is regulated in many states. Check state or local laws before installation.

Notice: The prices appearing in this catalog are the manufacturer's suggested retail prices. Actual retail prices may vary.



**D. CHROME CLUTCH BRACKET AND MASTER CYLINDER RESERVOIR KIT**

**D. CHROME CLUTCH BRACKET AND MASTER CYLINDER RESERVOIR KIT**

**D. CHROME CLUTCH BRACKET AND MASTER CYLINDER RESERVOIR KIT**

Replace your stock painted aluminum controls with brilliant chrome, without compromising quality. This kit is manufactured from the Original Equipment components and includes Chrome Master Cylinder Cover. When combined with Chrome Switch Housing Kit, Chrome Switch Caps and other Harley-Davidson® Genuine Motor Accessories, this front brake control kit provides a look that does more than stop your bike – it can stop traffic.

**42100-06A** Fits '06-later VRSC™ models. **\$639.95**

**46112-02D** **\$399.95**

Fits '02-'05 VRSC models. Also fits hydraulic clutch equipped '96-'05 Dyna®, Softail® and '96-'04 Touring models with dual disc front brakes.



**D CHROME CLUTCH BRACKET AND MASTER CYLINDER RESERVOIR KIT (42100-06A SHOWN)**

**D. CHROME CLUTCH BRACKET AND MASTER CYLINDER RESERVOIR KIT (46112-02D SHOWN)**

**E. SWITCH HOUSING KIT – CHROME**

Convert your housings from black to chrome with this complete kit. Includes left, right, upper and lower housings. No switches or wiring required. Installation instructions included.

**70222-96B** **\$139.95**

Fits '96-later VRSC, '96-'13 XL, '08-'12 XR and '96-'13 FLHR models. Also fits '96-'11 Dyna and '96-'10 Softail models. Does not fit FXSTDSE and FLHRSE models.

**F. SWITCH CAP KIT – CHROME**

Not satisfied until everything you see is chrome? This Chrome Switch Cap Kit will add style to one of the most visible areas of your bike, the switches. Shaped for the same ergonomic feel as the Original Equipment hand control switches, these caps replace the stock black caps without re-wiring. The chrome switch caps complement other chrome hand control accessories (Chrome Master Cylinder Kit, Chrome Hand Levers, Chrome Switch Housings and Chrome Master Cylinder Cover) to complete the custom look.

**71804-03** **\$24.95**

Fits '96-later VRSC and '96-'13 XL, XR and FLHR models. Also fits '96-'11 Dyna, '96-'10 Softail models and '98-'01 FLHR models. FLHR models equipped with Cruise Control Use Kit P/N 71808-03.

**G. MASTER CYLINDER COVER KIT – CHROME**

Update the view over the handlebar with a touch of chrome. Kit includes left and right Master Cylinder Reservoir Covers and all necessary installation hardware.

**42114-06A** Fits '06-later VRSC models. **\$129.95**

**H. MASTER CYLINDER COVER KIT – CHROME**

Includes one chrome-plated cover, gasket and decal. Easily installed with included stainless steel screws.

**45078-96D** **\$39.95**

Fits '96-'03 XL, '02-'05 VRSC, '96-'05 Dyna and Softail and '96-'04 Touring models.



**E. SWITCH HOUSING KIT – CHROME**

**F. SWITCH CAP KIT – CHROME**



**G. MASTER CYLINDER COVER KIT – CHROME '06-LATER MODELS**

**H. MASTER CYLINDER COVER KIT – CHROME '02-'05 MODELS**

*Notice: The prices appearing in this catalog are the manufacturer's suggested retail prices. Actual retail prices may vary.*



## 54 VRSC™

### Foot Controls

#### A. SLOTTED SHIFT LEVER

The high style of the VRSC™ model is reflected in this sweeping open-design shift lever. Available in your choice of mirror-chrome or satin black, the slotted billet design and integral molded rubber pad with Bar & Shield logo is a look that will get noticed. Install the matching Slotted Brake Lever for a complete look.

Fits '02-later VRSC™ models (except VRSCD and VRSCR).

<b>34555-01A</b>	Chrome.	<b>\$169.95</b>
<b>34551-09</b>	Satin Black.	<b>\$169.95</b>



A. SLOTTED SHIFT LEVER – CHROME



A. SLOTTED SHIFT LEVER – SATIN BLACK

#### B. SLOTTED REAR BRAKE LEVER

Styled to complement the lean and low look of the VRSC motorcycle, the open-slotted design of this brake lever adds a custom touch to your stock forward controls. Available in your choice of mirror-chrome or satin black, this Slotted Brake Lever includes a matching ribbed brake pedal pad with embossed Bar & Shield logo. Complete the look with a matching Slotted Shift Lever.

Fits '02-later VRSC models (except VRSCD and VRSCR).

<b>42964-01A</b>	Chrome.	<b>\$169.95</b>
<b>48983-09</b>	Satin Black.	<b>\$169.95</b>



B. SLOTTED REAR BRAKE LEVER – CHROME



B. SLOTTED REAR BRAKE LEVER – SATIN BLACK

#### C. REDUCED REACH FOOTPEG KIT

Designed with the shorter rider's ergonomics in mind, this chrome-finished kit offers a different riding option for V-Rod models. When used alone, this kit moves the footpegs back and up 1.0". When used in conjunction with a Reduced Reach Seat your reach is reduced up to 2.0", giving you maximum riding comfort.

**50270-02A** **\$139.95**

Fits '02-'11 VRSC models (except VRSCD and VRSCR).  
Original Equipment on VRSCF models.

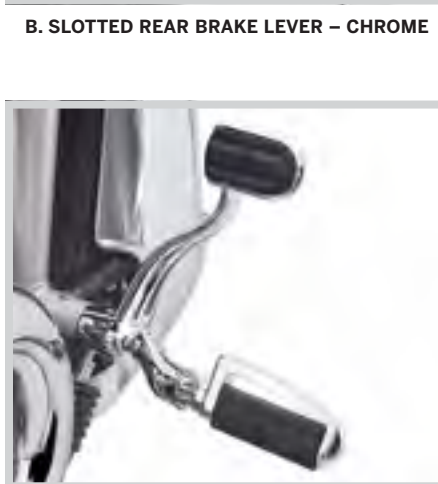

C. REDUCED REACH FOOTPEG KIT

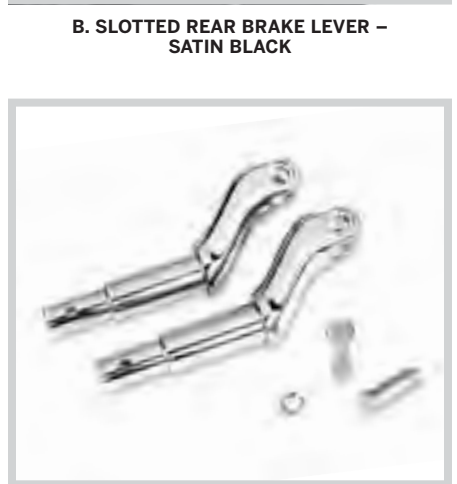

#### D. "V-ROD" SCRIPTED GEAR SHIFT LINKAGE

With the custom looks of the V-Rod® model, stock just won't do. So kick your customizing into gear with a polished stainless steel Gear Shift Linkage. Featuring aircraft-quality rod ends, a stainless steel transmission lever cover and decorative acorn nuts for maximum custom effect. The polished, stainless steel finish won't chip, peel or discolor. Easy-to-install.

**33867-02** **\$159.95**

Fits '02-'11 VRSC models (except VRSCD, VRSCF and VRSCR). Will not fit with Reduced Reach® Control Kit P/N 50360-04.



D. "V-ROD" SCRIPTED GEAR SHIFT LINKAGE

*Notice: The prices appearing in this catalog are the manufacturer's suggested retail prices. Actual retail prices may vary.*



**E. V-ROD MID-CONTROL KIT – LEFT SIDE**



**E. V-ROD MID-CONTROL KIT – RIGHT SIDE**

**E. V-ROD® MID-CONTROL KIT**

Convert your V-Rod® Night Rod® Special to a sport-oriented mid-control riding position. Ideal for riders with a short inseam length or for riders who prefer an aggressive riding posture, this complete kit moves the foot brake and shift lever from the standard forward control position to a mid-control location. The installation changes the riding stance from a laid-back, foot-forward, straight leg cruising profile to an upright, foot-down, bent knee sport profile. The kit includes left and right footpeg supports, brake and shift lever assemblies, brake and shift linkages, rear master cylinder and all required hardware.

**50700013 \$499.95**

Fits '07-later VRSCDX models. ABS equipped models require separate purchase of Brake Lines P/N 42268-08A and 42285-08A. Non-ABS models require separate purchase of Brake Line P/N 41968-07A.

**F. JIFFY STAND – CHROME**

With this beautifully chrome-plated accessory, your VRSC™ model won't just stand on its own – it will stand out. Using the Original Equipment jiffy stand to ensure quality and fitment, this piece is polished and plated to decoratively enhance a very visual component on the vehicle. Reuses Original Equipment spring for installation.

**49742-01A \$79.95**

Fits '02-later VRSC™ models (except VRSCR and VRSCF).

**G. ENGINE GUARD KIT\***

Protect your Revolution® engine in style. The unique S-curve shape adds style to function. The Engine Guard features a two-piece design that allows for easy radiator service. Each side can be removed independently by simply removing two bolts.

Fits '02-later VRSC (except VRSCR) models. Will not fit with Regulator Cover P/N 74496-03 and 74497-03 or with VRSCSE Chin Fairing.

**49267-01A Chrome. \$309.95**

**49388-09 Gloss Black. \$309.95**

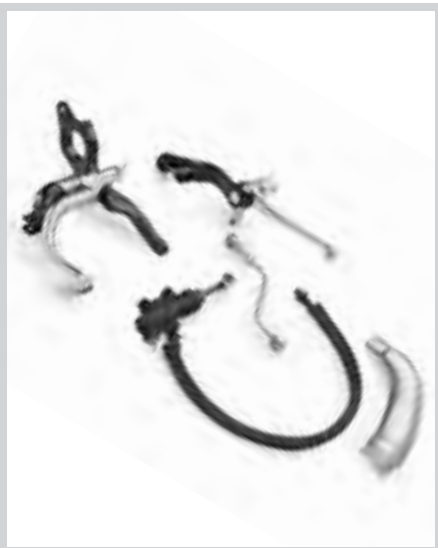

**E. V-ROD MID-CONTROL KIT**



**F. JIFFY STAND – CHROME**



**G. ENGINE GUARD KIT – CHROME**



**G. ENGINE GUARD KIT – GLOSS BLACK**



**\*WARNING:** Engine guards may provide limited leg and cosmetic vehicle protection under unique circumstances (fall over while stopped, very low speed slide). They are not made nor intended to provide protection from bodily injury in a collision with another vehicle or any other object.

*Notice: The prices appearing in this catalog are the manufacturer's suggested retail prices. Actual retail prices may vary.*



## 56 VRSC™

### Lighting

#### A. BILLET HEADLAMP SHELL

Add style and substance to the front fork with this bullet-shaped Headlamp Shell. Manufactured from billet aluminum, this extended headlamp housing recesses the headlamp for a true custom appearance. The mirror-finish chrome surfaces and the close-fitting inner trim ring create the appearance of a one-piece design. Kit includes chrome-plated mounting hardware and a custom billet mount.

**67704-03** **\$339.95**

Fits '00-later FXS, FXSB, FXSBSE, FXST, FXSTB, FXSTC, FXSTD and '99-'05 FXDWG models. Also fits '02-'11 VRSC™ models (except VRSCF) equipped with Installation Bracket P/N 68211-05. Not Compatible with LED headlamps. (Does not fit International models.)

#### B. BILLET HEADLAMP INSTALLATION BRACKET

Add to the long and lean look of the VRSC model family. This bracket allows you to replace the Original Equipment headlamp with the mirror-chrome extended Billet Headlamp Shell.

**68211-05** **\$179.95**

Fits '02-'11 VRSCA, VRSCAW, VRSCB, VRSCD and VRSCX models. Requires separate purchase of Billet Headlamp Shell Kit P/N 67704-03 and Headlamp Bulb P/N 68297-05. VRSCD models require removal of Original Equipment Color-Matched Speed Screen Visor.

#### C. TURN SIGNAL RELOCATION KIT

Styled to blend with the lower triple clamp. This chrome-plated Turn Signal Relocation Kit moves the Original Equipment bullet-style turn signals from the handlebar to the front fork for a clean, streamlined look. Kit includes left and right mounting stalk and all required hardware.

**57205-05** **\$45.95**

Fits '02-'10 VRSCA, VRSCB, VRSCD and '07-'11 VRSCX and VRSCDX models.

#### D. CONTOURED HEADLAMP TRIM VISOR

Draped around the curving profile of the distinctive sloping V-Rod® headlamp, this mirror-finish visor blends with the headlamp mounting bracket for a true custom look. Designed to direct light away from the leading edge of the windshield, this styled visor looks great with or without a windshield.

**69236-04** **\$35.95**

Fits '02-'10 VRSCA, VRSCAW, VRSCX, VRSCR and '04 VRSCB models.

#### E. HEADLAMP TRIM RING – GLOSS BLACK

Finish the Dark Custom look by replacing the Original Equipment chrome headlamp trim ring with sinister black. Easy-to-install, the ring's rich black surface matches the stock headlamp shell finish for a unified look.

**67700116** 5-3/4" Headlamp. **\$29.95**

Fits '05-'11 VRSCD/X/A/XA, '04-later XL883L, XL883N, XL883R, XL1200R, XL1200N, XL1200X, '04-'11 XL883C, XL1200C, '93-later Dyna® (except FLD and FXDF) and '11-later FXS models.



**A. BILLET HEADLAMP SHELL (SHOWN WITH INSTALLATION BRACKET AND TURN SIGNAL RELOCATION KIT)**



**B. BILLET HEADLAMP INSTALLATION BRACKET**



**C. TURN SIGNAL RELOCATION KIT**



**D. CONTOURED HEADLAMP TRIM VISOR**



**E. HEADLAMP TRIM RING – GLOSS BLACK (IRON 883 SHOWN)**

*Notice: The prices appearing in this catalog are the manufacturer's suggested retail prices. Actual retail prices may vary.*



**F. TURN SIGNAL LENS KIT – SMOKED**



**G. CHROME BULLET REAR TURN SIGNAL KIT FOR VRSC MODELS**

**F. TURN SIGNAL LENS KIT**

Add a unique touch to your bike. These Turn Signal Lens Kits replace the amber lenses for a clean front and rear appearance. Meets DOT requirements.

Fits '00-later models (except VRSC™, XL883N, XL1200N, XL1200X and FXS) with Bullet Turn Signals. Will also fit V-Rod models equipped with Chrome Turn Signal Kit P/N 69374-05. Kit includes 4 lenses and 4 amber bulbs.

<b>69303-02</b>	Clear – Bullet Lens.	<b>\$39.95</b>
<b>69304-02</b>	Smoked – Bullet Lens.	<b>\$39.95</b>

**G. CHROME BULLET REAR TURN SIGNAL KIT FOR VRSC™ MODELS**

Replace the Original Equipment rear flat black bullet turn signal housings with brilliant chrome. Kit includes chrome-plated bullet-style turn signal housings, chrome rear supports and amber-colored lenses.

<b>69374-05A</b>		<b>\$99.95</b>
Fits '02-'11 Domestic VRSCA, VRSCB, VRSCD (except '12-later VRSCDX) and '07 VRSCX models.		

**H. CUSTOM LED TAIL LAMP**

Function and style in one. Twenty-three brilliant red LED lamps are set in a mirror-finished chrome inner reflector. The "diamond cut" facets shape and direct the light and add a style all their own. Available with a red or clear outer lens, the installed lens adds a red metallic or chrome finishing touch to the rear fender. Featuring easy plug-in connection to the Original Equipment wiring harness. Meets DOT and TÜV requirements.

Fits '02-'11 VRSC models (except VRSCF and '12-later VRSCDX) and '00-'07 FXSTD models.

<b>69367-07</b>	Clear Lens with Chrome Reflector.	<b>\$139.95</b>
<b>69366-07</b>	Red Lens with Chrome Reflector.	<b>\$139.95</b>



**H. CUSTOM LED TAIL LAMP – CLEAR LENS**



**H. CUSTOM LED TAIL LAMP – RED LENS**

**I. CHROME TAIL LIGHT COVER**

Dress your tail lamp in style. This chrome-plated Tail Light Cover follows the contour of the lens for a custom look. Self-adhesive backing for easy installation.

<b>68478-05</b>		<b>\$29.95</b>
Fits '02-'06 VRSC models and '07-'08 VRSCD and VRSCR models with 180mm rear tire.		

**J. CHROME LICENSE PLATE MOUNT COVER**

Show off your tail. This chrome-plated cover fits over the stock fender mount license plate bracket. This mirror-finished cover features a custom reflector with graphics. Includes mounting hardware for cover and license plate.

<b>59726-04</b>		<b>\$36.95</b>
Fits '04-'11 VRSC models (except VRSCF and '12-later VRSCDX).		



**I. CHROME TAIL LIGHT COVER**



**J. CHROME LICENSE PLATE MOUNT COVER**

*Notice: The prices appearing in this catalog are the manufacturer's suggested retail prices. Actual retail prices may vary.*



GENUINE MOTOR PARTS &amp; ACCESSORIES



2015

## SPORTSTER®

Since 1957, Sportster® motorcycles have set the standard for the no-nonsense pursuit of two-wheeled freedom and adventure. Today, they are available in more distinct looks than ever, to give you a running start on building your own unique machine.







SPORTSTER®

## SUPERLOW®

XL883L | PRODUCTION COLOR: VIVID BLACK

This 883 SuperLow® model is as easy on the eyes as it is to ride. The blacked-out Screamin' Eagle® air cleaner and exhaust, fork sliders, and mini-wind deflector complement the Vivid Black paint and hard saddlebags. And the Reduced Reach Solo Seat and further forward mid foot controls give you more room to maneuver this light and agile motorcycle.

SEE WHAT'S ON THIS BIKE AT [H-D.COM/GALLERY](https://www.harley-davidson.com/gallery)





SPORTSTER®

## IRON 883™

XL883N | PRODUCTION COLOR: HARD CANDY QUICKSILVER FLAKE

Ride the line between no-nonsense bobber and cool café racer with this muscular ride. Black Ice Machete wheels and red brake calipers stand out against the contrast cut Burst Collection controls, while the Screamin' Eagle® Stage I air cleaner and Street Cannon mufflers add the thrust to keep you plastered against the metal flake solo seat.

SEE WHAT'S ON THIS BIKE AT [H-D.COM/GALLERY](https://www.harley-davidson.com/gallery)



SPORTSTER®

## 1200 CUSTOM

XL1200C | PRODUCTION COLOR: BRILLIANT SILVER/VIVID BLACK

Some looks never go out of style. From the sparkling hand controls to the Daymaker™ LED headlamp, and from the Machete wheels to the tip of the Street Cannon mufflers, chrome is king on this two-tone beauty. But it's not only about style – the two-up Rallyrunner® seat and the sissy bar backrest cradle you and your passenger in luxury and comfort.





SPORTSTER®

**SUPERLOW® 1200T**

XL1200T | PRODUCTION COLOR: DEEP JADE PEARL / VIVID BLACK

Stretch your legs on the Mustache engine guard, and eat up the miles on this luxurious motorcycle. The windshield and saddlebags are ready for touring and the Reduced Reach solo seat, quick-release rider backrest and Circulator seat pad add comfort for the long haul. Finish it off with abundant chrome touches that show your personal style.







SPORTSTER®

# SEVENTY-TWO®

XL1200V | PRODUCTION COLOR: BLACK QUARTZ

A few key mods are all it takes to turn this Seventy-Two® model into a long, low hot rod. The rolled-down Drag Bar puts riders in a café racer position. The distressed leather and brass rigid-mount Bobber Solo Saddle takes "minimal" to a new level, and the narrow whitewall tires and retro Smooth Air Cleaner Cover add a nostalgic touch.

SEE WHAT'S ON THIS BIKE AT [H-D.COM/GALLERY](https://www.harley-davidson.com/gallery)





SPORTSTER®

## FORTY-EIGHT®

XL1200X | PRODUCTION COLOR: HARD CANDY BIG RED FLAKE

The first thing you notice on this Forty-Eight® model is the eye-popping Hard Candy Big Red Flake paint on the classic "peanut" gas tank. But don't miss the edgy Chizeled bars\*, Burst Collection foot controls, and the white piping on the Black Diamond Solo Spring Saddle that add a bit of flair and anchor the bike in old-school cool.

SEE WHAT'S ON THIS BIKE AT [H-D.COM/GALLERY](https://www.harley-davidson.com/gallery)

\*Handlebar height is regulated in many areas. Check local laws before installing.



SEVENTY-TWO® TRANSFORMATION

CUSTOM CLASSIC

With an authentic '70s chopper attitude, Hard Candy Custom™ paint, and loads of chrome, the Seventy-Two® model rolls off the factory floor as a low-rider-inspired radical custom.

We've taken this custom Seventy-Two® motorcycle even deeper into a classic era with a number of well-chosen enhancements. Taking their cues from the stock whitewall tires, nostalgic white hand grips and the White Diamond Solo Saddle set a decidedly retro tone. The black piping

gives this classic seat a striking look, while its external springs soften the ride. The chrome Chizeled handlebar\*, low-set Tribal mirrors and the chrome swingarm complete the profile, while the Screamin' Eagle® Street Cannon slip-on mufflers boost performance to thoroughly modern levels.



\*Handlebar height is regulated in many areas. Check local laws before installing.

Parts list available at [h-d.com/gallery](http://h-d.com/gallery)



FIT

The Chizeled handlebar\* provide an upright "fists in the wind" riding posture with a '70s lane-splitting narrow profile. For a clean, custom look, the "Z" bar features cast mitered corners for easy internal wiring.



FUNCTION

Cool can be practical. Equipped for a run to the pool hall or for a night on the town, this narrow and nimble ride is perfect for squeezing through traffic. Add a swingarm bag, and you can stash your stuff in style.



CARE AND MAINTENANCE

While it's tempting to use standard "auto parts store" cleaning and service supplies, hold out for the real thing. Genuine Harley-Davidson® coolant, oils, filters, batteries and service parts are engineered for the unique surfaces and operating conditions your Harley® motorcycle will encounter.



CHIZELED BAR & CUSTOM HAND CONTROLS



SCREAMIN' EAGLE® STREET CANON MUFFLERS



STYLE

With its smooth metal seat pan and simple frame cover, the Solo Spring Saddle delivers a clean, finished old-school look—without any frame cutting or modifications. So you can always install a traditional two-up seat when you want to take someone along for the ride.



PERFORMANCE

The Screamin' Eagle® Street Cannon slip-on mufflers provide free flow of exhaust gases with just the right amount of back pressure for a smooth-running ride, an exhaust note with extra deep bass, and performance you can feel.



CRAFTSMANSHIP

We design and build the bikes, so we don't need to "reverse-engineer" parts to try and make them fit. Everything we make is rigorously tested to ensure it meets our high standards, and the finishes of our accessories match the bike's surfaces for a consistent appearance.



CHROME SWINGARM, AXLE COVER & POLISHED ROTOR



WHITE DIAMOND SOLO SPRING SADDLE



# 74 SPORTSTER®

## Windshields

### A. COMPACT SPORT WIND DEFLECTOR

Shaped to smooth the wind flow around the headlamp and handlebar mount gauges, this compact bikini screen is the ideal addition to your ride. Sitting just above the headlamp, the Compact Wind Deflector maintains the stripped-down minimalist attitude of the Sportster motorcycle while adding a clean, custom look. The easy-to-install dark polycarbonate screen attaches to the fork tubes with chrome-plated adjustable clamps. Kit includes all mounting hardware.

**57400184** **\$249.95**

Fits '04-later XL models (except '11-later XL1200C).



A. COMPACT SPORT WIND DEFLECTOR

### B. SPORT WINDSHIELD KIT

Formed of polycarbonate and hard-coated to resist scratching. Light smoke windshield is contoured to fit the headlamp and incorporates adjustable four-point mounting. Functional styling helps deflect wind to reduce upper body fatigue.

**58192-87A** 17" Light Smoke. **\$164.95**

Fits '88-later XL (except XL Custom, XL1200T, XL1200X and '11-later XL883L) and '95-'05 Dyna® models (except FXDWG and FXDXT). Includes black mounting hardware. Windshield dimensions: Overall height – 18.5"; width – 16.3".

**58024-96A** 17" Light Smoke. **\$174.95**

Fits '96-'10 XL Custom, XL1200X and '87-'94 FXLR models. Also fits '99-'00 FXR models. Windshield dimensions: Overall height – 19.1"; width – 16.3".



B. SPORT WINDSHIELD KIT –  
(58192-87A SHOWN)



B. SPORT WINDSHIELD KIT –  
(58024-96A SHOWN)

### C. QUICK-RELEASE SUPER SPORT WINDSHIELD

Reduces the pounding of wind and shower of bugs but keeps the wind-in-the-hair feeling. Ideal for a cool morning ride, the sleek profile of the Super Sport Windshield hugs the front headlamp for a sporty look. The windshield mounts to the fork tubes with elegant die-cast lever locking clamps, so the windshield does not require any "leave-behind" docking hardware. You get quick on-and-off convenience and a clean, custom look. No tools are required and the kit includes everything needed to install the windshield.

Fits '08-'13 XR1200™ models.

**57262-08** 11" Gradient. **\$344.95**

Windshield dimensions: Overall height – 13.8"; width – 12.8".

**57260-08** 13" Light Smoke. **\$344.95**

Windshield dimensions: Overall height – 18.7"; width – 13.8".



C. QUICK-RELEASE SUPER SPORT  
WINDSHIELD – 11"



C. QUICK-RELEASE SUPER SPORT  
WINDSHIELD – 13"

Notice: The prices appearing in this catalog are the manufacturer's suggested retail prices. Actual retail prices may vary.





D. QUICK-RELEASE SUPER SPORT WINDSHIELD

**D. QUICK-RELEASE SUPER SPORT WINDSHIELD**

Reduces the pounding of wind and shower of bugs, but keeps the wind-in-the-hair feeling. Ideal for a cool morning ride, the sleek profile of the Super Sport Windshield hugs the front headlamp for a sporty look. The windshield mounts to the fork tubes with elegant die-cast lever locking clamps, so the windshield does not require any "leave-behind" docking hardware. You get quick on-and-off convenience and a clean, custom look. No tools are required and the kit includes everything needed to install the windshield.

**57838-08** 19" Light Smoke. **\$324.95**

Fits '88-later XL (except XL1200T, XL1200X, '11-later XL883L and XL1200C) and '91-'05 Dyna® models (except FXDWG and FXDXT). XL Custom models require Front Directional Relocation Kit P/N 68517-94A. Windshield dimensions: Overall height – 25.0"; width – 20.1".

**E. QUICK-RELEASE COMPACT WINDSHIELD**

Combine the classic Harley-Davidson® windshield shape with a revolutionary new attachment system and you have the best of style and function. The windshield mounts to the fork tubes with elegant die-cast lever-release clamps, so the windshield does not require any "leave-behind" docking hardware. You get quick on-and-off convenience and a clean, custom look. No tools are required and the kit includes everything needed to install the windshield. The tough, hard-coated polycarbonate windshield is available with traditional polished or gloss black horizontal and vertical braces.

Fits '88-later XL (except XL1200T, XL1200X, '11-later XL883L and XL1200C) and '91-'05 Dyna models (except FXDWG and FXDXT).

**58063-04** 18" Clear – Polished Braces. **\$369.95**

Windshield dimensions: Overall height – 26.8"; width – 19.7".

**58706-09** 18" Clear – Black Braces. **\$389.95**

Windshield dimensions: Overall height – 26.8"; width – 19.7".

**58601-04** 18" Light Smoke – Polished Braces. **\$399.95**

Windshield dimensions: Overall height – 26.8"; width – 19.7".

**58602-04** 14" Light Smoke – Polished Braces. **\$389.95**

Windshield dimensions: Overall height – 22.8"; width – 19.5".

**58703-09** 14" Light Smoke – Black Braces. **\$419.95**

Windshield dimensions: Overall height – 22.8"; width – 19.5".

Fits '14-later XL1200T and '11-later XL883L and XL1200C models.

**57801-11** 18" Clear – Polished Braces. **\$369.95**

Windshield dimensions: Overall height 26.8"; width 19.7".

**57802-11** 14" Light Smoke – Polished Braces. **\$379.95**

Windshield dimensions: Overall height 22.8"; width 19.5".

Fits '10-later XL1200X models.

**58053-10** 19" Clear – Black Braces. **\$369.95**

Windshield dimensions: Overall height 24.0"; width 19.5".

**57682-10** 15" Light Smoke – Black Braces. **\$389.95**

Windshield dimensions: Overall height 20.0"; width 19.5".

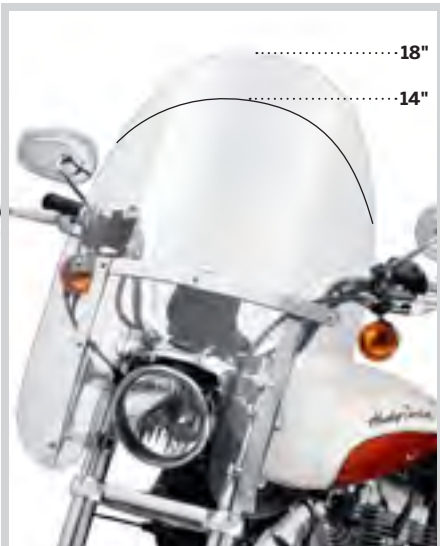

E. QUICK-RELEASE COMPACT WINDSHIELD – POLISHED BRACES



E. QUICK-RELEASE COMPACT WINDSHIELD – GLOSS BLACK BRACES





## 76 SPORTSTER®

### Windshields

#### A. H-D® DETACHABLE COMPACT WINDSHIELD FOR MODELS WITH AUXILIARY LIGHTING

Whether it's for keeping bugs off your face or warmth in your body, a windshield has a huge impact on rider and passenger comfort. By diverting air pressure past your chest and over your helmet, a windshield can add hours of riding comfort. This high-quality polycarbonate windshield mounts to the fork tubes with detachable Docking Hardware for easy on-and-off convenience and a quick return to a stripped-down profile and is shaped to fit models equipped with Auxiliary Lighting Kits.

**57400053** 18" Clear. **\$289.95**

Fits '11-later XL883L models. Also for use on '11-later XL883L Police models equipped with pursuit lamps. Requires the separate purchase of Docking Hardware Kit P/N 58164-96A and Turn Signal Relocation Kit P/N 68603-01. Windshield dimensions: Overall height – 22.7"; width – 19.5".

**57716-01** 18" Clear. **\$289.95**

Fits '88-later XL (except XL1200T, XL1200X, '11-later XL883L and XL1200C) and '91-'05 Dyna® models (except FXDWG and FXDXT) equipped with Auxiliary Lamps. Requires the separate purchase of Docking Hardware Kit P/N 58164-96A and Turn Signal Relocation Kit P/N 68603-01. Windshield dimensions: Overall height – 26.8"; width – 19.7".



A. H-D DETACHABLES COMPACT WINDSHIELD FOR MODELS WITH AUXILIARY LIGHTING

#### B. VENTILATOR QUICK-RELEASE COMPACT WINDSHIELD

In a nutshell, a windshield should provide a barrier between the rider and errant bugs, discarded cigarette butts, flying debris and bad air. The shield should manage airflow and wind blasts to create a pocket of still air for both rider and passenger comfort. But if you ride in a warm climate or spend time at low speeds stuck in traffic, you need to keep some air circulating around your body to stay comfortable. The Ventilator Windshield features clear injection molded vents that allow you to adjust the airflow to match the riding conditions. Opening the vents redirects the air across your chest for a cooling effect and closing the vents provides maximum wind and weather protection. But when you want to ride "naked," the detachable shield can be removed completely and re-installed in seconds to match your riding mood.

**57400025** 19" Clear. **\$429.95**

Fits '88-later XL (except XL1200T, XL1200X, '11-later XL883L and XL1200C) and '91-'05 Dyna models (except FXDWG and FXDXT). Windshield dimensions: Overall height – 28.0"; width – 21.4".



B. VENTILATOR QUICK-RELEASE COMPACT WINDSHIELD

B. VENTILATOR QUICK-RELEASE COMPACT WINDSHIELD — OPEN

#### C. QUICK-RELEASE TOURING WINDSHIELD

The Touring Windshield features an aerodynamic design shaped to provide hours of riding comfort. The additional center width directs airflow past the hand grips and deflects rain and road debris around the rider. The windshield mounts to the fork tubes with elegant die-cast lever-release clamps, so the windshield does not require any "leave-behind" docking hardware. You get quick on-and-off convenience and a clean, custom look. No tools are required and the kit includes everything needed to install the windshield. The tough, hard-coated polycarbonate windshield features traditional chrome horizontal and vertical braces.

**58158-08** 19" Clear. **\$439.95**

Fits '88-later XL (except XL1200T, XL1200X, '11-later XL883L and XL1200C) and '91-'05 Dyna models (except FXDWG and FXDXT). Windshield dimensions: Overall height – 28.3"; width – 22.1".



C. QUICK-RELEASE TOURING WINDSHIELD





D. H-D DETACHABLES QUARTER FAIRING KIT



E. HEADLAMP VISOR

**D. H-D® DETACHABLES™ QUARTER FAIRING KIT**

Sleek, racy styling and sweeping lines are the make-up of this innovative fairing. Its quarter-sized, detachable design gives your bike a whole new, sporty look that can be changed in an instant. Available in Primed or Vivid Black. Requires the installation of Detachable Docking Hardware Kit P/N 58164-96A.

Fits '88-later XL (except XL Custom, XL1200X, XL1200N, XL1200T, XL883N and '11-later XL883L), FXR and '95-'05 Dyna® models (except FXLR, FXDXT and FXDWG).

<b>57070-98</b>	Primed.	<b>\$279.95</b>
<b>57070-97DH</b>	Vivid Black.	<b>\$399.95</b>

**E. HEADLAMP VISOR**

Add an element of racy style to stock headlamps with these visors, available in Primed or Vivid Black.

Fits '95-later XL models (except XL Custom, XL1200V and XL1200X), '95-'05 Dyna models (except FXDWG and FXDXT), '82-'94 FXR and FXRS models.

<b>68129-97</b>	Primed.	<b>\$119.95</b>
<b>68129-98DH</b>	Vivid Black.	<b>\$229.95</b>

**F. FRONT DIRECTIONAL RELOCATION KIT**

This kit includes the required hardware and wiring to move the front directional lamps from the handlebar to the lower triple clamp.

Fits '88-later XL (except XL1200T, XL1200X, '11-later XL883L and XL1200C) and '91-'05 Dyna models (except FXDWG and FXDXT).

<b>68517-94A</b>	Chrome.	<b>\$39.95</b>
<b>68643-09</b>	Gloss Black.	<b>\$34.95</b>

**G. LOCKING QUICK-RELEASE WINDSHIELD CLAMP**

Protect your investment. This Locking Quick-Release Windshield Clamp secures your windshield from grab-and-run theft, giving you peace of mind when you have to leave your bike unattended. The chrome-plated Locking Clamp replaces one of the Original Equipment windshield clamps and features a push-button lock with a mini barrel-style key for easy removal. Kit includes one locking clamp and two matching keys.

**57400006** 39mm. **\$39.95**  
Fits '88-later XL and '91-'05 Dyna models (except FXDWG) equipped with Quick-Release Style detachable windshields.

**H. DOCKING HARDWARE FOR H-D DETACHABLES WINDSHIELDS**

Each kit includes polished clamps and all required mounting hardware.

**58164-96A** **\$79.95**  
Required for installation of H-D® Detachables™ windshields on '88-later XL (except XL1200X and '11-later XL1200C) and '91-'05 Dyna models (except FXDWG and FXDXT). XL and Dyna models with front turn signals originally located on the upper triple clamp may require the additional purchase of Turn Signal Wiring Kit P/N 72389-96.

**I. WINDSHIELD ACORN NUT KIT**

Kit contains 10 chrome-plated low crown 12-24 acorn nuts.

**94111-95** **\$9.95**  
Fits Compact, King-Size, Convertible and Road King® windshields. (Pkg. of 10.)



F. FRONT DIRECTIONAL RELOCATION KIT



G. LOCKING QUICK-RELEASE WINDSHIELD CLAMP



H. DOCKING HARDWARE FOR H-D DETACHABLES WINDSHIELDS



I. WINDSHIELD ACORN NUT KIT



## SEAT OF POWER

The right seat is equal parts ergonomics and comfort. Its shape anchors your position and determines the reach to the ground and to the controls and the padding supports your tailbone and hips to relieve stress and pressure. Pick the right one for you — and your passenger.

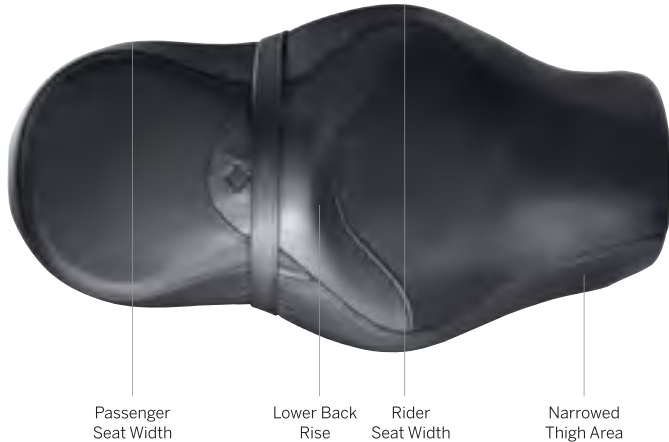

### PAMPER YOUR BEHIND



Experience ultimate comfort. Road Zeppelin® seats and seat pads are equipped with a unique air bladder system that distributes rider weight across the entire seating surface. By reducing pressure points and providing shock absorption, this pad allows you to ride your cool low-profile seat for hundreds of miles. The mesh cover lets air circulate beneath the rider's body, reducing the temperature between the rider and seat. The easy-to-reach integrated hand pump and air release valve permits quick and convenient adjustment.

### CHANGING YOUR SEAT



Switching out your seat is simple. And because certain rides call for certain styles, some folks like to have multiple seats to match the occasion. Install a comfortable, supportive touring seat for the longer treks and swap it out for a low-profile seat for a night on the town. Please see your owner's manual for proper removal and installation of seats.

### SPORTSTER® SEAT TYPES

Solo or two-up, comfort or style, check out these seats to get an idea of where you want to sit.

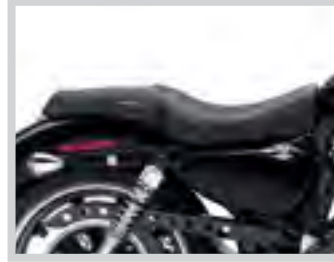

#### LOW-PROFILE SEATS

These saddles combine radical styling with a "deep-in-the-bike" riding position. Long and lean, Badlander®, Brawler® and Sidekick® seats bring you lower to the ground than most other seats.



#### REDUCED REACH® SEATS

Get even closer. This Solo Seat is shaped to move the rider 3.0" forward and 1.0" lower for a confident reach to the hand and foot controls. The narrow nose brings the legs 1.0" closer together for a comfortable reach to the ground and the scooped bucket-shape and back support keeps the rider from sliding backward during acceleration.



#### TOURING SEATS

Designed for comfort, Sundowner™ and Signature Series® seats offer a broad seating surface to reduce pressure points and a dished shape holds you in place and provides additional back support.

### CUSTOM SEAT PROGRAM

A personalized seat is the perfect thread to tie your bike's attitude together. Select the stitching pattern, leather inlay and thread color that best support your custom movement and you'll have your personalized seat in just three weeks. For more details, turn to page 796 or visit [h-d.com/customseat](http://h-d.com/customseat).







A. BRAWLER SOLO SEAT

**A. BRAWLER® SOLO SEAT**

When it's time to go it alone, go in style. These premium quality cowhide leather solo saddles feature a smooth, sleek design that hugs the frame rails for a true custom look. Top-grain leather seating surface and contoured foam padding add long-haul comfort and the durable hand-laid fiberglass seat pan is carpeted to protect the paint finish. This seat does not fit with passenger pillions.

**52940-04B** **\$299.95**

Fits '04-later XL models equipped with 4.5 gallon fuel tank.

Seat width 12.5".

**52941-04B** **\$299.95**

Fits '04-later XL models equipped with 3.3 gallon fuel tanks.

Seat width 12.5".

**52198-03** **\$299.95**

Fits '83-'03 XL models. Seat width 12.5".

**B. SIDEKICK® SEAT**

Share your custom ride with a passenger. This two-up cowhide leather seat offers a frame-hugging look, but adds back support for the rider and additional padding for the passenger. Top-grain leather seating surface and contoured foam padding add long-haul comfort and the durable hand-laid fiberglass seat pan is carpeted to protect the paint finish.

**52849-04B** **\$329.95**

Fits '04-later XL models equipped with 4.5 gallon fuel tank.

Models not equipped with passenger pegs require separate purchase of Passenger Footpeg Kit P/N 50203-04 ('04-'13 models) or P/N 50500270 ('14-later models). Seat width 12.5"; passenger pillion width 5.0".

**52859-04B** **\$329.95**

Fits '04-later XL models equipped with 3.3 gallon fuel tanks.

Models not equipped with passenger pegs require separate purchase of Passenger Footpeg Kit P/N 50203-04 ('04-'13 models) or P/N 50500270 ('14-later models). XL1200N models also require separate purchase of Retention Washer P/N 7487. Seat width 12.5"; passenger pillion width 5.0".



B. SIDEKICK SEAT

*Notice: The prices appearing in this catalog are the manufacturer's suggested retail prices. Actual retail prices may vary.*

To add custom inlays and stitching to your Brawler® or Sidekick® seat, see pages 796-797, or visit: [www.h-d.com/customseat](http://www.h-d.com/customseat).





# 80 SPORTSTER®

Seating – Solo

## A. BOBBER SOLO SADDLE

How low can you go? This minimalist solo seat takes the stripped-down garage-built look about as far as you can go. The thick distressed black leather cover is bonded directly to the formed metal seat pan and minimizes the foam filler and the extra height it brings. The raw-edge leather features brass rivets and “Milwaukee Since 1903” trim that will develop a rich patina with use and a Bar & Shield logo burned into the surface. Easy to install, the bolt-on seat and model-specific Installation Kit includes everything you need to get the bobber look. No cutting, welding or fabrication is necessary.

**52000180** Black Distressed Leather. **\$299.95**  
Fits '04-'06 XL, '10-later XL, '06-later Dyna® and '08-later FXS, FLS, FLSTC, FLSTN, FLSTF and FLSTFB models.  
Installation requires separate purchase of model-specific Rigid or Spring Saddle Mounting Hardware Kit.

## B. SOLO SADDLE

Add nostalgic “bobber” looks to your modern Harley-Davidson® motorcycle. This elegant solo seat features a low-profile design that provides the minimalistic “just enough to ride” look. The smooth metal seat pan and the simple frame cover leave a clean, finished appearance. Easy to install, the bolt-on seat and model-specific Rigid or Spring Seat Installation Kit includes everything you need to get the bobber look. No cutting, welding or fabrication is necessary and the seat can be removed and replaced with a touring seat for a two-up night on the town.

Fits '04-'06 XL, '10-later XL, '06-later Dyna and '08-later FXS, FLS, FLSTC, FLSTN, FLSTF and FLSTFB models. Installation requires separate purchase of model-specific Rigid or Spring Saddle Mounting Hardware Kit.

<b>54373-10</b>	Black Leather.	<b>\$299.95</b>
<b>54072-10</b>	Brown Leather.	<b>\$299.95</b>
<b>52000114</b>	Black Diamond.	<b>\$299.95</b>
<b>52000113</b>	White Diamond.	<b>\$299.95</b>

### Also available:

#### RIGID MOUNT SADDLE INSTALLATION KIT

Get the low lean minimalistic garage built look. Required for installation of Solo Saddle Kits P/N 52000180, 54072-10, 54373-10, 52000114 and 52000113. Kit includes mounting brackets and hardware.

**52100016** **\$229.95**  
Fits '10-later XL models.

### Also available:

#### SPRING SADDLE INSTALLATION KIT

The torsion-style springs are designed for the optimum balance between spring suspension and support. Required for installation of Solo Spring Saddle Kit P/N 52000180, 54072-10, 54373-10, 52000114 and 52000113. Kit includes springs, mounting brackets, frame cover and hardware.

**54074-10** **\$229.95**  
Fits '04-'06 and '10-later XL models.

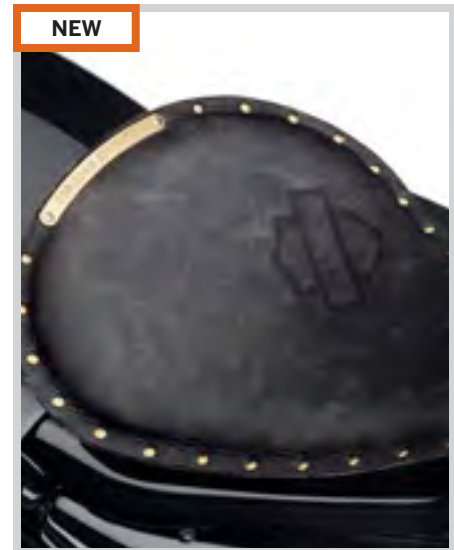

**A. BOBBER SOLO SADDLE – BLACK DISTRESSED LEATHER (SHOWN WITH RIGID MOUNT SADDLE INSTALLATION KIT)**

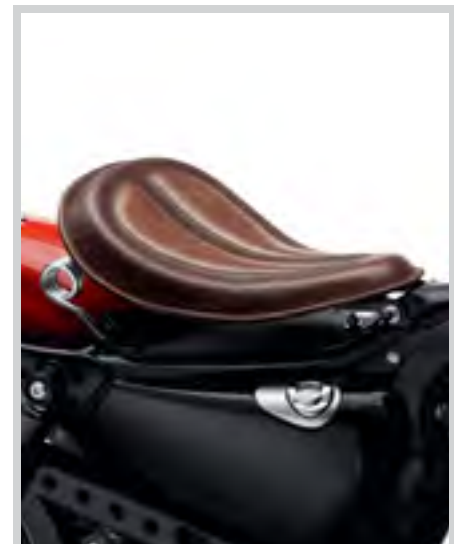

**B. SOLO SADDLE – BLACK LEATHER (SHOWN WITH SPRING SADDLE INSTALLATION KIT)**

**B. SOLO SADDLE – BROWN LEATHER (SHOWN WITH SPRING SADDLE INSTALLATION KIT)**



**B. SOLO SADDLE – BLACK DIAMOND (SHOWN WITH SPRING SADDLE INSTALLATION KIT)**

**B. SOLO SADDLE – WHITE DIAMOND (SHOWN WITH SPRING SADDLE INSTALLATION KIT)**

Note: Some Harley-Davidson seats are made of leather. Fine leathers or other natural materials WILL gain “character,” such as wrinkles or wear, with age. This is normal. A fine, aged patina and character wrinkles are a sign of the extremely high quality materials used to construct your seat or backrest. The appearance of scars or marks on the leather are a result of using natural leather panels and should not be thought of as an imperfection. Please use Harley-Davidson Leather Protectant P/N 93600034 to protect your investment.

*Notice: The prices appearing in this catalog are the manufacturer's suggested retail prices. Actual retail prices may vary.*





C. METAL FLAKE SOLO SEAT – SILVER CHARCOAL

**C. METAL FLAKE SOLO SEAT – SILVER CHARCOAL**

Add a little sparkle to your ride with this custom Metal Flake Solo Seat. With a nod to the choppers and bobbers of the '60s and '70s, this minimalistic seat features a brilliant high-gloss metal flake vinyl seating surface that is finished in the classic diamond checked upholstery pattern. The look will stop traffic and will certainly make your ride stand out in a crowd.

**52000051** **\$149.95**

Fits '10-later XL models with 2.2 or 3.3 gallon fuel tank. Seat width 10.0".

**D. SIGNATURE SERIES® SOLO SEAT WITH RIDER BACKREST**

A perfect combination of foam density and shape has created our most comfortable seat for long-haul touring. The wide-seating area will keep the rider extra comfy on a long trip and when you reach your destination, city driving will be easier with the narrow nose that helps keep your legs closer together. Seat features an easily removable adjustable rider backrest that folds down for easier passenger mounting. Rider backrest has a 5-position height adjustment with 1.5" range and a wide range of forward/back angle adjustment with a quick twist of the control knob. Matching Passenger Pillion is available for added versatility.

**52000034** **\$499.95**

Fits '07-later XL models with 4.5 gallon fuel tank. Seat width 15.0".

**52000062** **\$499.95**

Fits '07-later XL models with 2.2 or 3.3 gallon fuel tank. Seat width 15.0".



D. SIGNATURE SERIES SOLO SEAT WITH RIDER BACKREST

**E. QUICK-RELEASE RIDER BACKREST**

Add exceptional comfort for open road and around town riding. This detachable rider backrest is shaped for maximum lower back support and keeps you in place without shifting you forward in the saddle. Designed to complement Original Equipment and accessory solo seats, the backrest's forward/back position can be adjusted up to 4.5" with a simple fingertip adjustment. The fold-down pad clears the way when throwing your leg over the bike and the backrest can be removed from the bike with the push of a button—leaving behind just two elegant docking points. Complete kit includes upright, pad, fender strut brackets and all required hardware.

**52300245** **\$249.95**

Fits '04-later XL models equipped with a solo seat. Not for use with Brawler® Solo Seat P/N 52940-04B, 52941-04B, 52000118, 52000119, Solo Rigid or Spring Seat Mounting Kits or Side-Mount License Plate Kit P/N 60947-10 or 60972-10. Installation of H-D® Detachables™ Solo Luggage Rack requires additional purchase of Bolt P/N 3584 (Qty. 4).

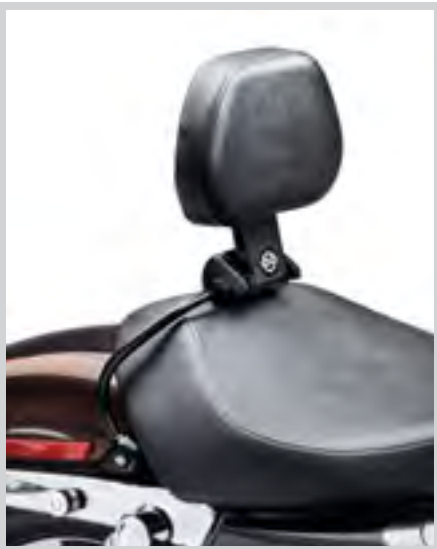

E. QUICK-RELEASE RIDER BACKREST

Note: Some Harley-Davidson seats are made of leather. Fine leathers or other natural materials WILL gain "character," such as wrinkles or wear, with age. This is normal. A fine, aged patina and character wrinkles are a sign of the extremely high quality materials used to construct your seat or backrest. The appearance of scars or marks on the leather are a result of using natural leather panels and should not be thought of as an imperfection. Please use Harley-Davidson Leather Protectant P/N 93600034 to protect your investment.

Notice: The prices appearing in this catalog are the manufacturer's suggested retail prices. Actual retail prices may vary.



## 82 SPORTSTER®

### Seating – Pillion

#### A. SIGNATURE SERIES® PASSENGER PILLION

Bring someone along for the ride without giving up your solo status. This carefully styled pillion matches the Sportster® Signature Series® Solo Seat and provides your passenger with a wide seating surface for hours of comfort.

**52400053** **\$149.95**

Fits '07-later XL models equipped with Signature Series Solo Seat P/N 52000034 or 52000062. Pillion width 10.0".

#### B. PASSENGER PILLION

Low-profile, minimalistic Passenger Pillion features grey stitching to complement the Original Equipment solo seat on XL1200V and XL1200X models. Easy to install with included hardware and grab strap.

**51734-10** **\$129.95**

Fits XL1200V and XL1200X models equipped with Original Equipment solo seat. Requires installation of passenger footpegs (sold separately). Pillion width 7.75".

#### C. PASSENGER PILLION

Bring a guest along on your solo-seat equipped Sportster model. The smooth cover and top stitching of this Passenger Pillion complements the Original Equipment solo seat and the Reduced Reach® Solo Seat. Kit includes grab strap and mounting hardware.

**51744-07A** **\$114.95**

Fits '07-later XL models (except XL1200V and XL1200X) equipped with Original Equipment or Reduced Reach® Solo Seats. Requires installation of passenger footpegs (sold separately). XL883N and XL1200N models also require separate purchase of Retention Washer P/N 7487. Pillion width 10.0".

**51546-04** **\$119.95**

Fits '04-'06 XL883 models. Requires installation of passenger footpegs (sold separately). Pillion width 9.5".

#### D. REAR FENDER BIB

Go solo in style. Form-fitted to hug the contour of the rear fender, this decorative fender cover hides the seat mounting holes that are exposed when riding with a solo seat. Wrapped in smooth vinyl to match Original Equipment or accessory solo seats, the Fender Bib features an embossed Bar & Shield logo for added style. The molded base is finished with a soft felt under-liner designed to protect the fender's painted surface.

**52017-08** **\$59.95**

Fits '04-later XL models (except XL1200T, XL1200V and XL1200X) equipped with Original Equipment solo seat or Reduced Reach Solo Seat P/N 51750-07 or 51751-07. Will not fit models equipped with Bobtail Rear Fender.

#### E. BADLANDER® SEAT

A perfect seating surface for cruising the town, this low, slammed seat offers a clean, custom look. The smooth covers and subtle top-stitching feature two embroidered "Harley-Davidson" logos.

**51749-07** **\$249.95**

Fits '07-later XL models equipped with 4.5 gallon fuel tank. Models not equipped with passenger pegs require separate purchase of Passenger Footpeg Kit P/N 50203-04 ('04-'13 models) or P/N 50500270 ('14-later models). Seat width 12.0"; passenger pillion width 5.0".

**51747-07** **\$249.95**

Fits '07-later XL models equipped with 2.2 or 3.3 gallon fuel tanks. Models not equipped with passenger pegs require separate purchase of Passenger Footpeg Kit P/N 50203-04 ('04-'13 models) or P/N 50500270 ('14-later models). XL883N, XL1200N and XL1200X models also require separate purchase of Retention Washer P/N 7487. Seat width 12.0"; Passenger pillion width 5.0".

**52296-94B** **\$249.95**

Fits '83-'03 XL models. Seat width 12.0"; passenger pillion width 5.0".



A. SIGNATURE SERIES PASSENGER PILLION



B. PASSENGER PILLION



C. PASSENGER PILLION –  
(‘04-‘06 XL883 MODELS SHOWN)



D. REAR FENDER BIB



E. BADLANDER SEAT



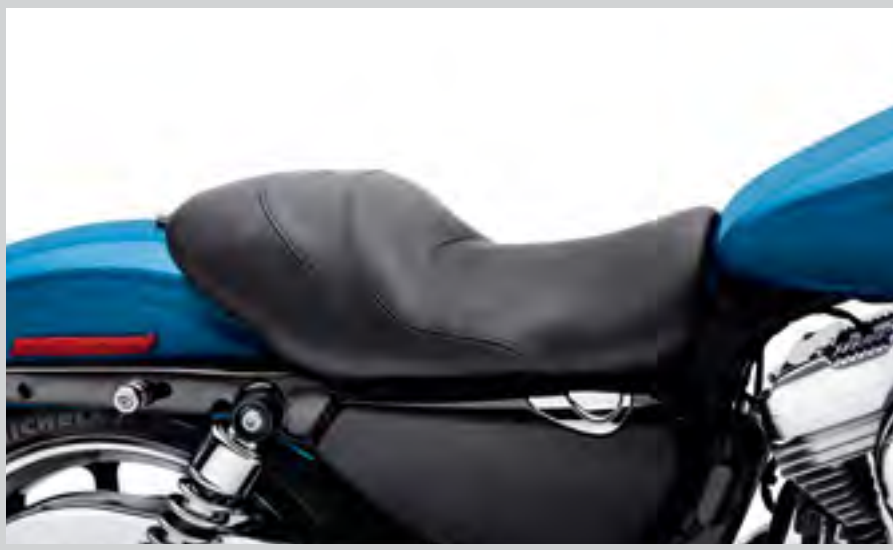

F. SUPER REDUCED REACH SOLO SEAT

**F. SUPER REDUCED REACH® SOLO SEAT**

Get a little bit closer. Super Reduced Reach® forward position seats are designed to move riders with a shorter inseam even closer to the controls and to bring the legs about 1.0" closer together so that your feet rest firmly on the pavement. The scooped bucket-shaped saddle is enhanced with added back support padding to move the rider up to 1.0" lower and 3.0" forward. The combination positions the rider closer to the hand and foot controls to offer both comfort and confidence. For a two-up ride, combine the solo seat with the Touring Passenger Pillion P/N 51744-07A (sold separately).

**54385-11** **\$229.95**

Fits '07-later XL models equipped with 4.5 gallon fuel tank. Seat width 10.5".

**54386-11** **\$229.95**

Fits '07-later XL models equipped with 2.2 or 3.3 gallon fuel tanks. XL883N, XL1200N and XL1200X models also require separate purchase of Retention Washer P/N 7487. Seat width 10.5".

**G. REDUCED REACH SOLO SEAT**

Need to get your feet firmly on the ground? This ergonomically friendly Solo Seat moves the rider .5" forward and offers a truly comfortable seating option for the rider with a shorter inseam. The wide bucket surface provides a comfortable perch for those long rides, while the narrow front brings your legs together for a more natural riding position around town.

**51751-07** **\$229.95**

Fits '07-later XL models equipped with 4.5 gallon fuel tank.

**51750-07** **\$229.95**

Fits '07-later XL models equipped with 2.2 or 3.3 gallon fuel tanks. XL883N, XL1200N and XL1200X models also require separate purchase of Retention Washer P/N 7487.

**H. LOW-PROFILE SOLO SEAT**

This Low-Profile Solo Seat offers a truly comfortable seating option for the rider with a shorter inseam. The wide bucket surface provides a comfortable perch for those long rides, while the narrow front brings your legs together for a more natural riding position around town.

**51538-04** **\$199.95**

Fits '04-'06 XL models equipped with 4.5 gallon fuel tank. Seat width 14.5".

**51538-00** **\$199.95**

Fits '83-'03 Sportster® models. Seat width 14.5".

**I. REDUCED REACH SEAT**

Designed specifically for riders requiring a close to the bar riding position, without compromising comfort. This seat positions the rider approximately .5" forward, closer to the hand and foot controls. The narrow front profile brings your legs closer together to help you plant your feet firmly on the ground. The slightly bucketed rider seat offers lower back support and features a textured insert to prevent you from sliding around while riding.

**51738-07** **\$304.95**

Fits '07-later XL models equipped with 4.5 gallon fuel tank.

Models not equipped with passenger pegs require separate purchase of Passenger Footpeg Kit P/N 50203-04 ('04-'13 models) or P/N 50500270 ('14-later models). Seat width 14.0"; passenger pillion width 10.0".

**51737-07** **\$304.95**

Fits '07-later XL models equipped with 2.2 or 3.3 gallon fuel tanks. Models not equipped with passenger pegs require separate purchase of Passenger Footpeg Kit P/N 50203-04 ('04-'13 models) or P/N 50500270 ('14-later models). XL883N, XL1200N and XL1200X models also require separate purchase of Retention Washer P/N 7487. Seat width 14.0"; passenger pillion width 10.0".

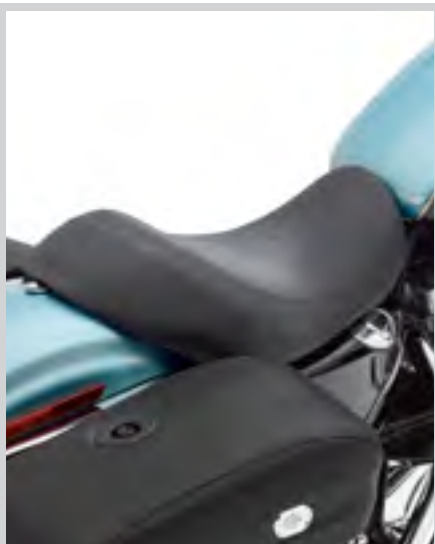

G. REDUCED REACH SOLO SEAT



H. LOW-PROFILE SOLO SEAT



I. REDUCED REACH SEAT



## 84 SPORTSTER®

Seating – Two Up

### A. RALLYRUNNER® SEAT

The two-up profile of this custom seat maintains a lean look, but adds back support for the rider and additional padding for the passenger. Made of the highest quality cowhide, this premium seat offers a radical style with a touch of comfort. Top-grain leather seating surface and contoured foam padding add long-haul comfort and the durable hand-laid fiberglass seat pan is carpeted to protect the paint finish.

**52916-04B** **\$329.95**

Fits '04-later XL models equipped with 4.5 gallon fuel tank. Models not equipped with passenger pegs require separate purchase of Passenger Footpeg Kit P/N 50203-04 ('04-'13 models) or P/N 50500270 ('14-later models). Seat width 12.5"; passenger pillion width 8.0".

**52923-04B** **\$329.95**

Fits '04-later XL models equipped with 3.3 gallon fuel tanks. Models not equipped with passenger pegs require separate purchase of Passenger Footpeg Kit P/N 50203-04 ('04-'13 models) or P/N 50500270 ('14-later models). XL1200N models also require separate purchase of Retention Washer P/N 7487. Seat width 12.5"; passenger pillion width 8.0".



A. RALLYRUNNER SEAT

### B. ROAD ZEPPELIN® AIR ADJUSTABLE SEAT

The mating of comfort and style. Low-profile Road Zeppelin® Seats are equipped with a unique adjustable air bladder system that distributes your weight across the seating surface. The air bladder system removes pressure points and provides shock absorption for the rider's and passenger's tailbone. You get hours of riding comfort, without sacrificing the low-slung custom look. The combination of smooth vinyl and waterproof textured fabric seating surfaces allows air to circulate beneath the body, reducing the air temperature between the rider and seat. The easy-to-reach integrated hand pumps and air release valves permit quick and convenient adjustment for both the rider and passenger.

**52000145** **\$549.95**

Fits '04-later XL models. Models not equipped with passenger pegs require separate purchase of Passenger Footpeg Kit P/N 50203-04 ('04-'13 models) or P/N 50500270 ('14-later models). Seat width 12.0"; passenger pillion width 10.5".



B. ROAD ZEPPELIN AIR ADJUSTABLE SEAT

### C. SUNDOWNER™ SEAT

The Sundowner™ Seat provides the maximum in long-riding comfort. The deep-bucket design puts your body in the proper touring position and the generous padding makes it comfortable for both the rider and passenger as the miles are adding up. The dish-shaped backrest provides added rider back support and the wide passenger pillion is shaped to minimize pressure points.

**51739-07** **\$319.95**

Fits '07-later XL models equipped with 4.5 gallon fuel tank. Models not equipped with passenger pegs require separate purchase of Passenger Footpeg Kit P/N 50203-04 ('04-'13 models) or P/N 50500270 ('14-later models). Seat width 14.5"; passenger pillion width 12.0".

**51736-07** **\$319.95**

Fits '07-later XL models equipped with 2.2 or 3.3 gallon fuel tanks. Models not equipped with passenger pegs require separate purchase of Passenger Footpeg Kit P/N 50203-04 ('04-'13 models) or P/N 50500270 ('14-later models). XL883N, XL1200N and XL1200X models also require separate purchase of Retention Washer P/N 7487. Seat width 14.5"; passenger pillion width 12.0".

**51507-04** **\$319.95**

Fits '04-'06 XL models equipped with 4.5 gallon fuel tank. Models not equipped with passenger footpegs require separate purchase of Passenger Footpeg Kit P/N 50203-04 ('04-'13 models) or P/N 50500270 ('14-later models). Seat width 15.0"; passenger pillion width 12.5".

**51509-04** **\$319.95**

Fits '04-'06 XL models equipped with 3.3 gallon fuel tank. Models not equipped with passenger footpegs require separate purchase of Passenger Footpeg Kit P/N 50203-04 ('04-'13 models) or P/N 50500270 ('14-later models). Seat width 15.0"; passenger pillion width 12.5".

**51544-01A** **\$319.95**

Fits '83-'03 XL models. Seat width 15.0"; passenger pillion width 12.5".

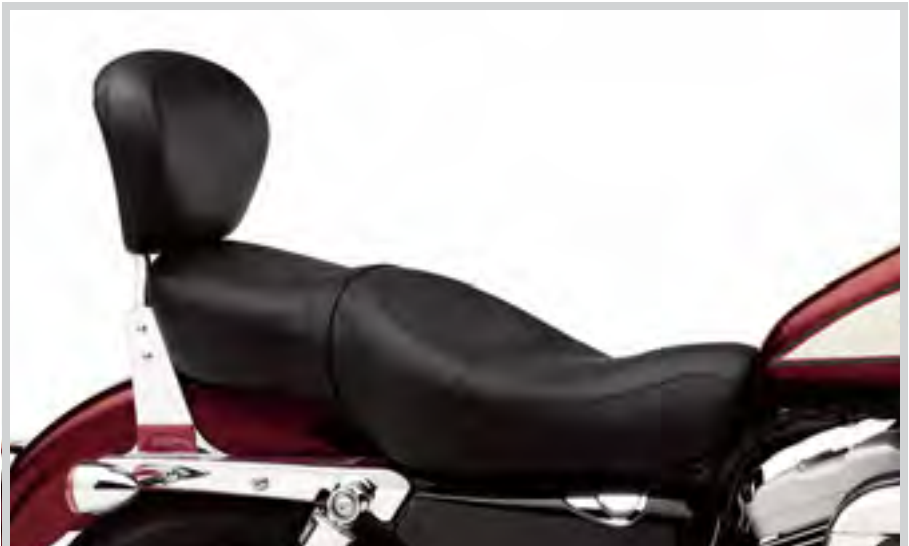

C. SUNDOWNER SEAT (SHOWN WITH SMOOTH BUCKET LOW BACKREST PAD)

*Notice: The prices appearing in this catalog are the manufacturer's suggested retail prices. Actual retail prices may vary.*



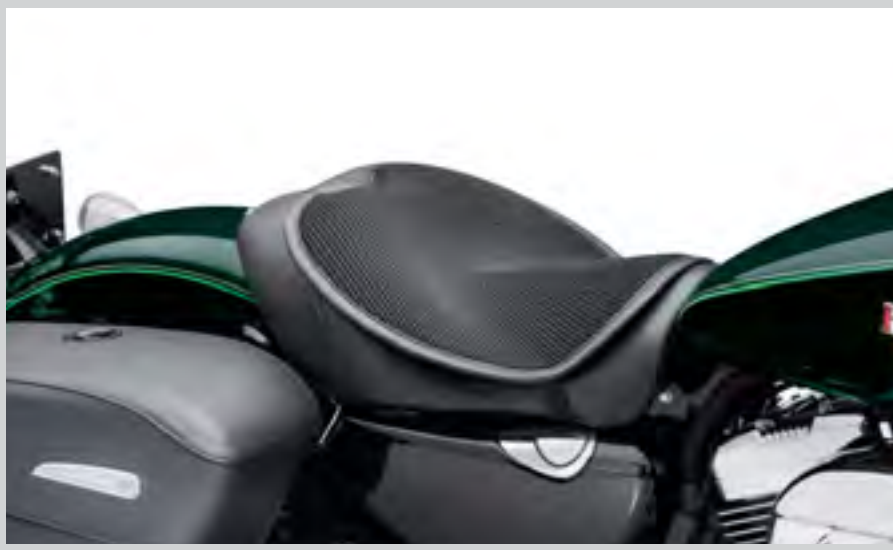

D. CIRCULATOR SEAT PAD

**D. CIRCULATOR SEAT PADS**

Keep comfortable on your next long ride. These breathable Circulator Seat Pads feature 3D construction that promotes air movement and reduces heat build-up where the rider's body touches the seat or backrest. Designed to keep the rider cool by reducing the perspiration build-up between you and the seating surface, the Circulator Pad can be installed and removed in seconds for easy cleaning. The low-profile design minimizes seat-height change compared to inflatable pads, while enhancing comfort with its shock-absorbing construction. Manufactured of UV-stable materials, these seat pads resist fading when exposed to the sun. Elastic under-seat straps and non-slip base provide secure installation and the available Circulator Passenger Pillion Pad attaches to the rider pad with hook-and-loop tabs.

**51074-10** Medium Seat Pad. **\$79.95**  
Fits VRSC™, XG, XL and Dyna® models with Original Equipment and accessory seats. Pad width – 14.5"

**51078-10** Passenger Pillion Pad. **\$69.95**  
Fits Original Equipment and accessory passenger pillions. Pad width – 13.0"

**E. ROAD ZEPPELIN® SEAT PAD**

Experience ultimate comfort. Road Zeppelin® Seat Pads are equipped with a unique air bladder system that allows your weight to be distributed evenly across the entire seating surface, ensuring hours of comfort for both rider and passenger. The air bladder system is designed to remove pressure points and provide shock absorption to reduce vibration. The mesh cover allows air to circulate beneath the rider's body, reducing the air temperature between the rider and seat. The easy-to-reach integrated hand pump and air release valve permits quick and convenient adjustment. Shaped to conform to most Harley-Davidson® seats, the pads feature an adjustable mounting strap and a non-skid surface to keep them in place.

**52000084** Rider. **\$129.95**  
Fits rider position on all models equipped with Original Equipment or accessory seats. Also fits passenger position on Touring models with large pillion area. Pad width – 14.0".

**52400060** Passenger Pillion. **\$129.95**  
Fits Original Equipment and accessory passenger pillions. Pad length – 11.0"; width – 8.0".

**F. QUICK-RELEASE SEAT HARDWARE KIT**

These hardware kits allow the rider to remove one-piece Harley-Davidson seats quickly and easily.

**51676-97A** **\$19.95**  
Fits '97-later XG, XL, Dyna, Softail® (except FLS models equipped with Original Equipment seat), Touring and Trike models. Does not fit seats equipped with spring-loaded rear seat bracket.



E. ROAD ZEPPELIN SEAT PAD



E. ROAD ZEPPELIN SEAT PAD



F. QUICK-RELEASE SEAT HARDWARE KIT

*Notice: The prices appearing in this catalog are the manufacturer's suggested retail prices. Actual retail prices may vary.*



## 86 SPORTSTER®

Backrests & Racks

### Choosing a Backrest

A sissy bar upright and passenger backrest are the starting point to build a complete touring machine. The backrest provides long-range comfort and support and adds a feeling of control and confidence for the passenger. For permanent installation, choose rigid sideplates and a style of upright that suits your riding style. For added flexibility, choose a H-D® Detachables™ Sideplate Kit and appropriate Docking Hardware to make adding or removing a detachable accessory a simple “slide and click” proposition.



#### H-D Rigid Sideplates

Add practical comfort and support for your passenger. Rigid Sideplates support are the anchor for sissy bar uprights, backrest pads and luggage racks and hug the rear fender strut for a clean streamlined look. Manufactured and tested to rigorous Harley-Davidson® standards, these sideplates are designed to specific model application for exact fit.

Fits '04-later XL models (except XL1200T). Does not fit models equipped with saree guards.

**1. 53925-04** Chrome. **\$99.95**

Fits '94-'03 XL models.

**2. 52806-94B** Chrome. **\$99.95**



1

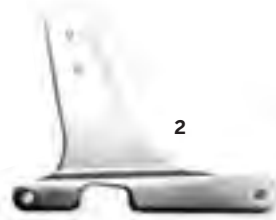

2



#### H-D® Detachables™ Sideplates

In the time it takes for a traffic light to change, you can transform your motorcycle from a city cruiser to a cross country hauler. Start with Harley-Davidson® Detachables Sideplates, and add your choice of sissy bar upright and pad to make removing the passenger backrest a simple “slide and click” operation. Manufactured and tested to rigorous Harley-Davidson® standards, installation requires separate purchase of model-specific Docking Hardware Kit.

Fits '04-later XL models. All models (except XL1200T) require separate purchase of Docking Hardware Kit (see docking hardware matrix).

**3. 53913-04** Chrome. **\$144.95**

**4. 52710-07** Gloss Black. **\$144.95**

Fits '94-'03 XL models. Requires separate purchase of Docking Hardware Kit (see docking hardware matrix).

**53545-95** Chrome. **\$144.95**



3



4



#### H-D Adjustable Sideplates

Enhance your passenger's ride with an adjustable passenger backrest. When combined with your choice of Sissy Bar Upright and Backrest Pad, these Premium Adjustable Sideplates allow the passenger to change the recline angle of the passenger backrest for maximum comfort. Simply pull on the release levers and adjust the upright to one of three different recline settings. The exclusive cam lock detachable design lets you add or remove the passenger backrest assembly in seconds.

Fits '04-later XL models. All models (except XL1200T) require separate purchase of Docking Hardware Kit.

**52300116** Chrome. **\$229.95**

**52300096** Gloss Black. **\$229.95**



Notice: The prices appearing in this catalog are the manufacturer's suggested retail prices. Actual retail prices may vary.

## Select a Height



Tall

### Tall Sissy Bar Upright

Let your passenger ride tall in the saddle with a Tall Sissy Bar Upright. This upright provides maximum upper back support when equipped with your choice of Backrest Pad.



Standard

### Standard Sissy Bar Upright

Give your passenger additional back support with a Standard Sissy Bar Upright, designed to accept a wide variety of Backrest Pads.



Low

### Low Sissy Bar Upright

Shaped to complement a thicker passenger pillion, this Low Sissy Bar Upright stands between the Standard and Short Sissy Bar Upright. The ideal match for touring style seats, this upright also offers an additional height option to riders with custom style seats.



Short

### Short Sissy Bar Upright

This Short Sissy Bar Upright is lower than traditional low uprights and the hidden Backrest Pad Mounting System allows for a sleek look when the pad is removed.

## Select a Style



**Square Bar  
Medallion Style with  
3-Bolt Pad Mount**



**Round Bar  
Mini Medallion Style  
with 3-Bolt Pad Mount**



**Round Bar  
Mini Medallion Style  
with 2-Bolt Pad Mount**

Sissy Bar Uprights are available in a variety of shapes and styles. Square bar uprights feature a traditional plate design that provides a flat surface that is ideal for displaying self-adhesive medallions. Round bar uprights feature a mini medallion bar and an embossed Bar & Shield insert. Uprights are designed to accept specific 3-bolt or 2-bolt mounted backrest pads.

## Select Your Model

Height	Bar Style	Style	Finish	Fits '82-'03 XL models		Fits '04-later XL models with Rigid Sideplates		Fits '04-later XL models with H-D® Detachables™ Sideplates	
Short	Square	Insert	Chrome	—	—	<b>51513-02</b>	<b>\$74.95</b>	<b>52737-94A</b>	<b>\$74.95</b>
Short	Square	Insert	Gloss Black	—	—	—	—	<b>52706-07</b>	<b>\$74.95</b>
Low	Round	Mini Medallion	Chrome	—	—	—	—	<b>52300022</b>	<b>\$99.95</b>
Low	Round	Mini Medallion	Gloss Black	—	—	—	—	<b>52300024</b>	<b>\$99.95</b>
Low	Square	Medallion	Chrome	<b>52655-84</b>	<b>\$89.95</b>	<b>52909-02</b>	<b>\$89.95</b>	<b>52754-04</b>	<b>\$99.95</b>
Low	Square	Medallion	Gloss Black	—	—	—	—	<b>51851-09</b>	<b>\$99.95</b>
Standard	Round	Mini Medallion	Chrome	—	—	—	—	<b>52300018</b>	<b>\$99.95</b>
Standard	Round	Mini Medallion	Gloss Black	—	—	—	—	<b>52300020</b>	<b>\$99.95</b>
Standard	Square	Medallion	Chrome	—	—	—	—	<b>52735-85</b>	<b>\$89.95</b>
Tall	Square	Medallion	Chrome	<b>52777-85A</b>	<b>\$99.95</b>	—	—	—	—



# 88 SPORTSTER®

Backrests & Racks



Typical H-D® Detachables™ Docking Hardware Kit

## Select the Docking Hardware

### Sportster Docking Hardware for H-D® Detachables™ Racks and Sideplates

Docking hardware fitment is dependent on vehicle model and saddlebag configuration.

<i>H-D Detachables Accessory</i>	<i>Available to fit:</i>	<b>Required Docking Hardware</b>	
Detachable Sideplates, Detachable Solo Rack 53494-04, 53512-07 One-Piece Detach Sissy Bar Upright 51146-10, 52300040 or Detachable Solo Tour-Pak® Rack 53655-04 with Leather Saddlebags 90330-08.	2004-later XL models (except XL883N, XL1200N, XL1200V and XL1200X)	<b>53544-04</b>	<b>\$44.95</b>
Detachable Sideplates, Detachable Solo Rack 53494-04, 53512-07 One-Piece Detach Sissy Bar Upright 51146-10, 52300040 or Detachable Solo Tour-Pak Rack 53655-04 with Leather Saddlebags 53050-10 and 88312-07A.	2004-later XL models	<b>53544-04</b>	<b>\$44.95</b>
Detachable Sideplates, Detachable Solo Rack 53494-04, 53512-07 One-Piece Detach Sissy Bar Upright 51146-10 without Leather Saddlebags.	2004-later XL models	<b>53529-04</b>	<b>\$44.95</b>
Detachable Sideplates or Detachable Solo Rack 53494-04, 53512-07 One-Piece Detach Sissy Bar Upright 51146-10 or Solo Tour-Pak Mounting Rack 53655-04 with Hard Saddlebags 91412-0XXX. Hard Saddlebags also require purchase of Hardware Kit 91405-04.	2004-later XL models (except XL883N, XL1200N, XL1200V and XL1200X)	<b>53529-04</b>	<b>\$44.95</b>
Detachable Sideplates 53545-95, 53609-01 or Detachable Solo Rack 53495-95 with Leather Saddlebags 90598-04, 90342-04A or 90330-08.	1994-2001 XL models	<b>90465-98A</b>	<b>\$69.95</b>
	2002-2003 XL (except XL Sport)	<b>53532-02</b>	<b>\$69.95</b>
Detachable Sideplates 53545-95, 53609-01 or Detachable Solo Rack 53495-95 without Leather Saddlebags.	1994-2003 XL models	<b>53528-95B</b>	<b>\$44.95</b>

### A. ONE-PIECE H-D® DETACHABLES™ SISSY BAR UPRIGHT

The sweeping shape of this slim, round bar Sissy Bar Upright completes the classic "bobber" look. The one-piece design eliminates separate sideplates for a clean appearance and the stylized upper kick angle mimics the old-school sissy bars of the '50s and '60s. Available in your choice of chrome or gloss black finish, these bars can be equipped with Passenger Backrest Pad P/N 52631-07.

Fits '04-later XL models. All models (except XL1200T) require separate purchase of appropriate Docking Hardware Kit.

<b>51146-10</b>	Gloss Black.	<b>\$199.95</b>
<b>52300040</b>	Chrome.	<b>\$209.95</b>

#### Shown with:

#### PASSENGER BACKREST PAD

Styled to complement available touring and custom seats.

Fits models equipped with One Piece H-D® Detachables™ Sissy Bar Upright P/N 52729-08, 51853-07, 51849-07, 51146-10, 51161-10, 52300040, 52300042, 52300044 or 52300046.

<b>52631-07</b>	Smooth Black.	<b>\$69.95</b>
-----------------	---------------	----------------



A. ONE-PIECE H-D DETACHABLES SISSY BAR UPRIGHT – GLOSS BLACK (SHOWN WITH PASSENGER BACKREST PAD)



A. ONE-PIECE H-D DETACHABLES SISSY BAR UPRIGHT – CHROME (SHOWN WITH PASSENGER BACKREST PAD)

Notice: The prices appearing in this catalog are the manufacturer's suggested retail prices. Actual retail prices may vary.



B. LOCKING H-D DETACHABLES LATCH KIT – CHROME

**B. LOCKING H-D® DETACHABLES™ LATCH KIT**

This unique lock replaces the camlock on your Harley-Davidson® Detachables™ accessories, providing additional security and peace of mind when parking your vehicle. The kit includes two extended-reach barrel-style keys for easy access to the lock. Key registration and replacement service is available. Sold in pairs.

Fits all models equipped with detachable Sideplates, Racks and Tour-Pak® Luggage Carriers (except '09-later Touring models equipped with detachable Solo Tour-Pak Rack).

**90300087** Chrome. **\$79.95**

**90300086** Black. **\$69.95**

**C. H-D DETACHABLES LATCH KIT – CHROME**

Decorative chrome latches are the perfect way to enhance the appearance of your detachable accessories. Meticulously polished and chrome-plated, these easy-to-install Rotary Latches are a direct replacement for the Original Equipment satin black parts and are a simple way to add a finishing touch to your ride. Latches feature an easy-to-pull finger release to simplify access in hard-to-reach areas.

**12600036** **\$49.95**

Fits all models equipped with detachable Sideplates, One-Piece Sissy Bar Uprights, Racks and Tour-Pak Luggage Mounting Racks.



B. LOCKING H-D DETACHABLES LATCH KIT – BLACK



C. H-D DETACHABLES LATCH KIT – CHROME

**D. REAR DOCKING HARDWARE COVER KIT**

Disguise the rear docking hardware with these easy-to-install covers. The caps slide over the exposed docking points and are held in place by a strong magnetic pull. The caps are easy to remove when you wish to reinstall detachable accessories. Covers are available with brilliant chrome or durable gloss black finish to match your bike's attitude. Sold in pairs.

Fits many accessory docking hardware kits. Refer to the fitment matrix in this P&A Catalog page 573 or the Parts & Accessories section of [www.harley-davidson.com](http://www.harley-davidson.com) for details.

**48218-10** Short Chrome (pair). **\$34.95**

**48220-10** Large Chrome (pair). **\$34.95**

**48035-09** Small Chrome (pair). **\$34.95**

**48221-10** Short Black (pair). **\$34.95**

**48223-10** Large Black (pair). **\$34.95**

**48225-10** Small Black (pair). **\$34.95**



D. REAR DOCKING HARDWARE COVER KIT – BLACK



D. REAR DOCKING HARDWARE COVER KIT – CHROME

*Notice: The prices appearing in this catalog are the manufacturer's suggested retail prices. Actual retail prices may vary.*



# 90 SPORTSTER®

## Backrests & Racks

### PASSENGER BACKREST PADS

Choose from a wide variety of backrest pad sizes and shapes to match your comfort and style demands. Designed to complement Original Equipment and accessory seats, these pads are engineered to fit specific sissy bar upright types.

#### A. SHORT BACKREST PAD

Innovative Backrest Pad mounting system features a brushed stainless steel insert framed with chrome plate and hardware.

**52517-94** **\$59.95**  
Fits Short Insert Style Sissy Bar Upright P/N 51513-02, 52737-94A or 52706-07.



**A. SHORT BACKREST PAD**

#### B. BACKREST PADS

Sized to fit medallion and mini medallion-style sissy bar uprights. Pad mounts with single center screw and bolt-on mounting strap. Includes chrome-plated hardware.

Fits Low Medallion Style Sissy Bar Upright P/N 52754-04 or 51851-09, Low Square Bar Mini-Medallion Style Sissy Bar Upright P/N 53282-06, Standard Square Bar Mini Medallion Style Sissy Bar Upright P/N 53281-06 or 53407-06, Standard Medallion Style Sissy Bar Upright P/N 52735-85, 53007-98, 52655-84, 52909-02 or 51517-02, Standard Bar & Shield Style Sissy Bar Upright 52739-83 or 51514-02, Standard Heritage Style Sissy Bar Upright P/N 52731-00 and Low Round Bar Sissy Bar Upright P/N 52300022 or 52300024.

**1. 52652-04** Smooth. **\$69.95**  
**2. 52626-04** Smooth Top-Stitched. **\$69.95**



**B. BACKREST PADS**

#### C. BACKREST PADS

Sized to fit round bar sissy bar uprights, these pads mount to mini medallion-style uprights with two mounting holes.

Fits Standard Round Bar Mini-Medallion Style Upright P/N 52877-10 or 51168-10. Also fits Low Round Bar Mini Medallion Style Sissy Bar Upright P/N 52540-09A, 51477-06, 54256-10, 52300049 and 52300050.

**1. 51641-06** Smooth Top-Stitched. **\$69.95**  
**2. 51640-06** Smooth Bucket. **\$99.95**  
**3. 51622-07** Fat Boy® Lacing Bucket. **\$119.95**  
**4. 52300301** CVO™ FXSBSE Style – Black. **\$129.95**  
**5. 52300293** CVO FXSBSE Style – Brown. **\$129.95**  
**6. 52300336** '14 CVO FXSBSE Style. **\$129.95**

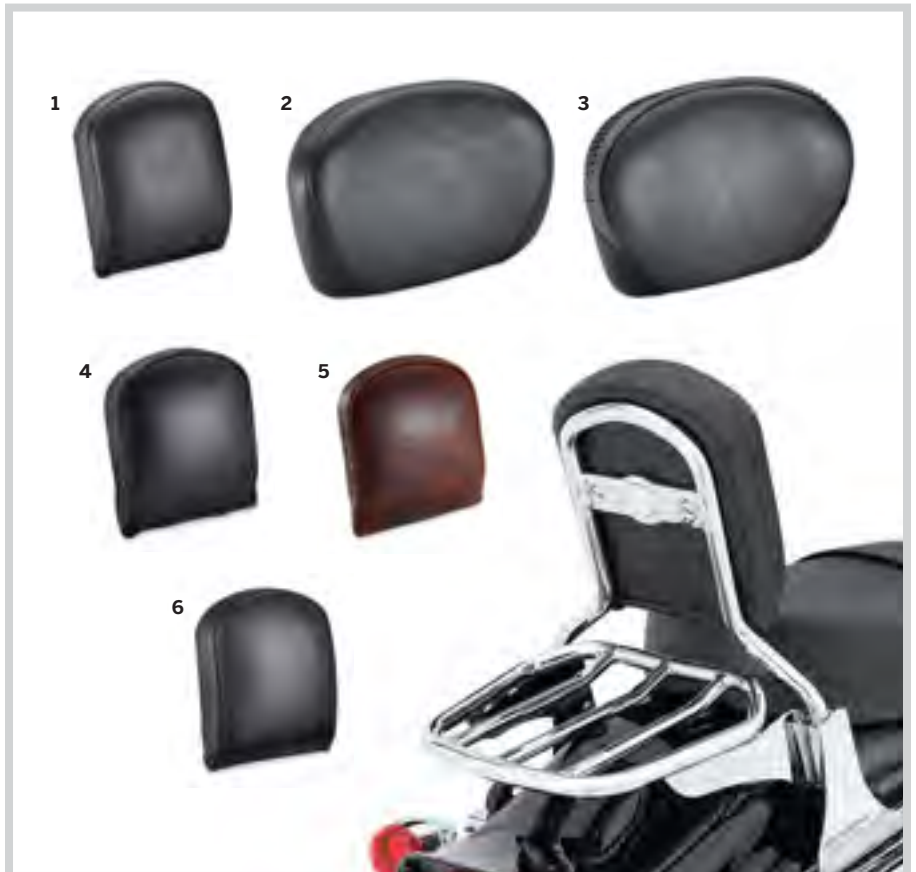

**C. BACKREST PADS**

*Notice: The prices appearing in this catalog are the manufacturer's suggested retail prices. Actual retail prices may vary.*



D. BACKREST PADS



E. BACKREST PADS

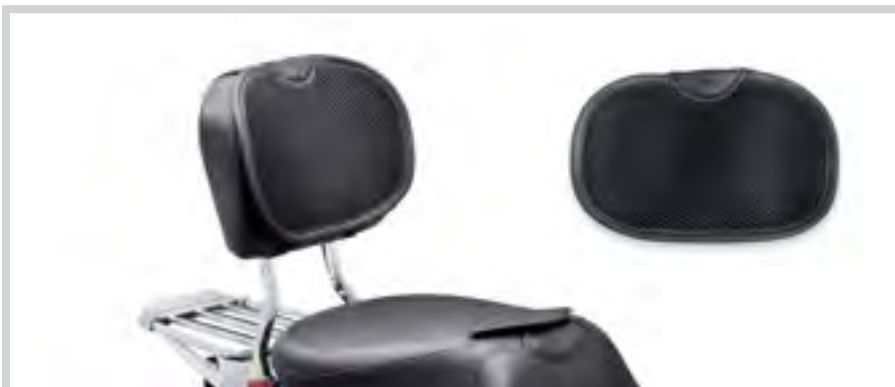

F. CIRCULATOR BACKREST PAD

**D. BACKREST PADS**

Sized to fit medallion and mini medallion-style sissy bar uprights. Pad mounts with single center screw and bolt-on mounting strap. Kit includes chrome-plated mounting hardware.

Fits Low Medallion Style Sissy Bar Upright P/N 52655-84, 52909-02, 52754-04, 51851-09, Standard Medallion Style Sissy Bar Upright P/N 52735-85 or 52877-08, Standard Square Bar Mini Medallion Style Sissy Bar Upright P/N 53281-06 or 53407-06, Standard Heritage Style Sissy Bar Upright P/N 52731-00 and Standard Round Bar Sissy Bar Upright P/N 52300018 or 52300020.

1. 52612-95	Smooth Top-Stitched.	\$69.95
2. 52412-79A	Embossed Bar & Shield Logo.	\$69.95
3. 52532-90	Fat Boy.®	\$79.95
4. 52348-97	Heritage Classic Bucket.	\$109.95
5. 52347-97	Fat Boy Bucket.	\$99.95
6. 51132-98	Smooth Bucket.	\$99.95

**E. BACKREST PADS**

Sized to fit tall medallion and insert-style sissy bar uprights. Pads mount with upper bolt-on mounting strap and two lower mounting clips. Kit includes chrome-plated mounting brackets and hardware.

Fits Tall Medallion Style Sissy Bar Upright P/N 52777-85A, 51519-02 or 52749-85A. Also fits Tall Insert Style Sissy Bar Upright P/N 51518-02 or 53552-81A.

52965-98	Smooth Top-Stitched.	\$79.95
----------	----------------------	---------

**F. CIRCULATOR BACKREST PAD**

Keep comfortable on your next long ride. These breathable Circulator Pads feature 3-D construction that promotes air movement and reduces heat build-up where the rider's body touches the backrest. Designed to keep the rider cool by reducing the perspiration build-up between you and the seating surface, the Circulator Pad can be installed and removed in seconds for easy cleaning. Manufactured of UV-stable materials, these seat pads resist fading when exposed to the sun.

52300103	Wide Backrest Pad.	\$59.95
----------	--------------------	---------

Fits wide profile rider and passenger backrest pads up to 12.0" wide and 9.0" tall.



## 92 SPORTSTER®

### Backrests & Racks

#### A. AIR FOIL PREMIUM LUGGAGE RACK\*

The low-profile aerodynamic styling defines the look of this Luggage Rack. Available in mirror-chrome or rich gloss black finish, the die-cast rear "Air Foil" grabs your attention and the Bar & Shield insert adds a signature touch. The elegant round tube rack features inlaid rubber runners for added grip and dedicated bungee mounting points to simplify luggage tie-down. Kit includes all necessary mounting hardware. For added visibility, the rack is designed to incorporate the internal wiring of the Air Foil Rack LED Light Kit P/N 68000076 (red) or 68000077 (smoked) for a clean look.

Fits '04-later XL models equipped with H-D® Detachables™ Sideplates, '06-later Dyna® models (except FXDF, FXDFSE/2 and '10-later FXDWG) equipped with Rigid or Detachable Sideplates, '84-'05 Softail® models (except FXSTD and FLSTN) and '06-later FLST, FLSTC, FLSTNSE and FLSTSC models and '06 FLSTF models equipped with Detachable or Rigid Mount Sideplates.

<b>54290-11</b>	Chrome.	<b>\$209.95</b>
<b>54291-11</b>	Gloss Black.	<b>\$209.95</b>

#### B. LED LIGHT KIT

Custom fit to the Air Foil Luggage Rack, this fast-acting LED Light Kit operates as a supplemental rear running light and brake light. The high, center-mount position places the light in the line-of-sight of following vehicles and the bright, fast-acting LED lamps get you noticed. Wiring is concealed inside the rack tubes for a clean, custom installation. Available with red or smoked lens.

Fits Air Foil Luggage Rack P/N 54290-11, 54291-11 and Air Wing Sissy Bar Upright P/N 52300146 and 52300147. Installation requires separate purchase of model-specific Wiring Harness Kit.

<b>68000076</b>	Red Lens.	<b>\$44.95</b>
<b>68000077</b>	Smoked Lens.	<b>\$44.95</b>

#### Also available:

#### LED LIGHT KIT WIRING HARNESS

Required for installation of LED Light Kit on Air Foil Luggage Rack P/N 54290-11 or 54291-11.

<b>70683-08</b>	<b>\$9.95</b>
-----------------	---------------

Fits '14-later XL models with Air Foil Luggage LED Light Kit P/N 68000076 or 68000077.

<b>69368-11</b>	<b>\$11.95</b>
-----------------	----------------

Fits '04-'13 XL models with Air Foil Luggage LED Light Kit P/N 68000076 or 68000077.

#### C. CUSTOM TAPERED SPORT LUGGAGE RACK\*

Smooth sweeping curves and the brilliant chrome or gloss black finish define the look of this Sport Luggage Rack. Designed to complement both round and square bar Sissy Bar Uprights, this sleek rack adds a practical and stylish touch to the motorcycle.

Fits '04-later XL models equipped with H-D Detachables Sideplates, '06-later Dyna models (except FXDF, FXDFSE/2 and '10-later FXDWG) equipped with Rigid or Detachable Sideplates, '84-'05 Softail models (except FXSTD and FLSTN) and '06-later FLST, FLSTC, FLSTNSE and FLSTSC models and '06 FLSTF models equipped with Detachable or Rigid Mount Sideplates.

<b>50300030</b>	Chrome.	<b>\$139.95</b>
<b>50300031</b>	Gloss Black.	<b>\$139.95</b>



A. AIR FOIL PREMIUM LUGGAGE RACK – CHROME



A. AIR FOIL PREMIUM LUGGAGE RACK – GLOSS BLACK



B. LED LIGHT KIT – RED LENS SHOWN



C. CUSTOM TAPERED SPORT LUGGAGE RACK – CHROME



C. CUSTOM TAPERED SPORT LUGGAGE RACK – GLOSS BLACK



**\*WARNING:** Do not use this rack as a seat. Do not exceed the fender rack weight capacity. Using as seat or exceeding this capacity could cause handling problems which could result in loss of control and death or serious injury.

Notice: The prices appearing in this catalog are the manufacturer's suggested retail prices. Actual retail prices may vary.



D. TAPERED LUGGAGE RACK – CHROME



D. TAPERED LUGGAGE RACK – GLOSS BLACK



E. SPORT LUGGAGE RACK – FOUR BAR



F. SPORT LUGGAGE RACK – FIVE BAR

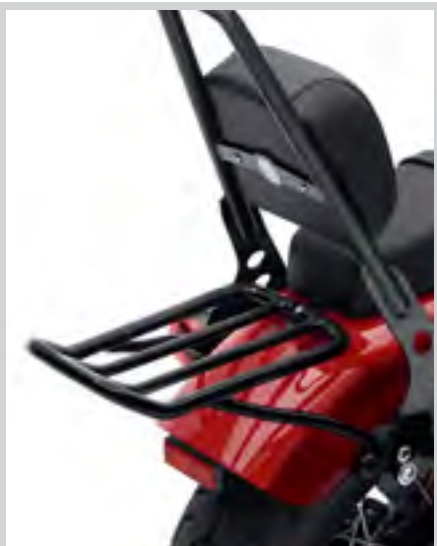

G. CHOPPED FENDER LUGGAGE RACK – GLOSS BLACK

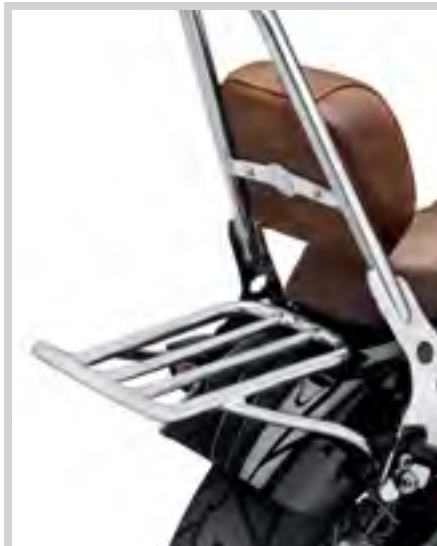

G. CHOPPED FENDER LUGGAGE RACK – CHROME

**D. TAPERED LUGGAGE RACK\***

Styled to enhance the lines of the motorcycle, this sleek, compact Tapered Rack is an elegant solution for carrying your lunch to work or your luggage across the country.

Fits '04-later XL models equipped with H-D® Detachables™ Sideplates, '06-later Dyna® models (except FXDF, FXDFSE/2 and '10-later FXDWG) equipped with Rigid or Detachable Sideplates, '84-'05 Softail® models (except FXSTD and FLSTN) and '06-later FLST, FLSTC, FLSTNSE and FLSTSC models and '06 FLSTF models equipped with Detachable or Rigid Mount Sideplates.

<b>53718-04</b>	Chrome.	<b>\$119.95</b>
<b>53510-07</b>	Gloss Black.	<b>\$119.95</b>

**E. SPORT LUGGAGE RACK – FOUR BAR\***

This sleek rack complements the lines of your motorcycle. Can be used with H-D Detachables or Rigid Mount Sissy Bar Sideplates.

**53899-02** Chrome. **\$119.95**

Fits '04-later XL models equipped with Rigid Sideplates P/N 53925-04 and '02-'05 Dyna models equipped with Rigid Sideplates or Detachable Sideplates.

**53711-96A** Chrome. **\$119.95**

Fits '90-'03 XL models with H-D Detachables Sideplate Kit P/N 53545-95, '82-'03 XL models with Rigid Mount Sideplate Kit P/N 52806-94B or 52782-82B, '82-'94 FXR models with Rigid Mount Sideplate Kit P/N 52781-82B (except FXRS-CONV. and FXRT). Fits '96-'01 Dyna models (except FXDWG). All '96-'01 Dyna models equipped with Rigid Mount Sideplates require the separate purchase of Luggage Rack Adapter Kit P/N 53828-00. Also fits '99-'00 FXR models.

**F. SPORT LUGGAGE RACK – FIVE BAR\***

This rack brings touring flexibility to your motorcycle. Can be used with H-D Detachables or Rigid Mount Sissy Bar Sideplates.

**53862-00** Chrome. **\$139.95**

Fits '04-later XL models equipped with Detachable Sideplates, '06-later Dyna models (except FXDF, FXDFSE/2 and '10-later FXDWG) equipped with Rigid or Detachable Sideplates, '84-'05 Softail models (except FXSTD and FLSTN), '06-later FLST, FLSTC and FLSTSC models and '06 FLSTF models equipped with Detachable or Rigid Mount Sideplates. Does not fit with Round Bar Uprights P/N 52300018, 52300020, 52300022 and 52300024.

**G. CHOPPED FENDER LUGGAGE RACK\***

This Luggage Rack is the ideal option for your ride across town or across the state. Designed for the chopped rear fender, this simple rack adds practical luggage space without compromising style. Rear supports attach to the fender struts and the rack is secured to the passenger pillion mounting point on the rear fender. Available in your choice of chrome or gloss black finish, this rack is compatible with H-D Detachables Uprights and docking hardware.

Fits '09-later XL883N, '07-later XL1200N, XL1200V and XL1200X models.

**54250-10** Gloss Black. **\$144.95**

**50300040** Chrome. **\$144.95**



**\*WARNING:** Do not use this rack as a seat. Do not exceed the fender rack weight capacity. Using as seat or exceeding this capacity could cause handling problems which could result in loss of control and death or serious injury.

Notice: The prices appearing in this catalog are the manufacturer's suggested retail prices. Actual retail prices may vary.



## 94 SPORTSTER®

### Backrests & Racks

#### A. H-D® DETACHABLES™ SOLO RACK\*

Add touring capabilities to your solo seat Sportster® model in less than 60 seconds. This detachable Solo Rack fits over the fender when the passenger pillion is removed. The rack features brazed hand-polished tubing and the chrome-plated or gloss black finish adds a stylish flair. Requires Docking Hardware.

Fits '04-later XL models equipped with solo seat. All models (except XL1200T) require separate purchase of appropriate Docking Hardware.

**53494-04** Chrome. **\$179.95**

**53512-07** Gloss Black. **\$179.95**

#### B. XR1200™ LUGGAGE RACK\*

Add touring capabilities to your XR1200™ model. This curved black rack complements the sporting lines of the rear fender and the reinforced polymer and steel construction adds strength and durability. Rack features molded tie-down notches that easily accept cargo net or bungee cord hooks for secure loading.

**53920-08** **\$139.95**

Fits '08-'13 XR1200 and XR1200X™ models.

#### Shown with:

##### XR1200 PASSENGER BACKREST

Add comfort and support for your passenger. Black polymer and steel upright provides a solid mounting point for the form fitted black vinyl backrest pad. Easy to install, the upright bolts into position on Luggage Rack P/N 53920-08 (sold separately).

**53976-08** **\$149.95**

Fits '08-'13 XR1200 and XR1200X models. Installation requires separate purchase of Luggage Rack P/N 53920-08.

#### C. XR1200 BUNGEE BARS

Secure your soft luggage or spare helmet to the passenger pillion. Bungee Bars provide a solid anchor point for bungee cords or cargo net hooks and protect the fender finish from damage. Black powder-coated steel bars feature formed detents on each side. Kit includes left and right bars and all required mounting hardware.

**90363-08** **\$59.95**

Fits '08-'13 XR1200 and XR1200X models.

#### D. TANK BAG

Shaped to fit the contour of the fuel tank, this ballistic nylon UV- and weather resistant tank bag is your perfect traveling companion. The bag features a clear top pouch for at-a-glance viewing of maps and directions. The rigid body retains its shape – even when empty – and the full-length dual-zippered opening provides easy access. The interior features (2) zippered mesh pouches, (1) quick access nylon pouch and large center cavity for storage of larger items. The internal top pouch adds (3) additional storage slots and (3) pen/pencil holders. Headphone port lets you to “plug in” while keeping your device protected inside the bag. Tank Bag features integrated rain cover with reflective striping. Integrated magnets and soft bottom keep the bag secure to tank while preventing scratches to paint. Quick-release clips allow the bag to be removed for easy access to the fuel filler and the comfortable carrying handle makes transportation a breeze.

**93300040** **\$139.95**

Fits '04-later XL models.



A. H-D DETACHABLES SOLO RACK – CHROME

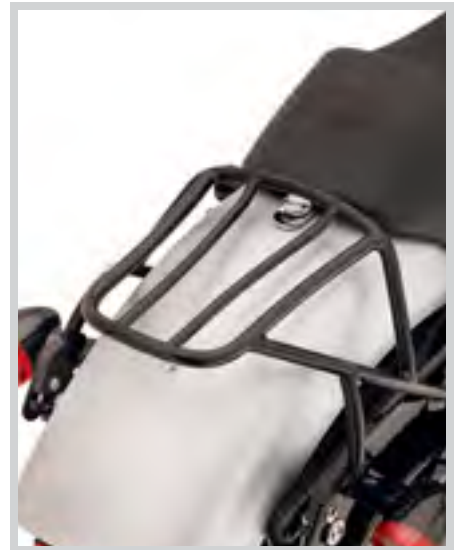

A. H-D DETACHABLE SOLO RACK – GLOSS BLACK



B. XR1200 PASSENGER BACKREST  
(SHOWN WITH XR1200 LUGGAGE RACK)



C. XR1200 BUNGEE BARS



D. TANK BAG



**\*WARNING:** Do not use this rack as a seat. Do not exceed the fender rack weight capacity. Using as seat or exceeding this capacity could cause handling problems which could result in loss of control and death or serious injury.

Notice: The prices appearing in this catalog are the manufacturer's suggested retail prices. Actual retail prices may vary.

**E. H-D® DETACHABLES™ LOCKING LEATHER SADDLEBAGS**

These large-capacity lockable detachable saddlebags are completely removable with the simple pull of the internal handle, leaving your bike clean and ready to cruise the boulevard. The handsome leather slant-style bags feature hidden quick-release clips behind the classic valise straps and black buckles. When removed, the large capacity bags leave behind two simple, inconspicuous docking points. The bags are compatible with both rigid and H-D® Detachables™ accessories when installed with the appropriate docking hardware kits. Luggage capacity: 2400 cubic inches total.

**88358-10** **\$879.95**

Fits '04-later XL models (except XL1200T and XL1200V). Models not equipped with Passenger Pegs require separate purchase of Passenger Footpeg Kit P/N 50203-04 ('04-'13 models) or P/N 50500270 ('14-later models). Domestic XL883N, XL1200N and XL1200X models require License Plate/Directional Relocation Kit P/N 73279-10. International (non-Canadian) XL883N, XL1200N or XL1200X models require Directional Relocation Kit P/N 67800075. '11-later XL1200C models require Directional Relocation Kit P/N 67800071 (Domestic) or 67800077 (International). All other models require separate purchase of Turn Signal Relocation Kit P/N 68732-02A (Domestic), 68733-02A (International) or Layback License Plate Kit P/N 60215-06. Models equipped with Saddlebags only or with Rigid Sideplates require separate purchase of Docking Hardware Kit P/N 53529-04. Models equipped with detachable accessories require separate purchase of Docking Hardware Kit P/N 53529-04 (if not already equipped) and 88390-10. Does not fit with Rear Axle Covers or Bobtail Fender.

**Also available:****DOCKING HARDWARE KIT**

Required when installing H-D Detachables accessories with H-D Detachables Saddlebag P/N 88358-10.

**88390-10** **\$49.95**

Fits '04-later XL models (except XL1200T and XL1200V).

**Also available:****LICENSE PLATE/DIRECTIONAL RELOCATION KIT**

Required when installing certain XL Saddlebags on models originally equipped with side-mount license plate.

**73279-10** **\$209.95**

Fits '07-later XL883N, XL1200N, XL1200V and XL1200X models with side-mounted license plate and equipped with XL Saddlebag Kit P/N 53050-10, 88358-10 or 90342-04A.

**Also available:****DIRECTIONAL RELOCATION KIT**

Kit moves turn signals from rear fender struts to a license bracket-mounted turn signal bar. Required for installation of fixed mount or detachable saddlebags on XL1200C models.

**67800071** Domestic. **\$99.95**

Fits '11-later XL1200C Domestic models.



**E. H-D DETACHABLES LOCKING LEATHER SADDLEBAGS – INSTALLED**



**E. H-D DETACHABLES LOCKING LEATHER SADDLEBAGS – REMOVED**



## 96 SPORTSTER®

### Saddlebags & Luggage

#### A. RIGID LEATHER LOCKING SADDLEBAGS

These premium textured leather saddlebags are ready to go the distance. The push-button latching swing-out lid is easy to operate with one hand and the fine leather surface and brushed chrome medallion add an elegant touch. The hard-shell design retains its shape in all kinds of weather and is covered in leather for a traditional look. Locking hinged lids offer modern convenience and security. Styled to complement the sleek, narrow Sportster® profile, these bags offer plenty of storage for a trip across town or across the country. Kit includes reflectors. Luggage Capacity: 2400 cubic inches total.

**53050-10** **\$729.95**

Fits '04-later XL models (except XL1200T, XL1200V and International (non-Canadian) XL883N, XL1200N or XL1200X models). Domestic XL883N, XL1200N and XL1200X models require License Plate/Directional Relocation Kit P/N 73279-10. '11-later XL1200C models require Directional Relocation Kit P/N 67800071 (Domestic) or 67800077 (International). All other models require separate purchase of Turn Signal Relocation Kit P/N 68732-02A (Domestic), 68733-02A (International) or Layback License Plate Kit P/N 60215-06. Models equipped with H-D® Detachables™ accessories require separate purchase of Docking Hardware Kit P/N 53544-04. Does not fit with Rear Axle Covers or Bobtail Fender.



A. RIGID LEATHER LOCKING SADDLEBAGS

#### B. SPORTSTER® LEATHER SADDLEBAGS

These saddlebags are constructed from 9 oz. leather with thermoformed backs for added shape retention. Bags feature an embossed "Sportster" script logo for style and quick-disconnect clips under traditional chrome buckles for easy access. Luggage capacity: 3000 cubic inches total.

**90342-04A** **\$659.95**

Fits '94-later XL models (except '02-'03 XL883R, XL1200S, XL1200T and models equipped with Rear Axle Covers, Flat Lens Turn Signals, accessory Bullet Style Turn Signals P/N 68005-99 and 68637-99 or '04-later models equipped with Bobtail fender or detachable sideplates). '04-later models (except XL883N, XL1200N, XL1200V and XL1200X models with side-mounted license plates) require separate purchase of Directional Relocation Kit P/N 68474-04B (chrome) or 73281-10 (black). XL883N, XL1200N, XL1200V and XL1200X models with side-mounted license plates require separate purchase of License Plate/Directional Relocation Kit P/N 73279-10. International (non-Canadian) XL883N, XL1200N, XL1200V and XL1200X models require separate purchase of Directional Relocation Kit P/N 67800075. '11-later XL1200C models require purchase of Turn Signal Relocation Kit P/N 67800071 (Domestic) or 67800077 (International). '94-'03 models require separate purchase of Directional Relocation Kit P/N 68485-04. '94-'03 models equipped with H-D Detachables accessories require separate purchase of Docking Hardware Kit P/N 90465-98A or 53532-02.



B. SPORTSTER LEATHER SADDLEBAGS

#### C. SYNTHETIC LEATHER SADDLEBAGS

Combine street attitude with long-haul versatility and you get these custom bags. Styled with sweeping lines to complement the Sportster fender, these bags feature plenty of storage space for a ride to the store or to Sturgis. The rigid plastic tub, wrapped in rich synthetic leather, offers long-term durability. The traditional straps hide quick-disconnect closures for packing convenience and the chrome buckles provide a look that's pure Harley-Davidson. Luggage capacity: 2000 cubic inches total.

**90330-08** **\$429.95**

Fits '04-later XL models (except XL883N, XL1200N, XL1200T, XL1200V, XL1200X, '02-'03 XL883R, models equipped with Rear Axle Nut covers or Flat Lens Turn Signals and models equipped with 2-into-1 exhaust). '04-later models require separate purchase of Turn Signal Relocation Kit P/N 68732-02A (Domestic), P/N 68733-02A (International) or Layback License Plate Kit P/N 60215-06. '11-later XL1200C fitment requires purchase of Turn Signal Relocation Kit P/N 67800071 (Domestic) or 67800077 (International).



C. SYNTHETIC LEATHER SADDLEBAGS

*Notice: The prices appearing in this catalog are the manufacturer's suggested retail prices. Actual retail prices may vary.*



D. "EXPRESS RIDER" LARGE CAPACITY LEATHER SADDLEBAGS

**D. "EXPRESS RIDER" LARGE CAPACITY LEATHER SADDLEBAGS**

Traditional "pony express" throw-over bag styling is enhanced with a modern rigid mounting structure on this handsome set of leather saddlebags. This Large Capacity Sportster® saddlebag offers the convenience of quick-release clips under conventional buckles for easy access. The riveted leather patch with embossed Bar & Shield logo completes the ageless look. Luggage capacity: 2400 cubic inches total.

**88312-07A** **\$529.95**

Fits '04-later XL models (except XL1200T, XL1200V and International (non-Canadian) XL883N, XL1200N or XL1200X models). Domestic XL883N, XL1200N and XL1200X models require License Plate/Directional Relocation Kit P/N 73279-10. '11-later XL1200C models require Directional Relocation Kit P/N 67800071 (Domestic) or 67800077 (International). All other models require separate purchase of Turn Signal Relocation Kit P/N 68732-02A (Domestic), 68733-02A (International) or Layback License Plate Kit P/N 60215-06. Models equipped with Detachable accessories require separate purchase of Docking Hardware Kit P/N 53544-04 (if not already equipped). Does not fit with Rear Axle Covers or Bobtail Fender.

**E. LEATHER THROW-OVER SADDLEBAGS**

These traditional Leather Throw-Over bags feature large side gussets for increased capacity and full-length straps with hidden quick-disconnect clips for easy access.

**91008-82C** **\$369.95**

Fits '82-later XL (except XL1200T), '08-later Dyna® (except FLD) and '84-'99 Softail® models equipped with H-D® Chrome Saddlebag Supports.

**F. SYNTHETIC LEATHER THROW-OVER ADJUSTABLE SADDLEBAGS**

Synthetic leather with embossed "Eagle Wing" logo. 11.0" H x 10.0" W x 3.75" D.

**90570-86TA** **\$119.95**

Fits '82-'03 XL, '91-'05 Dyna and '84-'99 Softail models equipped with Saddlebag Supports.

**G. CHROME SADDLEBAG SUPPORTS**

Fit with or without Sissy Bar Uprights, attach easily and protect bags from contacting brake and swingarm.

**90799-94D** **\$99.95**

Fits '94-later XL models (except XL1200S, XL1200T and '02-'03 XL883R). Does not fit with H-D® Detachables™. (Includes Chrome Upper Shock Covers P/N 54711-94.)



E. LEATHER THROW-OVER SADDLEBAGS



F. SYNTHETIC LEATHER THROW-OVER ADJUSTABLE SADDLEBAGS



G. CHROME SADDLEBAG SUPPORTS

*Notice: The prices appearing in this catalog are the manufacturer's suggested retail prices. Actual retail prices may vary.*



# 98 SPORTSTER®

## Saddlebags & Luggage

### A. HARD SADDLEBAGS\*

Sporty is the best way to describe any Sportster® model decked out with these lockable bags. These hard bags use injection-molded construction. Kit includes Turn Signal Relocation Hardware. Luggage capacity: 2,500 cubic inches total.

Fits '04-later XL models (except XL883N, XL1200N, XL1200T, XL1200V, XL1200X). Installation on vehicles equipped with H-D® Detachables™ Sissy Bar or Luggage Rack requires the separate purchase of Mounting Hardware Kit, '04-later models require Hardware Kit P/N 91405-04.

<b>91412-04BDK</b>	Primed.	<b>\$1,249.95</b>
<b>91412-04AV</b>	Birch White.	<b>\$1,499.95</b>
<b>91412-04DH</b>	Vivid Black.	<b>\$1,499.95</b>



A. HARD SADDLEBAGS

### B. SPORT TOUR-PAK® LUGGAGE\*

Designed to complement the styling of the Softail® and Sportster Hard Saddlebags, the Sport Tour-Pak® Luggage adds increased storage for your ride across town or across the country. The injection molded Tour-Pak Luggage is lockable and includes an interior rubber mat. Large enough to store most full-faced helmets. Racks and docking kits sold separately. International models may require separate purchase of License Plate Relocation Kit P/N 60095-00A. Luggage capacity: 2245 cubic inches.

Fits '04-later XL models (except XL883N, XL1200C and XL1200N) equipped with Solo Seat and Solo Tour-Pak® Rack. Fits '00-'05 Softail® models (except Deuce™) and '06 FLST, FLSTF, and '06-later FLSTC, FLSTN, FLSTSC models equipped with H-D Detachables Solo or Two-Up Tour-Pak Rack. Fits '97-'08 Touring models equipped with Detachable Two-Up or Solo Tour-Pak Racks.

<b>53929-12BDK</b>	Primed.	<b>\$569.95</b>
<b>53929-06AV</b>	Birch White.	<b>\$749.95</b>
<b>53929-06DH</b>	Vivid Black.	<b>\$749.95</b>

### C. BACKREST PAD FOR SPORT TOUR-PAK LUGGAGE

**52872-01** **\$104.95**  
Fits models equipped with Color-Matched Sport Tour-Pak Luggage.

### D. H-D® DETACHABLES™ SOLO TOUR-PAK MOUNTING RACK\*\*

The Solo Tour-Pak Rack places the Sport Tour-Pak in a comfortable back-supporting position. The rack is designed to position the Tour-Pak for solo riding. Simply remove the Tour-Pak Rack from the convenient docking hardware, add a passenger pillion and the bike is ready for two-up riding. Tour-Pak, Passenger Backrest Pad and Docking Hardware sold separately.

**53655-04** **\$139.95**  
Fits '04-later XL models equipped with solo seat (except XL883N, XL1200C, XL1200N). Designed to accept Color-Matched Sport Tour-Pak P/N 53929-YYXX, Leather Tour-Pak P/N 53151-00A, 53147-98B, 53018-04A or 53690-06A. Requires separate purchase of appropriate Docking Hardware.



B. SPORT TOUR-PAK LUGGAGE  
(SHOWN WITH H-D DETACHABLES SOLO TOUR-PAK RACK AND BACKREST PAD)



C. BACKREST PAD FOR  
SPORT TOUR-PAK LUGGAGE



D. H-D DETACHABLES SOLO TOUR-PAK  
MOUNTING RACK

\*NOTE: This product is a "Paint to Order" accessory. Please allow for an average of 5 weeks delivery for this item.



**\*\*WARNING:** Do not use this rack as a seat. Do not exceed the fender rack weight capacity. Using as seat or exceeding this capacity could cause handling problems which could result in loss of control and death or serious injury.

Notice: The prices appearing in this catalog are the manufacturer's suggested retail prices. Actual retail prices may vary.



**E. TOUR-PAK LUGGAGE**  
(SHOWN WITH H-D DETACHABLES SOLO TOUR-PAK MOUNTING RACK)

### E. TOUR-PAK® LUGGAGE

Add cross-country luggage capacity to your ride with accessory Tour-Pak® Luggage. A cavernous interior will hold one full face helmet or two half helmets. Kit includes backrest pad, interior rubber mat, hardware and instructions. Luggage capacity: 2500 cubic inches. Dimensions: 18.5" W x 17.0" D x 13.0" H. Racks and docking kits sold separately. International models may require separate purchase of License Plate Relocation Kit P/N 60095-00A.

**53690-06A** Smooth Vinyl. **\$514.95**

Fits '04-later XL models (except XL883N, XL1200C, XL1200N) equipped with Solo Tour-Pak® Rack. Fits '00-later Softail® models (except FLS, FLSTNSE, FLSTSE/2/3, FXCW, FXCWC, FXS, FXSB, FXSBSE, FXSTD, FXSTSSE3) equipped with H-D® Detachables™ Solo or Two-Up Tour-Pak Rack. Fits '97-'13 Touring models (except Trike) equipped with Detachable Two-Up or Solo Tour-Pak Racks.

### F. SINGLE-SIDED SWINGARM BAG

Less is more. With enough room for the essentials, these stylish Swingarm Bags eliminate the need to stuff your pockets or bungee a bag across the passenger pillion. Shaped to hug the contour of your bike's frame, these compact bags add an old-school look. Bags are constructed of heavyweight leather and feature a pouch-style flap lid that is secured with two quick-disconnect clips that are hidden behind traditional straps and buckles. The semirigid-backed bag is secured to the left side of the bike with easy-to-install brackets and adjustable straps. Luggage capacity: 430 cubic inches total.

Fits '04-later XL models equipped with solo seats. Requires removal of passenger pegs. XL1200T models require removal of Original Equipment saddlebags and passenger pegs.

**90200572** Black Leather. **\$199.95**

**90200573** Brown Distressed Leather. **\$199.95**

### G. DOWN-TUBE BAG

The perfect place to store a couple of tools, a tire gauge or your disc lock. The rigid-backed bag features a stylish heavy leather flap and traditional strap-and-buckle closures to provide both function and flair. Easy-to-install, the low frame placement is inconspicuous, but still provides quick access when needed. Kit includes all required mounting hardware.

Fits '04-later XL, XR and '06-later Dyna® models (except FLD). Does not fit XL models with engine guard. Does not fit XL models with Boom!™ Audio Cruiser Amp and Speaker Kit P/N 76262-08 or 76320-08. Does not fit Dyna models with evaporative emissions canister (California and AP markets). Does not fit with Dyna Oil Cooler Kit P/N 26151-07. Does not fit XL and Dyna models equipped with Front Spoilers. FXDSE/2 and FXDFSE/2 models require removal of Original Equipment front spoiler.

**93300044** Black Leather. **\$129.95**

**93300045** Brown Distressed Leather. **\$129.95**



**F. SINGLE-SIDED SWINGARM BAG – BLACK LEATHER**



**F. SINGLE-SIDED SWINGARM BAG – BROWN DISTRESSED LEATHER**



**G. DOWN-TUBE BAG – BLACK LEATHER**



**G. DOWN-TUBE BAG – BROWN DISTRESSED LEATHER**



# 100 SPORTSTER®

Saddlebags & Luggage

## A. UNIVERSAL SADDLEBAG LOCK KIT

Keep the contents of your existing soft-sided saddlebags safe from the grab-and-go thief. This unique kit features two extra-small barrel locks that can replace existing saddlebag snaps to perform double duty as locks or as snaps when you don't need to lock your bags. Can be keyed to match your barrel-style ignition key. Sold in pairs.

Fits most soft-sided leather and vinyl saddlebags. Does not fit FLHRC and FLHRS.

<b>90300003</b>	Keyed To Match.	<b>\$59.95</b>
<b>90300017</b>	Random Key Code.	<b>\$49.95</b>

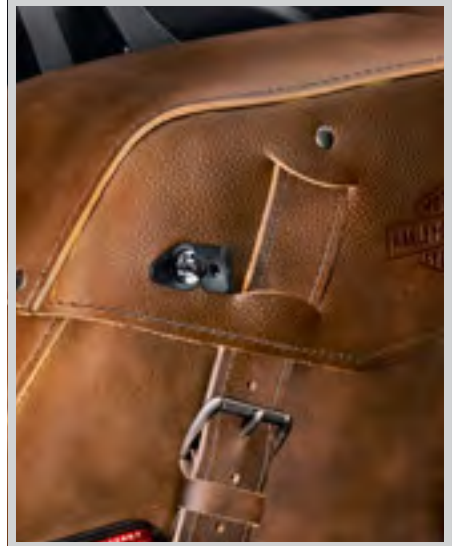

A. UNIVERSAL SADDLEBAG LOCK KIT

## B. SADDLEBAG TRAVEL-PAKS

Water-resistant liners make packing easy. Feature inner pockets for extra storage and an embroidered Bar & Shield logo.

<b>91959-97</b>	<b>\$54.95</b>
Liner dimensions: 12.0"W x 10.0"T x 5.0"D.	

<b>91486-01</b>	<b>\$49.95</b>
Fits XL models and Dyna® models equipped with Color-Matched Hard Saddlebags.	



B. SADDLEBAG TRAVEL-PAKS  
(91959-97 SHOWN)

## C. TANK BRA

This Tank Bra is made with non-abrasive, fleece-backed vinyl material and features an embroidered Bar & Shield logo. It protects your fuel tank from scratches from keys, belt buckle, etc. Designed for easy installation and a custom fit without disassembly of the tank or seat.

<b>62027-04</b>	<b>\$42.95</b>
Fits '04-later XL models equipped with 4.5 gallon fuel tank.	

<b>62030-04</b>	<b>\$44.95</b>
Fits '04-later XL models equipped with 3.3 gallon fuel tank.	

<b>61929-98</b>	<b>\$44.95</b>
Fits '97-'03 XL models equipped with 3.3 gallon fuel tanks.	



C. TANK BRA

## D. AUXILIARY POWER PORT – SADDLEBAG MOUNT

Charge your cell phone or portable music player from this handy saddlebag-mounted 12-volt power port. Conventional "cigarette lighter" style power outlet accepts most 12V automotive power adaptor plugs and features a flip-top cover to protect the port while not in use.

<b>69200091</b>	<b>\$40.95</b>
Fits models equipped with 12-volt battery. Does not fit VRSC™ models, Throw-Over or Swingarm Bags. Not for use with accessory Fitted Liners or Premier Liners. Requires separate purchase of Battery Charging Harness P/N 94624-97B, if not already equipped.	

## E. USB CHARGING ADAPTOR

Charge your cell phone, MP3 players and other hand-held devices while on the road. Compact Adaptor plugs into standard and accessory "cigarette lighter" 12-volt power ports and provides a standard USB-style outlet that accepts many phone and music player power cords.

<b>69200357</b>	<b>\$19.95</b>
For use with 12V Auxiliary Power Port.	



D. AUXILIARY POWER PORT –  
SADDLEBAG MOUNT



E. USB CHARGING ADAPTOR

Notice: The prices appearing in this catalog are the manufacturer's suggested retail prices. Actual retail prices may vary.

## A STRONG FOUNDATION

Being sure-footed at a stop or when parking your bike enhances your feeling of control and confidence. Adjusting the ride height by lowering the suspension may be the first step in fitting the bike to your inseam length. Combining a low-profile suspension and a narrow seat is the easiest way for a shorter rider to fit comfortably on a larger bike.

### SUSPENSION

While most current Sportster® models are already equipped with low-profile suspension, Harley® offers optional two-up shocks that maintain the low ride height and add additional carrying capacity. Or, if you are willing to exchange the low-profile "slammed" look for improved ride comfort, Comfort Flex standard-length shocks deliver an improved ride through a longer stroke.



### ESTABLISH YOUR POSITION



### HANDLEBARS

Where the bar positions your hands, wrists and arms directly affects how you feel on the motorcycle. The shape of the bar determines your reach to the hand controls and, therefore, your overall comfort.



### SEATS

The right seat is equal parts ergonomics and comfort. Its shape anchors your position and determines the reach to the ground and to the controls and the padding supports your tailbone and hips to relieve stress and pressure. Pick the right one for you – and your passenger.



### FOOT CONTROLS

Where your feet contact the controls can often determine how many miles you can put on in a day. Mid-controls position your feet below the knee for a sporting riding posture, while forward controls stretch your legs for a relaxed, laid-back posture.

THE FIT SHOP LIST	2015	SUSPENSION	SEATS	HANDLEBARS	FOOT SUPPORTS
 <p>Here are a few options to consider when outfitting your bike to fit you. Find your model and flip to the pages for more information. For more details, visit <a href="http://h-d.com/fitshop">h-d.com/fitshop</a>.</p>	XL883N	Low Suspension is Stock Two-Up Profile® Low Rear Shocks Comfort Flex Rear Shocks	Reduced Reach® Seats Brawler®/Sidekick® Seat Badlander® Seat Road Zeppelin® Seat	Mini-Ape Handlebar Drag Bar Chizeled Bar	Further Forward Mid-Controls Reduced Reach Forward Controls Forward Control Kit Adjustable Highway Pegs Adjustable Passenger Pegs
	XL883L XL1200T	Low Suspension is Stock Two-Up Profile Low Rear Shocks	Reduced Reach Seats Brawler/Sidekick Seats Badlander Seat Road Zeppelin Seat	Mini-Ape Handlebar Chizeled Bar Iron 883™ Handlebar	Further Forward Mid-Controls Reduced Reach Forward Controls Forward Control Kit Adjustable Highway Pegs Adjustable Passenger Pegs
	XL1200C	Low Suspension is Stock Two-Up Profile Low Rear Shocks Comfort Flex Rear Shocks	Reduced Reach Seats Brawler / Sidekick Seats Badlander Seat Road Zeppelin Seat	Reduced Reach Bar Iron 883 Handlebar	Further Forward Mid-Controls Reduced Reach Forward Controls Adjustable Passenger Pegs
	XL1200V	Low Suspension is Stock Two-Up Profile Low Rear Shocks Comfort Flex Rear Shocks	Reduced Reach Seats Brawler / Sidekick Seats Badlander Seat Road Zeppelin Seat	Mini-Ape Handlebar Drag Bar Chizeled Bar Iron 883 Handlebar	Further Forward Mid-Controls Reduced Reach Forward Controls Adjustable Passenger Pegs
	XL1200X	Low Suspension is Stock Two-Up Profile Low Rear Shocks Comfort Flex Rear Shocks	Reduced Reach Seats Brawler / Sidekick Seats Badlander Seat Road Zeppelin Seat	Mini-Ape Handlebar Chizeled Bar Hollywood Handlebar	Further Forward Mid-Controls Reduced Reach Forward Controls Adjustable Passenger Pegs



# 102 SPORTSTER®

## Suspension

### A. PROFILE® LOW FRONT SUSPENSION KIT\*

This kit is designed to lower the front suspension by approximately 1.0" while preserving the ride quality. The shorter fork springs are progressively wound to allow a compliant, controlled ride. A perfect addition during the installation of chrome or gloss black lower fork sliders, kit includes two fork springs and damper tubes.

**45500-09** **\$104.95**

Fits '09-'10 XL883, XL883C, XL883R, XL1200C and XL1200R models. '09-'10 XL883, XL883R and XL1200R models must also have Low Rear Shock Kit P/N 54754-09 installed.

**45480-05** **\$104.95**

Fits '04-'08 XL models (except '07-'08 XL883L and XL1200N). Stock on '04-'06 XL883L and '06-'08 XL1200L models. XL883, XL883R, and XL1200R models must also have Low Rear Shock Kit P/N 54750-05A, 54731-04, or 54733-04 installed.



**A. PROFILE LOW FRONT SUSPENSION KIT  
(P/N 45500-09 SHOWN)**



**A. PROFILE LOW FRONT SUSPENSION KIT  
(P/N 45480-05 SHOWN)**

### B. PROFILE LOW REAR SHOCK KIT\*

Plant your feet firmly on the ground. This reduced length version of the Original Equipment rear suspension lowers the seat height by approximately 1.0". Shocks feature chrome-plated springs and body caps, and suspension preload is adjustable for rider and passenger load.

**54754-09** **\$224.95**

Fits '06-'10 XL883, XL883R and XL1200R models. Stock on '09-'10 XL883C, '09-later XL1200C and XL1200L. Kit includes shorter jiffy stand.

**54733-04** **\$224.95**

Fits '91-'05 XL883, XL883DLX, XL883R and XL1200 models. Does not lower XL Custom, XL883L, XL1200L, XL 50th Anniversary or Hugger™ models.

### C. TWO-UP PROFILE LOW REAR SHOCK KIT\*

These heavy-duty shocks are tuned for the touring rider carrying a passenger or loaded saddlebags. Shock length and spring rate are engineered to maintain the factory low seat height. The chrome-bodied shocks feature adjustable preload for a comfortable, controlled ride.

**54704-07** **\$224.95**

Fits '07-later XL883L, XL883N, XL1200N, XL1200V, XL1200X and '11-later XL1200C models.



**B. PROFILE LOW REAR SHOCK KIT  
(P/N 54733-04 SHOWN)**



**C. TWO-UP PROFILE LOW REAR SHOCK KIT**

### D. SPORTSTER® COMFORT FLEX REAR SHOCKS\*

For the rider willing to exchange the low-profile "slammed" look for improved ride comfort. Standard-length shocks raise the seat height of a factory-lowered bike approximately 1.0" and deliver an improved ride through a longer stroke. Spring rates and damping are tailored to ensure a controlled ride and optimal performance under varying conditions. Kit includes left and right rear shock absorbers.

**54000040** **\$224.95**

Fits '11-later XL1200C, XL1200V, '08-later XL1200L, '07-later XL883N, XL883R, XL1200N, XL1200X, XL50, and '05-'10 XL883L models. Stock on International models of XL883N and XL1200N in HDI, ENG, AUS and APC markets. Cannot be used on models equipped with Profile® Low Front Suspension Kits.



**D. SPORTSTER COMFORT FLEX REAR SHOCKS**



**\*WARNING:** The Profile Low Front Spring Kit cannot be used independently and must be used with the appropriate Profile Rear Shock Lowering Kit. Installation of any accessory suspension components may affect cornering clearance and jiffy stand operation. This could distract the rider, causing loss of control and death or serious injury.



**\*WARNING:** Installation of any accessory suspension components may affect cornering clearance and jiffy stand operation. This could distract the rider, causing loss of control and death or serious injury.

*Notice: The prices appearing in this catalog are the manufacturer's suggested retail prices. Actual retail prices may vary.*

# SPORTSTER® 103

## Foot Controls



**E. ADJUSTABLE HIGHWAY PEG SUPPORT KIT**



### E. ADJUSTABLE HIGHWAY PEG SUPPORT KIT\*

So you're not your average Sportster® motorcycle rider. But then again, there is nothing average about Harley-Davidson. These chrome-plated Highway Peg Supports adjust easily and quickly into three height-accommodating positions. Use with your choice of H-D® small male mount-style footpegs (not included). Includes all necessary hardware.

**49053-04A** **\$199.95**

Fits '04-later XL models with mid controls.

### F. JIFFY STAND EXTENSION

Jiffy Stand Extension kits have been ergonomically designed to simplify the deployment and retraction of the jiffy stand. The extension is shaped to simplify locating the tab with your boot and aid in swinging the jiffy stand into position. The move feels natural and adds confidence when parking your motorcycle in a tight spot. Kit mounts to Original Equipment jiffy stand and includes all required mounting hardware.

**50462-11** Black. **\$34.95**

Fits '07-later XL and XR models (except XL50, XL883C, XL1200L, XL1200T, XL1200V, '09-'10 XL1200C, '07-'08 XL883, XL883R and XL1200R). Does not fit '09-later XL883N, XL1200X and XL1200N for International markets AUS, BRZ, ENG and HDI.

**50250-04** Chrome. **\$44.95**

Fits '04-later XL1200V, '04-'13 XL883C, XL1200L and '04-'10 XL1200C models. Also fits XL883N and XL1200N models for International markets AUS, BRZ, ENG, HDI and India.

### G. CUSTOM GEAR SHIFT LINKAGES

Kick your custom into gear with this collection of high-quality Custom Shift Linkages. Available in a variety of designs to match your bike's style, these linkages feature aircraft quality rod ends for easy adjustment and smooth operation. The easy-to-install linkage kit includes decorative bolts for a complete custom look.

Fits '04-later XL models equipped with standard forward controls.

**1. 34840-09** Skull. **\$109.95**

**2. 33778-09** Black Anodized Slotted Linkage. **\$99.95**

**3. 33900102** Silencer Brushed Nickel. **\$99.95**

### H. GEAR SHIFT LEVER – CHROME

Shift in style with this brilliant, chrome-plated shift lever. Complete the look with a custom shifter peg.

**34606-90T** **\$62.50**

Fits '91-'03 XL models (except models equipped with forward controls).



**F. JIFFY STAND EXTENSION – BLACK**



**F. JIFFY STAND EXTENSION – CHROME**



**G. CUSTOM GEAR SHIFT LINKAGES**



**H. GEAR SHIFT LEVER – CHROME**

SPORTSTER

*Notice: The prices appearing in this catalog are the manufacturer's suggested retail prices. Actual retail prices may vary.*



# 104 SPORTSTER®

## Foot Controls

### A. FORWARD CONTROL KIT\*

Add the stretched-out look and extended riding position to your Sportster® model. The complete kit includes all hardware necessary to convert your Sportster model from mid-controls to forward controls. Available in your choice of finishes, these forward controls add style and long range comfort. (Footpegs and shifter peg not included.)

Fits '14-later XL models. Requires separate purchase of stock or accessory rider position footpegs with wear pegs that fit '14-later XL1200 models.

**50700020** Chrome. **\$469.95**

**50700021** Black. **\$399.95**

Fits '06-'13 XL models with mid-controls. XL1200L requires separate purchase of footpegs P/N 33134-07CAZ and 33135-07CAZ.

**33395-06A** Chrome. **\$449.95**

**33398-06A** Polished. **\$399.95**

**33397-07A** Black. **\$399.95**

Fits '04-'05 XL models. Does not fit with 2-into-1 Exhaust Systems.

**33395-04** Chrome. **\$449.95**

**33398-04** Polished. **\$399.95**

Fits '91-'03 XL (except XL883R). Does not fit with 2-into-1 Exhaust Systems. Current owners of Engine Guard P/N 49018-88A and 49018-88B will need to purchase bracket P/N 49014-86A for proper fitment (sold separately). This kit will not fit on vehicles equipped with an early style engine guard. Use Engine Guard Kit P/N 49018-88C when adjustable highway peg supports are installed.

**33891-98** Chrome. **\$499.95**

**33892-98** Polished. **\$399.95**

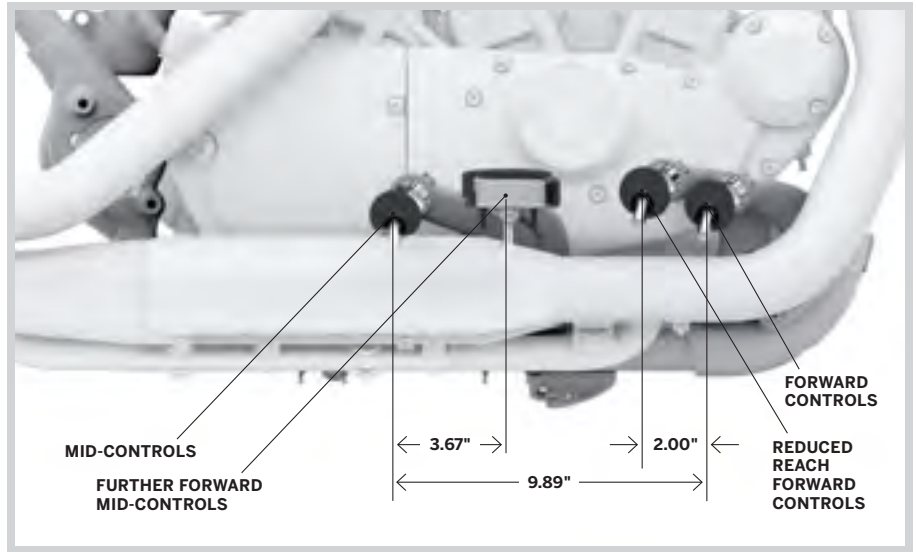

FOOT CONTROL POSITION COMPARISON



A. FORWARD CONTROL KIT – CHROME



A. FORWARD CONTROL KIT – BLACK



**\*WARNING:** Installation of accessory Forward Control Kits may affect cornering clearance. This could distract the rider, causing loss of control, resulting in death or serious injury.

Notice: The prices appearing in this catalog are the manufacturer's suggested retail prices. Actual retail prices may vary.

# SPORTSTER® 105

Foot Controls



NEW



NEW

## B. REDUCED REACH FORWARD CONTROL CONVERSION KIT (50700026 SHOWN)

### B. REDUCED REACH FORWARD CONTROL CONVERSION KIT\*

Love the look and riding position you get with forward controls but not comfortable with the long stretch forward? This Forward Control Conversion Kit repositions the Original Equipment footpegs and foot controls up and back by 2.0" and positions the controls closer to the rider for added comfort and confidence. This kit provides additional leg clearance around the chassis and air cleaner by moving the footpegs outward 1.5" (left) and 0.5" (right). The reduced reach places the rider's boot at the proper pivot point for improved leverage, while maintaining the "foot-forward" riding profile. This easy-to-install Conversion Kit includes heavy-duty steel mounts and shortened brake rod and reuses Original Equipment control supports and brake and shift levers or can be personalized with your choice of custom lever styles.

**50700010** **\$179.95**

Fits '04-'13 XL models equipped with forward controls.

**50700026** **\$249.95**

Fits '14-later XL models equipped with forward foot controls.

### C. FURTHER FORWARD MID-CONTROL KIT

Feel a little cramped when your feet are placed on the standard-location mid-controls? This kit repositions the controls 3.0" forward of the stock location, eliminating the "knees-high" riding attitude while maintaining a sporty upright riding posture. The forward location provides an open path for your feet to aid maneuvering the bike while parking and improves access to the jiffy stand for a shorter rider. Kit includes control mounts, brake and shift levers, brake rod, mini-footboards with wear pegs and all hardware necessary to convert your mid- or forward-control equipped Sportster® model.

Fits '14-later XL models.

**50700027** Chrome. **\$469.95**

**50700028** Gloss Black. **\$399.95**



NEW



NEW

## C. FURTHER FORWARD MID-CONTROL KIT – CHROME



NEW



NEW

## C. FURTHER FORWARD MID-CONTROL KIT – GLOSS BLACK



**\*WARNING:** Installation of accessory Forward Control Kits may affect cornering clearance. This could distract the rider, causing loss of control, resulting in death or serious injury.

Notice: The prices appearing in this catalog are the manufacturer's suggested retail prices. Actual retail prices may vary.

SPORTSTER



# 106 SPORTSTER®

## Engine Guards

### A. ENGINE GUARD\*

The unique soft curve shape adds style to function. The one-piece Engine Guard is designed to complement the lines of the Sportster® motorcycle and the choice of finishes adds the perfect finishing touch. Add your choice of Engine Guard Mounted Highway Pegs (sold separately) to change your foot position on a long ride.

Fits '04-later XL and XR models (except XL1200T and '11-later XL883L). (Will not fit with Front Spoilers.)

**49060-04** Chrome. **\$214.95**

**49215-07** Gloss Black. **\$214.95**

Fits '11-later XL883L and '14-later XL1200T models. (Will not fit with Front Spoilers.)

**49287-11** Chrome. **\$214.95**

### B. SOFT LOWERS

Extend your riding season. Full coverage Soft Lower provide wind and mud protection for the rider's legs and boots and minimize cold updrafts as the weather changes. Covers are custom shaped to hug the engine guard to minimize flapping and they clip in place for speedy installation as the weather changes. Two-way zippered outer edge accommodates guard-mounted highway pegs in almost any position. Reflective piping provides added visibility and convenient zippered pockets provide additional storage for maps or other small items.

**57100211** **\$89.95**

Fits '04-later XL models (except '11-later XL883L and '14-later XL1200T) equipped with Engine Guard P/N 49060-04 or 49215-07. Does not fit Mustache Engine Guards.



A. ENGINE GUARD – CHROME



A. ENGINE GUARD – GLOSS BLACK



B. SOFT LOWERS



B. SOFT LOWERS



**\*WARNING:** Engine guards may provide limited leg and cosmetic vehicle protection under unique circumstances (fall over while stopped, very low speed slide). They are not made nor intended to provide protection from bodily injury in a collision with another vehicle or any other object.

Notice: The prices appearing in this catalog are the manufacturer's suggested retail prices. Actual retail prices may vary.

# SPORTSTER® 107

## Engine Guards

### C. MUSTACHE ENGINE GUARD\*

Combine classic shape and modern function for a unique twist on engine protection. The flow of this Engine Guard complements the bike's traditional style while the gracefully curved upper section incorporates highway pegs into the shape. The integrated rubber pads offer a comfortable and slip-resistant cushion for your feet while traveling the open road. One-piece engine guard kit includes all required mounting hardware.

Fits '04-later XL and XR models. (Will not fit with Front Spoilers.)

<b>49000005</b>	Chrome.	<b>\$269.95</b>
<b>49000006</b>	Gloss Black.	<b>\$269.95</b>

### D. ENGINE GUARD\*

This highly-polished, chrome-plated guard matches stock plating and works great with the Sportster® Forward Controls.

**49018-88C** Chrome. **\$219.95**

Fits '84 1/2-'03 XL models. (Will not fit with Front Spoilers.)

(NOTE: '82-early '84 models require Bracket P/N 49014-85.)



C. MUSTACHE ENGINE GUARD – CHROME



C. MUSTACHE ENGINE GUARD – BLACK

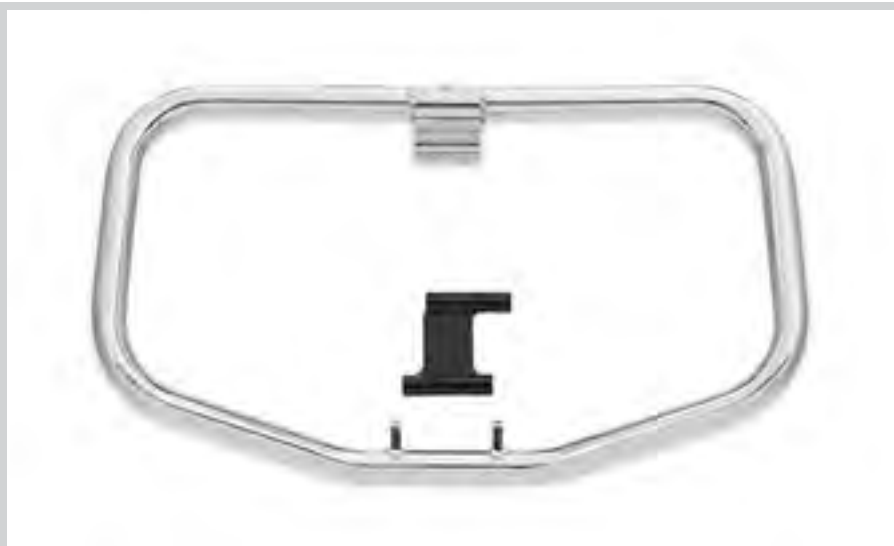

D. ENGINE GUARD – CHROME



**\*WARNING:** Engine guards may provide limited leg and cosmetic vehicle protection under unique circumstances (fall over while stopped, very low speed slide). They are not made nor intended to provide protection from bodily injury in a collision with another vehicle or any other object.



**\*WARNING:** Do not use engine guard footpegs under normal stop and go operating conditions. Doing so could result in death or serious injury.

Notice: The prices appearing in this catalog are the manufacturer's suggested retail prices. Actual retail prices may vary.



# 108 SPORTSTER®

## Foot Controls

### A. PASSENGER FOOTPEG MOUNT KIT – BLACK

A necessary addition when converting your solo seat Sportster® to a two-up passenger-carrying ride. Kit includes black mounting brackets, Original Equipment-style footpegs and all necessary mounting hardware.

**50500270** **\$114.95**

Fits '14-later XL models.

**50203-04** **\$114.95**

Fits '04-'13 XL models.

### B. PASSENGER FOOTPEG MOUNT KIT – CHROME

Nicely complements any passenger footpeg kit. We've taken the Original Equipment black-painted component to ensure product quality and polished and chrome-plated it for a great look. Footpegs sold separately.

**49322-04** **\$109.95**

Fits '04-'13 XL models. XL883, XL883L, XL883N, XL1200N, XL1200V and XL1200X models require separate purchase of four Screws P/N 4748.

**50610-86T** Fits '82-'03 XL models. **\$29.95**

### C. ADJUSTABLE PASSENGER FOOTPEG MOUNT KIT

Maximize your passenger's riding comfort. Proper foot position reduces the cramped or stretched-out feeling and relieves pressure on the knees and the tailbone. These Adjustable Mounts raise and lower the passenger footpeg to accommodate taller and shorter passengers. Easy to adjust with common tools, the mount adjusts through a 360° range (depending on model), allowing both fore and aft and up and down height adjustment. Kit includes left and right adjustable support assembly and all required mounting hardware. Footpegs sold separately.

**50763-09** **\$149.95**

Fits models with H-D® male mount-style passenger footpeg supports (except Softail® models). Does not fit with Heel Raiser Footpeg Kit P/N 50178-09. Does not fit the rider position.



A. PASSENGER FOOTPEG MOUNT KIT – BLACK



B. PASSENGER FOOTPEG MOUNT KIT – CHROME (49322-04 SHOWN)

B. PASSENGER FOOTPEG MOUNT KIT – CHROME (50610-86T SHOWN)



C. ADJUSTABLE PASSENGER FOOTPEG MOUNT KIT

Notice: The prices appearing in this catalog are the manufacturer's suggested retail prices. Actual retail prices may vary.

**NEW**

# SPORTSTER® 109

Gauges &amp; Fuel Tank Trim

**D. COMBINATION DIGITAL SPEEDOMETER/ANALOG TACHOMETER – 4"****D. COMBINATION DIGITAL SPEEDOMETER/ANALOG TACHOMETER – 4"**

Maintain the clean view over the handlebar. This unique Combination Digital Speedometer/Analog Tachometer allows you to monitor engine speed, fuel level and gear position, without adding additional handlebar-mounted gauges. The digital speed reading can be easily toggled between MPH and km/h to simplify cross-border travel. The large, easy-to-read LCD odometer/tripmeter also displays fuel level, miles-to-empty, gear position and time. The gauge features push-button adjustable backlighting with over 600 color tone options, allowing the rider to adjust pointer, LCD and backlighting colors to match any paint scheme or viewing preference. The unit mounts in the stock dash opening and is a direct plug-in installation. Kit includes a data transfer cable to easily upload initial mileage at time of installation.

NOTE: As a result of different vehicle capabilities, the following exceptions apply: Gear position not available on '04-'07 models, Range function not available on '04-'06 XL models and '04-'08 Dyna® models, Fuel level function not available on '04-'06 XL models.

**70900475** Spun Aluminum Dial, MPH/km/h **\$314.95**  
U.S. models. Fits '14-later XL, '12-later Dyna and '11-later Softail® models equipped with 4" speedometer. XL models require separate purchase of Fuel Sensor Kit P/N 61200008 to make use of the fuel level and range function.

**70900100C** **\$314.95**  
Non-U.S. models. Fits '14-later XL, '12-later FXDB and FXDWG, '11-later FXCW, FXS and FXSB models with 4" speedometer. XL models require separate purchase of Fuel Sensor Kit P/N 61200008 for fuel level and range function.

**70900274** **\$309.94**  
Worldwide models. Fits '04-'13 XL models (except XR, '04-'08 XL1200R and XL50), '04-'11 Dyna models with 4" speedometer and '08-'10 FXCW and FXCWC models. '07-'13 XL models require separate purchase of Fuel Sensor Kit P/N 61200008 to make use of the fuel level and range function. Does not fit XL883 models equipped with Screamin' Eagle® 1200cc Stage I Conversion Kit P/N 29784-07 and 30003-10.

**Also available:****FUEL LEVEL SENSOR KIT**

**61200008** **\$139.95**  
Fits '07-later XL models equipped with Combination Digital Speedometer/Analog Tachometer P/N 70900274, 70900100C or 70900475.

**E. SPORTSTER® FUEL GAUGE KIT\***

Finally, keep an eye on your Sportster® model fuel level without watching how many miles you have traveled. In-tank sending unit employs capacitive sensing technology to accurately monitor the fuel level and relays the information to a handlebar-mounted LED indicator for at-a-glance viewing. The segmented LED display is set into a distinctive housing that replaces the brake master cylinder cover on the right hand control. The individual LED segments glow when the tank is full and count down one-by-one as the fuel level drops. Available in black or chrome finish to match your Original Equipment satin black or accessory chrome hand controls. Kit includes sending unit, LED master cylinder cover, wiring harness and all necessary installation hardware.

Fits '07-later XL and '08-'13 XR models. '14-later XL models require separate purchase of Electrical Connection Kit 72673-11.

**75031-09** Black. **\$299.95**

**75338-09** Chrome. **\$299.95**

\*Some local regulations prohibit using colored lights during vehicle operation on public streets. May not conform to local lighting regulations.

**F. FUEL TANK TRIM PANEL KIT – CHROME**

Set your fuel tank apart from the rest with this mirror-chrome Fuel Tank Trim Panel. Fits around the stock fuel cap and is adhesive backed.

**61653-04** **\$124.95**  
Fits '04-later XL883C, XL1200L, XL1200C and '08-later XL1200R models. Also fits '04-later XL models equipped with a Sportster® Large Capacity Fuel Tank and Installation Kit P/N 62999-04 or 62999-07.

**E. SPORTSTER FUEL GAUGE KIT – CHROME****E. SPORTSTER FUEL GAUGE KIT – BLACK****F. FUEL TANK TRIM PANEL KIT – CHROME**

Notice: The prices appearing in this catalog are the manufacturer's suggested retail prices. Actual retail prices may vary.

**SPORTSTER**



# 110 SPORTSTER®

## Chassis Trim – Front End

### A. LOWER FORK SLIDERS – GLOSS BLACK

These gloss black coated sliders are the ultimate extension of your bike's "dark side" and make a perfect custom addition to your blacked-out ride. Manufactured to Original Equipment specifications, the durable black coating is a great match to other H-D® black components.

**45500261** **\$429.95**  
Fits '14-later XL883L and XL1200T models.

### B. LOWER FORK SLIDERS – CHROME

Competitively priced, these chrome-plated Lower Fork Sliders give your bike upfront style. A perfect addition during the installation of Profile Low® Front suspension components. To ensure proper fitment and function, these sliders are manufactured from Original Equipment components. Form follows function, with polished triple chrome-plating and a stamped "Harley-Davidson" script logo for product identification.

**45500258** **\$429.95**  
Fits '14-later XL883L and XL1200T models.

**45500226** **\$429.95**  
Fits '11-later XL1200C models.

**45500238** **\$429.95**  
Fits '14-later XL1200V models.

**46562-04A** **\$429.95**  
Fits '08-'13 XL1200L, XL1200V and '08-'10 XL models (except XL883N, XL883R, XL1200N, XL1200R and XL1200X).

**46492-00** **\$429.95**  
Fits '00-'07 XL models (except XL883R, XL1200S and XL1200R) and '00-'03 FXD and '01-'03 FXDL models.

**45275-98** **\$429.95**  
Fits '88-'99 XL models and FXD Super Glide®, '87-later FXLR and '88-'99 FXR and FXRS. (Does not fit Sportster® Sport models.)

### C. FRONT END KITS – CHROME\*

The front forks on a Harley-Davidson® motorcycle set the tone for the bike and can lead the way to a full-bore custom statement. So start customizing by adding chrome where it will have the most noticeable impact on the overall look of the bike; your front end. This package includes components necessary to completely chrome the front forks and includes some or all of the following (Kit components vary depending on your model): Chrome Fork Sliders, Chrome Fork Axle Retainer Nut Kit, Chrome Fork Slider Drain Screw Kit, Chrome Front Wheel Spacers, Classic Chrome Front Axle Nut Cover Kit and Chrome Upper Fork Nut Covers.

**46331-08A** **\$529.95**  
Fits '08-'11 XL1200L and '08-'10 XL883, XL883L, XL883C and XL1200C models.

**46331-04** **\$529.95**  
Fits '00-'07 XL models (except XL883R, XL1200R and XL1200S).

\*Chrome Front End Package price does not include labor or supplies.



A. LOWER FORK SLIDERS – GLOSS BLACK



B. LOWER FORK SLIDERS – ('14-LATER XL1200V SHOWN)



B. LOWER FORK SLIDERS – ('14-LATER XL1200C SHOWN)



B. LOWER FORK SLIDERS – CHROME



C. FRONT END KITS – CHROME

Notice: The prices appearing in this catalog are the manufacturer's suggested retail prices. Actual retail prices may vary.



**D. FRONT AXLE NUT COVERS – CHROME**



**D. FRONT AXLE NUT COVERS – GLOSS BLACK**

NEW



**E. "H-D MOTOR CO." LOGO FRONT AXLE NUT COVERS**



**F. BURST FRONT AXLE NUT COVERS**

NEW



**G. WILLIE G SKULL FRONT AXLE NUT COVERS**



**H. ALUMINATOR FRONT AXLE NUT COVERS**



**I. FRONT WHEEL SPACERS – CHROME TAPERED**



**I. FRONT WHEEL SPACERS – CHROME STRAIGHT**

#### D. FRONT AXLE NUT COVERS

Cover the front axle in style. Available in chrome or gloss black finish, custom Axle Nut Covers look great with Original Equipment satin-finish fork sliders or add the finishing touch to a complete chrome or blacked-out front end. These Axle Cover Kits are easy to install and include all necessary mounting hardware. Sold in pairs.

Fits '02-'11 VRSC™ (except VRSCF, VRSCR and '12-later VRSCDX), '15-later XG, '08-later XL, '08-later Dyna®, '07-later Softail® (except Springer™, FXCW, FXCWC, FLSTNSE, FXSBSE, FXST-Aus and FXSTD) and '08-later Touring and Trike models.

<b>44117-07A</b>	Chrome – Die-cast.	<b>\$27.95</b>
<b>43000026</b>	Gloss Black – Die-cast.	<b>\$27.95</b>
<b>44116-07A</b>	Chrome – Billet.	<b>\$42.95</b>
<b>43428-09</b>	Gloss Black – Billet.	<b>\$42.95</b>

Fits '88-'07 XL, '91-'03 Dyna FXD, FXDX, FXDXT, FXDL, FXDS-CONV.; '93-'05 FXDWG, '84-'06 Softail (except Springer and FXSTD), '80-'99 Touring models. Also fits '88-'07 FXR and '87-later FLXR/FXRS-SP, FXWG models.

<b>43899-86A</b>	Chrome – Die-cast.	<b>\$27.95</b>
------------------	--------------------	----------------

#### E. "H-D MOTOR CO." LOGO FRONT AXLE NUT COVERS

Die-cast, chrome-plated covers feature the "Harley-Davidson Motor Co." logo in black. Includes Allen®-head set screws and wrench for easy installation.

<b>44148-07A</b>		<b>\$29.95</b>
------------------	--	----------------

Fits '02-'11 VRSC (except VRSCF, VRSCR and '12-later VRSCDX), '15-later XG, '08-later XL, '08-later Dyna, '07-later Softail (except Springer, FXCW, FXCWC, FXSB, FXSBSE, FXST-Aus, FXSTD and FLSTNSE) and '08-later Touring and Trike models.

#### F. BURST FRONT AXLE NUT COVERS

Finish your blacked-out forks in style. Rich black and prismatic machined surfaces provide the contrast and the race-track ridges and the inner spider design make a powerful visual statement. Easy to install kit includes mounting hardware.

<b>43000031</b>		<b>\$69.95</b>
-----------------	--	----------------

Fits '02-'11 VRSC (except VRSCF, VRSCR and '12-later VRSCDX), '15-later XG, '08-later XL, '08-later Dyna, '07-later Softail (except Springer, FXCW, FXCWC, FXSB, FXSBSE, FXSTD and FLSTNSE) and '08-later Touring models.

#### G. WILLIE G SKULL FRONT AXLE NUT COVERS

Add a little attitude to your ride. Styled to complement Harley-Davidson® Skull accessory items, the menacing raised skull with black-filled eyes leaps from a field of chrome. The surrounding "Harley-Davidson Motorcycles" script is the perfect finishing touch. The Axle Nut Covers are easy to install and include all necessary mounting hardware. Sold in pairs.

<b>43163-08A</b>		<b>\$34.95</b>
------------------	--	----------------

Fits '02-'11 VRSC (except VRSCF, VRSCR and '12-later VRSCDX), '15-later XG, '88-later XL, '91-later Dyna, '84-later Softail (except Springer, FXCW, FXCWC, FXSB, FXSBSE, FXSTD and FLSTNSE), '99-later Touring and '08-later Trike models.

#### H. ALUMINATOR® FRONT AXLE NUT COVERS

Chrome-plated billet aluminum axle covers feature a classic Bar & Shield logo insert. Includes all necessary mounting hardware for easy installation.

<b>43907-94</b>		<b>\$42.95</b>
-----------------	--	----------------

Fits '88-'07 XL, '91-'03 Dyna FXD, FXDX, FXDXT, FXDL, FXDS-CONV.; '93-'05 FXDWG, '84-'06 Softail (except Springer and FXSTD), '80-'99 Touring models. Also fits '88-'07 FXR and '87-later FLXR/FXRS-SP, FXWG models.

#### I. FRONT WHEEL SPACERS – CHROME

Complete your total front end with these highly polished chrome-plated wheel spacers. Manufactured to the Original Equipment tolerances, they deliver exact fitment and custom shine.

<b>41370-08</b>	Tapered.	<b>\$29.95</b>
-----------------	----------	----------------

Fits '08-'13 XL models (except XL1200X, XL883L and '11-'13 XL1200C).

<b>41616-02</b>	Straight.	<b>\$29.95</b>
-----------------	-----------	----------------

Fits '00-'07 XL models and '00-'03 FXD, FXDL, FXDX, FXDXT and FXDS-CONV. models.



## 112 SPORTSTER®

### Chassis Trim – Front End

#### A. FORK AXLE RETAINER NUT KIT – CHROME

It's the details that count. Complete the chrome transformation by adding this finishing touch to your chrome fork sliders. This Axle Retainer Nut Kit includes the stylish chrome-plated nuts and chrome lockwashers necessary to replace the stock hardware.

**45802-03** **\$8.95**

Fits '88-later XL models, '93-'05 FXD, FXDL, FXDS-CONV., FXDX, FXDX-T models and '88-'94 FXR, FXRS, FXRS-SP, FXRS-CONV., FXLR, FXRT models.

#### Shown with:

#### FORK SLIDER DRAIN SCREW KIT – CHROME

This Fork Slider Drain Screw Kit includes two chrome-plated drain screws and the seals required to replace the stock hardware.

**45815-03** **\$3.95**

Fits '73-'13 XL models (except XL Sport, XL883L, XL1200X and '11-later XL1200C), '78-'86 FX models, '94-'05 Dyna® FXD/DL/DS-CONV., '99-'00 FXR2/3/4 models and '00-'07 FXSTD models.



**A. FORK AXLE RETAINER NUT KIT – CHROME (SHOWN WITH CHROME DRAIN SCREW KIT)**

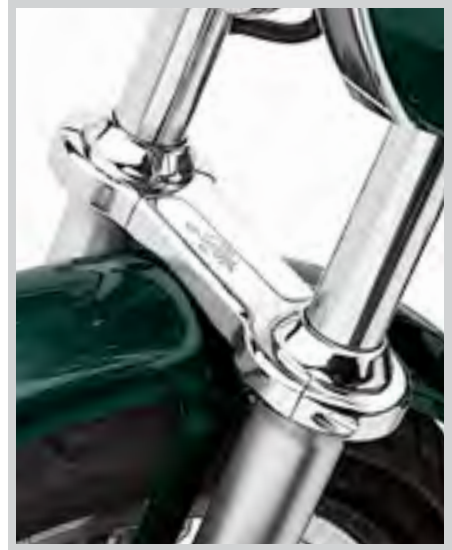

**B. SCREAMIN' EAGLE FORK BRACE – CHROME**

#### B. SCREAMIN' EAGLE® FORK BRACE – CHROME

This Chrome Fork Brace is machined from billet aluminum, then polished and chrome-plated. Easy to install, this brace offers increased torsional rigidity.

**46192-99A** **\$219.95**

Fits '87-later XL (except XL883N, XL883L, XL1200N, XL1200T, XL1200X, '11-later XL1200C), '91-'05 Dyna (except FXDWG) and FXR models (except FXRT) with 39mm front forks. (Will not fit with Chrome Fork Sliders).

#### C. UPPER FORK STEM COVERS – CHROME

Highlighted with a unique Bar & Shield logo, these polished triple chrome-plated covers add an additional clean-looking appearance to your upper fork. Kit comes complete with three covers, mounting hardware and wrench for easy on-the-spot installation.

**46129-98B** **\$59.95**

Fits '86-later FLSTC, '90-later FLS, FLSTF, '95-'05 FXD, '93-'05 FXDL, '94-'05 FXDS-CONV. and '88-'13 XL models (except XL Custom and XL1200S models.)



**C. UPPER FORK STEM COVERS – CHROME**

#### D. CLASSIC CHROME STEERING STEM BOLT COVER KIT

For a finished appearance of the upper fork clamp on all models with 39mm forks.

**48329-90A** **\$39.95**

Fits XL, '91-'05 Dyna and FXR models with 39mm forks. (Does not fit FXDWG.)



**D. CLASSIC CHROME STEERING STEM BOLT COVER KIT**

#### E. HEADLAMP BRACKET – CHROME

Replace stock aluminum with this chrome-plated visor eyebrow, one part of a perfectly chromed front end.

**69709-00A** **\$69.95**

Fits '92-later XL models (except XL883C, XL1200C, XL1200V, XL1200T, XL1200X and XL Custom) and '93-'05 Dyna models (except FXDWG).



**E. HEADLAMP BRACKET – CHROME**

#### F. HEADLIGHT COVER – CHROME

Cover the Original Equipment aluminum headlamp eyebrow with this polished and chrome-plated cover.

**67871-85TA** With Cutout. **\$20.95**

Fits '60-later XL models (except '96-later XL Custom, XL1200V and XL1200X), '91-'05 FXDL, '71-'13 FX and FXR models (except FXWG, FXSB, FXSBSE and FXST).

**67884-90TA** Without Cutout. **\$20.95**

Fits XL models (except '96-later XL Custom, XL1200V, XL1200X), FXR models with indicator lights mounted in speedometer bracket and '91-'05 Dyna models (except FXDWG).



**F. HEADLIGHT COVER – CHROME (WITH CUTOUT)**



**F. HEADLIGHT COVER – CHROME (WITHOUT CUTOUT)**

*Notice: The prices appearing in this catalog are the manufacturer's suggested retail prices. Actual retail prices may vary.*



NEW

**G. BRAKE CALIPER KIT – RED**  
(41300134 SHOWN)



NEW

**G. BRAKE CALIPER KIT – RED**  
(41300134 SHOWN)



NEW

**G. BRAKE CALIPER KIT – RED**  
(41300131 SHOWN)



NEW

**G. BRAKE CALIPER KIT – RED**  
(41300142 SHOWN)



NEW

**G. BRAKE CALIPER KIT – RED**  
(41300126 SHOWN)



NEW

**G. BRAKE CALIPER KIT – RED**  
(41300120 SHOWN)



**H. BRAKE CALIPER KIT – CHROME**



**I. BRAKE CALIPER INSERTS**

### G. BRAKE CALIPER KIT – RED

Dress your bike in the latest high-performance look. Brilliant red calipers make a powerful visual statement and set your bike apart from the ordinary. Manufactured from Original Equipment components for proven performance, these calipers will add a stylish touch to the stock bike or add the perfect finish to a complete custom equipped with chrome or blacked-out wheels, rotors and fork sliders.

**41300134** Front & Rear Kit. **\$399.95**

Fits '14-later XL models with single disc front brakes. Kit includes one front and one rear caliper. Includes brake pads.

**41300131** Front & Rear Kit. **\$399.95**

Fits '11-'13 XL models equipped with single disc front brakes. The kit includes one front and one rear caliper. Includes brake pads.

**41300142** Front & Rear Kit. **\$399.95**

Fits '08-'10 XL models equipped with single disc front brakes. The kit includes one front and one rear caliper. Includes brake pads.

**41300126** Front – Single Disc. **\$249.95**  
Fits '00-'03 XL, '00-'07 Dyna® and '00-'07 Softail® models with single disc front brakes. Brake pads sold separately.

**41300120** Front – Dual Disc. **\$399.95**

Fits '02-'05 VRSC, '00-'03 XL, '00-'07 Dyna and '00-'07 Touring models with dual disc front brakes. Brake pads sold separately.

### H. BRAKE CALIPER KIT – CHROME

Add the shine of chrome to your front end with this highly-polished Chrome Front Brake Caliper Kit. Manufactured from Original Equipment components for proven performance, these calipers are a great addition to the stock front end or they add the finishing touch to a complete custom with chrome wheels, rotors and chrome fork sliders. (Brake pads and pad pins not included.)

**44395-00A** Front – Single Disc. **\$389.95**

Fits '00-'03 XL and '00-'07 Dyna and Softail (except Springer™) models equipped with single disc front brakes.

**44392-00A** Front – Dual Disc. **\$799.95**

Fits '00-'03 XL, '02-'05 VRSC™ and '00-'07 Dyna, Softail and Touring models equipped with dual disc front brakes.

### I. BRAKE CALIPER INSERTS

Easy-to-install inserts add a finishing touch to the front and rear brake calipers. Select a style that follows your custom direction. Self-adhesive backing.

Fits front and rear calipers on '04-'13 XL models.

**1. 42070-07** Willie G Skull Collection. **\$16.95**

**2. 44621-04** "H-D Motor Co." Logo Collection. **\$16.95**

**3. 44622-04** "Live to Ride" Logo Collection. **\$16.95**

**4. 44623-04** Flames Collection. **\$16.95**



# 114 SPORTSTER®

## Chassis Trim – Rear End

### A. UPPER BELT GUARD – CHROME

Attract attention to your Sportster® motorcycle by replacing the black Original Equipment component, providing exceptional chrome-plated detail to the rear drive system. Easy to clean and simple to install.

**60402-04** Fits '04-later XL models. **\$89.95**

### B. BUCKSHOT UPPER BELT GUARD – GLOSS BLACK

Add the “blacked-out” look of the Nightster® motorcycle to your Sportster model. The perforated “Buckshot” design visually lightens the belt guard and adds a raw, purposeful edge to the bike’s profile.

**60379-09** **\$89.95**  
Fits '04-later XL models.

### C. BUCKSHOT UPPER BELT GUARD – BRUSHED NICKEL

This perforated “Buckshot” belt guard design visually lightens the bike’s profile and adds a raw, mechanical edge to the overall look. Available in brushed nickel “Silencer” finish, this easy-to-install guard provides a stripped-down open look while protecting the belt from road debris.

**60300045** Fits '04-later XL models. **\$89.95**

### D. LOWER BELT GUARD – CHROME

This handsome steel cover is polished, chrome-plated and designed to replace the Original Equipment black plastic cover. Easy to install, this guard looks great when combined with a Harley-Davidson® Chrome Upper Belt Guard.

**57100226** Fits '04-later XL models. **\$99.95**

### E. SWINGARM – CHROME

The ultimate chrome accessory, polished to the highest standard using bright plating to match Original Equipment chrome. Affordable and convenient, with no troublesome exchanges necessary. Factory specifications guarantee exact fitment, unparalleled quality and an affordable price. Stamped with the Harley-Davidson Bar & Shield logo.

**48434-05A** **\$249.95**  
Fits '05-later XL models (except XL1200T).



**A. UPPER BELT GUARD – CHROME**  
(SHOWN WITH CHROME LOWER BELT GUARD AND SWINGARM)



**B. BUCKSHOT UPPER BELT GUARD – GLOSS BLACK**



**C. BUCKSHOT UPPER BELT GUARD – BRUSHED NICKEL**



**D. LOWER BELT GUARD – CHROME**



**E. SWINGARM – CHROME**

*Notice: The prices appearing in this catalog are the manufacturer's suggested retail prices. Actual retail prices may vary.*



F. SHOCK BOLT COVERS – CHROME



F. SHOCK BOLT COVERS – GLOSS BLACK



G. BAR &amp; SHIELD LOGO REAR AXLE COVERS – CHROME



G. BAR &amp; SHIELD LOGO REAR AXLE COVERS – GLOSS BLACK



H. SWINGARM PIVOT BOLT COVERS – CHROME



H. SWINGARM PIVOT BOLT COVERS – GLOSS BLACK



I. SWINGARM PIVOT BOLT COVERS – WILLIE G SKULL COLLECTION



J. REAR BRAKE RESERVOIR COVER

**F. SHOCK BOLT COVERS**

It's the details that complete the look of your bike. These Shock Bolt Covers are designed to hide the upper shock mounting hardware and provide a custom look to the rear of your bike. Easy-to-install, the kit includes left and right bolt covers and all required mounting hardware.

Fits '04-later XL and '06-later Dyna® models (except FLD, FXDF and FXDL).

<b>54000016</b>	Chrome.	<b>\$39.95</b>
<b>54000017</b>	Gloss Black.	<b>\$39.95</b>

**G. BAR & SHIELD LOGO REAR AXLE COVERS**

Die-cast cover conceals the side of the swingarm and axle. Unique styling features an embossed Bar & Shield logo. Easy to install without removing the rear wheel. Kit includes all necessary mounting hardware.

Fits '05-later XL883C, XL883L, XL883N, XL1200C, XL1200L, XL1200N, XL1200V and XL1200X models. Also fits '05-later XL models equipped with Low Rear Suspension Kit P/N 54731-04, 54733-04 or 54750-05. (Will not fit models equipped with saddlebags or Chrome Billet Shock Hardware Kit P/N 54337-05.)

<b>46399-05A</b>	Chrome.	<b>\$54.95</b>
<b>43013-09A</b>	Gloss Black.	<b>\$54.95</b>

**H. SWINGARM PIVOT BOLT COVERS**

Cover the swingarm pivot bolt in classic style. Available in your choice of chrome or gloss black finish, these easy-to-install kits include left and right die-cast pivot bolt covers and necessary mounting hardware.

Fits '04-'13 XL models.

<b>43580-04</b>	Chrome.	<b>\$29.95</b>
<b>47625-09</b>	Gloss Black.	<b>\$31.95</b>

**I. SWINGARM PIVOT BOLT COVERS – WILLIE G SKULL COLLECTION**

Add a little attitude to your ride. Styled to complement Harley-Davidson® Skull accessory items, the menacing raised skull with black-filled eyes leaps from a field of chrome. The surrounding "Harley-Davidson Motorcycles" script is the perfect finishing touch. This easy-to-install kit includes left and right pivot bolt covers and necessary mounting hardware.

<b>42072-07</b>	Fits '04-'13 XL models.	<b>\$31.95</b>
-----------------	-------------------------	----------------

**J. REAR BRAKE RESERVOIR COVER**

Dress the remote brake fluid reservoir with a new chrome skin. Kit includes chrome top cover with Bar & Shield medallion, reservoir side cover, chrome hardware and a Torx® wrench for easy installation.

<b>45424-08</b>	Fits '07-'13 XL models.	<b>\$35.95</b>
<b>45762-04</b>	Fits '04-'06 XL models.	<b>\$35.95</b>

Notice: The prices appearing in this catalog are the manufacturer's suggested retail prices. Actual retail prices may vary.



# 116 SPORTSTER®

## Chassis Trim – Rear End

### A. "BIG SPOKE" SPROCKET COVER – CHROME

Muscle rules. Big, beefy spokes define the distinctive hot rod styling and the small trapezoidal openings are reminiscent of Detroit's street performance wheels of the late '60s. The chrome-plated steel cover disguises the Original Equipment sprocket and complements both stock and custom wheels. Easy to install, this cover provides the look of a billet sprocket at a fraction of the cost.

**40124-10** Fits '04-later XL and XR models. **\$49.95**



A. "BIG SPOKE" SPROCKET COVER – CHROME

### B. SPROCKET COVER – CHROME

The five-spoke Sprocket Cover matches the styling of the Original Equipment sprocket, providing the appearance of a chrome sprocket at a fraction of the cost. The raised ribs mimic the look of a billet sprocket. Easy to install, the cover looks great with Chrome Upper and Lower Belt Guards.

**91746-03** Fits '04-later XL and XR models. **\$49.95**



B. SPROCKET COVER – CHROME

### C. SPROCKET COVER WITH HOLES – CHROME

This handsome steel cover is polished and chrome-plated. Easy to install and looks great when combined with Harley-Davidson® Chrome Belt Guard. Chrome Hardware Kit P/N 94708-98 completes the look.

**40279-91A** Fits '91-'03 XL models. **\$49.95**



C. SPROCKET COVER WITH HOLES – CHROME

### D. SPROCKET HARDWARE – CHROME HEX HEAD

This kit includes highly-polished, chrome-plated, grade 8 hex-head screws with chrome-plated washers, providing an extra custom accent. The perfect addition to the chrome sprocket. Made from the same Original Equipment bolts to ensure product integrity. Also works with chrome belt sprocket covers and Original Equipment sprockets.

**94708-98** **\$29.95**  
Fits '93-'99 Softail®, '93-'99 Dyna®, '91-later XL models.



D. SPROCKET HARDWARE – CHROME HEX HEAD

### E. REAR SPROCKET BOLT COVER KIT

These chrome-plated covers with internal spring clips hide the Original Equipment sprocket bolts for a clean, custom look. Set of 5 covers.

**43876-04** **\$38.95**

Fits '93-later Softail, '99-later Touring and '04-later XL models with Original Equipment 7/16" hex head sprocket mounting bolts (5/8" hex across the flats).



E. REAR SPROCKET BOLT COVER KIT

### F. FRONT ENGINE MOUNT BRACKET

A must-have for any chrome connoisseur; this chrome-plated Front Engine Mount Bracket will set your custom apart from the rest. The chrome bracket is machined from premium 6061-T6 aluminum and is a direct bolt-on replacement for the Original Equipment upper bracket. Can be used with the stock stabilizer link or dressed up with the optional chrome Front Engine Mount Stabilizer Link P/N 16400020. Kit includes chrome mounting hardware.

**16400022** **\$129.95**  
Fits '04-later XL models.



F. FRONT ENGINE MOUNT BRACKET

### G. FRONT ENGINE MOUNT STABILIZER LINK

Add a custom style to the front end with this brilliant chrome-plated Engine Mount Stabilizer Link. This custom heim joint assembly is designed to link the engine to the engine mount bracket and can be used to replace the Original Equipment upper or lower front tie link. For a complete transformation, install two Stabilizer Links and the complementing chrome Billet Front Engine Mount Bracket P/N 16400022. Kit includes one stabilizer link and chrome mounting hardware.

**16400020** **\$49.95**  
Fits '04-later XL and XR models.



G. FRONT ENGINE MOUNT STABILIZER LINK

*Notice: The prices appearing in this catalog are the manufacturer's suggested retail prices. Actual retail prices may vary.*



H. CHROME ENGINE KIT – SPORTSTER

**H. CHROME ENGINE KIT – SPORTSTER®**

Upgrade your motor with brilliant chrome components. Kit includes chrome gear cover, transmission sprocket cover, primary chain inspection cover, derby cover, inner and outer rocker covers and all gaskets.

**16295-07A** \$949.95

Fits '07-later XL models. Stock on '07-later XL1200C, XL1200L, XL1200T, XL1200V and XL 50th Anniversary models.

**I. SPORTSTER ENGINE COVERS – CHROME****1. Gearcase Cover**

**25213-04** Fits '04-later XL models. \$439.95

**25213-96B** Fits '91-'03 XL models. \$439.95

**2. Transmission Sprocket Cover**

**34932-06** Fits '04-later XL models. \$129.95

**34932-94** Fits '91-'03 XL models. \$139.95

**3. Rocker Box Lower Housing (each)**

**17537-07A** Fits '07-later XL models. \$114.95

**17537-96C** Fits '86-'06 XL models. \$114.95

**4. Rocker Box Cover (each)**

**17551-04** Fits '04-later XL models. \$98.95

**17551-96** Fits '86-'03 XL models. \$98.95

**5. Rocker Cover Spacer (each)**

**17538-96** Fits '91-'03 XL models. \$145.95

**6. Primary Cover**

**25460-06** Fits '06-later XL models. \$349.95

**25460-04** Fits '04-'05 XL models. \$349.95

**25460-94** Fits '94-'03 XL models. \$349.95

**7. Primary Chain Inspection Cover**

**34761-04A** Fits '04-later XL models. \$24.95

**34761-94** Fits '94-'03 XL models. \$39.95

**8. Derby Cover**

**34760-04** Fits '04-later XL models. \$69.95

**34760-94** Fits '94-'03 XL models. \$99.95

**9. Shift Lever**

**34606-90T** Fits '91-'03 XL models. \$62.50

**J. SPORTSTER ENGINE COVERS – WRINKLE BLACK****1. Gearcase Cover**

**25486-05** Fits '04-later XL models. \$369.95

**2. Transmission Sprocket Cover**

**34943-05** Fits '04-later XL models. \$81.95

**3. Rocker Box Lower Housing (each)**

**17645-07A** Fits '07-later XL models. \$89.95

**17645-06A** Fits '86-'06 XL models. \$89.95

**4. Rocker Box Cover (each)**

**17655-05** Fits '04-later XL models. \$74.95

**5. Primary Cover**

**25307-06** Fits '06-later XL models. \$269.95

**6. Primary Chain Inspection Cover**

**34794-05A** Fits '04-later XL models. \$19.95

**7. Derby Cover**

**34790-05** Fits '04-later XL models. \$39.95

NOTE: Removing and installing engine covers may require purchase of new gaskets. See dealer for information.



I. SPORTSTER ENGINE COVERS – CHROME ('86-'03 MODELS SHOWN)



J. SPORTSTER ENGINE COVERS – WRINKLE BLACK

Notice: The prices appearing in this catalog are the manufacturer's suggested retail prices. Actual retail prices may vary.



# 118 SPORTSTER®

## Engine & Transmission Trim

### A. PRIMARY COVER TRIM – CHROME

Dress your engine in chrome. This precision-stamped steel cover wraps the Original Equipment aluminum primary cover in brilliant chrome, at a fraction of the cost of chrome replacement components. Kit includes chrome-plated installation hardware.

**25233-04** **\$124.95**

Fits '04-later XL and XR models. (Does not fit with Primary and Cylinder Base Cover Trim P/N 25700196 or 25700194.)



A. PRIMARY COVER TRIM – CHROME



A. PRIMARY COVER TRIM – CHROME

### B. ENGINE SPROCKET COVER TRIM – CHROME

This chrome-plated steel skin fits over the Original Equipment aluminum sprocket cover, giving the appearance of a chrome engine at a fraction of the cost. When combined with the available Chrome Gearcase Cover Trim, you get a complete chrome look from front to rear. Kit includes chrome-plated mounting hardware.

**34944-04** Fits '04-later XL models. **\$44.95**



B. ENGINE SPROCKET COVER TRIM – CHROME



C. GEARCASE COVER TRIM – CHROME

### C. GEARCASE COVER TRIM – CHROME

Rather than spending the time and money on chrome exchanges, this brilliant chrome cover fits over the Original Equipment aluminum gearcase like a second skin. This steel cover is shaped to mirror the contour for a perfect fit and when matched with Chrome Engine Sprocket Cover Trim, is a simple way to add instant style. Kit includes chrome-plated mounting hardware.

**25231-04** Fits '04-later XL models. **\$89.95**

### D. PRIMARY AND CYLINDER BASE COVER TRIM

Get the look of a custom outer primary and engine crankcase with one custom cover. These ribbed covers are designed to wrap the top surface of the outer primary cover and provide a beefy finished look to the engine cases. Easy to install, the primary cover is secured with the outer primary hardware. To complete the look, the kit includes a matching cover that conceals the front and rear cylinder bases to provide a unified look to the left side of the engine. Kit includes required mounting hardware.

Fits '04-later XL models. Does not fit with Primary Cover Trim P/N 25233-04.

**25700196** Chrome. **\$119.95**

**25700194** Wrinkle Black. **\$119.95**



D. PRIMARY AND CYLINDER BASE COVER TRIM – CHROME



D. PRIMARY AND CYLINDER BASE COVER TRIM – WRINKLE BLACK



Notice: The prices appearing in this catalog are the manufacturer's suggested retail prices. Actual retail prices may vary.

# SPORTSTER® 119

Engine & Transmission Trim



**E. CYLINDER BASE COVER WITH BAR & SHIELD LOGO**



**F. CYLINDER BASE COVER**

**E. CYLINDER BASE COVER WITH BAR & SHIELD LOGO**

Add a finished chrome look to the left side of the Sportster® engine. The mirror-chrome surface complements both silver and black engine finishes and the deep embossed Bar & Shield logo provides a custom touch. Easy to install, the complete kit includes all necessary mounting hardware.

**32729-07** Fits '04-later XL models. **\$59.95**

**F. CYLINDER BASE COVER**

Adds chrome highlights to the left side of a Sportster model. Installs in minutes.

**32732-98** Fits '91-'03 XL models. **\$59.95**

**G. STARTER COVER**

Cover and conceal the starter motor and the area behind the rear cylinder with a splash of style. This shapely ribbed and slotted cover conceals the starter motor and starter solenoid for a clean, custom look. Kit includes all required mounting hardware.

Fits '04-later XL models.

**34800008** Chrome. **\$64.95**

**34800007** Wrinkle Black. **\$64.95**

**H. TAPPET BLOCK ACCENT**

Shaped to surround and fill the gap between the tappet blocks, this unique ribbed cover adds a splash of style to the profile of your engine. The easy-to-install cover is the perfect finishing touch to the bike's profile. Kit includes all necessary mounting hardware.

Fits '04-later XL models.

**25700197** Chrome. **\$64.95**

**25700195** Wrinkle Black. **\$64.95**

**I. TAPPET BLOCK COVER KIT**

This one-piece chrome-plated cover is designed to conceal the lifter blocks and hardware for a clean, custom look. Featuring an embossed Bar & Shield logo, this complete kit covers the lifter block area and extends the chrome look from the gearcase cover to the pushrod tubes. All exposed hardware is chrome-plated and the kit includes all necessary mounting hardware.

**18241-04** Fits '04-later XL models. **\$64.95**

**J. STARTER SOLENOID COVER KIT – CHROME**

Add chrome to an often overlooked area with this cover, featuring the same high-quality, bright finish used on most of our accessories.

**31783-00** **\$21.95**

Fits '94-later models (except '02-later VRSC™ and XG).



**G. STARTER COVER – CHROME**



**G. STARTER COVER – WRINKLE BLACK**



**H. TAPPET BLOCK ACCENT – CHROME**



**H. TAPPET BLOCK ACCENT – WRINKLE BLACK**



**I. TAPPET BLOCK COVER KIT**



**J. STARTER SOLENOID COVER KIT – CHROME**

*Notice: The prices appearing in this catalog are the manufacturer's suggested retail prices. Actual retail prices may vary.*



# 120 SPORTSTER®

Engine & Transmission Trim

## A. NUMBER ONE SKULL COLLECTION

The sinister Harley-Davidson #1 Skull logo dresses for a night on the town. This complete die-cast aluminum collection has been polished and chrome-plated to a brilliant shine, then finished with a contrasting black-filled Dark Custom™ Skull logo. The black-filled race track stripe and recessed hardware pockets provide added depth and dimension. Includes chrome-plated mounting hardware.

**1. 25333-10** Derby Cover. **\$74.95**  
Fits '04-later XL models.

**2. 32520-10** Timer Cover. **\$28.95**  
Fits '04-later XL, XR and earlier models with horizontal holes on timer cover.

**3. 27957-10** Air Cleaner Trim. **\$45.95**  
Fits '04-later XL models (except XL1200V) equipped with Original Equipment oval air cleaner cover.



A. NUMBER ONE SKULL COLLECTION

## B. DARK CUSTOM™ LOGO COLLECTION

The famous Harley-Davidson #1 logo with a sinister twist. Machined from billet aluminum, these covers feature domed surfaces that are polished and black anodized to a rich satin sheen, and then re-machined to expose the raw aluminum. The resulting high-contrast design complements both polished and painted engine finishes.

**1. 25563-09** Derby Cover. **\$144.95**  
Fits '04-later XL models.

**2. 32414-09** Timer Cover. **\$64.95**  
Fits '99-later Twin Cam-equipped models.

**3. 61300055** Air Cleaner Trim. **\$114.95**  
Fits '04-later XL models (except XL1200V) with Original Equipment oval air cleaner cover.



B. DARK CUSTOM LOGO COLLECTION

## C. SKULL & CHAIN COLLECTION – CHROME

Links to the dark side. This collection stands out in a crowd, with a contrasting 3-D chain that rims the surface and surrounds the distinctive raised Willie G Skull.

**1. 25700257** Derby Cover. **\$89.95**  
Fits '04-later XL and XR models. Includes chrome-plated stainless steel hardware.

**2. 25600027** Timer Cover. **\$41.95**  
Fits '04-later XL, XR and earlier models with horizontal holes on timer cover. Includes chrome-plated stainless steel hardware.



C. SKULL & CHAIN COLLECTION – CHROME

## D. SKULL & CHAIN COLLECTION – SMOKEY CHROME

The sinister smokey chrome finish is the ideal complement to the blacked-out ride, and the contrasting 3-D chain rims the surface and surrounds the distinctive Willie G Skull with black-filled eyes.

**1. 25700255** Derby Cover – Skull. **\$89.95**  
Fits '04-later XL and XR models. Includes chrome-plated stainless steel hardware.

**2. 25600025** Timer Cover – Skull. **\$41.95**  
Fits '04-later XL, XR and earlier models with horizontal holes on timer cover. Includes chrome-plated stainless steel hardware.



D. SKULL & CHAIN COLLECTION – SMOKEY CHROME

*Notice: The prices appearing in this catalog are the manufacturer's suggested retail prices. Actual retail prices may vary.*



E. WILLIE G SKULL COLLECTION

**E. WILLIE G SKULL COLLECTION**

Add a little attitude to your ride. Styled to complement Harley-Davidson® Skull accessory items, the menacing raised skull with black-filled eyes leaps from a field of chrome. The surrounding "Harley-Davidson Motorcycles" script is the perfect finishing touch. This complete collection of engine covers dresses your bike for a true custom look.

**1. 25440-04A** Derby Cover. **\$64.95**  
Fits '04-later XL and XR models. Includes chrome-plated stainless steel mounting hardware.

**2. 32972-04A** Timer Cover. **\$28.95**  
Fits '04-later XL, XR and earlier models with horizontal holes on timer cover. Includes chrome-plated stainless steel mounting hardware.

**3. 29416-04** Air Cleaner Trim. **\$43.95**  
Fits '04-later XL models (except XL1200V) equipped with Original Equipment oval air cleaner cover.



F. DIAMOND ICE COLLECTION

**F. DIAMOND ICE COLLECTION**

Add a touch of "bling" to your ride. Set against mirror-polished chrome, these crystal clear rhinestones add a brilliant flash, and dance in the direct sunlight. This complete line of engine trim is easy to install, and adds a bold and bright rhinestone-encrusted Bar & Shield logo to the profile of your bike. Kits include chrome-plated mounting hardware.

**1. 25341-10** Derby Cover. **\$89.95**  
Fits '04-later XL and XR models.

**2. 32541-10** Timer Cover. **\$49.95**  
Fits '04-later XL, XR and earlier models with horizontal holes on timer cover.

**3. 27961-10** Air Cleaner Trim. **\$59.95**  
Fits '04-later XL models (except XL1200V) equipped with Original Equipment oval air cleaner cover.

**G. THE FLAMES COLLECTION – GOLD & CHROME**

Ever since they began emerging on gas tanks a few decades ago, flames have been a symbol of custom styling. Now, Harley-Davidson continues the tradition with the Flames Collection.

**1. 25125-04A** Derby Cover. **\$69.95**  
Fits '04-later XL and XR models. Includes chrome-plated stainless steel mounting hardware.

**25400-98** Derby Cover (not shown). **\$64.95**  
Fits '94-'03 Sportster models.

**2. 32571-98A** Timer Cover. **\$28.95**  
Fits '04-later XL, XR and earlier models with horizontal holes on timer cover. Includes chrome-plated stainless steel mounting hardware.

**3. 29824-04** Air Cleaner Trim. **\$43.95**  
Fits '04-later XL models (except XL1200V) equipped with Original Equipment oval air cleaner.



G. THE FLAMES COLLECTION – GOLD &amp; CHROME

**H. HARLEY-DAVIDSON® MOTOR CO. COLLECTION**

This collection personifies Harley style. It had better, because we put our name on it – The Harley-Davidson Motor Co. Collection.

**1. 25130-04A** Derby Cover. **\$46.95**  
Fits '04-later XL and XR models. Includes chrome-plated stainless steel mounting hardware.

**25332-98** Derby Cover. (not shown) **\$46.95**  
Fits '94-'03 Sportster models.

**2. 32668-98A** Timer Cover. **\$25.95**  
Fits '04-later XL, XR and earlier models with horizontal holes on timer cover. Includes chrome-plated stainless steel mounting hardware.



H. HARLEY-DAVIDSON MOTOR CO. COLLECTION





# 122 SPORTSTER®

Engine & Transmission Trim

## A. THE HARLEY-DAVIDSON® “LIVE TO RIDE” COLLECTION – GOLD

“Live To Ride, Ride to Live.” It has become the motto of the Harley-Davidson nation, accompanying riders over millions of miles of travel. This collection is a tribute to that way of life.

**1. 25127-04A** Derby Cover. **\$69.95**  
Fits '04-later XL and XR models. Includes chrome-plated stainless steel mounting hardware.

**25398-95T** Derby Cover. (not shown) **\$64.95**  
Fits '94-'03 Sportster models.

**2. 32585-90T** Timer Cover. **\$37.95**  
Fits models with vertical mounting holes.

**32581-90TB** Timer Cover. (not shown) **\$37.95**  
Fits '04-later XL, XR and earlier models with horizontal holes on timer cover. Includes chrome-plated stainless steel mounting hardware.

**3. 29823-04** Air Cleaner Trim. **\$43.95**  
Fits '04-later XL models (except XL1200V) equipped with Original Equipment oval air cleaner.

**4. 29405-90T** Oval Air Cleaner Trim. **\$49.95**  
Fits '66-'78 and '83-'03 XL models, '67-early '78 FL and '71-early '78 FX models.

## B. CLASSIC CHROME COVERS

From the design philosophy of less is more, we bring you this collection of basic chrome accessories, which provides a clean, custom look that is guaranteed to turn heads.

**1. 34760-04** Derby Cover. **\$69.95**  
Fits '04-later XL models.

**2. 32584-88TA** Timer Cover. **\$25.95**  
Fits '04-later XL, XR and earlier models with horizontal holes on timer cover. Includes chrome-plated stainless steel mounting hardware.

**3. 34761-94** Chain Inspection Cover. **\$39.95**  
Fits '94-'03 XL models.

**34761-04A** Chain Inspection Cover. (not shown) **\$24.95**  
Fits '04-later XL models.

## C. BLACK DERBY COVERS

Available in wrinkle black, this simple Derby Cover adds a finishing touch to your blacked-out engine.

**34790-05** Wrinkle Black. **\$39.95**  
Fits '04-later XL models.

## D. CLASSIC COVERS KIT

Customize your bike down to the last detail. These hardware Cover Kits include the chrome-plated ABS caps and plugs in the sizes and styles required to dress the viewable hardware on the motorcycle. Classic Covers are available as complete Bike Kits with the covers for both engine and chassis hardware, or as engine-only kits to dress the Twin Cam or XL engine. The kits are easy to install, with no tools required.

**94946-07** Bike Kit. **\$194.95**  
Fits '04-later XL models.

**94944-07** Engine Kit. **\$144.95**  
Fits '04-later XL models.



A. THE HARLEY-DAVIDSON “LIVE TO RIDE” COLLECTION – GOLD

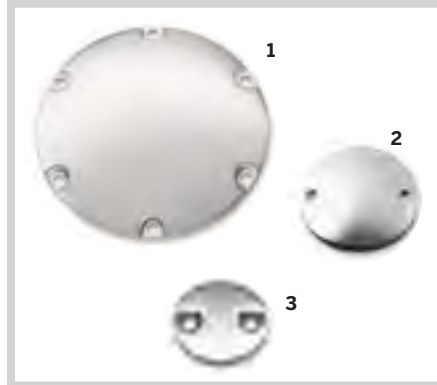

B. CLASSIC CHROME COVERS



C. BLACK DERBY COVERS



D. CLASSIC COVERS KIT



D. CLASSIC COVERS KIT – BIKE



D. CLASSIC COVERS KIT – ENGINE

Notice: The prices appearing in this catalog are the manufacturer's suggested retail prices. Actual retail prices may vary.

# SPORTSTER® 123

Engine & Transmission Trim



**E. FINNED HEADBOLT BRIDGE – BLACK HIGHLIGHTED**



**E. FINNED HEADBOLT BRIDGE – SOLID BLACK**

## E. FINNED HEADBOLT BRIDGE

This exclusive aluminum Finned Headbolt Bridge covers both headbolts and the spark plug, filling out your cylinder fins all the way to the rocker box. Featuring an engraved Bar & Shield emblem, the bridge is easy to install with unique headbolt mounts. All necessary mounting hardware included. Sold in pairs.

Fits '04-later XL models.

<b>44296-04</b>	Black Highlighted.	<b>\$51.95</b>
<b>61400176</b>	Solid Black.	<b>\$51.95</b>

## F. HEADBOLT BRIDGE – CHROME

This exclusive Headbolt Bridge covers both the headbolts and spark plug with a splash of chrome and an engraved Bar & Shield emblem. Easy to install with unique headbolt mounts. Kit includes all necessary mounting hardware. Sold in pairs.

<b>44432-04</b>		<b>\$59.95</b>
Fits '04-later XL and XR models.		

## G. SPARK PLUG/HEADBOLT COVER – CHROME

Quickly add a chrome accent from the headbolt covers to the spark plug. Installs in seconds without tools.

<b>43835-98</b>		<b>\$59.95</b>
Fits '84-'99 Evolution® 1340-equipped models and '85-'03 XL models. (Does not fit Screamin' Eagle® Evolution Heads.)		

## H. HEADBOLT COVERS

Precision-machined of high-quality aluminum and manufactured in the U.S.A. Hand-polished and chrome-plated. Available in a variety of styles to match your customizing direction, these kits include 4 easy-to-install headbolt covers, set screws and an Allen® wrench for easy installation.

Fits '86-later XL, '08-'13 XR, '85-'99 Evolution 1340 and '99-later Twin Cam models.

<b>43822-01</b>	Chrome-Billet.	<b>\$42.95</b>
<b>43890-93</b>	Chrome-Die Cut.	<b>\$38.95</b>
<b>43896-99</b>	Gloss Black.	<b>\$41.95</b>

## I. CLUTCH CABLE CONNECTOR COVER

Add the finishing touch to your transmission. This chrome-plated die-cast cover conceals the clutch cable connector as it enters the primary cover. The two-piece grooved and tapered cover is easy to install and includes chrome-plated mounting hardware.

<b>33401-05</b>		<b>\$29.95</b>
Fits '00-later XL and XR models with cable-operated clutch.		



**F. HEADBOLT BRIDGE – CHROME**



**G. SPARK PLUG/HEADBOLT COVER – CHROME**



**H. HEADBOLT COVERS – CLASSIC CHROME**



**H. HEADBOLT COVERS – GLOSS BLACK**



**I. CLUTCH CABLE CONNECTOR COVER**



*Notice: The prices appearing in this catalog are the manufacturer's suggested retail prices. Actual retail prices may vary.*



# 124 SPORTSTER®

## Chassis Trim

### A. RIGHT SIDE OIL TANK COVER – CHROME

Like oil on blacktop, this Chrome Oil Tank Cover adds a brilliant sheen to the surface. Easy to install, the mirror-chrome cover follows the contour of the frame and blends perfectly with the pop-up dipstick. A perfect complement for the Chrome Left Side Battery Cover P/N 66261-04.

**66262-04** Fits '04-'13 XL models. **\$114.95**

### B. LEFT SIDE BATTERY COVER – CHROME

Designed to hug the contour of the frame, this mirror-chrome Battery Cover layers a splash of chrome to the left side of the bike. Easy to install, this cover is the ideal companion to the Chrome Oil Tank Cover P/N 66262-04.

**66261-04** Fits '04-'13 XL models. **\$114.95**

### C. SIDE COVER WING TIPS

Formed to hug the contour of the Sportster® Side Covers, the kit features three-dimensional trim with contrasting bright and brushed finishes for a distinctive appearance. A classic addition to painted or chrome side covers. Self-adhesive and easy to install, the kit includes left and right trim pieces.

**66264-04** Fits '04-'13 XL models. **\$39.95**

### D. OIL TANK COVER – CHROME

Chrome Oil Tank Cover gives the appearance of having your oil tank chromed. Installs in minutes. Mounting hardware included.

**62512-97** **\$84.95**  
Fits '94-'03 XL models (except models with Touring Seat P/N 52105-93, 52105-93A, 52105-93B and 52105-93C).

### E. IGNITION MODULE COVER – CHROME

**66328-82T** Fits '82-'03 XL models. **\$27.95**

### F. BATTERY SIDE COVER – CHROME

This chrome-plated cover is designed for use with the Harley-Davidson® AGM sealed maintenance-free batteries and can be used in combination with Battery Top Cover P/N 66367-97 or 66368-97.

**66718-01** **\$49.95**  
Fits '97-'03 XL models and '97-'05 Dyna® models.

### G. BATTERY COVERS – CHROME\*

Chrome-plated battery enclosures include slotted openings for convenient visual check of battery fluid levels. Easy installation.

**1. 66340-78** Chrome Vented. **\$49.95**  
Fits '82-'03 XL models, electric start FX, FXWG models and '91-'96 Dyna models.

**2. 66358-83** U.S.A. Eagle. **\$59.95**  
Fits '82-'03 XL models, electric start FX, FXWG models and '91-'96 Dyna models.

**3. 66367-97** Top Cover. **\$29.95**  
Fits '97-'03 XL models.

\*NOTE: Battery dimensions of Harley-Davidson AGM Batteries P/N 65989-97A, 65989-90B and 65991-82B may not allow use of accessory battery side covers on XL and Dyna models.



A. RIGHT SIDE OIL TANK COVER – CHROME



B. LEFT SIDE BATTERY COVER – CHROME



C. SIDE COVER WING TIP



D. OIL TANK COVER – CHROME



E. IGNITION MODULE COVER – CHROME



F. BATTERY SIDE COVER – CHROME



G. BATTERY COVERS – CHROME

Notice: The prices appearing in this catalog are the manufacturer's suggested retail prices. Actual retail prices may vary.

# SPORTSTER® 125

Oil Coolers



H. PREMIUM OIL COOLER KIT



H. PREMIUM OIL COOLER KIT

## H. PREMIUM OIL COOLER KIT

This oil cooler was designed specifically for Harley-Davidson® to out-perform all other coolers in the industry. The cooler features a unique "Turbulator" system that evenly distributes oil across the cooling chambers. The air fins are designed to efficiently dissipate heat. The oil cooler has been designed to simplify installation and enhance performance. Kit comes complete with mounting hardware and pre-cut oil lines.

**62700082** Side-Mount. **\$299.95**  
Fits '04-later XL models. Does not include an integrated thermostat.

## I. OIL COOLER COVER – SPORTSTER®

Add a beautiful accent to your Sportster® Premium Oil Cooler. This chrome cover is designed to allow proper airflow through the integrated duct work. Requires Grey Silicone RTV Adhesive P/N 99650-02 for installation.

**63087-07** **\$49.95**  
Fits '04-later XL models equipped with Premium Oil Cooler Kit P/N 62996-07A or 62700082.



I. OIL COOLER COVER – SPORTSTER

## J. OIL LEVEL AND TEMPERATURE DIPSTICK WITH LIGHTED LCD READOUT

No more grabbing a rag to pull your hot dipstick. No more oil drips on your pipes and on the garage floor. These stylish yet hard-working dipsticks allow you to check your oil level and oil temperature with the push of a button. Simply push the button and this dipstick lights up with a brilliant backlight. Oil level is indicated by a four-segment readout – it even reminds you to check your oil when it is hot. Capacitive level sensing technology provides the highest degree of accuracy and durability. The waterproof LCD (liquid crystal display) readout operates on a long-lasting, replaceable lithium coin-type battery (CR2032 3V, P/N 66000107). Display features a low battery indicator and press-and-hold feature to toggle between Fahrenheit and Celsius.

Fits '04-later XL and XR models.

**62700009** Chrome. **\$149.95**  
**62700011** Gloss Black. **\$149.95**

## K. OIL DIPSTICK WITH TEMPERATURE GAUGE

Replace your Original Equipment oil dipstick with this custom-styled version featuring an easy-to-see mechanical temperature readout with "Harley-Davidson" logo. A chrome-plated cap completes the styling and provides an easy grip for removal.

**63023-05** Fits '04-later XL and XR models. **\$59.95**  
**62667-87TA** Fits '82-'03 XL models. **\$34.95**



J. OIL LEVEL AND TEMPERATURE DIPSTICK WITH LIGHTED LCD READOUT – CHROME



J. OIL LEVEL AND TEMPERATURE DIPSTICK WITH LIGHTED LCD READOUT – GLOSS BLACK



K. OIL DIPSTICK WITH TEMPERATURE GAUGE – '04-LATER SPORTSTER



K. OIL DIPSTICK WITH TEMPERATURE GAUGE – '82-'03 SPORTSTER

Notice: The prices appearing in this catalog are the manufacturer's suggested retail prices. Actual retail prices may vary.

SPORTSTER



# 126 SPORTSTER®

## Chassis Trim & Horns

### A. FLUSH-MOUNT FUEL CAPS

Emphasize the long and lean look of the fuel tank. This Flush-Mount Fuel Cap Kit offers a pop-up filler design that replaces the Original Equipment twist-on fuel cap. A simple push and the fuel filler cap pops up to provide ample grip, even while wearing gloves. Easy to install, the cap assembly screws into position and the self-adhesive decorative ring finishes the look. Complete kit includes screw-in mount, pop-up cap and matching trim ring.

Fits '98-later XL models equipped with 3.3 gal (12.5 L) fuel tank.

<b>63133-10A</b>	Chrome.	<b>\$79.95</b>
<b>63134-10A</b>	Gloss Black.	<b>\$79.95</b>

Fits '98-later XL models equipped with 2.1 gal (7.9 L) or 4.5 gal (17.0 L) fuel tank. Does not fit '04-'10 XL1200C models.

<b>63139-10A</b>	Chrome.	<b>\$79.95</b>
<b>63140-10A</b>	Gloss Black.	<b>\$79.95</b>



A. FLUSH-MOUNT FUEL CAP – CHROME



A. FLUSH-MOUNT FUEL CAP – GLOSS BLACK

### B. LOUD HORN KIT

Grab everyone's attention. Engineered to be 3dB louder (at 2 meters) than the Original Equipment front-mounted horn, this Horn Kit is tuned to a frequency that helps cut through the background noise. Designed to be a plug-in replacement for the factory horn, this easy-to-install option is available in your choice of brilliant chrome or gloss black finish. The traditional Bar & Shield logo adds a classic finishing touch.

Fits '96-later XL and XR models with front-mount horn.

<b>69000007</b>	Chrome.	<b>\$29.95</b>
<b>69000009</b>	Gloss Black.	<b>\$29.95</b>



B. LOUD HORN KIT – CHROME



B. LOUD HORN KIT – GLOSS BLACK

### C. SIDE-MOUNT HORN KIT – CHROME

Convert your stock Sportster® horn to the look of a Big Twin.

<b>69112-95E</b>		<b>\$94.95</b>
------------------	--	----------------

Fits '92-later XL883, XL883H, XL883C, XL883L, XL883N, XL833R, XL1200, XL1200L, XL1200N, XL1200R, XL1200V, XL1200X and '08-'13 XR models.



C. SIDE-MOUNT HORN KIT – CHROME

### D. IGNITION SWITCH COVER – CHROME

A direct replacement for the stock black ignition switch cover, this chrome-plated cover is made of lightweight ABS plastic. Includes ignition switch position decal.

<b>71527-04</b>	Fits '04-'13 XL models.	<b>\$21.95</b>
<b>71514-98</b>	Fits '95-'03 XL models.	<b>\$19.95</b>



D. IGNITION SWITCH COVER – CHROME

### E. BAR & SHIELD LOGO COIL COVER KIT

Dress your coil in chrome. The sleek Coil Cover is styled to add a custom touch to a very visible part of your Sportster motorcycle. Featuring mirror-finish chrome-plating and an open-face Bar & Shield logo, this easy-to-install kit includes chrome-plated mounting hardware.

<b>31767-04</b>	Fits '04-'06 XL models.	<b>\$39.95</b>
-----------------	-------------------------	----------------



E. BAR & SHIELD LOGO COIL COVER KIT

### F. VOLTAGE REGULATOR COVER

With a look that creates its own electricity, this chrome-plated cover features an embossed Bar & Shield logo and an open-center grill that allows air to flow through for regulator cooling. Designed for easy installation. Chrome mounting hardware included.

<b>74609-04</b>	Fits '04-'06 XL models.	<b>\$44.95</b>
<b>74579-97</b>		<b>\$44.95</b>

Fits '85-'03 XL models. Will not fit with Front Spoiler P/N 58597-97, unless also equipped with the Sport Front Fender and the additional purchase of Voltage Regulator Hardware Kit P/N 74568-98.



F. VOLTAGE REGULATOR COVER

Notice: The prices appearing in this catalog are the manufacturer's suggested retail prices. Actual retail prices may vary.

# SPORTSTER® 127

Chassis Trim



**G. SIDE-MOUNT LICENSE PLATE KIT – CHROME**

**G. SIDE-MOUNT LICENSE PLATE KIT – BLACK**

## G. SIDE-MOUNT LICENSE PLATE KIT

Add a clean, custom look to the rear fender. This stylish kit moves the license plate from the fender to a side-mount location, visually lowering the bike's profile and opening up the view of the rear end. This strut-mounted hinged frame conceals the license mounting hardware and features a smooth back that hides the unfinished side of the plate. Kit includes LED license plate illumination and a curved Bar & Shield medallion, shaped to conceal the original license mounting holes in the fender. Purchase of tail lamp without license illumination window is recommended for models with center-mounted tail lights.

**NOTE:** License plate location and fold-away feature is regulated in many areas. Check local laws before installation.

Fits '04-later XL models (except XL1200T). Will not fit some International Specification '14-later XL883N (Iron 883) models with Original Equipment LED Turn Signals. See your dealer for details. Will not fit models equipped with rigid mount saddlebags, rigid mount sissy bars and Turn Signal Relocation Kit P/N 68732-02A and 68733-02A.

<b>60947-10</b>	Chrome.	<b>\$199.95</b>
<b>60972-10</b>	Black.	<b>\$199.95</b>

## H. CHOPPED REAR FENDER KIT\*

Complete "bolt-on" fender kit includes everything you need to convert your '04-later Sportster® model to the chopped rear fender look. Available in Vivid Black or Primed finish, this kit can be installed with simple tools and requires no frame modifications or fabrication. The chopped fender eliminates the traditional tail lamp and replaces the Original Equipment rear turn signals with "stop-turn-tail" lights for a clean, stripped-down appearance. All you need to add is a side mount or under-fender mount license plate bracket (sold separately).

**NOTE:** Laws regarding the location of the license plate vary from place to place. Please check with local authorities and obey all applicable laws and regulations.

Fits '07-'09 XL models (stock on XL1200N and XL883N). Requires separate purchase of Side Mount License Plate Assembly P/N 60318-07.

<b>60236-09BEO</b>	Primed.	<b>\$419.95</b>
<b>60236-09DH</b>	Vivid Black.	<b>\$499.95</b>

Fits '04-'06 and '10-later XL models (except XL1200T). Stock on XL1200V, XL1200X, XL1200N and XL883N. Will not fit some International Specification '14-later XL883N (Iron 883) models with Original Equipment LED Turn Signals. See your dealer for details. Requires separate purchase of Side Mount License Plate Assembly P/N 60318-07, 60947-10 or 60972-10.

<b>60236-10BEO</b>	Primed.	<b>\$419.95</b>
<b>60236-10DH</b>	Vivid Black.	<b>\$499.95</b>



**H. CHOPPED REAR FENDER KIT (CUSTOM PAINTED)**

## I. CHOPPED FENDER EDGE LIGHT

Style and function in one. This center-mount running and brake light commands the attention of following vehicles. The bright, fast-acting LED lamp glows red when the ignition is on and intensifies when the brakes are applied. The low-profile lamp is contoured to hug the curve of the chopped rear fender and adds a stylish touch of color, even when the bike is parked.

**68000105** Red Lens. **\$99.95**

Fits '14-later XL883N, XL1200V, XL1200X and '14-later models equipped with Chopped Rear Fender Kit P/N 60236-XX and side-mount license plate. Will not fit models with center-mount license plates.

**73420-11** Red Lens. **\$89.95**

Fits '04-'13 XL883N, XL1200N, XL1200V, XL1200X and models equipped with Chopped Rear Fender Kit P/N 60236-XX and side-mount license plate. Will not fit models with center-mount license plates.



**H. CHOPPED REAR FENDER KIT**



**I. CHOPPED FENDER EDGE LIGHT**

\*NOTE: This product is a "Paint to Order" accessory. Please allow for an average of 5 weeks delivery for this item.

Notice: The prices appearing in this catalog are the manufacturer's suggested retail prices. Actual retail prices may vary.



GENUINE MOTOR PARTS &amp; ACCESSORIES



2015

# DYNA®

As a direct descendant of the original "factory custom" motorcycles, the Dyna® family delivers the purest kind of inspiration. No boundaries. No expectations. No rules. And nowhere to go but to the limits of your imagination.





DYNA®

**STREET BOB®**

FXDB | PRODUCTION COLOR: AMBER WHISKEY

Narrow satin black Chizeled handlebar\*. Small Bullet headlamp. Jet black Screamin' Eagle® Street Performance mufflers. Brushed nickel Silencer controls. Distressed leather and brass bobber solo saddle. Can you say "bad-ass"? This Street Bob® motorcycle has everything you need to make a big, bold statement. And nothing that you don't.

SEE WHAT'S ON THIS BIKE AT [H-D.COM/GALLERY](https://www.harley-davidson.com/gallery)

\*Handlebar height is regulated in many areas. Check local laws before installing.





DYNA®

**LOW RIDER®**

FXDL | PRODUCTION COLOR: DEEP JADE PEARL

Deep Jade paint and the perfect balance of black and chrome transform the look of this elegant Low Rider® model. The gloss black front end, Chisel air cleaner, and jet black Nightstick exhaust complement the bike's factory black and silver detailing, and the adjustable handlebar and removable seat pad accommodate a wide range of rider sizes.

SEE WHAT'S ON THIS BIKE AT [H-D.COM/GALLERY](https://www.harley-davidson.com/gallery)





DYNA®

## FAT BOB®

FXDF | PRODUCTION COLOR: MYSTERIOUS RED SUNGLO

No question, this Fat Bob® motorcycle was born to brawl. Its Dark Custom™ soul runs deep – from the gloss black fender struts and brake rotors to the Ventilator Elite air cleaner cover and Screamin' Eagle® exhaust. And the hard-hitting machined highlights of the Black Fin engine trim and Burst Collection foot controls make a big visual impact.

SEE WHAT'S ON THIS BIKE AT [H-D.COM/GALLERY](https://www.harley-davidson.com/gallery)





DYNA®

## WIDE GLIDE®

FXDWG | PRODUCTION COLOR: BLACK QUARTZ WITH FLAMES

A Wide Glide® motorcycle just wouldn't be the same without flames and chrome. It starts with the flamed Black Quartz tank and runs all the way down to the Flame Collection footpegs, shifter peg, and brake pedal. The chrome Bullet headlamp and Street Slammer Bar keep things lean, while the chrome Thunderstar™ wheels keep the heat set on high.

SEE WHAT'S ON THIS BIKE AT [H-D.COM/GALLERY](https://www.harley-davidson.com/gallery)



DYNA®

**SWITCHBACK™**

FLD | PRODUCTION COLOR: VIVID BLACK

Presenting a true touring powerhouse. Outfitted with a narrow beach bar, Rallyrunner® seat and passenger backrest, this machine is ready to rack up the miles. And while all that chrome brightens up the day, you're ready to fight back the night with Daymaker™ Reflector LED headlamps, auxiliary lamps, and fog lamps to light the way.





LOW RIDER® TRANSFORMATION

The latest in a long line of customs, the Low Rider® model honors its legendary heritage with black-highlighted accents, a '70s inspired seat, and unmistakable sculpted 2-into-1 exhaust.

HIGH STYLE

Of course, true lovers of the Low Rider® model legend will still want to make it something to call their own. It starts with a dark and seductive Black Magic paint that plays off the abundant chrome highlights—from the short sissy bar to the Teardrop floating brake rotors—for a shine that just

can't be missed. The Daymaker™ LED headlamp and LED turn signals and tail lamp make sure you draw needed attention at night, and the lightly smoked Quick Release Compact Windshield will cut through the breeze, but comes off in seconds when you'd rather feel the wind in your face.



SHORT PASSENGER BACKREST

SCREAMIN' EAGLE® VENTILATOR AIR CLEANER

QUICK RELEASE COMPACT WINDSHIELD

SLIPSTREAM HAND CONTROLS

DAYMAKER™ LED HEADLAMP

CHROME AXLE NUT COVERS

TEAR DROP POLISHED ROTOR

LED TAIL LAMP & TURN SIGNALS

CHROME SWINGARM & AXLE COVERS

SCREAMIN' EAGLE® NIGHTSTICK MUFFLERS

CHROME ENGINE COVERS

SLIPSTREAM FOOT CONTROLS



FIT

Featuring a unique handlebar riser that provides 2.4" of adjustment and an innovative seat design that allows 1.5" of fore-aft movement, the Low Rider® model will fit almost any rider. Sit down, grab ahold, and take off.



FUNCTION

So what if Sturgis is 1,200 miles away. With a detachable windshield, a backrest, and some soft touring luggage on the passenger pillion, this Low Rider® model is ready to comfortably chew up the miles. And when you get there, strip off the gear and hit the town.



CARE AND MAINTENANCE

While it's tempting to use standard "auto parts store" cleaning and service supplies, hold out for the real thing. Genuine Harley-Davidson® coolant, oils, filters, batteries and service parts are engineered for the unique surfaces and operating conditions your Harley® motorcycle will encounter.



DAYMAKER™ LED HEADLAMP



SCREAMIN' EAGLE® VENTILATOR AIR CLEANER



STYLE

Dipped in chrome, this fully loaded Low Rider® model grabs your attention and doesn't let go. From the chrome hand controls and engine trim to the chrome swingarm and layback license plate, this bike is the definition of the long and lean look.



PERFORMANCE

The low profile Screamin' Eagle® Ventilator exposed element air cleaner provides increased airflow to boost the power, and the 2-into-1 Screamin' Eagle® Nightstick muffler provides the deep-throated rumble we are famous for.



CRAFTSMANSHIP

We design and build the bikes, so we don't need to "reverse-engineer" parts to try and make them fit. Everything we make is rigorously tested to ensure it meets our high standards, and the finishes of our accessories match the bike's surfaces for a consistent appearance.



LED TAIL LAMP & TURN SIGNALS



QUICK RELEASE COMPACT WINDSHIELD

Parts list available at [h-d.com/gallery](http://h-d.com/gallery)

# 142 DYNA®

## Windshields

### A. QUICK-RELEASE SUPER SPORT WINDSHIELD

Reduces the pounding of wind and shower of bugs, but keeps the wind-in-the-hair feeling. Ideal for a cool morning ride, the sleek profile of the Super Sport Windshield hugs the front headlamp for a sporty look. The windshield mounts to the fork tubes with elegant die-cast lever locking clamps, so the windshield does not require any "leave-behind" docking hardware. You get quick on-and-off convenience and a clean, custom look. No tools are required and the kit includes everything needed to install the windshield.

**57300-06** 19" Light Smoke. **\$349.95**  
Fits '06-later Dyna® models (except FLD, FXDWG, FXDF and FXDSE). Windshield dimensions: Overall height – 25.0"; width – 20.1".

**57301-06** 19" Light Smoke. **\$349.95**  
Fits '06-later FXDWG and '13-later FXSB and FXSBSE models. Windshield dimensions: Overall height – 25.0"; width – 20.1".

**57331-07** 16" Light Smoke. **\$359.95**  
Fits '07-'08 FXDSE and '00-later FXST, FXSTB and FXSTC models equipped with Custom Inverted Front Fork Kit P/N 46321-05, 46321-05A or 48646-06. Windshield dimensions: Overall height – 22.1"; width – 15.3".

**57838-08** 19" Light Smoke. **\$324.95**  
Fits '88-later XL (except XL1200T, XL1200X, '11-later XL883L and XL1200C) and '91-'05 Dyna models (except FXDWG and FXDXT). XL Custom models require Front Directional Relocation Kit P/N 68517-94A. Windshield dimensions: Overall height – 25.0"; width – 20.1".

### B. H-D® DETACHABLES™ SUPER SPORT WINDSHIELD

Super is an apt description for this do-it-all windshield with detachable convenience and sport styling. The windshield mounts to the fork tubes with H-D® Detachables™ Docking Hardware (sold separately) for easy on-and-off convenience and a quick return to a sporting profile.

**57965-97A** 18" Light Smoke. **\$229.95**  
Fits '84-later FXST, FXSTC, FXSTB, '93-'05 FXDWG, '80-'86 FXWG. (Does not fit FXSTD.) Use Docking Hardware Kit P/N 58350-96. Windshield dimensions: Overall height – 22.3"; width – 17.8".

#### Shown with:

#### DOCKING HARDWARE FOR H-D DETACHABLES WINDSHIELDS

**58164-96A** For 39mm Forks. **\$79.95**  
Required for installation of H-D Detachables Windshields on '88-later XL (except XL1200X, '11-later XL883L and XL1200C) and '91-'05 Dyna models (except FXDWG and FXDXT). XL and Dyna models with Front Turn Signals originally located on the upper triple clamp may require the additional purchase of Turn Signal Wiring Kit P/N 72389-96.

**58350-96** For 41mm Forks. **\$79.95**  
Required for installation of H-D Detachables Windshields on '84-later FXST, FXSTC, FXSTB, '93-'05 FXDWG, '80-'86 FXWG models. (Does not fit FXSTD.)

### C. SPORT WINDSHIELD KIT

Formed of polycarbonate and hard-coated to resist scratching. Light smoke windshield is contoured to fit the headlamp and incorporates adjustable four-point mounting. Functional styling helps deflect wind to reduce upper body fatigue.

**58192-87A** 18" Light Smoke. **\$164.95**  
Fits '88-later XL (except XL Custom, XL1200T, XL1200X and '11-later XL883L) and '95-'05 Dyna models (except FXDWG and FXDXT). Includes black mounting hardware. Windshield dimensions: Overall height – 18.5"; width – 16.3".

**91820-85A** 18" Light Smoke. **\$164.95**  
Fits '84-later FXST, FXSTB, FXSTC, '93-'05 FXDWG and '86-earlier FXWG models. Windshield dimensions: Overall height – 20.0"; width – 15.0".

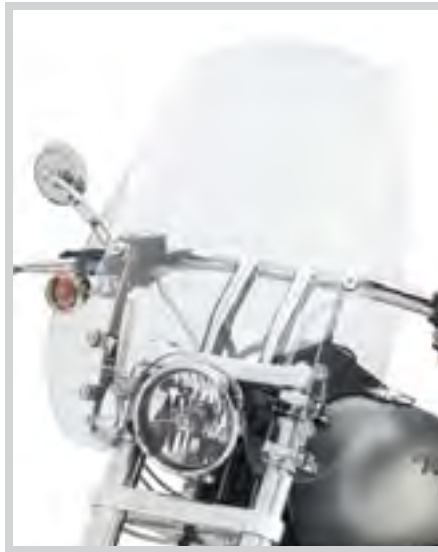

A. QUICK-RELEASE SUPER SPORT WINDSHIELD (57300-06 SHOWN)



A. QUICK-RELEASE SUPER SPORT WINDSHIELD (57838-08 SHOWN)



A. QUICK-RELEASE SUPER SPORT WINDSHIELD (57331-07 SHOWN)



A. QUICK-RELEASE SUPER SPORT WINDSHIELD (57838-08 SHOWN)



B. H-D DETACHABLES SUPER SPORT WINDSHIELD



C. SPORT WINDSHIELD KIT (58192-87A SHOWN)



# DYNA® 143

## Windshields

### D. QUICK-RELEASE COMPACT WINDSHIELD

Combine the classic Harley-Davidson® windshield shape with a revolutionary new attachment system and you have the best of style and function. The windshield mounts to the fork tubes with elegant die-cast lever-release clamps, so the windshield does not require any "leave-behind" docking hardware. You get quick on-and-off convenience and a clean, custom look. No tools are required and the kit includes everything needed to install the windshield. The tough, hard-coated polycarbonate windshield is available in your choice of traditional polished or gloss black horizontal and vertical braces.

Fits '06-later Dyna® models (except FLD, FXDWG, FXDF and FXDSE).

**58346-06** 18" Clear – Polished Braces. **\$369.95**

Windshield dimensions: Overall height – 26.8"; width – 19.7".

**58347-06** 18" Light Smoke – Polished Braces. **\$389.95**

Windshield dimensions: Overall height – 26.8"; width – 19.7".

**58348-06** 14" Light Smoke – Polished Braces. **\$384.95**

Windshield dimensions: Overall height – 22.8"; width – 19.5".

Fits '06-later FXDWG and '13-later FXSB and FXSBSE models.

**58387-06** 18" Clear – Polished Braces. **\$369.95**

Windshield dimensions: Overall height – 26.8"; width – 19.5".

**58413-06** 18" Light Smoke – Polished Braces. **\$389.95**

Windshield dimensions: Overall height – 26.8"; width – 19.5".

**58444-06** 14" Light Smoke – Polished Braces. **\$389.95**

Windshield dimensions: Overall height – 22.8"; width – 19.5".

Fits '08-later FXDF and FXDFSE models.

**57338-08** 19" Clear – Polished Braces. **\$369.95**

Windshield dimensions: Overall height – 27.0"; width – 19.6".

**58617-09** 19" Clear – Black Braces. **\$389.95**

Windshield dimensions: Overall height – 27.0"; width – 19.6".

**57340-08** 15" Light Smoke – Polished Braces. **\$389.95**

Windshield dimensions: Overall height – 23.0"; width – 19.6".

**58630-09** 15" Light Smoke – Black Braces. **\$409.95**

Windshield dimensions: Overall height – 23.0"; width – 19.6".

Fits '88-later XL (except XL1200T, XL1200X, '11-later XL883L and XL1200C) and '91-'05 Dyna models (except FXDWG and FXDXT).

**58063-04** 18" Clear – Polished Braces. **\$369.95**

Windshield dimensions: Overall height – 26.8"; width – 19.7".

**58706-09** 18" Clear – Black Braces. **\$389.95**

Windshield dimensions: Overall height – 26.8"; width – 19.7".

**58601-04** 18" Light Smoke – Polished Braces. **\$399.95**

Windshield dimensions: Overall height – 26.8"; width – 19.7".

**58602-04** 14" Light Smoke – Polished Braces. **\$389.95**

Windshield dimensions: Overall height – 22.8"; width – 19.5".

**58703-09** 14" Light Smoke – Black Braces. **\$419.95**

Windshield dimensions: Overall height – 22.8"; width – 19.5".

Fits '93-'05 FXDWG and '86-later FXST, FXSTC and FXSTB models.

**59802-05** 19" Clear – Polished Braces. **\$429.95**

Windshield dimensions: Overall height – 23.8"; width – 21.4".

**58360-09** 19" Clear – Black Braces. **\$459.95**

Windshield dimensions: Overall height – 23.8"; width – 21.4".

**58751-05** 19" Light Smoke – Polished Braces. **\$449.95**

Windshield dimensions: Overall height – 23.8"; width – 21.4".

**57199-05** 16" Light Smoke – Polished Braces. **\$439.95**

Windshield dimensions: Overall height – 20.8"; width – 21.4".

**58376-09** 16" Light Smoke – Black Braces. **\$469.95**

Windshield dimensions: Overall height – 20.8"; width – 21.4".

#### Also available:

#### TURN SIGNAL RELOCATION KIT

Styled to blend with the lower triple clamp. This chrome-plated Turn Signal Relocation Kit moves the Original Equipment bullet-style turn signals from the handlebar to the front fork for a clean, streamlined look. Kit includes left and right mounting stalk and all required hardware.

**69433-08A** **\$89.95**

Fits '08-later Dyna models (except FLD and FXDSE/2).

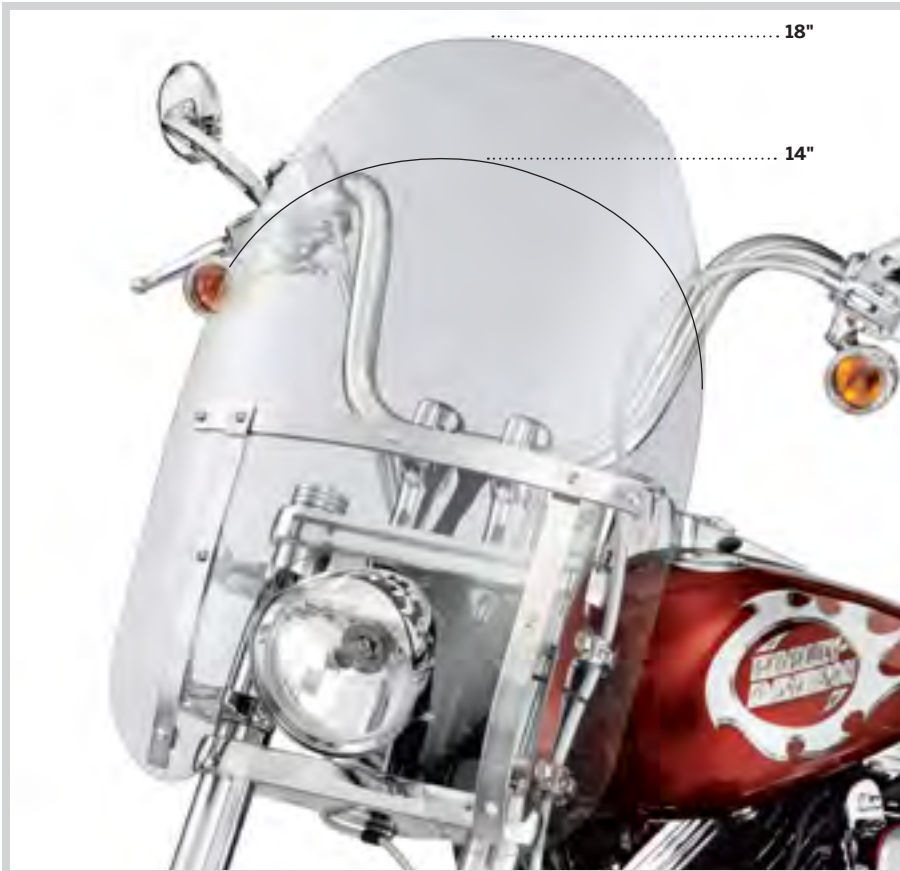

D. QUICK-RELEASE COMPACT WINDSHIELD – POLISHED BRACES



D. QUICK-RELEASE COMPACT WINDSHIELD – 15", GLOSS BLACK BRACES (SHOWN WITH TURN SIGNAL RELOCATION KIT)

DYNA

Notice: The prices appearing in this catalog are the manufacturer's suggested retail prices. Actual retail prices may vary.

# 144 DYNA®

Windshields

## A. H-D® DETACHABLES™ TALL WINDSHIELD – SWITCHBACK™

Get maximum protection from the wind. The detachable shield can be removed and reinstalled in seconds to tailor your bike to different riding conditions.

**57400120** 20" Clear. **\$349.95**

Fits '12-later FLD models. Windshield dimensions: Overall height – 27.0"; width – 24.0".

## B. H-D DETACHABLES COMPACT WINDSHIELD FOR MODELS WITH AUXILIARY LIGHTING

Whether it's for keeping bugs off your face or warmth in your body, a windshield has a huge impact on rider and passenger comfort. By diverting air pressure past your chest and over your helmet, a windshield can add hours of riding comfort. This high-quality polycarbonate windshield mounts to the fork tubes with detachable Docking Hardware for easy on-and-off convenience and a quick return to a stripped-down profile and is shaped to fit models equipped with Auxiliary Lighting Kits.

**57609-08** 18" Clear. **\$389.95**

Fits '06-later Dyna® models (except FLD, FXDWG, FXDSE, FXDF and '14-later FXDL) equipped with Auxiliary Lighting Kits. Includes Quick-Release Docking Hardware. Windshield dimensions: Overall height – 26.8"; width – 19.7".

**57716-01** 18" Clear. **\$289.95**

Fits '88-later XL (except XL1200T, XL1200X, '11-later XL883L and XL1200C) and '91-'05 Dyna models (except FXDWG and FXDXT) equipped with Auxiliary Lighting Kits. Requires the separate purchase of Docking Hardware Kit P/N 58164-96A and Turn Signal Relocation Kit P/N 68603-01. Windshield dimensions: Overall height – 26.8"; width – 19.7".

**58865-03** 18" Clear. **\$299.95**

Fits '93-'05 FXDWG and '84-later FXST, FXSTC, FXSTB models equipped with Auxiliary Lighting Kits. Requires separate purchase of Docking Hardware Kit P/N 58361-03. Windshield dimensions: Overall height – 21.9"; width – 21.4".

### Also available:

#### TURN SIGNAL RELOCATION KIT

This kit relocates the turn signals to the passing lamp bracket and allows the use of a detachable windshield. Kit includes all necessary hardware required for installation.

**68603-01** **\$49.95**

Fits '88-later XL (except XL1200T), '91-'05 Dyna and '84-later FXS, FXST, FXSTC and FXSTB Softail® models equipped with Auxiliary Lighting Kits.

### Also available:

#### WINDSHIELD DOCKING HARDWARE AND TURN SIGNAL RELOCATION KIT

Required for installation of H-D® Detachables™ Windshields on FXDWG and FXST models equipped with Auxiliary Lighting Kits. Includes windshield mounting hardware and turn signal relocation hardware.

**58361-03** **\$89.95**

Fits '93-'05 FXDWG and '84-later FXST, FXSTC, FXSTB models equipped with Auxiliary Lighting Kits.

### Also available:

#### TURN SIGNAL RELOCATION KIT

Styled to blend with the lower triple clamp. This chrome-plated Turn Signal Relocation Kit moves the Original Equipment bullet-style turn signals from the handlebar to the front fork for a clean, streamlined look. Kit includes left and right mounting stalk and all required hardware.

**58742-05** **\$59.95**

Fits '93-'05 FXDWG, '86-later FXST, FXSTC, FXSTB and '00-'07 FXSTD models.



A. H-D DETACHABLES TALL WINDSHIELD – SWITCHBACK



B. H-D DETACHABLES COMPACT WINDSHIELD FOR MODELS WITH AUXILIARY LIGHTING

*Notice: The prices appearing in this catalog are the manufacturer's suggested retail prices. Actual retail prices may vary.*





**C. VENTILATOR QUICK-RELEASE COMPACT WINDSHIELD**

**C. VENTILATOR QUICK-RELEASE COMPACT WINDSHIELD**

In a nutshell, a windshield should provide a barrier between the rider and errant bugs, discarded cigarette butts, flying debris and bad air. The shield should manage airflow and wind blasts to create a pocket of still air for both rider and passenger comfort. But if you ride in a warm climate or spend time at low speeds stuck in traffic, you need to keep some air circulating around your body to stay comfortable. The Ventilator Windshield features clear injection-molded vents that allow you to adjust the airflow to match the riding conditions. Opening the vents redirects the air across your chest for a cooling effect and closing the vents provides maximum wind and weather protection. But when you want to ride "naked," the detachable shield can be removed completely and reinstalled in seconds to match your riding mood.

**57400025** 19" Clear. **\$429.95**  
 Fits '88-later XL (except XL1200T, XL1200X, '11-later XL883L and XL1200C) and '91-'05 Dyna® models (except FXDWG and FXDXT). Windshield dimensions: Overall height – 28.0"; Overall width – 21.4".

**57400026** 19" Clear. **\$429.95**  
 Fits '06-later Dyna models (except FLD, FXDF, FXDWG and FXDSE). Windshield dimensions: Overall height – 28.0"; Overall width – 21.4".

**57400028** 20" Clear. **\$479.95**  
 Fits '93-'05 FXDWG and '86-later FXST, FXSTC and FXSTB models. Windshield dimensions: Overall height – 24.8"; Overall width – 21.3".

**D. QUICK-RELEASE TOURING WINDSHIELD**

The Touring Windshield features an aerodynamic design shaped to provide hours of riding comfort. The additional center width directs airflow past the hand grips and deflects rain and road debris around the rider. The windshield mounts to the fork tubes with elegant die-cast lever-release clamps, so the windshield does not require any "leave-behind" docking hardware. You get quick on-and-off convenience and a clean, custom look. No tools are required and the kit includes everything needed to install the windshield. The tough, hard-coated polycarbonate windshield features traditional polished horizontal and vertical braces.

Fits '06-later Dyna models (except FLD, FXDF, FXDWG and FXDSE). Windshield dimensions: Overall height – 26.3"; width – 25.0".

**57015-06** 19" Clear. **\$439.95**

**57016-06** 19" Light Smoke. **\$459.95**

Fits '88-later XL (except XL1200T, XL1200X, '11-later XL883L and XL1200C) and '91-'05 Dyna models (except FXDWG and FXDXT). Windshield dimensions: Overall height – 28.3"; width – 22.1".

**58158-08** 19" Clear. **\$439.95**



**D. QUICK-RELEASE TOURING WINDSHIELD – LIGHT SMOKE**

DYNA

*Notice: The prices appearing in this catalog are the manufacturer's suggested retail prices. Actual retail prices may vary.*

# 146 DYNA®

Windshields

## A. WINDSHIELD ACORN NUT KIT

Kit contains 10 chrome-plated low crown 12-24 acorn nuts.

**94111-95** \$9.95

Fits Compact, King-Size, Convertible and Road King® windshields. (Pkg. of 10.)



A. WINDSHIELD ACORN NUT KIT

## B. LOCKING QUICK-RELEASE WINDSHIELD CLAMPS

Protect your investment. This Locking Quick-Release Windshield Clamp secures your windshield from grab-and-run theft, giving you peace of mind when you have to leave your bike unattended. The chrome-plated locking clamp replaces one of the Original Equipment windshield clamps and features a push-button lock with a mini barrel-style key for easy removal. Kit includes one locking clamp and two matching keys.

**57400006** 39mm. \$39.95

Fits '88-later XL and '91-'05 Dyna® models (except FXDWG) equipped with Quick-Release style detachable windshields.

**57400007** 41mm. \$29.95

Fits '93-'05 FXDWG and '88-later FXS, FXST, FXSTB and FXSTC models equipped with Quick-Release style detachable windshields.

**57400008** 49mm. \$41.95

Fits '02-'10 VRSCA and VRSCAW, '04-'05 VRSCB, '07 VRSCX and '06-later Dyna models (except FLD) equipped with Quick-Release style detachable windshields.



B. LOCKING QUICK-RELEASE WINDSHIELD CLAMP

## C. MID-FRAME AIR DEFLECTOR

Improve rider comfort during the summer riding season. Designed for severe duty and extreme temperature applications, these inconspicuous black deflectors attach to the frame and surround the top of the rear cylinder head. The scoop shape captures the moving air and uses the flow to direct the heat down and away from the rider to improve comfort. Kit includes all required mounting hardware.

**29200011** \$84.95

Fits '06-later Dyna models. '06-'11 models require removal of Original Equipment coil cover and separate purchase of Coil Mounting Screws P/N 4717A (Qty 2). Does not fit with accessory Coil Covers P/N 31709-04 or 74616-04. Does not fit with Digital Oil Pressure Gauge P/N 75138-09 or 75340-09.



C. MID-FRAME AIR DEFLECTOR (DYNA SWITCHBACK SHOWN)

## D. SOFT LOWERS

Extend your riding season. Full coverage Soft Lowers provide wind and mud protection for the rider's legs and boots and minimize cold updrafts as the weather changes. Covers are custom shaped to hug the engine guard to minimize flapping and they simply clip in place for speedy installation as the weather changes. Two-way zippered outer edge accommodates guard-mounted highway pegs in almost any position. Reflective piping provides added visibility and convenient zippered pockets provide additional storage for maps or other small items.

**57100212** \$89.95

Fits '06-later FXD, FXDB, FXDC and FXDL models equipped with Engine Guard P/N 49010-06 or 49320-09. Does not fit models with forward controls or footboards.



## E. TURN SIGNAL RELOCATION KIT

Styled to blend with the lower triple clamp. This chrome-plated Turn Signal Relocation Kit moves the Original Equipment bullet-style turn signals from the handlebar to the front fork for a clean, streamlined look. Kit includes left and right mounting stalk and all required hardware.

**69433-08A** \$89.95

Fits '08-later Dyna models (except FLD and FXDSE/2).



D. SOFT LOWERS



E. TURN SIGNAL RELOCATION KIT

Notice: The prices appearing in this catalog are the manufacturer's suggested retail prices. Actual retail prices may vary.



## SEAT OF POWER

The right seat is equal parts ergonomics and comfort. Its shape anchors your position and determines the reach to the ground and to the controls and the padding supports your tailbone and hips to relieve stress and pressure. Pick the right one for you – and your passenger.

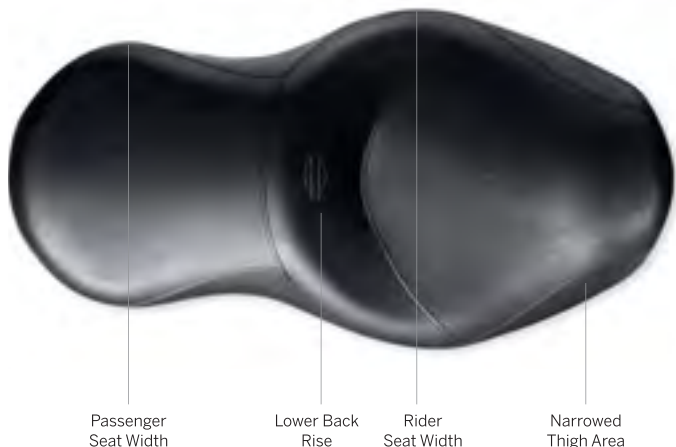

Passenger Seat Width

Lower Back Rise

Rider Seat Width

Narrowed Thigh Area

### PAMPER YOUR BEHIND



Experience ultimate comfort. Road Zeppelin® seats and seat pads are equipped with a unique air bladder system that distributed rider weight across the entire seating surface. By reducing pressure points and providing shock absorption, this pad allows you to ride your cool low-profile seat for hundreds of miles. The mesh cover lets air circulate beneath the rider's body, reducing the temperature between the rider and seat. The easy-to-reach integrated hand pump and air release valve permits quick and convenient adjustment.

### CHANGING YOUR SEAT



Switching out your seat is simple. And because certain rides call for certain styles, some folks like to have multiple seats to match the occasion. Install a comfortable, supportive touring seat for the longer treks and swap it out for a low-profile seat for a night on the town. Please see your owner's manual for proper removal and installation of seats.

### DYNA® SEAT TYPES

Solo or two-up, comfort or style, check out these seats to get an idea of where you want to sit.



#### LOW-PROFILE SEATS

These saddles combine radical styling with a "deep-in-the-bike" riding position. Long and lean, Badlander®, Brawler® and Sidekick® seats bring you lower to the ground than most other seats.



#### POSITION SEATS

Designed to place the rider in the best relationship to the controls, Reach® and Tallboy® seats position short and tall riders for a comfortable extension of the arms and legs.



#### TOURING SEATS

Designed for comfort, Sundowner™ and Signature Series® and other touring seats and passenger pillions offer a broad seating surface to reduce pressure points. The dished shape holds you in place and provides additional back support.

### CUSTOM SEAT PROGRAM

A personalized seat is the perfect thread to tie your bike's attitude together. Select the stitching pattern, leather inlay and thread color that best support your custom movement and you'll have your personalized seat in just three weeks. For more details, turn to page 796 or visit [h-d.com/customseat](http://h-d.com/customseat).



# 148 DYNA®

Seating – Solo

## A. BOBBER SOLO SADDLE

How low can you go? This minimalist solo seat takes the stripped-down garage-built look about as far as you can go. The thick distressed black leather cover is bonded directly to the formed metal seat pan and minimizes the foam filler and the extra height it brings. The raw-edge leather features brass rivets and "Milwaukee Since 1903" trim that will develop a rich patina with use and a Bar & Shield logo burned into the surface. Easy to install, the bolt-on seat and model-specific Spring Seat Installation Kit includes everything you need to get the bobber look. No cutting, welding or fabrication is necessary.

**52000180** Black Distressed Leather. **\$299.95**  
Fits '04-'06 XL, '10-later XL, '06-later Dyna® and '08-later FXS, FLS, FLSTC, FLSTN, FLSTF and FLSTFB models.  
Installation requires separate purchase of model-specific Rigid or Spring Saddle Mounting Hardware Kit.

## B. SOLO SADDLE

Add nostalgic "bobber" looks to your modern Harley-Davidson® motorcycle. Available in elegant leather, this solo seat features a low-profile design that provides the minimalist "just enough to ride" look. The smooth metal seat pan and the simple frame cover leave a clean, finished appearance. Easy to install, the bolt-on seat and model-specific Spring Seat Installation Kit includes everything you need to get the bobber look. No cutting, welding or fabrication is necessary and the seat can be removed and replaced with a touring seat for a two-up night on the town.

Fits '04-'06 XL, '10-later XL, '06-later Dyna and '08-later FXS, FLS, FLSTC, FLSTN, FLSTF and FLSTFB models. Installation requires separate purchase of model-specific Rigid or Spring Saddle Mounting Hardware Kit.

<b>54373-10</b>	Black Leather.	<b>\$299.95</b>
<b>54072-10</b>	Brown Leather.	<b>\$299.95</b>
<b>52000113</b>	White Diamond.	<b>\$299.95</b>
<b>52000114</b>	Black Diamond.	<b>\$299.95</b>

Shown with:

### SPRING SADDLE INSTALLATION KIT

The torsion-style springs are designed for the optimum balance between spring suspension and support. Required for installation of Solo Saddle Kit P/N 54072-10, 54373-10, 52000113, 52000114 and 52000180. Kit includes springs, mounting brackets, frame cover and hardware.

**54075-10** **\$229.95**  
Fits '06-later Dyna models.

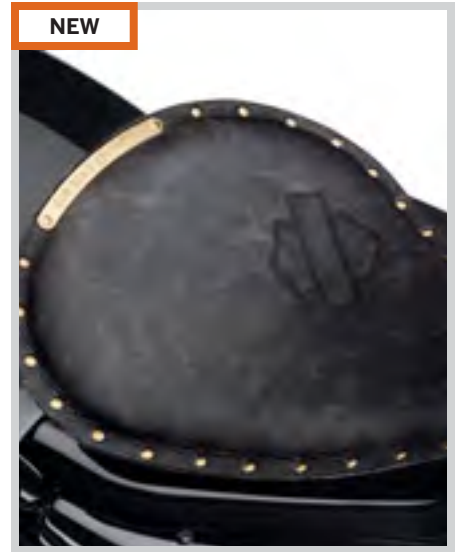

**A. BOBBER SOLO SADDLE – BLACK DISTRESSED LEATHER (SHOWN WITH SPRING SADDLE INSTALLATION KIT)**



**B. SOLO SADDLE – BLACK LEATHER (SHOWN WITH SPRING SADDLE INSTALLATION KIT)**

**B. SOLO SADDLE – BROWN LEATHER (SHOWN WITH SPRING SADDLE INSTALLATION KIT)**

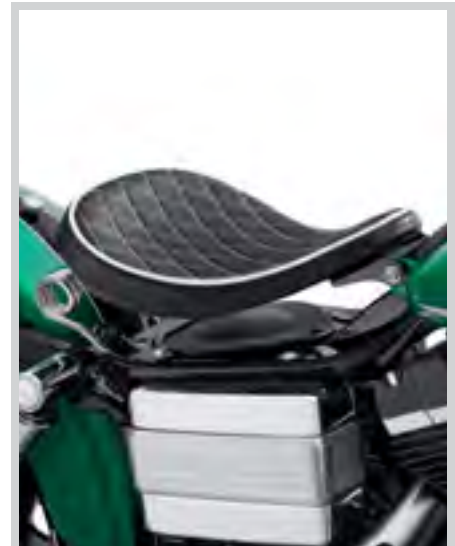
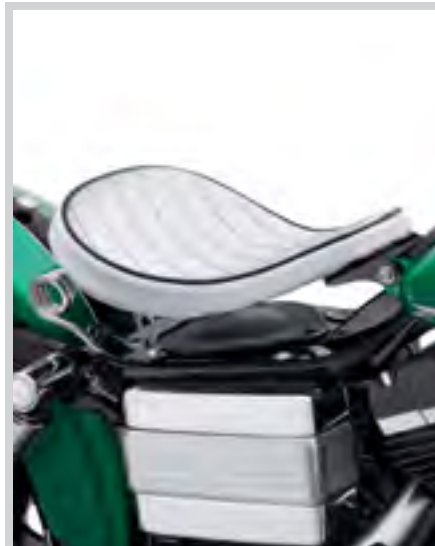

**B. SOLO SADDLE – WHITE DIAMOND (SHOWN WITH SPRING SADDLE INSTALLATION KIT)**

**B. SOLO SADDLE – BLACK DIAMOND (SHOWN WITH SPRING SADDLE INSTALLATION KIT)**

Note: Some Harley-Davidson seats are made of leather. Fine leathers or other natural materials WILL gain "character," such as wrinkles or wear, with age. This is normal. A fine, aged patina and character wrinkles are a sign of the extremely high quality materials used to construct your seat or backrest. The appearance of scars or marks on the leather are a result of using natural leather panels and should not be thought of as an imperfection. Please use Harley-Davidson Leather Protectant P/N 93600034 to protect your investment.

Notice: The prices appearing in this catalog are the manufacturer's suggested retail prices. Actual retail prices may vary.



# DYNA® 149

Seating – Solo



C. BRAWLER SOLO SEAT

## C. BRAWLER® SOLO SEAT

When it's time to go it alone, go solo in style. These premium quality cowhide leather saddles are designed to create a subtle and distinctive look. Top-grain leather seating surfaces and contoured foam padding add long-haul comfort and the durable hand-laid fiberglass seat pan is carpeted to protect the paint finish. Does not fit with passenger pillions.

**51375-06**

**\$349.95**

Fits '06-later Dyna® models. Seat width 12.5".

## D. SIDEKICK® SEAT

Share your custom ride. The two-up design of these premium cowhide leather seats offers a frame-hugging look, but adds back support for the rider and additional padding for the passenger. Top-grain leather seating surfaces and contoured foam padding add long-haul comfort and the durable hand-laid fiberglass seat pan is carpeted to protect the paint finish.

**51353-06**

**\$399.95**

Fits '06-later Dyna models. FXD and FXDB models require separate purchase of Passenger Footpegs and Passenger Footpeg Mounting Kit P/N 50210-06. Seat width 12.5"; passenger pillion width 6.0".



D. SIDEKICK SEAT

*Notice: The prices appearing in this catalog are the manufacturer's suggested retail prices. Actual retail prices may vary.*

To add custom inlays and stitching to your Brawler® or Sidekick® seat, see pages 796-797, or visit: [www.h-d.com/customseat](http://www.h-d.com/customseat).



DYNA

# 150 DYNA®

Seating – Solo & Pillion

## A. SUNDOWNER™ SOLO SEAT

Ride solo on your Dyna® motorcycle in Sundowner™ comfort and style. This unique seat combines the deep bucket design and added back support of the two-up seat with the stripped-down look of a solo saddle. Matching passenger pillion is available for added versatility.

**51933-06** \$249.95

Fits '06-later Dyna® models. Seat width 14.5".

**51933-01** \$249.95

Fits '96-'03 Dyna models. Seat width 14.5".

### Shown with:

#### SUNDOWNER PASSENGER PILLION

Bring someone along for the ride without giving up your solo status. This carefully styled pillion matches Dyna Sundowner Solo Seat and provides your passenger with that great Sundowner comfort.

**51473-06A** \$159.95

Fits '06-later Dyna models equipped with Sundowner™ Solo Seat P/N 51933-06 or '06-'08 FXDB and '06-'09 FXDWG models equipped with Original Equipment solo seat. FXD and FXDB models require separate purchase of Passenger Footpegs and Passenger Footpeg Mounting Kit P/N 50210-06. Pillion width 12.0".



**A. SUNDOWNER SOLO SEAT  
(SHOWN WITH SUNDOWNER PASSENGER PILLION)**

## B. H-D® DETACHABLES™ PASSENGER PILLION

Styled to complement stock or accessory solo seats, this Passenger Pillion delivers maximum passenger comfort on the road. The pillion is easily removable from the Solo Rack P/N 52796-09 with a simple finger-pull release. The available Sissy Bar Upright P/N 52726-09 attaches directly to the pillion to provide a completely removable touring system.

**52689-09** \$219.95

Fits '06-later Dyna models (except FXDF, FXDFSE and '10-later FXDWG) with solo seats. Installation requires separate purchase of Rigid Solo Rack P/N 52796-09. FXD and FXDB models require separate purchase of Passenger Footpegs and Passenger Footpeg Mounting Kit P/N 50210-06. Pillion width 11.0".

## C. PASSENGER Sissy BAR UPRIGHT

Styled to blend with the muscular look of the Dyna family, this gloss black upright attaches directly to the passenger pillion for a clean look. Combine with Backrest Pad P/N 51782-07 for a complete touring system.

**52726-09** Gloss Black. \$59.95

Fits '06-later Dyna models (except FLD, FXDF, FXDFSE/2 and '10-later FXDWG) with solo seats. Installation requires separate purchase of Rigid Solo Rack P/N 52796-09 and Passenger Pillion P/N 52689-09.

### Shown with:

#### SMOOTH LOOK PASSENGER BACKREST PAD

This backrest sports a smooth, clean finish that looks great with any smooth surface seat.

**51782-07** \$79.95

Fits '07-'11 VRSC (except VRSCF), '06-'07 VRSCR and '06 VRSCSE2 models equipped with Sissy Bar Upright P/N 51162-06 or 51313-07, '06-later Dyna models equipped with Sissy Bar Upright P/N 52726-09.



**B. H-D DETACHABLES PASSENGER PILLION –  
REMOVED**



**C. PASSENGER Sissy BAR UPRIGHT  
(SHOWN WITH SMOOTH LOOK BACKREST PAD)**

## D. PASSENGER PILLION – SMOOTH STYLING

Bring a passenger along for the ride. This Passenger Pillion includes a passenger grab strap.

**51404-10** Smooth. \$144.95

Fits '09-later FXDB and '10-later FXDWG models with Original Equipment solo seat. Installation on FXDB models requires separate purchase of Passenger Footpegs and Passenger Footpeg Mounting Kit P/N 50210-06.

**51535-06A** Smooth. \$149.95

Fits '06-'09 Dyna models (except '09 FXDB). FXD and FXDB models require separate purchase of Passenger Footpegs and Passenger Footpeg Mounting Kit P/N 50210-06. Pillion width 9.5".

**51474-06A** Super Glide Texture. \$149.95

Fits '06-'09 Dyna models (except '09 FXDB). FXD and FXDB models require separate purchase of Passenger Footpegs and Passenger Footpeg Mounting Kit P/N 50210-06. Pillion width 9.5".



**D. PASSENGER PILLION – SMOOTH STYLING**



**D. PASSENGER PILLION –  
DYNA SUPER GLIDE TEXTURE**

*Notice: The prices appearing in this catalog are the manufacturer's suggested retail prices. Actual retail prices may vary.*





**E. LEATHER BADLANDER SEAT**

### E. LEATHER BADLANDER® SEAT

The traditional Badlander® Seat, with a low and lean style is enhanced with supple top-grain leather and an embroidered "H-D" logo. Kit includes leather care product, seat, grab strap and mounting hardware.

**52359-06 \$379.95**

Fits '06-later Dyna® models. FXD and FXDB models require separate purchase of Seat Bumper Kit P/N 51653-06, Passenger Footpegs and Passenger Footpeg Mounting Kit P/N 50210-06. Seat width 11.0"; passenger pillion width 5.0".

### F. BADLANDER SEAT

The popular Harley-Davidson® Badlander Seat is aggressively styled with a clean, smooth shape that flows from the fuel tank into the rear fender. Subtle top-stitching and the dual embroidered "Harley-Davidson" script logo add the finishing touches.

**52284-06 \$274.95**

Fits '06-later Dyna models. FXD and FXDB models require separate purchase of Seat Bumper Kit P/N 51653-06, Passenger Footpegs and Passenger Footpeg Mounting Kit P/N 50210-06. Seat width 11.0"; passenger pillion width 5.0".

**52284-04 \$274.95**

Fits '04-'05 Dyna models. Seat width 11.0"; passenger pillion width 5.0".

**52284-96A \$274.95**

Fits '96-'03 Dyna models. Seat width 11.0"; passenger pillion width 5.0".

### G. LOW-PROFILE LEATHER SEAT

Prowl the town in style. Featured as Original Equipment on the '07 CVO™ Dyna model, this low-profile seat features a breathable perforated leather insert. The firm padding makes you feel a part of the bike and the raised back stop keeps you in place when you hit the gas.

**52378-07 \$349.95**

Fits '06-later Dyna models. FXD and FXDB models require separate purchase of Passenger Footpegs and Passenger Footpeg Mounting Kit P/N 50210-06. Seat width 12.0"; passenger pillion width 7.0".



**F. BADLANDER SEAT**



**G. LOW-PROFILE LEATHER SEAT**

Note: Some Harley-Davidson seats are made of leather. Fine leathers or other natural materials WILL gain "character," such as wrinkles or wear, with age. This is normal. A fine, aged patina and character wrinkles are a sign of the extremely high quality materials used to construct your seat or backrest. The appearance of scars or marks on the leather are a result of using natural leather panels and should not be thought of as an imperfection. Please use Harley-Davidson Leather Protectant P/N 93600034 to protect your investment.

Notice: The prices appearing in this catalog are the manufacturer's suggested retail prices. Actual retail prices may vary.

## 152 DYNA®

Seating – Two-Up

### A. SUPER REDUCED REACH® SOLO SEAT

Get a little bit closer. Super Reduced Reach® forward position seats are designed to move riders with a shorter inseam even closer to the controls and to bring the legs about 1.0" closer together so that your feet rest firmly on the pavement. The scooped bucket-shaped saddle is enhanced with added back support padding to move the rider up to 1.0" lower and 3.0" forward. The combination positions the rider closer to the hand and foot controls to offer both comfort and confidence. For a two-up ride, combine the solo seat with the Touring Passenger Pillion P/N 51404-10 (sold separately).

**54384-11** **\$239.95**

Fits '06-later Dyna® models. Seat width 10.5".

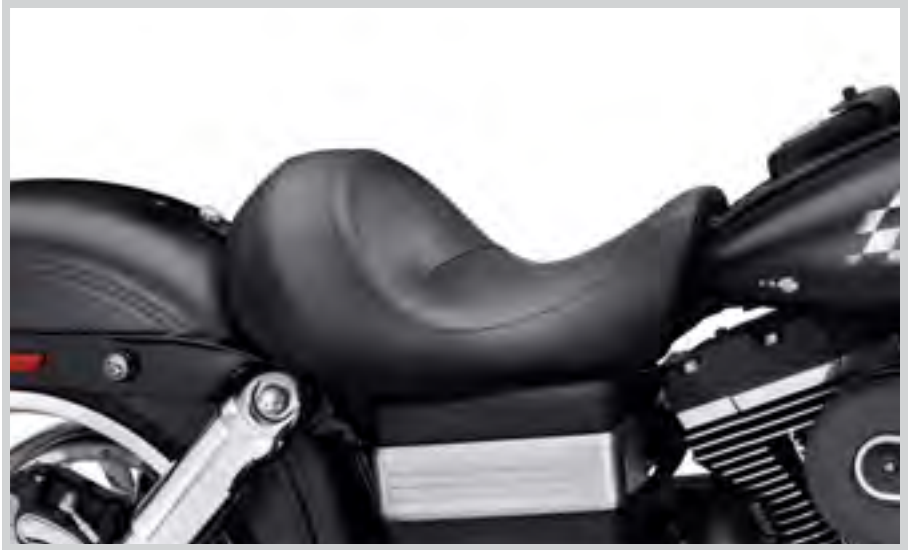

**A. SUPER REDUCED REACH SOLO SEAT**

### B. REDUCED REACH SEAT

Designed specifically for riders requiring a close to the bar riding position, this seat positions the rider approximately 1.0" forward, closer to the hand and foot controls. The narrow front profile brings your legs closer together to help you plant your feet firmly on the ground. The seat features a textured vinyl insert and a "Harley-Davidson" logo that shows you are riding in style.

**52288-06** **\$299.95**

Fits '06-later Dyna models. FXD and FXDB models require separate purchase of Seat Bumper Kit P/N 51653-06, Passenger Footpegs and Passenger Footpeg Mounting Kit P/N 50210-06. Seat width 12.0"; passenger pillion width 9.0".



**B. REDUCED REACH SEAT**

### C. RALLYRUNNER® SEAT

Share your custom ride. The two-up design of these premium cowhide leather seats offers a frame-hugging look, but adds back support for the rider and additional padding for the passenger. Top-grain leather seating surfaces and contoured foam padding add long-haul comfort and the durable hand-laid fiberglass seat pan is carpeted to protect the paint finish.

**51369-06** **\$399.95**

Fits '06-later Dyna models. FXD and FXDB models require separate purchase of Passenger Footpegs and Passenger Footpeg Mounting Kit P/N 50210-06. Seat width 12.5"; passenger pillion width 8.0".



**C. RALLYRUNNER SEAT**

Note: Some Harley-Davidson® seats are made of leather. Fine leathers or other natural materials WILL gain "character," such as wrinkles or wear, with age. This is normal. A fine, aged patina and character wrinkles are a sign of the extremely high quality materials used to construct your seat or backrest. The appearance of scars or marks on the leather are a result of using natural leather panels and should not be thought of as an imperfection. Please use Harley-Davidson Leather Protectant P/N 93600034 to protect your investment.

*Notice: The prices appearing in this catalog are the manufacturer's suggested retail prices. Actual retail prices may vary.*



# DYNA® 153

Seating – Two-Up



**D. SUNDOWNER SEAT  
(SHOWN WITH SMOOTH BUCKET PASSENGER BACKREST PAD)**



**E. SIGNATURE SERIES SEAT WITH RIDER BACKREST  
(SHOWN WITH SMOOTH LOW PASSENGER BACKREST PAD)**



**F. TALLBOY SEAT**

## D. SUNDOWNER™ SEAT

The Sundowner™ Seat provides the maximum in long-riding comfort. The deep-bucket design puts your body in the proper touring position and the generous padding makes it comfortable for both the rider and passenger as the miles are adding up. The dish shape provides added rider back support and the wide passenger pillion is shaped to minimize pressure points.

**51540-06** **\$339.95**

Fits '06-later Dyna® models. FXD and FXDB models require separate purchase of Seat Bumper Kit P/N 51653-06, Passenger Footpegs and Passenger Footpeg Mounting Kit P/N 50210-06. Seat width 16.0"; passenger pillion width 12.0".

**51540-04** **\$339.95**

Fits '04-'05 Dyna models. Seat width 16.0"; passenger pillion width 12.0".

**51540-01A** **\$339.95**

Fits '96-'03 Dyna models. FXDWG models require separate purchase of Bracket P/N 52152-97. Seat width 16.0"; passenger pillion width 12.0".

## E. SIGNATURE SERIES® SEAT WITH RIDER BACKREST

A perfect combination of foam density and shape has created our most comfortable seat for long-haul touring. Both rider and passenger will be extra comfy riding to Sturgis and back with the wide-seating area. When you reach your destination, city driving will be easier with the narrow nose that helps keep your legs closer together. Seat features an easily removable adjustable rider backrest that folds down for easier passenger mounting. Rider backrest has a 5-position height adjustment with 1.5" range and a wide range of forward/back angle adjustment with a quick twist of the control knob.

**52000015** **\$549.95**

Fits '06-later Dyna models. FXD and FXDB models require separate purchase of Seat Bumper Kit P/N 51653-06, Passenger Footpegs and Passenger Footpeg Mounting Kit P/N 50210-06. Seat width 16.0"; passenger pillion width 12.0".

## F. TALLBOY® SEAT

Stretch your legs in style. The Tallboy® one-piece seat moves the rider back 1.75" and up 2.0" as compared to the Original Equipment seat. The new position allows additional leg and arm movement for the long-limbed rider and a comfortable seating space for the open road. The Tallboy Seat also features a wide pillion for added passenger comfort.

**51471-06** **\$299.95**

Fits '06-later Dyna models. FXD and FXDB models require separate purchase of Seat Bumper Kit P/N 51653-06, Passenger Footpegs and Passenger Footpeg Mounting Kit P/N 50210-06. Seat width 16.0"; passenger pillion width 12.0".

Note: Some Harley-Davidson® seats are made of leather. Fine leathers or other natural materials WILL gain "character," such as wrinkles or wear, with age. This is normal. A fine, aged patina and character wrinkles are a sign of the extremely high quality materials used to construct your seat or backrest. The appearance of scars or marks on the leather are a result of using natural leather panels and should not be thought of as an imperfection. Please use Harley-Davidson Leather Protectant P/N 93600034 to protect your investment.

Notice: The prices appearing in this catalog are the manufacturer's suggested retail prices. Actual retail prices may vary.

## 154 DYNA®

Seating – Two-Up

### A. ROAD ZEPPELIN® AIR ADJUSTABLE SEAT

The mating of comfort and style. Low-profile Road Zeppelin® Seats are equipped with a unique adjustable air bladder system that distributes your weight across the seating surface. The air bladder system removes pressure points and provides shock absorption for the rider's and passenger's tailbone. You get hours of riding comfort without sacrificing the low-slung custom look. The combination of smooth vinyl and water-proof textured fabric seating surfaces allows air to circulate beneath the body, reducing the air temperature between the rider and seat. The easy-to-reach integrated hand pumps and air release valves permit quick and convenient adjustment for both the rider and passenger.

**52000147** **\$549.95**

Fits '06-later Dyna® models. Models not equipped with passenger pegs require separate purchase of Passenger Footpegs and Passenger Footpeg Mounting Kit P/N 50210-06. Seat width 13.0", passenger pillion width 10.5".



A. ROAD ZEPPELIN AIR ADJUSTABLE SEAT

### B. ROAD ZEPPELIN SEAT PAD

Experience ultimate comfort. Road Zeppelin Seat Pads are equipped with a unique air bladder system that allows your weight to be distributed evenly across the entire seating surface, ensuring hours of comfort for both rider and passenger. The air bladder system is designed to remove pressure points and provide shock absorption to reduce vibration. The mesh cover allows air to circulate beneath the rider's body, reducing the air temperature between the rider and seat. The easy-to-reach integrated hand pump and air release valve permits quick and convenient adjustment. Shaped to conform to most Harley-Davidson® seats, the pads feature an adjustable mounting strap and a non-skid surface to keep them in place.

**52000084** Rider. **\$129.95**

Fits rider position on all models equipped with Original Equipment or accessory seats. Also fits passenger position on Touring models with large pillion area. Pad width – 14.0".

**52400060** Passenger Pillion. **\$129.95**

Fits Original Equipment and accessory passenger pillions. Pad length – 11.0"; width – 8.0".



B. ROAD ZEPPELIN SEAT PAD

### C. CIRCULATOR SEAT PADS

Keep comfortable on your next long ride. These breathable Circulator Seat Pads feature 3D construction that promotes air movement and reduces heat build-up where the rider's body touches the seat and backrest. Designed to keep the rider cool by reducing the perspiration build-up between you and the seating surface, the Circulator Pad can be installed and removed in seconds for easy cleaning. The low-profile design minimizes seat-height change compared to inflatable pads, while enhancing comfort with its shock-absorbing construction. Manufactured of UV-stable materials, these seat pads resist fading when exposed to the sun. Elastic under-seat strap and non-slip base provide secure installation and the available Circulator Passenger Pillion Pad attaches to the rider pad with hook-and-loop tabs.

**51074-10** Medium Seat Pad. **\$79.95**

Fits VRSC™, XG, XL and Dyna models with Original Equipment and accessory seats. Pad width – 14.5"

**51078-10** Passenger Pillion Pad. **\$69.95**

Fits Original Equipment and accessory passenger pillions. Pad width – 13.0"



C. CIRCULATOR SEAT PADS

Notice: The prices appearing in this catalog are the manufacturer's suggested retail prices. Actual retail prices may vary.





**D. RAIN COVER – TWO-UP SEAT**

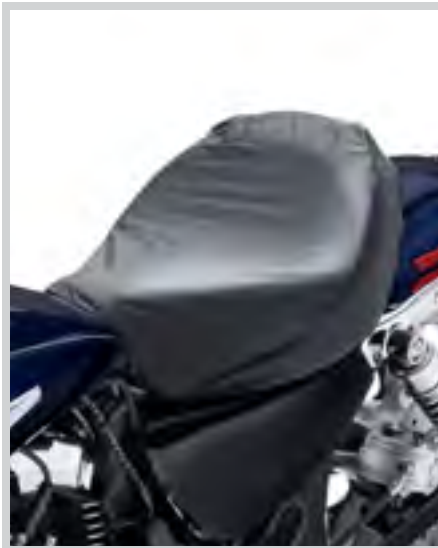

**D. RAIN COVER – SOLO SEAT**

### D. RAIN COVERS\*

Featuring a handy storage sack, this black nylon, water-resistant, Cordura® cover packs easily and shelters your seat from the storm.

**51637-97** Two-Up Seat. **\$31.95**  
Fits H-D® two-up seats (except XR, FLSTC and FLSTS seats with rider backrests).

**51638-97** Solo Seat. **\$29.95**  
Fits H-D solo seats (except XR and FLSTS).

**52952-97** Seat with Rider Backrest (not shown). **\$39.95**  
Fits most seats with rider backrest. Does not fit Trike models.

### E. BILLET SEAT MOUNTING BRACKET – CHROME

The highly stylized design of this bracket adds a stunning new look to the back of most seats.

**51804-02** **\$19.95**  
Replaces Bolt-On Seat Brackets P/N 51798-00, 51740-10, 52467-00, 51652-97A and 51652-83B used on most Original Equipment and accessory seats and pillions.

### F. QUICK-RELEASE SEAT HARDWARE KIT

This Hardware Kit allows the rider to remove one-piece Harley-Davidson® seats quickly and easily.

**51676-97A** **\$19.95**  
Fits '97-later XG, XL, Dyna®, Softail® (except FLS models equipped with Original Equipment seat) and Touring models. Does not fit seats equipped with spring-loaded rear seat bracket.

### G. REAR FENDER BIB

Go solo in style. Form-fitted to hug the contour of the rear fender, this decorative fender cover hides the seat mounting holes that are exposed when riding with a solo seat. Wrapped in smooth vinyl to match Original Equipment or accessory solo seats, the Fender Bib features an embossed Bar & Shield logo for added style. The molded base is finished with a soft felt under-liner designed to protect the fender's painted surface.

**52036-08** **\$59.95**  
Fits '06-later Dyna models equipped with Original Equipment solo seat, Brawler® Solo Seat or Sundowner™ Solo Seat.

### H. TANK BRA

This Tank Bra is made with nonabrasive, fleece-backed vinyl material and features an embroidered Bar & Shield logo. It protects your fuel tank from scratches from keys, belt buckles and other objects. Designed for easy installation and a custom fit without disassembly of the tank or seat.

**62028-04** **\$42.95**  
Fits '04-later Dyna models.

**57799-00** **\$43.95**  
Fits '93-'03 FXDWG and '00-later Softail models (except FXCW, FXCWC, FXS, FXSB, FXSTD, FXSTSE, FXSTSSE/2/3, '09-later FLS, FLSTC, FLSTFSE2, FLSTSB, FLSTSE/2/3).



**E. BILLET SEAT MOUNTING BRACKET – CHROME**



**F. QUICK-RELEASE SEAT HARDWARE KIT**



**G. REAR FENDER BIB**



**H. TANK BRA**



**\*WARNING:** Do not use while riding; could result in death or serious injury.

Notice: The prices appearing in this catalog are the manufacturer's suggested retail prices. Actual retail prices may vary.

# 156 DYNA®

Backrests & Racks

## Choosing a Backrest

A sissy bar upright and passenger backrest are the starting point to build a complete touring machine. The backrest provides long-range comfort and support and adds a feeling of control and confidence for the passenger. For permanent installation, choose rigid sideplates and a style of upright that suits your riding style. For added flexibility, choose a H-D® Detachables™ sideplate kit and appropriate Docking Hardware to make adding or removing a detachable accessory a simple "slide and click" proposition.



### H-D® Rigid Sideplates

Add practical comfort and support for your passenger. Rigid Sideplates supports are the anchor for sissy bar uprights, backrest pads and luggage racks, and hug the rear fender strut for a clean, streamlined look. Manufactured and tested to rigorous Harley-Davidson standards, these sideplates are designed to specific model application for exact fit.

1. Fits '06-later Dyna® models (except FLD, FXDWG, FXDF and FXDFSE/2).

**52856-06** Chrome. **\$94.95**

2. Fits '08-'13 FXDF and FXDFSE/2, '06-'08 FXDWG models.

**53020-06A** Chrome. **\$109.95**

3. Fits '96-'05 FXD and FXDL models (standard on '96-'00 FXDS-CONV.). Also fits '99 and '02-'05 FXDX and '01-'05 FXDXT models.

**52783-96B** Chrome. **\$104.95**

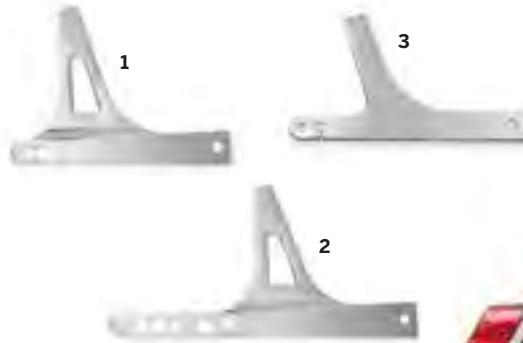

### H-D® Detachables™ Sideplates

4. Fits '06-later Dyna models (except FLD and '13-later FXDB HDI and India configuration). Requires separate purchase of appropriate Docking Hardware kit. '13-later FXDB models equipped with a side-mount license plate require License Plate Relocation Kit P/N 67900130. Not for use with LED Rear Turn Signal Kit P/N 67800055 or 67800056.

**52866-06** Chrome. **\$144.95**

**52124-09** Gloss Black. **\$144.95**

5. Fits '12-later FLD models. Requires separate purchase of Docking Hardware Kit P/N 52300065.

**52300070** Chrome. **\$144.95**

6. Fits '93-'05 FXDWG models. '93-'01 models using these sideplates in combination with Luggage Rack P/N 53711-96A, 53852-00 or 53866-00 require separate purchase of Adapter Kit P/N 53828-00. ('02-later models with Luggage Rack P/N 53899-02 do not require Adapter Kit.) (Not for use with Saddlebags.)

**53870-01A** Chrome. **\$144.95**

Fits '96-'05 Dyna models (except FXDWG and FXDXT). '96-'01 models using these sideplates in combination with Luggage Racks P/N 53711-96A, 53852-00 or 53866-00 require separate purchase of Luggage Rack Adapter Kit P/N 53828-00.

**53543-95A** Chrome. **\$144.95**



### H-D Adjustable Sideplates

Enhance your passenger's ride with an adjustable passenger backrest. When combined with your choice of Sissy Bar Upright and Backrest Pad, these Premium Adjustable Sideplates allow the passenger to change the recline angle of the passenger backrest for maximum comfort. Simply pull on the release levers and adjust the upright to one of three different recline settings. The exclusive cam lock detachable design lets you add or remove the passenger backrest assembly in seconds.

Fits '06-later Dyna models (except FLD and '13-later FXDB HDI and India configuration). Requires separate purchase of appropriate Docking Hardware kit. '13-later FXDB models equipped with a side-mount license plate require License Plate Relocation Kit P/N 67900130. Not for use with LED Rear Turn Signal Kit P/N 67800055 or 67800056.

**52300110** Chrome. **\$239.95**

**52300090** Gloss Black. **\$239.95**



*Notice: The prices appearing in this catalog are the manufacturer's suggested retail prices. Actual retail prices may vary.*



## Select a Height



Tall

### Tall Sissy Bar Upright

Let your passenger ride tall in the saddle with a Tall Sissy Bar Upright. This upright provides maximum upper back support when equipped with your choice of Backrest Pad.



Standard

### Standard Sissy Bar Upright

Give your passenger additional back support with a Standard Sissy Bar Upright, designed to accept a wide variety of Backrest Pads.



Low

### Low Sissy Bar Upright

Shaped to complement a thicker passenger pillion, this Low Sissy Bar Upright stands between the Standard and Short Sissy Bar Upright. The ideal match for touring style seats, this upright also offers an additional height option to riders with custom style seats.



Short

### Short Sissy Bar Upright

This Short Sissy Bar Upright is lower than traditional low uprights and the hidden Backrest Pad Mounting System allows for a sleek look when the pad is removed.

## Select a Style



Square Bar Medallion Style with 3-Bolt Pad Mount



Round Bar Mini Medallion Style with 3-Bolt Pad Mount



Round Bar Mini Medallion Style with 2-Bolt Pad Mount

Sissy Bar Uprights are available in a variety of shapes and styles. Square bar uprights feature a traditional plate design that provides a flat surface that is ideal for displaying self-adhesive medallions. Round bar uprights feature a mini medallion bar and an embossed Bar & Shield insert. Uprights are designed to accept specific 3-bolt or 2-bolt mounted backrest pads.

## Select Your Model

### Square Bar Upright

Height	Style	Finish	'91-'01 Dyna® models, '82-'00 FXR models		'02-'05 Dyna models		'06-later Dyna models (except FXDF, FXDFSE/2 and '10-later FXDWG)		'08-'09 FXDF and FXDFSE models	
			Part No.	Price	Part No.	Price	Part No.	Price	Part No.	Price
Short	Insert	Chrome	—	—	51513-02	\$74.95	52737-94A	\$74.95	—	—
Short	Insert	Gloss Black	—	—	—	—	52706-07	\$74.95	—	—
Low	Medallion	Chrome	52655-84	\$89.95	52909-02	\$89.95	52754-04	\$99.95	—	—
Low	Medallion	Gloss Black	—	—	—	—	51851-09	\$99.95	—	—
Standard	Medallion	Chrome	—	—	—	—	52735-85	\$89.95	52877-08	\$89.95
Tall	Medallion	Chrome	52777-85A	\$99.95	—	—	—	—	—	—

### Round Bar Upright

Height	Style	Finish	Fits '10-later FXDF, FXDFSE2 and FXDWG models		Fits '06-later Dyna models (except FXDF, FXDFSE/2 and '10-later FXDWG)					
			Part No.	Price	Part No.	Price	Part No.	Price	Part No.	Price
Low	Mini Medallion	Chrome	52300049	\$89.95	52300022	\$99.95	—	—	—	—
Low	Mini Medallion	Gloss Black	52300050	\$89.95	52300024	\$99.95	—	—	—	—
Standard	Mini Medallion	Chrome	52877-10	\$89.95	52300018	\$99.95	—	—	—	—
Standard	Mini Medallion	Gloss Black	51168-10	\$89.95	52300020	\$99.95	—	—	—	—

# 158 DYNA®

Backrests & Racks



Typical H-D® Detachables™ Docking Hardware Kit



## Select the Docking Hardware

### Dyna® Docking Hardware for H-D® Detachables™ Racks and Sideplates

Docking hardware fitment is dependent on vehicle model and saddlebag configuration.

#### H-D Detachables Accessory

**No Saddlebags:** Adjustable Sideplates 52300110 (Chrome), 52300090 (Gloss Black), Detachable Sideplates 52124-09 (Gloss Black), 53543-95A (Chrome), 53834-00A (Wrinkle Black), 52866-06 (Chrome), 53870-01A (Chrome), Detachable Solo Rack 53511-06, One-Piece Detachable Uprights 51161-10 (Gloss Black), 52300042 (Chrome), One-Piece Detachable Uprights 52300044 (Chrome), 52300046 (Gloss Black)

**With P&A Saddlebags:** Adjustable Sideplates 52300110 (Chrome), 52300090 (Gloss Black), Detachable Sideplates 52124-09 (Gloss Black), 53543-95A (Chrome), 53834-00A (Wrinkle Black), 52866-06 (Chrome), Detachable Solo Rack 53511-06, One-Piece Detachable Uprights 51161-10 (Gloss Black), 52300042 (Chrome), One-Piece Detachable Uprights 52300044 (Chrome), 52300046 (Gloss Black)

**With P&A Saddlebags:** 79300-06D, 88200-09A, 88348-10, 90181-08A, 90307-98, 90369-02, 90369-06D, 90564-02, 90564-06D, 91617-03, 91615-09A, 90126-YYXXX

**With Original Equipment Saddlebags:** Detachable Sideplates 52300070 (Chrome)

#### Available to fit:

		Required Docking Hardware		Directional Relocation Kit	
	1999 FXDX, 1996-2001 FXD & FXDL	53527-95B	\$49.95	—	—
	2002-2005 FXD, FXDC, FXDL & FXDX	53533-02B	\$49.95	—	—
	2001 FXDWG2, 2002 FXDWG3 & 2002-2005 FXDWG	53882-02B	\$59.95	—	—
	2006-2008 FXDWG & 2008-2009 FXDF and FXDFSE/2	53964-06B	\$29.95	—	—
	2006-later FXD, FXDC, FXDL and FXDSE/2, 2006-2008 FXDB	53961-06	\$49.95	53968-06C	\$49.95
	2009-later FXDB (except 2013-later HDI and India configuration)	53797-09	\$69.95	53968-06C	\$49.95
	2010-later FXDWG	54097-10	\$49.95	53968-06C	\$49.95
	2010-later FXDF	53964-06B	\$29.95	—	—
	1999 FXDX, 1996-2001 FXD & FXDL	53527-95B	\$49.95	—	—
	2002-2005 FXD, FXDC, FXDL & FXDX	53533-02B	\$49.95	—	—
	2006-2008 FXDWG & 2008-2009 FXDF and FXDFSE/2	53964-06B	\$29.95	—	—
	2006-later FXD, FXDC, FXDL and FXDSE/2, 2006-2008 FXDB	53961-06	\$49.95	—	—
	2009-later FXDB	53797-09	\$69.95	68227-09	\$109.95
	2010-later FXDWG	54097-10	\$49.95	53968-06C	\$49.95
	2010-later FXDF	53964-06B	\$44.95	—	—
	2012-later FLD	52300065	\$99.95	—	—

Notice: The prices appearing in this catalog are the manufacturer's suggested retail prices. Actual retail prices may vary.



# DYNA® 159

Backrests & Racks



**A. ONE-PIECE H-D DETACHABLES SISSY BAR UPRIGHT – CHROME**



## A. ONE-PIECE H-D® DETACHABLES™ SISSY BAR UPRIGHT

The sweeping shape of this slim, round bar Sissy Bar Upright completes the classic “bobber” look. The one-piece design eliminates separate sideplates for a clean appearance and the stylized upper kick angle mimics the old-school sissy bars of the '50s and '60s. Available in chrome and gloss black finishes, these bars can be equipped with Passenger Backrest Pad P/N 52631-07.

Fits '06-later Dyna® models (except FLD, FXDF, FXDFSE/2, '10-later FXDWG and '13-later FXDB HDI and India configuration). Requires separate purchase of appropriate Docking Hardware kit. '13-later FXDB models equipped with a side-mount license plate require License Plate Relocation Kit P/N 67900130. Not for use with LED Rear Turn Signal Kit P/N 67800055 or 67800056.

<b>52300044</b>	Chrome.	<b>\$199.95</b>
<b>52300046</b>	Gloss Black.	<b>\$199.95</b>

Fits '10-later FXDWG and FXDF models. Installation requires separate purchase of appropriate Docking Hardware Kit. Dyna Wide Glide® models require separate purchase of Docking Hardware Kit P/N 54097-10 and Turn Signal Relocation Kit P/N 53968-06C.

<b>52300042</b>	Chrome.	<b>\$199.95</b>
<b>51161-10</b>	Gloss Black.	<b>\$199.95</b>



**A. ONE-PIECE H-D DETACHABLES SISSY BAR UPRIGHT – GLOSS BLACK**



## B. LOCKING H-D DETACHABLES LATCH KIT

This unique lock replaces the camlock on your Harley-Davidson® Detachables™ accessories, providing additional security and peace of mind when parking your vehicle. The kit includes two extended-reach barrel-style keys for easy access to the lock. Key registration and replacement service is available. Sold in pairs.

Fits all models equipped with detachable Sideplates, Racks and Tour-Pak® Luggage Carriers (except '09-later Touring models equipped with detachable Solo Tour-Pak Rack).

<b>90300087</b>	Chrome.	<b>\$79.95</b>
<b>90300086</b>	Black.	<b>\$69.95</b>

## C. H-D DETACHABLES LATCH KIT – CHROME

Decorative chrome latches are the perfect way to enhance the appearance of your detachable accessories. Meticulously polished and chrome-plated, these easy-to-install Rotary Latches are a direct replacement for the Original Equipment satin black parts and are a simple way to add a finishing touch to your ride. Latches feature an easy-to-pull finger release to simplify access in hard-to-reach areas.

<b>12600036</b>		<b>\$49.95</b>
-----------------	--	----------------

Fits all models equipped with detachable Sideplates, One-Piece Sissy Bar Uprights, Racks and Tour-Pak Luggage Mounting Racks.



**B. LOCKING H-D DETACHABLES LATCH KIT – CHROME**



**B. LOCKING H-D DETACHABLES LATCH KIT – BLACK**



**C. H-D DETACHABLES LATCH KIT – CHROME**

*Notice: The prices appearing in this catalog are the manufacturer's suggested retail prices. Actual retail prices may vary.*

DYNA

# 160 DYNA®

## Backrests & Racks

### PASSENGER BACKREST PADS

Choose from a wide variety of backrest pad sizes and shapes to match your comfort and style demands. Designed to complement Original Equipment and accessory seats, these pads are engineered to fit specific sissy bar upright types.

#### A. SLIP-OVER PASSENGER BACKREST PAD

This Slip-Over Backrest Pad provides a touch of passenger comfort, while maintaining the long, lean style of the Dyna® Wide Glide® model. Held in place with hook-and-loop tabs, this rich black pad features grey stitching that complements the Original Equipment seat and pillion.

**51732-10** **\$69.95**  
Fits '10-later FXDWG models with Original Equipment sissy bar upright.



A. SLIP-OVER PASSENGER BACKREST PAD

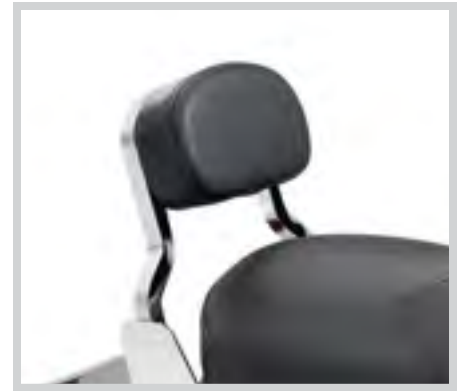

B. SHORT BACKREST PAD

#### B. SHORT BACKREST PAD

Innovative Backrest Pad Mounting System features a brushed stainless steel insert framed with chrome plate and hardware.

**52517-94** **\$59.95**  
Fits Short Insert Style Sissy Bar Upright P/N 51513-02, 52737-94A or 52706-07.

#### C. BACKREST PADS

Sized to fit medallion and mini medallion-style sissy bar uprights. Pad mounts with single center screw and bolt-on mounting strap. Includes chrome-plated mounting hardware.

Fits Low Medallion Style Sissy Bar Upright P/N 52754-04 or 51851-09, Low Square Bar Mini-Medallion Style Sissy Bar Upright P/N 53282-06, Standard Square Bar Mini Medallion Style Sissy Bar Upright P/N 53281-06 or 53407-06, Standard Medallion Style Sissy Bar Upright P/N 52735-85, 53007-98, 52655-84, 52909-02 or 51517-02, Standard Bar & Shield Style Sissy Bar Upright 52739-83 or 51514-02, Standard Heritage Style Sissy Bar Upright P/N 52731-00 and Low Round Bar Sissy Bar Upright P/N 52300022 or 52300024.

**1. 52652-04** Smooth. **\$69.95**  
**2. 52626-04** Smooth Top-Stitched. **\$69.95**



C. BACKREST PADS

#### D. BACKREST PADS

Sized to fit round bar sissy bar uprights, these pads mount to mini medallion style uprights with two mounting holes.

Fits Standard Round Bar Mini-Medallion Style Upright P/N 52877-10 or 51168-10. Also fits Low Round Bar Mini Medallion Style Sissy Bar Upright P/N 52540-09A, 51477-06, 54256-10, 52300049 and 52300050.

**1. 51641-06** Smooth Top-Stitched. **\$69.95**  
**2. 51640-06** Smooth Bucket. **\$99.95**  
**3. 51622-07** Fat Boy® Lacing Bucket. **\$119.95**  
**4. 52300301** CVO™ FXSBSE Style – Black. **\$129.95**  
**5. 52300293** CVO FXSBSE Style – Brown. **\$129.95**  
**6. 52300336** '14 CVO FXSBSE Style. **\$129.95**

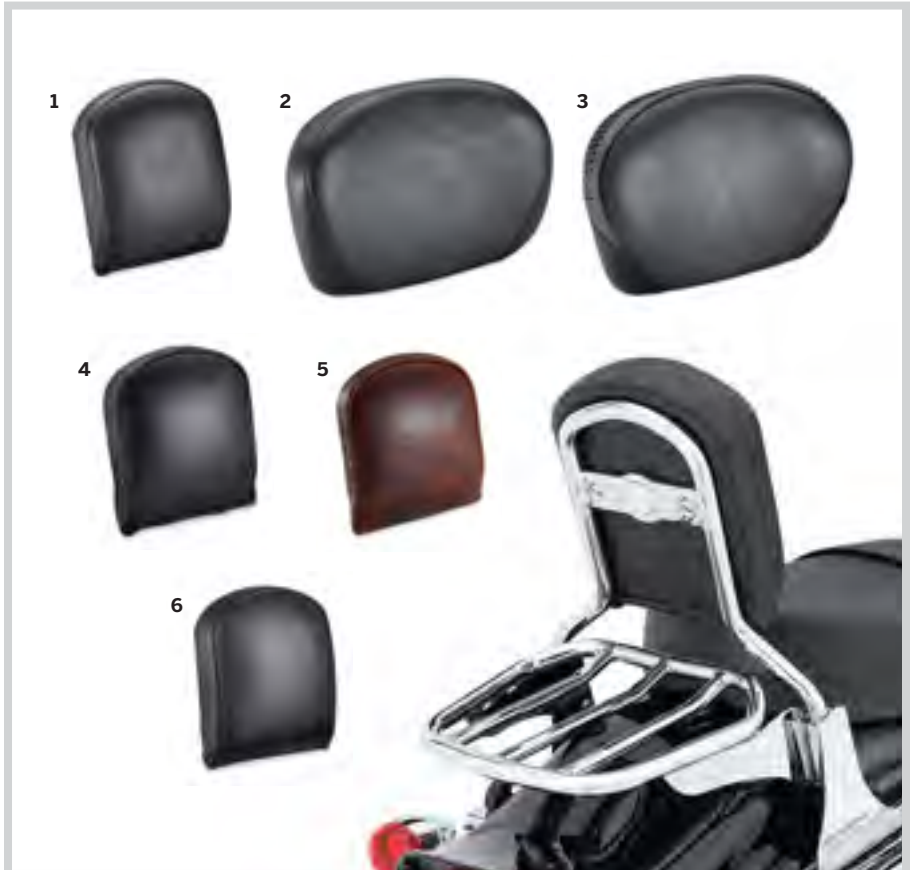

D. BACKREST PADS

*Notice: The prices appearing in this catalog are the manufacturer's suggested retail prices. Actual retail prices may vary.*





**E. BACKREST PADS**

**E. BACKREST PADS**

Sized to fit medallion and mini medallion-style sissy bar uprights. Pad mounts with single center screw and bolt-on mounting strap. Kit includes chrome-plated mounting hardware.

Fits Low Medallion Style Sissy Bar Upright P/N 52655-84, 52909-02, 52754-04, 51851-09, Standard Medallion Style Sissy Bar Upright P/N 52735-85 or 52877-08, Standard Square Bar Mini Medallion Style Sissy Bar Upright P/N 53281-06 or 53407-06, Standard Heritage Style Sissy Bar Upright P/N 52731-00 and Standard Round Bar Sissy Bar Upright P/N 52300018 or 52300020.

<b>1. 52612-95</b>	Smooth Top-Stitched.	<b>\$69.95</b>
<b>2. 52412-79A</b>	Embossed Bar & Shield Logo.	<b>\$69.95</b>
<b>3. 52532-90</b>	Fat Boy®.	<b>\$79.95</b>
<b>4. 52348-97</b>	Heritage Classic Bucket.	<b>\$109.95</b>
<b>5. 52347-97</b>	Fat Boy Bucket.	<b>\$99.95</b>
<b>6. 51132-98</b>	Smooth Bucket.	<b>\$99.95</b>

**F. BACKREST PADS**

Sized to fit tall medallion and insert-style sissy bar uprights. Pads mount with upper bolt-on mounting strap and two lower mounting clips. Kit includes chrome-plated mounting brackets and hardware.

Fits Tall Medallion Style Sissy Bar Upright P/N 52777-85A, 51519-02 or 52749-85A. Also fits Tall Insert Style Sissy Bar Upright P/N 51518-02 or 53552-81A.

<b>52965-98</b>	Smooth Top-Stitched.	<b>\$79.95</b>
-----------------	----------------------	----------------

**G. PASSENGER BACKREST PAD**

Styled to complement available touring and custom seats.

<b>52631-07</b>		<b>\$69.95</b>
-----------------	--	----------------

Fits One-Piece H-D® Detachables™ Sissy Bar Upright P/N 52729-08, 51853-07, 51849-07, 51146-10, 51161-10, 52300040, 52300042, 52300044 or 52300046.

**H. CIRCULATOR BACKREST PAD**

Keep comfortable on your next long ride. These breathable Circulator Backrest Pads feature 3D construction that promotes air movement and reduces heat build-up where the rider's body touches the backrest. Designed to keep the rider cool by reducing the perspiration build-up between you and the backrest surface, the Circulator Pad can be installed and removed in seconds for easy cleaning. Manufactured of UV-stable materials, these pads resist fading when exposed to the sun.

<b>52300103</b>	Wide Backrest Pad.	<b>\$59.95</b>
-----------------	--------------------	----------------

Fits wide profile rider and passenger backrest pads up to 12.0" wide and 9.0" tall.



**F. BACKREST PADS**



**G. PASSENGER BACKREST PAD**



**H. CIRCULATOR BACKREST PAD**

*Notice: The prices appearing in this catalog are the manufacturer's suggested retail prices. Actual retail prices may vary.*



# 162 DYNA®

## Backrests & Racks

### A. CUSTOM TAPERED SPORT LUGGAGE RACK\*

Smooth sweeping curves and the brilliant chrome or gloss black finish define the look of this Sport Luggage Rack. Designed to complement both round and square bar Sissy Bar Uprights, this sleek rack adds a practical and stylish touch to the motorcycle.

Fits '04-later XL models equipped with H-D® Detachables™ Sideplates, '06-later Dyna® models (except FXDF, FXDFSE/2 and '10-later FXDWG) equipped with Rigid or Detachable Sideplates, '84-'05 Softail® models (except FXSTD and FLSTN) and '06-later FLST, FLSTC, FLSTNSE and FLSTSC models and '06 FLSTF models equipped with Detachable or Rigid Mount Sideplates.

<b>50300030</b>	Chrome.	<b>\$139.95</b>
<b>50300031</b>	Gloss Black.	<b>\$139.95</b>

Fits '10-later FXDF, FXDFSE2 and FXDWG models equipped with Rigid or H-D Detachables Sideplates and Sissy Bar Uprights.

<b>54049-10</b>	Gloss Black.	<b>\$134.95</b>
<b>54055-10</b>	Chrome.	<b>\$134.95</b>



A. CUSTOM TAPERED SPORT LUGGAGE RACK – CHROME



A. CUSTOM TAPERED SPORT LUGGAGE RACK – GLOSS BLACK

### B. AIR FOIL PREMIUM LUGGAGE RACK\*

The low-profile aerodynamic styling defines the look of this Luggage Rack. Available in mirror-chrome or rich gloss black finish, the die-cast rear "Air Foil" grabs your attention and the Bar & Shield insert adds a signature touch. The elegant round tube rack features inlaid rubber runners for added grip and dedicated bungee mounting points to simplify luggage tie-down. Kit includes all necessary mounting hardware. For added visibility, the rack is designed to incorporate the internal wiring of the Air Foil Rack LED Light Kit P/N 68000076 (red) or 68000077 (smoked) for a clean look.

Fits '04-later XL models equipped with H-D Detachables Sideplates, '06-later Dyna models (except FXDF, FXDFSE/2 and '10-later FXDWG) equipped with Rigid or Detachable Sideplates, '84-'05 Softail models (except FXSTD and FLSTN) and '06-later FLST, FLSTC, FLSTNSE and FLSTSC models and '06 FLSTF models equipped with Detachable or Rigid Mount Sideplates.

<b>54290-11</b>	Chrome.	<b>\$209.95</b>
<b>54291-11</b>	Gloss Black.	<b>\$209.95</b>



B. AIR FOIL PREMIUM LUGGAGE RACK – CHROME

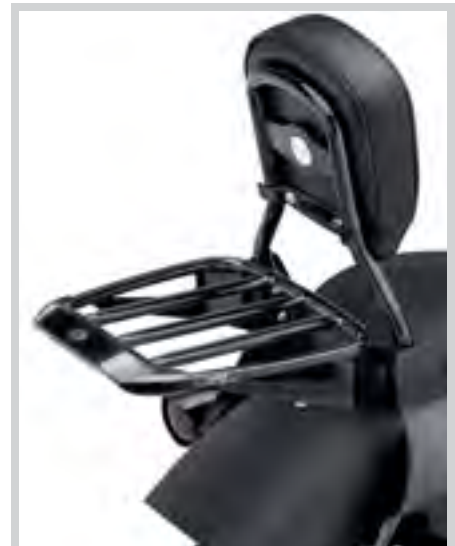

B. AIR FOIL PREMIUM LUGGAGE RACK – GLOSS BLACK

### C. LED LIGHT KIT

Custom fit to the Air Foil Luggage Rack, this fast-acting LED Light Kit operates as a supplemental rear running light and brake light. The high, center-mount position places the light in the line-of-sight of following vehicles and the bright, fast-acting LED lamps get you noticed. Wiring is concealed inside the rack tubes for a clean, custom installation. Available with red or smoked lens.

Fits Air Foil Luggage Rack P/N 54290-11, 54291-11 and Air Wing Sissy Bar Upright P/N 52300146 and 52300147. Installation requires separate purchase of model-specific Wiring Harness Kit.

<b>68000076</b>	Red Lens.	<b>\$44.95</b>
<b>68000077</b>	Smoked Lens.	<b>\$44.95</b>

#### Also available:

#### LED LIGHT KIT WIRING HARNESS

Required for installation of LED Light Kit on Air Foil Luggage Rack P/N 54290-11 or 54291-11.

<b>73415-11</b>		<b>\$11.95</b>
Fits '06-later Dyna models (except FXDF, FXDFSE/2, '14-later FXDL and '10-later FXDWG), '84-'05 Softail models (except FXSTD and FLSTN), '06-later FLST, FLSTC and FLSTSC models and '06 FLSTF models with Air Foil Luggage LED Light Kit P/N 68000076 or 68000077.		



C. LED LIGHT KIT – RED LENS



**\*WARNING:** Do not use this rack as a seat. Do not exceed the fender rack weight capacity. Using as seat or exceeding this capacity could cause handling problems which could result in loss of control and death or serious injury.

Notice: The prices appearing in this catalog are the manufacturer's suggested retail prices. Actual retail prices may vary.



# DYNA® 163

## Backrests & Racks



**D. TAPERED LUGGAGE RACK – CHROME**



**D. TAPERED LUGGAGE RACK – GLOSS BLACK**

### D. TAPERED LUGGAGE RACK\*

Styled to enhance the lines of the motorcycle, this sleek, compact Tapered Rack is an elegant solution for carrying your lunch to work or your luggage across the country.

Fits '04-later XL models equipped with H-D® Detachables™ Sideplates, '06-later Dyna® models (except FXDF, FXDFSE/2 and '10-later FXDWG) equipped with Rigid or Detachable Sideplates, '84-'05 Softail® models (except FXSTD and FLSTN) and '06-later FLST, FLSTC, FLSTNSE and FLSTSC models and '06 FLSTF models equipped with Detachable or Rigid Mount Sideplates.

<b>53718-04</b>	Chrome.	<b>\$119.95</b>
<b>53510-07</b>	Gloss Black.	<b>\$119.95</b>

### E. SPORT LUGGAGE RACK – FOUR BAR\*

This sleek rack complements the lines of your motorcycle. Can be used with H-D® Detachables™ or Rigid Mount Sissy Bar Sideplates.

**53899-02** Chrome. **\$119.95**

Fits '04-later XL models equipped with Rigid Sideplates P/N 53925-04 and '02-'05 Dyna models equipped with Rigid Sideplates or Detachable Sideplates.

**53711-96A** Chrome. **\$119.95**

Fits '90-'03 XL models with H-D Detachables Sideplate Kit P/N 53545-95, '82-'03 XL models with Rigid Mount Sideplate Kit P/N 52806-94B or 52782-82B; '82-'94 FXR models with Rigid Sideplate Kit P/N 52781-82B (except FXRS-CONV. and FXRT). Fits '96-'01 Dyna models (except FXDWG). All '96-'01 Dyna models equipped with Rigid Mount Sideplates require the separate purchase of Luggage Rack Adapter Kit P/N 53828-00. Also fits '99-'00 FXR models.



**E. SPORT LUGGAGE RACK – FOUR BAR**



**F. SPORT LUGGAGE RACK – FIVE BAR**

### F. SPORT LUGGAGE RACK – FIVE BAR\*

This rack brings touring flexibility to your motorcycle. Can be used with H-D Detachables or Rigid Mount Sissy Bar Sideplates.

**53862-00** Chrome. **\$139.95**

Fits '04-later XL models equipped with Detachable Sideplates, '06-later Dyna models (except FXDF, FXDFSE/2 and '10-later FXDWG) equipped with Rigid or Detachable Sideplates, '84-'05 Softail models (except FXSTD and FLSTN), '06-later FLST, FLSTC and FLSTSC models and '06 FLSTF models equipped with Rigid or Detachable Sideplates. Does not fit with Round Bar Uprights P/N 52300018, 52300020, 52300022 and 52300024.

### G. CHOPPED FENDER LUGGAGE RACK\*

This Luggage Rack is the ideal option for your ride across town or across the state. Designed for the chopped rear fender, this simple rack adds practical luggage space without compromising style. Rear supports attach to the fender struts and the rack is secured to the passenger pillion mounting point on the rear fender. Available in your choice of chrome or gloss black finish, this rack is compatible with the Original Equipment short upright or H-D Detachables uprights and docking hardware.

Fits '10-later FXDWG models.

<b>54252-10</b>	Gloss Black.	<b>\$144.95</b>
<b>50300038</b>	Chrome.	<b>\$144.95</b>



**G. CHOPPED FENDER LUGGAGE RACK – CHROME**



**G. CHOPPED FENDER LUGGAGE RACK – GLOSS BLACK**



**\*WARNING:** Do not use this rack as a seat. Do not exceed the fender rack weight capacity. Using as seat or exceeding this capacity could cause handling problems which could result in loss of control and death or serious injury.

Notice: The prices appearing in this catalog are the manufacturer's suggested retail prices. Actual retail prices may vary.

# 164 DYNA®

## Backrests & Racks

### A. BOBTAIL FENDER RACK\*

Style and function come together in this beautifully sculpted luggage rack. The sweeping rails and the narrow cross tubing combine to form a rack that follows the contour and enhances the shape of the bobtail fender. And because the rack floats above the fender, you have a convenient spot to secure a duffle bag or touring luggage without risking damage to the painted surface.

Fits '08-'13 FXDF and '06-'08 FXDWG models. Does not fit FXDFSE/2. Does not fit with Tri-Bar LED Tail Light Kit P/N 68546-09.

<b>56802-06A</b>	Chrome.	<b>\$99.95</b>
<b>50300036</b>	Gloss Black.	<b>\$99.95</b>



A. BOBTAIL FENDER RACK – CHROME



A. BOBTAIL FENDER RACK – GLOSS BLACK

### B. H-D® DETACHABLES™ SOLO RACK\*

Add touring capabilities to your solo seat Dyna® model in less than 60 seconds. This detachable Solo Rack fits over the fender when the passenger pillion is removed. The rack features a hand-polished and chrome-plated finish to add a stylish flair. Requires Docking Hardware.

**53511-06** Chrome. **\$199.95**  
Fits '06-later Dyna models (except FLD, FXDF, FXDFSE/2 '10-later FXDWG or '13-later FXDB HDI and India configuration) equipped with solo seat. Requires separate purchase of appropriate Detachable Docking Hardware. '13-later FXDB models equipped with a side-mount license plate require License Plate Relocation Kit P/N 67900130.



B. H-D DETACHABLES SOLO RACK



C. RIGID SOLO RACK

### C. RIGID SOLO RACK\*

Versatile rigid-mount Solo Luggage Rack features a rich gloss black finish that complements almost any paint color. Equip the contoured rack with a duffle bag for a cross-country solo ride or attach the available H-D® Detachables™ Passenger Pillion P/N 52689-09 for a comfortable two-up tour.

**52796-09** Gloss Black. **\$159.95**  
Fits '06-later Dyna models with solo seats (except FLD, FXDF, FXDL, FXDFSE/2 and '10-later FXDWG).

### D. REAR DOCKING HARDWARE COVER KIT

Disguise the rear docking hardware with these easy-to-install covers. The caps slide over the exposed docking points and are held in place by a strong magnetic pull. The caps are easy to remove when you wish to reinstall detachable accessories. Covers are available with brilliant chrome or durable gloss black finish to match your bike's attitude. Sold in pairs.

Fits many accessory docking hardware kits. Refer to the fitment matrix in this P&A Catalog page 573 or the Parts & Accessories section of [www.harley-davidson.com](http://www.harley-davidson.com) for details.

<b>48218-10</b>	Short Chrome (pair).	<b>\$34.95</b>
<b>48220-10</b>	Large Chrome (pair).	<b>\$34.95</b>
<b>48035-09</b>	Small Chrome (pair).	<b>\$34.95</b>
<b>48221-10</b>	Short Black (pair).	<b>\$34.95</b>
<b>48223-10</b>	Large Black (pair).	<b>\$34.95</b>
<b>48225-10</b>	Small Black (pair).	<b>\$34.95</b>



D. REAR DOCKING HARDWARE COVER KIT – CHROME



D. REAR DOCKING HARDWARE COVER KIT – GLOSS BLACK



**\*WARNING:** Do not use this rack as a seat. Do not exceed the fender rack weight capacity. Using as seat or exceeding this capacity could cause handling problems which could result in loss of control and death or serious injury.

Notice: The prices appearing in this catalog are the manufacturer's suggested retail prices. Actual retail prices may vary.



# DYNA® 165

## Saddlebags & Luggage

### E. H-D® DETACHABLES™ LEATHER SADDLEBAGS FOR DYNA® MODELS

These large capacity detachable saddlebags are completely removable with the simple pull of the internal handle, leaving your bike clean and ready to cruise the boulevard. The handsome leather bags feature hidden quick-release clips behind the traditional strap and buckle. When removed, the large capacity bags leave behind two simple, inconspicuous docking points. The bags are compatible with both rigid and H-D® Detachables™ accessories when installed with the appropriate docking hardware kits. Luggage capacity: 2400 cubic inches total.

**90181-08A** **\$949.95**  
 Fits '06-later Dyna® models (except FLD). '09-later FXDB models require separate purchase of Turn Signal Relocation Kit P/N 68227-09. '10-later FXDWG models require separate purchase of Turn Signal Relocation Kit P/N 68544-10. All other models (except FXDF and '06-'08 FXDWG) require separate purchase of Turn Signal Relocation Kit P/N 68732-02A (Domestic), P/N 68733-02A (International) or Layback License Plate Kit P/N 60215-06. Does not fit with Rear Axle Covers or Premium Profile Low Suspension Kit P/N 54619-08.

**Also available:**

**TURN SIGNAL RELOCATION KIT**

Required for installation of rigid mounted saddlebags and detachable accessories on '09-later FXDB models.

**68227-09** Fits '09-later FXDB models. **\$109.95**

**TURN SIGNAL RELOCATION KIT**

Kit moves turn signals from rear fender struts to a license bracket-mounted turn signal bar.

Required to install Saddlebags P/N 91615-09A, 88200-09A, 90181-08A, 90460-06B, 79300-06A, 90564-06B, 90369-06C and 88343-10. Fits '02-later Dyna models (except FXDWG, FXDF and '09-later FXDB) and '04-later XL models (except XL883N, XL1200N, XL1200X and '11-later XL1200C). Does not fit with Layback License Plate Mounting Kits.

**68732-02A** Domestic. **\$89.95**

**68733-02A** International. **\$89.95**

**TURN SIGNAL RELOCATION KIT**

Kit moves turn signals from rear fender struts to a license bracket-mounted turn signal bar.

Required to install Saddlebags P/N 79078-02, 79300-04B and 91622-03.

**68718-02** Fits '02-'05 FXDWG models. **\$39.95**

**DYNA LICENSE PLATE/TURN SIGNAL RELOCATION KIT**

Required for installation of Saddlebags.

**68544-10** **\$249.95**

Fits '10-later FXDWG models equipped with saddlebags.

**LICENSE PLATE RELOCATION KIT**

Required for installation of available saddlebags and/or detachable sissy bars on '13-later FXDB models equipped with side-mount license plate. Kit replaces Original Equipment side-mount license plate.

**67900130** **\$134.95**

Fits '13-later FXDB models equipped with side-mount license plate.



**E. H-D DETACHABLES LEATHER SADDLEBAGS FOR DYNA MODELS**



**STEP 1**

Equipped with large capacity saddlebags, your bike is ready to take on the longest journey.



**STEP 2**

Pull and turn the hidden cam lock to release the bags from the docking hardware.



**STEP 3**

Slide the bag rearward to disengage the mounting bracket and lift the bags away.



**STEP 4**

You are left with a stripped-down cruiser, ready to prowl the streets.

NOTE: Some Harley-Davidson® saddlebags are made of leather. Fine leathers or other natural materials WILL gain "character," such as wrinkles or wear, with age. This is normal. A fine, aged patina and character wrinkles are a sign of the extremely high quality materials used to construct your saddlebags. The appearance of scars or marks on the leather are a result of using natural leather panels and should not be thought of as an imperfection. Please use Harley-Davidson Leather Protectant P/N 93600034 to protect your investment.

Notice: The prices appearing in this catalog are the manufacturer's suggested retail prices. Actual retail prices may vary.

DYNA

# 166 DYNA®

## Saddlebags & Luggage

### A. RIGID LOCKING LEATHER SADDLEBAGS

These saddlebags combine a premium leather finish with extra-durable construction. The hard-shell design is covered in leather for a traditional look, while the locking hinged lids offer modern convenience and security. Styled to complement the sleek, narrow Dyna® profile, these bags offer plenty of storage for a trip across town or across the country. Kit includes reflectors. Luggage capacity: 2400 cubic inches total.

**91615-09A** **\$729.95**

Fits '02-later Dyna models (except FLD, '02-'05 FXDWG and '09-later FXDBP with optional chrome or black strut covers). '02-'05 models require separate purchase of Mounting Hardware Kit P/N 92025-09. '10-later FXDWG models require separate purchase of Turn Signal Relocation Kit P/N 68544-10. '09-later FXDB models require separate purchase of Turn Signal Relocation Kit P/N 68227-09. '13-later FXDB models equipped with side-mount license plate requires License Plate Relocation Kit P/N 67900130. All other years and models (except FXDF and FXDWG) require separate purchase of Turn Signal Relocation Kit P/N 68732-02A (Domestic), 68733-02A (International) or Layback License Plate Kit P/N 60215-06. Not for use with Rear Axle Covers on FXDF and FXDWG models.



A. RIGID LOCKING LEATHER SADDLEBAGS

### B. BROWN DISTRESSED LEATHER SADDLEBAGS

A vintage look for a modern ride. These large capacity saddlebags are dressed in brown distressed leather for a timeless appearance. The raw edging and untreated leather surfaces will age and weather for a warm, comfortable feel, but the rigid-back construction will help the bag hold its shape. Dark metal snaps and an embossed Bar & Shield logo continue the bomber jacket look. Luggage capacity: 2380 cubic inches total.

**88348-10** **\$629.95**

Fits '02-later Dyna models (except FLD, '02-'05 FXDWG and '09-later FXDBP with optional chrome or black strut covers). '02-'05 models require separate purchase of Mounting Hardware Kit P/N 92025-09. '09-later FXDB models require separate purchase of Turn Signal Relocation Kit P/N 68227-09. '10-later FXDWG models require separate purchase of Turn Signal Relocation Kit P/N 68544-10. '13-later FXDB models equipped with side-mount license plate requires License Plate Relocation Kit P/N 67900130. All other years and models (except FXDF and FXDWG) require separate purchase of Turn Signal Relocation Kit P/N 68732-02A (Domestic), 68733-02A (International) or Layback License Plate Kit P/N 60215-06. Not for use with Rear Axle Covers on FXDF and FXDWG models.



B. BROWN DISTRESSED LEATHER SADDLEBAGS

### C. BLACK DISTRESSED LEATHER SADDLEBAGS

Step over to the dark side. Distressed black leather with hints of coffee brown and aged buckles provide a weathered, "anti-chrome" look to your blacked-out ride. The riveted Dark Custom™ logo patch on the rear of each bag completes the edgy, tradition-breaking appearance. Luggage capacity: 2380 cubic inches total.

**88200-09A** **\$629.95**

Fits '02-later Dyna models (except FLD, '02-'05 FXDWG and '09-later FXDBP with optional chrome or black strut covers). '02-'05 models require separate purchase of Mounting Hardware Kit P/N 92025-09. '09-later FXDB models require separate purchase of Turn Signal Relocation Kit P/N 68227-09. '10-later FXDWG models require separate purchase of Turn Signal Relocation Kit P/N 68544-10. '13-later FXDB models equipped with side-mount license plate requires License Plate Relocation Kit P/N 67900130. All other years and models (except FXDF and FXDWG) require separate purchase of Turn Signal Relocation Kit P/N 68732-02A (Domestic), 68733-02A (International) or Layback License Plate Kit P/N 60215-06. Not for use with Rear Axle Covers on FXDF and FXDWG models.



C. BLACK DISTRESSED LEATHER SADDLEBAGS

NOTE: Some Harley-Davidson® saddlebags are made of leather. Fine leathers or other natural materials WILL gain "character," such as wrinkles or wear, with age. This is normal. A fine, aged patina and character wrinkles are a sign of the extremely high quality materials used to construct your saddlebags. The appearance of scars or marks on the leather are a result of using natural leather panels and should not be thought of as an imperfection. Please use Harley-Davidson Leather Protectant P/N 93600034 to protect your investment.

Notice: The prices appearing in this catalog are the manufacturer's suggested retail prices. Actual retail prices may vary.





D. LEATHER SADDLEBAGS FOR DYNA MODELS



E. LEATHER SADDLEBAGS FOR DYNA MODELS



F. SYNTHETIC LEATHER SADDLEBAGS

**D. LEATHER SADDLEBAGS FOR DYNA® MODELS**

These genuine leather saddlebags deliver style and large capacity all in one. Constructed around a rigid plastic tub for long term durability, the leather bag features a stylish design with lines that enhance the smooth Dyna® model profile. The leather saddlebags provide custom looks and tons of storage space for the road. Hidden quick-release closures add packing convenience. Luggage capacity: 2380 cubic inches total.

**90369-06D \$629.95**

Fits '02-later Dyna models (except FLD, '02-'05 FXDWG and '09-later FXDBP with optional chrome or black strut covers). '02-'05 models require separate purchase of Mounting Hardware Kit P/N 92025-09. '09-later FXDB models require separate purchase of Turn Signal Relocation Kit P/N 68227-09. '10-later FXDWG models require separate purchase of Turn Signal Relocation Kit P/N 68544-10. '13-later FXDB models equipped with side-mount license plate requires License Plate Relocation Kit P/N 67900130. All other years and models (except FXDF and FXDWG) require separate purchase of Turn Signal Relocation Kit P/N 68732-02A (Domestic), 68733-02A (International) or Layback License Plate Kit P/N 60215-06. Not for use with Rear Axle Covers on FXDF and FXDWG models.

**E. LEATHER SADDLEBAGS FOR DYNA MODELS**

Styled with sweeping lines to complement the Dyna fender, these bags feature plenty of storage space for a ride to the store or to Sturgis. The rigid plastic tub, wrapped in genuine leather, offers long-term durability. The traditional leather straps hide quick-disconnect closures for packing convenience. Luggage capacity: 2380 cubic inches total.

**79300-06D \$629.95**

Fits '02-later Dyna models (except FLD, '02-'05 FXDWG and '09-later FXDBP with optional chrome or black strut covers). '02-'05 models require separate purchase of Mounting Hardware Kit P/N 92025-09. '09-later FXDB models require separate purchase of Turn Signal Relocation Kit P/N 68227-09. '10-later FXDWG models require separate purchase of Turn Signal Relocation Kit P/N 68544-10. '13-later FXDB models equipped with side-mount license plate requires License Plate Relocation Kit P/N 67900130. All other years and models (except FXDF and FXDWG) require separate purchase of Turn Signal Relocation Kit P/N 68732-02A (Domestic), 68733-02A (International) or Layback License Plate Kit P/N 60215-06. Not for use with Rear Axle Covers on FXDF and FXDWG models.

**F. SYNTHETIC LEATHER SADDLEBAGS**

These synthetic leather saddlebags deliver both style and large capacity at a low cost. The rigid plastic tub is wrapped in synthetic leather for long-term durability. The bag features a large protective lid with hook-and-loop and snap closure and an inner pocket for small item storage. Luggage capacity: 2380 cubic inches total.

**90564-06D \$479.95**

Fits '02-later Dyna models (except FLD, '02-'05 FXDWG and '09-later FXDBP with optional chrome or black strut covers). '02-'05 models require separate purchase of Mounting Hardware Kit P/N 92025-09. '09-later FXDB models require separate purchase of Turn Signal Relocation Kit P/N 68227-09. '10-later FXDWG models require separate purchase of Turn Signal Relocation Kit P/N 68544-10. '13-later FXDB models equipped with side-mount license plate requires License Plate Relocation Kit P/N 67900130. All other years and models (except FXDF and FXDWG) require separate purchase of Turn Signal Relocation Kit P/N 68732-02A (Domestic), 68733-02A (International) or Layback License Plate Kit P/N 60215-06. Not for use with Rear Axle Covers on FXDF and FXDWG models.

NOTE: Some Harley-Davidson® saddlebags are made of leather. Fine leathers or other natural materials WILL gain "character," such as wrinkles or wear, with age. This is normal. A fine, aged patina and character wrinkles are a sign of the extremely high quality materials used to construct your saddlebags. The appearance of scars or marks on the leather are a result of using natural leather panels and should not be thought of as an imperfection. Please use Harley-Davidson Leather Protectant P/N 93600034 to protect your investment.

Notice: The prices appearing in this catalog are the manufacturer's suggested retail prices. Actual retail prices may vary.

# 168 DYNA®

## Saddlebags & Luggage

### A. HARD SADDLEBAGS\*

The Dyna® models are designed to devour miles and these bags add to the appetite. These Hard Saddlebags are lockable and provide secure storage for the road. Using injection-molded construction, these bags offer a fresh, alternative look as compared with their leather cousins. Kit includes Turn Signal Relocation Hardware. Luggage capacity: 2,500 cubic inches total.

Fits '96-later Dyna models (except FXDS-CONV., '00-'03 FXDX, FXDXT, '09-later FXDB, '10-later FXDWG and '12-later FLD). Fits with H-D® Detachables™ or Rigid-Mounted Sissy Bars and Luggage Racks. (Will not fit FXDWG or FXDF models equipped with detachable sideplates.)

<b>90126-00A</b>	Primed.	<b>\$1,249.95</b>
<b>90126-00DH</b>	Vivid Black.	<b>\$1,549.95</b>



A. HARD SADDLEBAGS – (VIVID BLACK SHOWN)

### B. SINGLE-SIDED SWINGARM BAG

Less is more. With enough room for the essentials, these stylish Swingarm Bags eliminate the need to stuff your pockets or bungee a bag across the passenger pillion. Shaped to hug the contour of your bike's frame, these compact bags add an old school look. Bags are constructed of heavyweight leather and feature a pouch-style flap lid that is secured with two quick-disconnect clips that are hidden behind traditional straps and buckles. The semirigid-backed bag is secured to the left side of the bike with easy-to-install brackets and adjustable straps. Bag is available in your choice of rich black leather or brown distressed leather finish. Luggage capacity: 265 cubic inches total.

Fits '06-later Dyna models (except FLD) equipped with Solo Seats. Requires removal of passenger pegs.

<b>90200570</b>	Black Leather.	<b>\$179.95</b>
<b>90200571</b>	Brown Distressed Leather.	<b>\$179.95</b>



B. SINGLE-SIDED SWINGARM BAG – BLACK LEATHER



B. SINGLE-SIDED SWINGARM BAG – BROWN DISTRESSED LEATHER

### C. LEATHER THROW-OVER SADDLEBAGS

These traditional Leather Throw-Over Bags feature large side gussets for increased capacity and full-length straps with hidden quick-disconnect clips for easy access.

<b>91008-82C</b>	<b>\$369.95</b>
------------------	-----------------

Fits '82-later XL (except XL1200T), '08-later Dyna (except FLD) and '84-'99 Softail® models equipped with H-D® Chrome Saddlebag Supports.



C. LEATHER THROW-OVER SADDLEBAG

### D. SYNTHETIC LEATHER THROW-OVER SADDLEBAGS

Synthetic leather with embossed "Eagle Wing" logo. 11.0" W x 10.0" T x 3.75" D.

<b>90570-86TA</b>	<b>\$119.95</b>
-------------------	-----------------

Fits '82-'03 XL, '91-'05 Dyna and '84-'99 Softail models equipped with saddlebag supports.



D. SYNTHETIC LEATHER THROW-OVER SADDLEBAGS

\*NOTE: This product is a "Paint to Order" accessory. Please allow for an average of 5 weeks delivery for this item.

Notice: The prices appearing in this catalog are the manufacturer's suggested retail prices. Actual retail prices may vary.





**E. CHROME SADDLEBAG SUPPORTS**



**F. SADDLEBAG TRAVEL-PAKS  
(91959-97 SHOWN)**



**G. DOWN-TUBE BAG –  
BLACK LEATHER**



**G. DOWN-TUBE BAG –  
BROWN DISTRESSED LEATHER**



**H. UNIVERSAL SADDLEBAG LOCK KIT**



**E. CHROME SADDLEBAG SUPPORTS**

Fits with or without Sissy Bar Uprights, attach easily and protect bags from contacting brake and swingarm.

**90589-91D \$149.95**

Fits '91-'05 Dyna® models (except '93-'95 FXDWG). Also fits '96-'05 FXDWG models. '02-'08 Dyna models require separate purchase of (2) Bullet Turn Signals P/N 68425-01 (Domestic) or 68420-01 (International). '00-'01 FXDX models require the separate purchase of Hardware Kit P/N 90272-00. Does not fit with H-D® Detachables™ sissy bars or racks.

**91017-10 \$155.95**

Fits '08-later Dyna models (except FLD). Does not fit with H-D Detachables sissy bars or racks.

**F. SADDLEBAG TRAVEL-PAKS**

Water-resistant liners make packing easy. Feature inner pockets for extra storage and an embroidered Bar & Shield logo.

**91959-97 \$54.95**

Liner dimensions: 12.0" W x 10.0" T x 5.0" D.

**91486-01 \$49.95**

Fits XL and Dyna models equipped with Color-Matched Hard Saddlebags.

**G. DOWN-TUBE BAG**

The perfect place to store a couple of tools, a tire gauge or your disc lock. The rigid-backed bag features a stylish heavy leather flap and traditional strap-and-buckle closures to provide both function and flair. Easy-to-install, the low frame placement is inconspicuous, but still provides quick access when needed. Kit includes all required mounting hardware.

Fits '04-later XL, XR and '06-later Dyna models (except FLD). Does not fit XL models with engine guard. Does not fit XL models with Boom!™ Audio Cruiser Amp and Speaker Kit P/N 76262-08 or 76320-08. Does not fit Dyna models with evaporative emissions canister (California and AP markets). Does not fit with Dyna Oil Cooler Kit P/N 26151-07. Does not fit XL and Dyna models equipped with Front Spoilers, FXDSE/2 and FXDFSE/2 models require removal of Original Equipment front spoiler.

**93300044 Black Leather. \$129.95**

**93300045 Brown Distressed Leather. \$129.95**

**H. UNIVERSAL SADDLEBAG LOCK KIT**

Keep the contents of your existing soft-sided saddlebags safe from the grab-and-go thief. This unique kit features two extra-small barrel locks that can replace existing saddlebag snaps to perform double duty as locks or as snaps when you don't need to lock your bags. Can be keyed to match your barrel-style ignition key. Sold in pairs.

Fits most soft-sided leather and vinyl saddlebags. Does not fit FLHRC and FLHRS.

**90300003 Keyed To Match. \$59.95**

**90300017 Random Key Code. \$49.95**

**I. AUXILIARY POWER PORT – SADDLEBAG MOUNT**

Charge your cell phone or portable music player from this handy saddlebag-mounted 12-volt power port. Conventional "cigarette lighter" style power outlet accepts most 12V automotive power adaptor plugs and features a flip-top cover to protect the port while not in use.

**69200091 \$40.95**

Fits models equipped with 12-volt battery. Does not fit VRSC™ models, Throw-Over or Swingarm Bags. Not for use with accessory Fitted Liners or Premier Liners. Requires separate purchase of Battery Charging Harness P/N 94624-97B, if not already equipped.

**J. USB CHARGING ADAPTOR**

Charge your cell phone, MP3 players and other hand-held devices while on the road. Compact Adaptor plugs into standard or accessory 12-volt power ports and provides a standard USB-style outlet that accepts many phone and music player power cords.

**69200357 \$19.95**

For use with 12V Auxiliary Power Port.



**I. AUXILIARY POWER PORT –  
SADDLEBAG MOUNT**



**J. USB CHARGING ADAPTOR**

# 170 DYNA®

Fuel Tank Trim

## A. BROWN DISTRESSED LEATHER TANK PANEL

Styled to complement Brown Distressed Leather seats and saddlebags, this tank panel is the perfect choice to complete your vintage western saddle look. Easy-to-install panel features an embossed Bar & Shield logo.

**70900103** **\$59.95**

Fits '00-later Softail® models (except FXCW, FXCWC, FXS, FXSB, FXSBSE, FXSTD, FXSTSSE/2/3, FLS, FLSTFSE2, FLSTNSE, FLSTSB, FLSTSE/2/3 and '09-later FLSTC). Also fits '93-'08 FXDWG, '06 FXD35 and '07-later FXDF and FXDC models. '93-'03 FXDWG models require the separate purchase of Clip P/N 10102 and O-Ring P/N 11174.



A. BROWN DISTRESSED LEATHER TANK PANEL

## B. PREMIUM TANK PANEL WITH POUCH

This leather tank panel features an over-sized pouch for convenient "at your fingertips" storage. The heavy-duty leather pouch will maintain its shape for miles to come while the bold chrome Bar & Shield medallion sits proudly on the flap for all to admire.

**91135-09** **\$99.95**

Fits '00-later Softail models (except FXCW, FXCWC, FXS, FXSB, FXSBSE, FXSTD, FXSTSSE/2/3, FLS, FLSTFSE2, FLSTNSE, FLSTSB, FLSTSE/2/3 and '09-later FLSTC). Also fits '93-'08 FXDWG, '06 FXD35 and '07-later FXDF and FXDC models. '93-'03 FXDWG models require the separate purchase of Clip P/N 10102 and O-Ring P/N 11174.



B. PREMIUM TANK PANEL WITH POUCH



C. LEATHER TANK PANEL WITH TEARDROP CONCHO AND POUCH

## C. LEATHER TANK PANEL WITH TEARDROP CONCHO AND POUCH

Stylish leather tank panel puts a convenient storage pouch right at your fingertips. Embossed basket-weave pattern and bright chrome teardrop concho matches the Softail Springer™ Classic trim and complements other smooth leather and vinyl seats and bags.

**91469-06** **\$99.95**

Fits '00-later Softail models (except FXCW, FXCWC, FXS, FXSB, FXSBSE, FXSTD, FXSTSSE/2/3, FLS, FLSTFSE2, FLSTNSE, FLSTSB, FLSTSE/2/3 and '09-later FLSTC). Also fits '93-'08 FXDWG, '06 FXD35 and '07-later FXDF and FXDC models. '93-'03 FXDWG models require the separate purchase of Clip P/N 10102 and O-Ring P/N 11174.

## D. LEATHER TANK PANEL WITH POUCH

Leather tank panels feature an integrated storage pouch, perfect for those small items you like to keep handy. Constructed of tough steerhide over a rigid, molded base.

Fits '93-'03 FXDWG and '00-later Softail models (except FXCW, FXCWC, FXS, FXSB, FXSBSE, FXSTD, FXSTSSE/2/3, FLS, FLSTFSE2, FLSTNSE, FLSTSB, FLSTSE/2/3 and '09-later FLSTC).

**91409-00** Braided Trim & Concho. **\$99.95**

**91407-00** Chrome Studs & Concho. **\$99.95**

**91408-00** Braided Flap & Concho. **\$99.95**



D. LEATHER TANK PANEL WITH POUCH – BRAIDED TRIM AND CONCHO



D. LEATHER TANK PANEL WITH POUCH – CHROME STUDS AND CONCHO

## E. LEATHER TANK PANEL WITH EMBOSSED SKULL LOGO

Add a little menace to your bike with this skull-embossed leather tank panel.

**91001-01** **\$49.95**

Fits '93-'03 FXDWG and '00-later Softail models (except FXCW, FXCWC, FXS, FXSB, FXSBSE, FXSTD, FXSTSSE/2/3, FLS, FLSTFSE2, FLSTNSE, FLSTSB, FLSTSE/2/3 and '09-later FLSTC).



D. LEATHER TANK PANEL WITH POUCH – BRAIDED FLAP AND CONCHO



E. LEATHER TANK PANEL WITH EMBOSSED SKULL LOGO

*Notice: The prices appearing in this catalog are the manufacturer's suggested retail prices. Actual retail prices may vary.*





**F. DASH PANEL EXTENSION – CHROME**  
(71282-04 SHOWN)



**F. DASH PANEL EXTENSION – CHROME**  
(71284-01 SHOWN)

**F. DASH PANEL EXTENSION – CHROME**

Stretch the lines of your chrome dash panel the full length of the fuel tank. This chrome-plated trim kit continues the lines and finishes of your standard tank panel to the front of the seat. The curving lines and Bar & Shield logo add a custom touch without the expense of a custom tank.

**71282-04** **\$42.95**  
Fits '04-'08 FXDWG, '06 FXD35, '07-'11 FXDC and '08-'13 FXDF models.

**71284-01** Fits '95-'03 FXDWG models. **\$41.95**

**G. CONSOLE KIT – CHROME**

Replace the wrinkle black console with a sweep of chrome. Manufactured to Original Equipment specifications, this mirror-chrome dash panel fits like a glove around the stock fuel cap and fuel gauge. Kit includes chrome-plated stainless steel mounting hardware.

**67188-04** **\$149.95**  
Fits '04-'10 FXD, FXDX and '04-'06 FXDC models.

**H. CONSOLE KIT FOR DYNA® LOW RIDER® MODELS – CHROME**

Replace the standard black console with a sweep of chrome. Manufactured to Original Equipment specifications, this mirror-chrome dash panel fits like a glove around the stock speedometer and tachometer gauges. Kit includes chrome-plated stainless steel mounting hardware.

**67187-04** Fits '04-'09 FXDL models. **\$174.95**

**I. INSTRUMENT HOUSING AND FUEL TANK TRIM PANEL – CHROME**

Give the custom look of chrome to the fuel tank on Dyna® Low Rider® models. (Instrument housing and trim panel sold separately.)

**1. Instrument Housing**  
**67189-95** Fits '95-'03 FXDL models. **\$99.95**

**2. Chrome Fuel Tank Trim Panel**  
**61655-91** Fits '91-'03 FXDL models. **\$149.95**



**G. CONSOLE KIT – CHROME**



**I. INSTRUMENT HOUSING AND FUEL TANK TRIM PANEL – CHROME**



**H. CONSOLE KIT FOR DYNA LOW RIDER MODELS – CHROME**



*Notice: The prices appearing in this catalog are the manufacturer's suggested retail prices. Actual retail prices may vary.*

# 172 DYNA®

## Chassis Trim

### A. COIL COVER – CHROME

This sleek, Chrome Coil Cover features an innovative design that conceals all the mounting hardware. It offers a great, easy way to customize a very visible part of your Dyna® motorcycles.

**31709-04** **\$39.95**  
Fits '04-later fuel-injected Dyna models.

### B. BAR & SHIELD LOGO COIL COVER

Featuring a radical open-face design with a Bar & Shield silhouette, this Chrome Coil Cover matches the Chrome Voltage Regulator Cover for an integrated custom look. Includes all mounting hardware.

**74616-04** **\$39.95**  
Fits '01-later EFI equipped Softail® models (except FXCW, FXCWC, FXS, FXSB, FXSBSE and FXST-Aus) and '04-later EFI equipped Dyna models.

### C. VOLTAGE REGULATOR COVER

Designed for up-front style, the open face and floating Bar & Shield logo on this chrome cover provide good looks without compromising air flow across the voltage regulator. Kit includes chrome-plated mounting hardware.

**74667-06** **\$44.95**  
Fits '06-'11 Dyna models.

**74665-04** **\$44.95**  
Fits '04-'05 FXDL and FXDWG models.

### D. VOLTAGE REGULATOR COVER

With looks that create their own electricity, this chrome-plated cover features an embossed Bar & Shield logo and an open-center grill that allows air to flow through for regulator cooling. Designed for easy installation. Chrome mounting hardware included.

**74577-97** **\$44.95**  
Fits '91-'03 Dyna models.

### E. BATTERY & ELECTRICAL PANEL COVER KIT – CHROME

Dress your bike with a new chrome skin. This two-piece kit replaces the painted battery and electrical panel covers and adds a bright contrast to the motorcycle's profile. Add your choice of accessory Battery Cover Band Trim (sold separately) for a finishing touch.

**61300186** **\$159.95**  
Fits '12-later Dyna models.

### F. ELECTRICAL PANEL TRIM – CHROME

This sweeping chrome spear adds a mirror-polished accent to your bike's profile. The easy-to-install band is a high-contrast addition to the Original Equipment painted electrical panel cover or the perfect finishing touch on a Chrome Cover.

**66462-07** **\$44.95**  
Fits '04-later Dyna models (except FXDL, '06 FXD35 and '04-'08 FXDWG models with Original Equipment electrical panel cover).

### G. ELECTRICAL PANEL COVER WITH TRIM – CHROME

Chrome-plated Electrical Panel Cover with concealed mounting hardware provides a nice clean look. Kit includes panel cover, distinctive chrome-plated die-cast trim with black accented lines and Bar & Shield logo and all necessary mounting hardware.

**66426-04** **\$84.95**  
Fits '04-'11 Dyna models.



A. COIL COVER – CHROME



B. BAR & SHIELD LOGO COIL COVER



C. VOLTAGE REGULATOR COVER



D. VOLTAGE REGULATOR COVER



E. BATTERY & ELECTRICAL PANEL COVER KIT – CHROME



F. ELECTRICAL PANEL TRIM – CHROME



G. ELECTRICAL PANEL COVER WITH TRIM – CHROME

*Notice: The prices appearing in this catalog are the manufacturer's suggested retail prices. Actual retail prices may vary.*





**H. BATTERY COVER – CHROME**



**I. BATTERY COVER BAND – CHROME**



**J. BATTERY COVER BAND – “HARLEY-DAVIDSON” SCRIPT**



**K. BATTERY COVER BAND – SKULL**



**L. BATTERY COVER**



**M. BATTERY SIDE COVER – CHROME**



**N. CHROME BATTERY COVERS**



**O. CHROME BATTERY TOP COVER**

**H. BATTERY COVER – CHROME**

Dress your battery with a new chrome skin. This one-piece Chrome Battery Cover replaces the painted box and adds a bright contrast to the Original Equipment satin aluminum trim band.

**66375-06** **\$79.95**  
Fits '06-later Dyna® models. '14-later Dyna models require purchase of a battery cover trim band.

**I. BATTERY COVER BAND – CHROME**

This sweeping chrome band replaces the Original Equipment satin-finish band for a mirror-polished look. The easy-to-install ribbed chrome band is a high-contrast addition to a painted battery cover or the perfect finishing touch to the Chrome Battery Cover P/N 66375-06.

**66439-07** **\$33.95**  
Fits '06-later Dyna models (except FLD, FXDL, '13-later FXDB and '14-later FXDF). Also fits models equipped with Battery and Electrical Panel Cover Kit P/N 61300186.

**J. BATTERY COVER BAND – “HARLEY-DAVIDSON” SCRIPT**

Replace the Original Equipment satin aluminum trim band with a splash of chrome. This easy-to-install custom contoured trim band features a black-filled embossed “Harley-Davidson” script design and offers a stunning contrast to the factory painted battery cover or a great finishing touch for the Chrome Battery Cover P/N 66375-06 or 61300186.

**66443-06** **\$39.95**  
Fits '06-later Dyna models (except FLD, FXDL, '13-later FXDB and '14-later FXDF). Also fits models equipped with Battery and Electrical Panel Cover Kit P/N 61300186.

**K. BATTERY COVER BAND – SKULL**

Add a sinister touch to your Dyna motorcycle. This easy-to-install chrome band features a 3-dimensional skull design set off with black accents. Designed to replace the Original Equipment satin aluminum band, this chrome skull trim offers a stunning contrast to the factory painted battery cover or a great finishing touch for the Chrome Battery Cover P/N 66375-06.

**66442-06** **\$39.95**  
Fits '06-later Dyna models (except FLD, FXDL, '13-later FXDB and '14-later FXDF). Also fits models equipped with Battery and Electrical Panel Cover Kit P/N 61300186.

**L. BATTERY COVER**

This one-piece, chrome-plated Battery Cover has the top and side cover all-in-one. Bottom of cover is accented with a gloss black decal with Bar & Shield logo.

**66192-99** Fits '91-'05 Dyna models. **\$54.95**

**M. BATTERY SIDE COVER – CHROME**

This chrome-plated cover is designed for use with the new Harley-Davidson® AGM sealed maintenance-free batteries and can be used in combination with Battery Top Cover P/N 66367-97 or 66368-97.

**66718-01** **\$49.95**  
Fits '97-'03 XL models and '97-'05 Dyna models.

**N. CHROME BATTERY COVERS\***

Chrome-plated battery enclosures include slotted openings for convenient visual check of battery fluid levels. Easy installation.

**1. 66375-97** Chrome. **\$59.95**  
Fits '97-'05 FXD/X/XT models. Stock on FXDL, FXDWG and FXDS-CONV. models.

**2. 66340-78** Chrome Vented. **\$49.95**  
Fits '82-'03 XL models, electric start FX, FXWG models and '91-'96 Dyna models.

**3. 66358-83** U.S.A. Eagle. **\$59.95**  
Fits '82-'03 XL models, electric start FX, FXWG models and '91-'96 Dyna models.

\*NOTE: Battery dimensions of Harley-Davidson AGM Batteries P/N 65989-97A, 65989-90B and 65991-82B may not allow use of accessory battery side covers on XL and Dyna models.

**O. CHROME BATTERY TOP COVER**

Turn black to chrome with this easy-to-install cover.

**66368-97** Fits '97-'05 Dyna models. **\$54.95**

## A STRONG FOUNDATION

Being sure-footed at a stop or when parking your bike enhances your feeling of control and confidence. Adjusting the ride height by lowering the suspension may be the first step in fitting the bike to your inseam length. Combining a low-profile suspension and a narrow seat is the easiest way for a shorter rider to fit comfortably on a larger bike.



### SUSPENSION

While most current Dyna® models are already equipped with low-profile suspension, Harley offers model-specific suspension options to improve your ride comfort.

## ESTABLISH YOUR POSITION



### HANDLEBARS

Where the bar positions your hands, wrists and arms directly affects how you feel on the motorcycle. The shape of the bar determines your reach to the hand controls and, therefore, your overall comfort.



### SEATS

The right seat is equal parts ergonomics and comfort. Its shape anchors your position and determines the reach to the ground and to the controls and the padding supports your tailbone and hips to relieve stress and pressure. Pick the right one for you – and your passenger.



### FOOT CONTROLS

Where your feet contact the controls can often determine how many miles you can put on in a day. Mid-controls position your feet below the knee for a sporting riding posture, while forward controls stretch your legs for a relaxed, laid-back posture. For more details, visit [h-d.com/fitshop](http://h-d.com/fitshop).

THE FIT SHOP LIST	2015	SUSPENSION	SEATS	HANDLEBARS	FOOT SUPPORTS
 <p>Here are a few options to consider when outfitting your bike to fit you. Find your model and flip to the pages for more information. For more details, visit <a href="http://h-d.com/fitshop">h-d.com/fitshop</a>.</p>	FLD	Low Suspension is Stock	Reduced Reach® Seats Brawler®/Sidekick® Seats Road Zeppelin® Seat Tallboy® Seat	Extreme Reduced Reach Bar Fat 12" or 16" Ape Bar Beach Bar Narrow Beach Bar Street Slammer Bar	Adjustable Passenger Pegs
	FXDL	Low Suspension is Stock	Reduced Reach Seats Brawler /Sidekick Seats Road Zeppelin Seat Tallboy Seat	Extreme Reduced Reach Bar	Forward Control Kit Reduced Reach Forward Controls Adjustable Highway Pegs
	FXDB	Low Suspension is Stock	Reduced Reach Seats Brawler /Sidekick Seats Road Zeppelin Seat Tallboy Seat	Extreme Reduced Reach Bar Fat Drag Bar Beach Bar Hollywood Bar Chizeled Bar Fat 12" or 16" Ape Bar Street Slammer Bar	Forward Control Kit Reduced Reach Forward Controls Further Forward Mid-Controls Rider Footboards Adjustable Highway Pegs
	FXDF	Profile® Low Front Suspension	Reduced Reach Seats Brawler /Sidekick Seats Road Zeppelin Seat Tallboy Seat	Extreme Reduced Reach Bar Fat Drag Bar Beach Bar Fat 12" or 16" Ape Bar Street Slammer Bar	Reduced Reach Forward Controls Adjustable Passenger Pegs
	FXDWG	Low Suspension is Stock	Reduced Reach Seats Brawler /Sidekick Seats Road Zeppelin Seat Tallboy Seat	Extreme Reduced Reach Bar Drag Bar Beach Bar Hollywood Bar Fat 12" or 16" Ape Bar Street Slammer Bar	Reduced Reach Forward Controls Adjustable Passenger Pegs





### A. PROFILE® LOW FRONT SUSPENSION – FXDF\*

Designed by Harley-Davidson to lower the front fork approximately 1.0" while preserving ride quality. Springs are wound to allow a compliant, yet controlled ride. A perfect addition during the installation of chrome or gloss black lower fork sliders, the kit includes two fork springs, two damper tubes and two spring collars.

**54676-09** **\$104.95**  
Fits '08-later FXDF models. Stock on FXDFSE/2 models.

### B. PROFILE LOW FRONT SUSPENSION – FXDWG\*

Designed by Harley-Davidson to lower the front fork approximately 1.0" while preserving ride quality. A perfect addition during the installation of chrome or gloss black lower fork sliders, the kit includes springs that are progressively wound for a compliant, yet controlled ride. Must only be installed on vehicles equipped with low-profile rear suspension.

**54621-05** **\$104.95**  
Fits '00-later FXST, FXSTB and FXSTC models equipped with Profile® Low Rear Suspension P/N 54648-00A, 54665-03, 54651-05A, 54652-05 or Rear Lowering Kit P/N 54001-04A. Also fits '00-'05 FXDWG models equipped with Low Rear Shock Kit P/N 54594-03 or Premium Billet Profile Low Rear Suspension P/N 54592-03.

### C. PROFILE LOW REAR SHOCK KIT\*

Plant your feet firmly on the ground. This reduced length version of the Original Equipment rear suspension lowers the seat height by approximately 1.0". Shocks feature chrome-plated springs and body caps and suspension preload is adjustable for rider and passenger load.

**54625-06** **\$239.95**  
Fits '06-'09 FXD, FXDC and FXDWG models. (Lowers '06-'09 FXDL, '08-'09 FXDF and FXDB models 1/4".) Does not lower '10-later Dyna® models.

**54594-03** **\$239.95**  
Fits '93-'05 FXD, FXDL, FXDC and FXDWG models. Does not lower '01-'05 FXDL models.

### D. PREMIUM PROFILE LOW REAR SUSPENSION KIT\*

Introduced on the '08 FXDF model, these custom rear shocks lower your bike while they raise the level of style. These low-profile shocks lower the seat height by approximately 1.0". The rear shock and spring is completely covered with mirror-polished and chrome-plated sleeves for a sleek, beefy look.

**54619-08** **\$429.95**  
Fits '07-later FXD, FXDC and FXDWG models. Stock on '08-later FXDF. Fits but does not lower '07-later FXDL, FXDB and '10-later FXD, FXDC and FXDWG models. '07 Dyna models require separate purchase of Chrome Belt Guard Kit P/N 60633-08. Does not fit with H-D® Detachables™ Saddlebags P/N 90181-08.



**A. PROFILE LOW FRONT SUSPENSION – FXDF MODELS**

**B. PROFILE LOW FRONT SUSPENSION – FXDWG MODELS**



**C. PROFILE LOW REAR SHOCK KIT**

**D. PREMIUM PROFILE LOW REAR SUSPENSION KIT**



**\*WARNING:** Installation of any accessory suspension components may affect cornering clearance and jiffy stand operation. This could distract the rider, causing loss of control and death or serious injury.



**\*WARNING:** The Profile Low Front Spring Kit cannot be used independently and must be used with the appropriate Profile Rear Shock Lowering Kit. Installation of any accessory suspension components may affect cornering clearance and jiffy stand operation. This could distract the rider, causing loss of control and death or serious injury.

*Notice: The prices appearing in this catalog are the manufacturer's suggested retail prices. Actual retail prices may vary.*

# 176 DYNA®

## Foot Controls

### A. STANDARD FORWARD CONTROLS\*

Stretch out for maximum comfort and style. This complete kit includes all components necessary to convert a mid-control equipped Dyna® model to forward controls. Moves controls 11.0" forward from mid-control foot position.

Fits '06-later Dyna models with mid-controls. FLD models require separate purchase of footpegs.

<b>49080-06A</b>	Chrome.	<b>\$369.95</b>
<b>49021-09</b>	Gloss Black.	<b>\$369.95</b>

Fits '93-'05 Dyna models. Stock on '03-'05 FXDWG models. Not for use with Engine Guard on FXD and FXDL models.

<b>49080-03A</b>	Chrome.	<b>\$369.95</b>
------------------	---------	-----------------

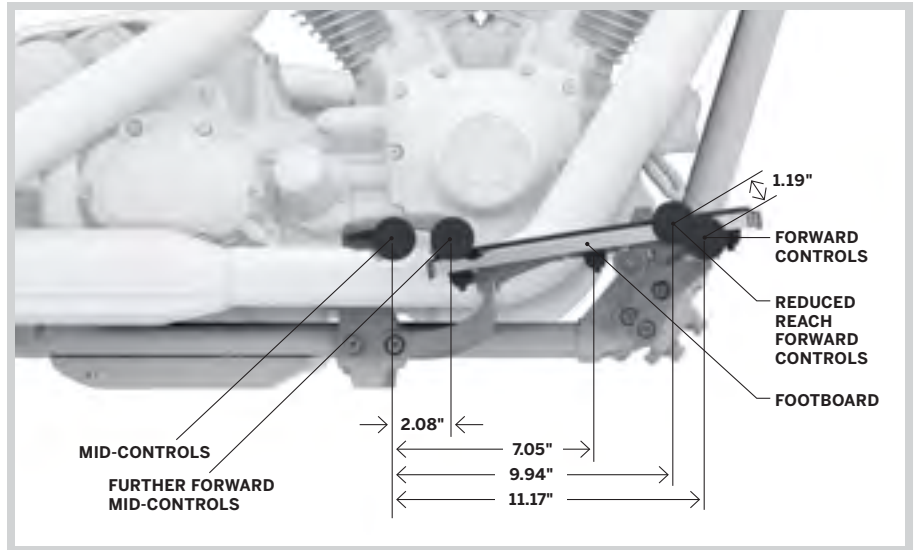

**FOOT CONTROL POSITION COMPARISON**



**A. STANDARD FORWARD CONTROLS  
(SHOWN WITH OPTIONAL BILLET STYLE BRAKE LEVER)**



**A. STANDARD FORWARD CONTROLS –  
CHROME**



**A. STANDARD FORWARD CONTROLS –  
GLOSS BLACK**



**\*WARNING:** Installation of accessory Forward Control Kits may affect cornering clearance. This could distract the rider, causing loss of control, resulting in death or serious injury.

*Notice: The prices appearing in this catalog are the manufacturer's suggested retail prices. Actual retail prices may vary.*





**B. REDUCED REACH FORWARD CONTROL CONVERSION KIT (SHOWN WITH OPTIONAL BILLET STYLE BRAKE LEVER)**

**B. REDUCED REACH FORWARD CONTROL CONVERSION KIT\***

Love the look and riding position you get with forward controls but not comfortable with the long stretch forward? This Forward Control Conversion Kit repositions the Original Equipment footpegs and foot controls up and back by over 1.0", positioning the controls closer to the rider for added comfort and confidence. The reduced reach places the rider's boot at the proper pivot point for improved leverage, while maintaining the "foot-forward" riding profile. This easy-to-install Conversion Kit includes heavy-duty steel mounts and shortened brake rod and reuses Original Equipment control supports and brake and shift levers or can be personalized with your choice of custom lever styles.

**50700005** **\$169.95**  
Fits '06-later Dyna® models (except FLD) equipped with forward controls.



**B. REDUCED REACH FORWARD CONTROL CONVERSION KIT**

**C. REDUCED REACH FORWARD CONTROL KIT\***

Want to stretch the riding position of your mid-control equipped model, but not comfortable with the long reach to factory-position forward controls? This complete kit is the perfect alternative. It positions the feet up and forward 10.0" from the mid-control position, but 1.0" closer to the rider than the standard position factory forward controls, placing the rider's boot at a comfortable pivot point for improved support and leverage. Available in chrome or gloss black finish, the kit includes left and right footpeg supports, brake and shift lever assemblies, brake and shift linkages and all required hardware.

Fits '06-later Dyna models equipped with mid-controls. FLD models require separate purchase of footpegs.

<b>50700007</b>	Gloss Black.	<b>\$399.95</b>
<b>50700008</b>	Chrome.	<b>\$399.95</b>



**C. REDUCED REACH FORWARD CONTROL KIT – CHROME**



**C. REDUCED REACH FORWARD CONTROL KIT – GLOSS BLACK**



**\*WARNING:** Installation of accessory Forward Control Kits may affect cornering clearance. This could distract the rider, causing loss of control, resulting in death or serious injury.

*Notice: The prices appearing in this catalog are the manufacturer's suggested retail prices. Actual retail prices may vary.*

# 178 DYNA®

## Foot Controls

### A. FURTHER FORWARD MID-CONTROL KIT

Feel a little cramped when your feet are placed on the standard-location mid-controls? This kit repositions the controls 2.0" forward of the stock location, eliminating the "knees-high" riding attitude while maintaining a sporty upright riding posture. The forward location provides an open path for your feet to aid maneuvering the bike while parking and improves access to the jiffy stand for a shorter rider. Kit includes chrome left and right footrest brackets, highly polished brake lever and chrome shift lever. Use stock footpegs, brake and shift linkages or, choose from other Dyna® collection offerings to complete your look.

**50500386** **\$319.95**

Fits '06-later Dyna models with mid-controls. Original Equipment on '14-later FXDL models.



**A. FURTHER FORWARD MID-CONTROL KIT – RIGHT SIDE**



**A. FURTHER FORWARD MID-CONTROL KIT – LEFT SIDE**

### B. RIDER FOOTBOARD KIT

Convert your Dyna model to touring-oriented footboard-based controls. Ideal for riders with an inseam too long for mid-controls or for riders who prefer the extra foot room on long rides, this complete kit moves the foot brake and shift lever forward from the standard position. The installation places the rider into a comfortable upright posture with a flat foot and bent knee profile. This position provides additional support by allowing the legs to take some of the rider's weight, while providing the freedom to reposition the feet during the ride. The kit includes left and right footboards with inserts, footboard supports, brake lever, brake and shift linkage, brake pedal pad and all required hardware. Installation reuses Original Equipment shift lever. Customize the look by adding your choice of accessory traditional D-shaped rider footboard inserts and large brake pedal pads.

**50500247** **\$399.95**

Fits '06-later FXD, FXDB, FXDC and '06-'13 FXDL models. Also fits '06-'08 FXDWG models. Stock on '12-later FLD models. Not for use with frame-mounted highway pegs.



**B. RIDER FOOTBOARD KIT – LEFT SIDE**



**B. RIDER FOOTBOARD KIT – RIGHT SIDE**



**B. RIDER FOOTBOARD KIT**

*Notice: The prices appearing in this catalog are the manufacturer's suggested retail prices. Actual retail prices may vary.*





**C. ADJUSTABLE HIGHWAY PEG MOUNTING KIT**



**C. ADJUSTABLE HIGHWAY PEG MOUNTING KIT\***

Versatility with style and comfort. Choose from several H-D® custom footpegs to complete the cruiser look. Easy to install.

**49002-98 \$149.95**

Fits Dyna® models with Original Equipment mid-controls or Further Forward Mid-Control Kit P/N 50500386. Will not fit models equipped with engine guards.

**D. HIGHWAY PEG MOUNTING KIT\***

Kick back and cruise. Kit includes chrome mounting plates, chrome footpeg supports and all necessary mounting hardware. Uses H-D® male-mount footpegs.

**49019-95 \$149.95**

Fits Dyna models with Original Equipment mid-controls or Further Forward Mid-Control Kit P/N 50500386. Will not fit models equipped with engine guards.

**E. RIDER FOOTPEG HEEL RESTS**

Give your feet a rest while you're stretching out on your forward controls. These adjustable billet-style Rider Footpeg Heel Rests reduce fatigue and make you look as good as you feel. Just add a pair of matching shifter pegs to complete the custom look (sold separately).

**50227-01 \$124.95**

Fits '93-'02 FXDWG and '89-later FX Softail® models. Also fits Dyna models equipped with Forward Control Kit P/N 49080-06A, 49021-09 or 49080-93A.



**D. HIGHWAY PEG MOUNTING KIT**



**E. RIDER FOOTPEG HEEL RESTS**

**F. JIFFY STAND EXTENSION KIT**

Jiffy Stand Extension kits have been ergonomically designed to simplify the deployment and retraction of the jiffy stand. The extension is shaped to simplify locating the tab with your boot and aid in swinging the jiffy stand into position. The move feels natural and adds confidence when parking your motorcycle in a tight spot. Kit mounts to Original Equipment jiffy stand and includes all required mounting hardware.

**5000032 \$39.95**

Fits '93-later Dyna models (except FXDX/T, FXDS-CONV., '01-'04 FXDL, FXDWG2/3, FXR2/3/4, FXDSE/2 and FXDFSE/2).

**G. RIDER FOOTBOARD HEEL GUARD**

Avoid damaged boots and hours of cleaning melted rubber scuff marks from your exhaust shield. This Heel Guard mounts to the right-side rider footboard and protects your boot from contact with the hot exhaust shield. The subtle curved shape keeps the boot heel away without restricting fore-and-aft movement of the rider's foot. Kit includes chrome guard with cutaway Bar & Shield logo and all mounting hardware.

**50500225 \$64.95**

Fits '12-later FLD, '86-later FL Softail, '86-later Touring and '09-later Trike models equipped with Traditional and Swept Wing footboards. Does not fit models equipped with Half-Moon, Tapered or Burst footboards, Extended Reach Rider Footboards P/N 50409-04 or 54145-10, Rider Running Boards P/N 50500158 or Screamin' Eagle® Fat Exhaust Shield Kits.



**F. JIFFY STAND EXTENSION KIT**



**G. RIDER FOOTBOARD HEEL GUARD**



**\*WARNING:** Do not use highway pegs under normal stop and go operating conditions. Doing so could result in death or serious injury.

Notice: The prices appearing in this catalog are the manufacturer's suggested retail prices. Actual retail prices may vary.

# 180 DYNA®

## Foot Controls

### A. BILLET STYLE REAR BRAKE LEVER

Styled to complement our billet style mirror stems and hand and foot controls, these slotted Rear Brake Levers are forged from 2014-T6 aluminum, then machined and polished for a beautiful, custom look. Available in your choice of mirror chrome, satin black powder coat or edge cut black anodized and machined aluminum finishes. Brake Pedal Pads sold separately.

Fits '03-later Dyna® models equipped with forward controls.

<b>42666-03</b>	Chrome.	<b>\$139.95</b>
<b>41600003</b>	Edge Cut.	<b>\$139.95</b>
<b>46873-09</b>	Satin Black.	<b>\$139.95</b>

### B. BILLET STYLE SHIFT LEVER

Styled to complement our billet style mirror stems, these Billet Style Shift Levers are forged from 6061-T6 aluminum, then machined and finished in chrome, satin black or edge cut styles for a beautiful, custom look. Includes chrome hardware.

Fits '91-later Dyna (except '14-later FXDL or models equipped with Further Forward Mid-Control Kit P/N 50500386) and '90-later FX Softail® models.

<b>34539-00</b>	Chrome.	<b>\$89.95</b>
<b>34043-10</b>	Edge Cut.	<b>\$89.95</b>
<b>34016-08</b>	Satin Black.	<b>\$89.95</b>



A. BILLET STYLE REAR BRAKE LEVER – CHROME



B. BILLET STYLE SHIFT LEVER – CHROME



A. BILLET STYLE REAR BRAKE LEVER – EDGE CUT



B. BILLET STYLE SHIFT LEVER – EDGE CUT



A. BILLET STYLE REAR BRAKE LEVER – SATIN BLACK



B. BILLET STYLE SHIFT LEVER – SATIN BLACK

*Notice: The prices appearing in this catalog are the manufacturer's suggested retail prices. Actual retail prices may vary.*





**C. SHIFTER LINKAGE COVER – “HARLEY-DAVIDSON” SCRIPT**

**C. SHIFTER LINKAGE COVER – “HARLEY-DAVIDSON” SCRIPT**

A simple and inexpensive way to detail your Dyna® model. This easy-to-install chrome-plated cover conceals the stock shifter linkage for a brilliant finish. Kit includes all necessary mounting hardware.

**33878-04** **\$49.95**  
 Fits '97-'05 FXDWG and '93-'05 Dyna models equipped with Forward Control Kit P/N 49080-03.

**D. CUSTOM GEAR SHIFT LINKAGES**

Kick your custom into gear with this collection of high-quality custom shift linkages. Available in a variety of designs to match your bike's style, these linkages feature aircraft-quality rod ends for easy adjustment and smooth operation. The easy-to-install linkage kit includes a transmission lever cover and decorative acorn nuts and bolts for a complete custom look.

Fits '06-later Dyna® models equipped with forward controls.

- |                    |                                 |                 |
|--------------------|---------------------------------|-----------------|
| <b>1. 33900103</b> | Silencer Brushed Nickel.        | <b>\$129.95</b> |
| <b>2. 33917-09</b> | Diamond Black.                  | <b>\$129.95</b> |
| <b>3. 33745-09</b> | Black Anodized Slotted.         | <b>\$129.95</b> |
| <b>4. 34848-09</b> | Skull.                          | <b>\$129.95</b> |
| <b>5. 33838-09</b> | Flame.                          | <b>\$149.95</b> |
| <b>6. 33761-09</b> | Slotted with Bar & Shield Logo. | <b>\$129.95</b> |



**D. CUSTOM GEAR SHIFT LINKAGES**

**E. POLISHED SHIFT LINKAGE**

Replace your zinc-plated Original Equipment shift linkage with this polished stainless steel linkage.

**33872-06** **\$84.95**  
 Fits '06-later Dyna models equipped with mid-controls.

**F. REAR MASTER CYLINDER COVER – CHROME**

An easy way to add chrome to your bike with this chrome-plated version of the stock master cylinder cover.

**46425-05A** **\$39.95**  
 Fits '06-later Dyna non-ABS models, Softail® and '05-'07 Touring Models.



**E. POLISHED SHIFT LINKAGE**



**F. REAR MASTER CYLINDER COVER – CHROME**

*Notice: The prices appearing in this catalog are the manufacturer's suggested retail prices. Actual retail prices may vary.*

# 182 DYNA®

## Foot Controls

### A. PASSENGER FOOTPEG SUPPORT KIT – WRINKLE BLACK

Add footpegs to your solo seat-equipped Dyna® motorcycle. Kit includes wrinkle black finished left and right footpeg supports and mounting hardware. Footpegs and footpeg hardware sold separately.

**50210-06** Fits '06-later Dyna models. **\$74.95**

### B. PASSENGER FOOTPEG SUPPORT KIT – CHROME

These chrome-plated supports add a touch of style to your Dyna motorcycle. Kit includes left and right supports. Footpegs and footpeg hardware sold separately.

**49249-06** Fits '06-later Dyna models. **\$129.95**

### C. PASSENGER FOOTBOARD SUPPORT KIT

Add the comfort and convenience of passenger footboards to your Dyna motorcycle. This Support Kit is designed to allow installation of Traditional D-Shaped, Swept Wing, Tapered or Old-Style Passenger Footboards (sold separately) on Dyna models. Kit includes left and right supports, footboard mount hinge pins and installation hardware.

Fits '06-later Dyna models.

**49279-06** Chrome. **\$239.95**

**49349-07** Black. **\$199.95**

### D. ADJUSTABLE PASSENGER FOOTPEG MOUNT KIT

Maximize your passenger's riding comfort. Proper foot position reduces the cramped or stretched-out feeling and relieves pressure on the knees and the tail bone. These Adjustable Mounts raise and lower the passenger footpeg to accommodate taller and shorter passengers. Easy to adjust with common tools, the mount adjusts through a 360° range (depending on model), allowing both fore and aft and up and down height adjustment. Kit includes left and right adjustable support assembly and all required mounting hardware. Footpegs sold separately.

**50763-09** **\$149.95**

Fits models with H-D male-mount style passenger footpeg supports (except Softail® models). Does not fit with Heel Raiser Footpeg Kit P/N 50178-09. Does not fit the rider position.



A. PASSENGER FOOTPEG SUPPORT KIT – WRINKLE BLACK



B. PASSENGER FOOTPEG SUPPORT KIT – CHROME



C. PASSENGER FOOTBOARD SUPPORT KIT – BLACK



C. PASSENGER FOOTBOARD SUPPORT KIT – CHROME



D. ADJUSTABLE PASSENGER FOOTPEG MOUNT KIT



**\*WARNING:** Do not use highway pegs under normal stop and go operating conditions. Doing so could result in death or serious injury.

Notice: The prices appearing in this catalog are the manufacturer's suggested retail prices. Actual retail prices may vary.





**E. MINI FOOTBOARD KIT – (LARGE CHROME SHOWN)**

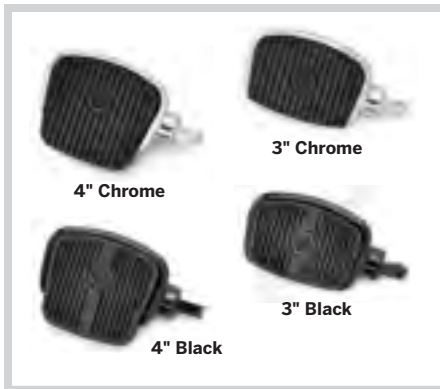

**E. MINI FOOTBOARD KIT**

**E. MINI FOOTBOARD KIT**

This Footboard Kit can be installed in place of traditional footpegs and provides a little additional leg support and more options to move your legs around on a long ride. Mini Footboards mount to the standard H-D® style footpeg supports and can be used in many rider, passenger and highway peg applications. Sole-gripping rubber complements Original Equipment or accessory footboards and footpegs and adds vibration isolation and a rich appearance.

**Fits rider position:**

VRSC™ models with forward controls (except VRSCDX and VRSCF), '06-earlier XL, '07-'10 XL883, XL883R, XL883C, XL1200C, XL1200R and '07-'11 XL1200L, Dyna® models (except FLD) and Softail® models with forward controls (except FXCW, FXCWC, FXS, FXSB or FXSBSE).

**Fits passenger position:**

All models with H-D male-mount passenger peg mounts (except '06-earlier VRSC, '03-earlier XL, '05-earlier Dyna and Softail models equipped with Shotgun exhaust). Softail models require separate purchase of Support Kit P/N 50454-09.

**Fits highway peg position:**

All models with frame-mount or engine guard-mount highway pegs (except Whiskers Adjustable Highway Bar P/N 50855-09 and 50865-09).

<b>50500139</b>	Small 3.0" – Chrome.	<b>\$129.95</b>
<b>50500144</b>	Small 3.0" – Gloss Black.	<b>\$129.95</b>
<b>50500109</b>	Large 4.0" – Chrome.	<b>\$129.95</b>
<b>50500124</b>	Large 4.0" – Gloss Black.	<b>\$129.95</b>

**F. PASSENGER FOOTBOARD PANS – CHROME**

Replace the factory black painted passenger footboard with the custom look of smooth chrome. The kit includes left- and right-hand traditional D-shaped footboard pans, chrome-plated and ready to install with your Original Equipment hardware. Footboard inserts and footboard supports sold separately.

**50752-04**

**\$169.95**

Fits '86-later Touring and Trike, '00-later Softail and '06-later Dyna models equipped with passenger footboard supports.

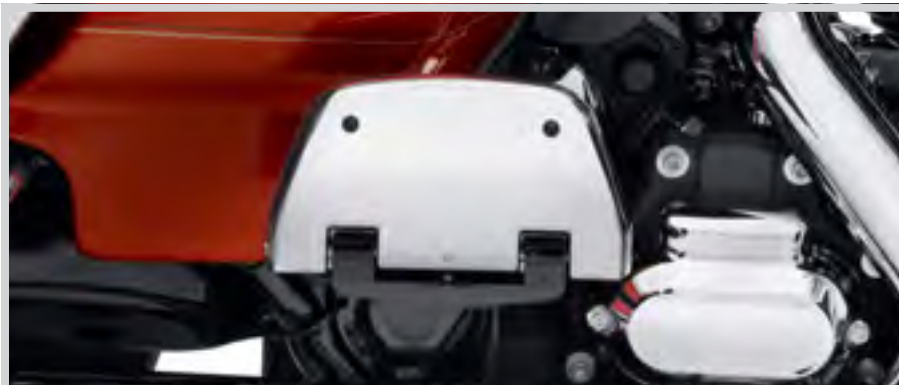

**F. PASSENGER FOOTBOARD PANS – CHROME**

**G. SWEEP WING PASSENGER FOOTBOARD PANS**

These unique Swept Wing Passenger Footboard pans complement the Swept Wing Rider Footboard shape and allow you to replace the Original Equipment passenger footpegs on certain models with footboards. When folded, the footboard displays a mirror-chrome surface in your choice of smooth or "ball-milled" grooved design. Footboard inserts and footboard supports sold separately.

Fits '86-later Touring, '00-later Softail and '06-later Dyna models equipped with passenger footboard supports. Does not fit Trike models.

<b>50357-04</b>	Chrome – Grooved.	<b>\$169.95</b>
<b>50716-04</b>	Chrome – Smooth.	<b>\$159.95</b>



**G. SWEEP WING PASSENGER FOOTBOARD PANS – CHROME GROOVED**



**G. SWEEP WING PASSENGER FOOTBOARD PANS – CHROME SMOOTH**

**H. HALF-MOON PASSENGER FOOTBOARD PANS AND INSERTS**

Styled to match the Half-Moon Rider Footboards, these classic passenger footboards add both style and comfort to your nostalgic ride. Available in mirror-finish chrome or gloss black finish, the kit includes left and right footboard pan and vibration-isolation footboard inserts. Model-specific footboard mounts are sold separately.

Fits '86-later Touring, '00-later Softail and '06-later Dyna models equipped with passenger footboard supports. Does not fit Trike models.

<b>50807-08</b>	Chrome.	<b>\$189.95</b>
<b>50810-08</b>	Gloss Black.	<b>\$179.95</b>



**H. HALF-MOON PASSENGER FOOTBOARD PANS – CHROME**



**H. HALF-MOON PASSENGER FOOTBOARD PANS – GLOSS BLACK**

*Notice: The prices appearing in this catalog are the manufacturer's suggested retail prices. Actual retail prices may vary.*

# 184 DYNA®

## Engine Guards

### A. ENGINE GUARD KIT\*

Protect your bike without sacrificing ground clearance or style. The one-piece Engine Guard is designed to complement the lines of the motorcycle and the available chrome or gloss black finish adds the perfect finishing touch.

For use with the mid or forward controls. Fits '06-later Dyna® models, '14-later FXDL and all '15-later Dyna models in India require separate purchase of Horn Relocation Bracket P/N 69000058. Fits with Oil Cooler Kit P/N 26151-07. FXDSE/2 and FXDFSE/2 requires removal of front chin spoiler and separate purchase of Regulator Caddy P/N 70464-08A. '06-'11 models equipped with evap canister also require separate purchase of Canister Bracket P/N 47207-06. '12-later models equipped with evap canister require separate purchase of Canister Relocation Kit P/N 60800005.

<b>49010-06</b>	Chrome.	<b>\$214.95</b>
<b>49320-09</b>	Gloss Black.	<b>\$214.95</b>

For use with mid-controls. Fits '91-'05 Dyna models (except '93-'05 FXDWG and '94-'05 FXDS-CONV. models). Not for use with Dyna Forward Control Kit P/N 49080-93 or Footboard Kit P/N 50580-01 and 50601-01. Will fit with Leather Tool Roll Kit P/N 91714-97A.

<b>49007-90A</b>	Chrome.	<b>\$214.95</b>
------------------	---------	-----------------

For use with forward controls. Fits '93-'05 FXDWG and FXDS-CONV. models. Also fits FXDX models. (Compatible with Forward Control Kit P/N 49080-93 only on FXDWG models.) Will not fit with Oil Cooler P/N 62871-00A, 26081-05 Dyna Fan Kit P/N 91551-00A or 91552-00A, Dyna Motor Mount Cover P/N 48426-98, Chrome Front Spoiler P/N 57081-01 or with Color-Matched Front Spoilers.

<b>49010-93</b>	Chrome.	<b>\$214.95</b>
-----------------	---------	-----------------

#### Also available:

#### EVAPORATIVE CANISTER RELOCATION KIT

**60800005** **\$29.95**  
Required when mounting Engine Guard P/N 49320-09 or 49010-06 on '12-later Dyna models designated for California and Asia-Pacific markets.

### B. SOFT LOWERS

Extend your riding season. Full coverage Soft Lowers provide wind and mud protection for the rider's legs and boots and minimize cold updrafts as the weather changes. Covers are custom shaped to hug the engine guard to minimize flapping and they simply clip in place for speedy installation as the weather changes. Two-way zippered outer edge accommodates guard-mounted highway pegs in almost any position. Reflective piping provides added visibility and convenient zippered pockets provide additional storage for maps or other small items.

**57100212** **\$89.95**  
Fits '06-later FXD, FXDB, FXDC and FXDL models equipped with Engine Guard P/N 49010-06 or 49320-09. Does not fit models with forward controls or footboards.



A. ENGINE GUARD KIT – CHROME (49010-06 SHOWN)



A. ENGINE GUARD KIT – GLOSS BLACK



B. SOFT LOWERS



B. SOFT LOWERS



**\*WARNING:** These guards may provide limited leg and cosmetic vehicle protection under unique circumstances (fall over while stopped, very low speed slide). They are not made nor intended to provide protection from bodily injury in a collision with another vehicle or any other object.

Notice: The prices appearing in this catalog are the manufacturer's suggested retail prices. Actual retail prices may vary.



# DYNA® 185

Engine Guards

NEW



C. MUSTACHE ENGINE GUARD – CHROME

### C. MUSTACHE ENGINE GUARD\*

Combine classic shape and modern function for a unique twist on engine protection. The flow of this engine guard complements the bike's traditional style while the gracefully curved upper section incorporates highway pegs into the shape. The integrated rubber pads offer a comfortable and slip-resistant cushion for your feet while traveling the open road. One-piece engine guard kit includes all required mounting hardware.

Fits '06-later Dyna® models. '14-later FXDL and all '15-later Dyna models in India require separate purchase of Horn Relocation Bracket P/N 69000058. Fits with Oil Cooler Kit P/N 26151-07. FXDSE/2 and FXDFSE/2 requires removal of front chin spoiler and separate purchase of Regulator Caddy P/N 70464-08A. '06-'11 models equipped with evap canister also require separate purchase of Canister Bracket P/N 47207-06. '12-later models equipped with evap canister require separate purchase of Canister Relocation Kit P/N 60800005.

<b>49000077</b>	Chrome.	<b>\$269.95</b>
<b>49000078</b>	Gloss Black.	<b>\$269.95</b>

Also available: (not shown)

### HORN BRACKET ADAPTER

Required when mounting Engine Guard P/N 49010-06, 49320-09, 49000077 or 49000078 on '14-later FXDL models and all '15-later Dyna models for India.

<b>69000058</b>		<b>\$9.95</b>
-----------------	--	---------------

Fits '14-later FXDL models and all '15-later Dyna models for India equipped with Engine Guard P/N 49010-06, 49320-09, 49000077 or 49000078.

NEW



C. MUSTACHE ENGINE GUARD – GLOSS BLACK

### D. SWITCHBACK™ REAR SADDLEBAG GUARDS – CHROME\*

Add protection and style to your ride. These chrome guards add a traditional Bagger look to the Dyna® Switchback™ model and protect the leading edge of the saddlebags. The innovative design allows the guards to be removed with the detachable saddlebags for a stripped-down look and the integrated stand keeps the bags upright and off the ground when off the bike. Kit includes left and right guards and all necessary mounting hardware.

<b>90201044</b>		<b>\$299.95</b>
-----------------	--	-----------------

Fits '12-later FLD models.

NEW



D. SWITCHBACK SADDLEBAG GUARDS – CHROME



**\*WARNING:** These guards may provide limited leg and cosmetic vehicle protection under unique circumstances (fall over while stopped, very low speed slide). They are not made nor intended to provide protection from bodily injury in a collision with another vehicle or any other object.

Notice: The prices appearing in this catalog are the manufacturer's suggested retail prices. Actual retail prices may vary.

DYNA

# 186 DYNA®

## Chassis Trim – Front End

### A. LOWER FORK SLIDERS – CHROME

Competitively priced, these chrome-plated Lower Fork Sliders give your bike up-front style. A perfect addition during the installation of Profile® Low Front suspension components. To ensure proper fitment and function, these sliders are manufactured from Original Equipment components. Form follows function, with polished, triple chrome-plating and a stamped "Harley-Davidson" logo for product identification. Kit includes right and left side sliders.

**45500267** **\$449.95**  
Fits '14-later FXDL models with dual disc brakes.

**45500064** **\$449.95**  
Fits '06-later Dyna® models (except FLD, FXDF, FXDWG, FXDFSE/2, FXDSE/2 and '14-later FXDL).

**45500065** **\$469.95**  
Fits '08-later FXDF models.

**45500066** **\$449.95**  
Fits '06-later FXDWG models.

**45500067** **\$449.95**  
Fits '12-later FLD models.

**46492-00** **\$429.95**  
Fits '00-'07 XL models (except XL883R, XL1200S and XL1200R) and '00-'03 FXD and '01-'03 FXDL models.

**45275-98** **\$429.95**  
Fits '88-'99 Sportster® models and FXD Super Glide®, '87-later FXLR and '88-'99 FXR and FXRS. (Does not fit Sportster Sport models.)

**46477-00** **\$449.95**  
Fits '00-'05 FXDWG, '00-'06 FXST and FXSTB models.

**45305-98** **\$449.95**  
Fits '91-'99 FXDWG, FXST, FXSTB and FXSTC models.

### B. LOWER FORK SLIDERS – GLOSS BLACK

These gloss black coated sliders are the ultimate extension of your bike's "dark side" and make a perfect custom addition to your blacked-out ride. Manufactured to Original Equipment specifications, the durable black coating is a great match to other H-D® black components. Add matching gloss black Billet Fork Slider Dust Covers P/N 45800014 for a complete look. Kit includes right and left sliders.

**45500273** **\$449.95**  
Fits '14-later FXDL models with dual disc brakes.

**45500073** **\$449.95**  
Fits '06-later FXDWG models.

**45500074** **\$449.95**  
Fits '06-later Dyna models (except FLD, FXDF, FXDWG, FXDFSE/2, FXDSE/2 and '14-later FXDL).

### C. FRONT END KIT – CHROME

The front forks on a Harley-Davidson® motorcycle set the tone for the bike and can lead the way to a full-bore custom statement. So start customizing by adding chrome where it counts. A perfect addition during the installation of Profile Low Front suspension components, the kit includes fork sliders, chrome dust caps, axle nut covers and upper fork nut covers. Chrome Front End Package price does not include labor or supplies.

**45800076** **\$549.95**  
Fits '14-later FXDL models with dual disc brakes.

### D. FRONT END KIT – GLOSS BLACK

Lead the way to the dark side. This complete blacked-out Front End Kit includes all the major components required to convert the Original Equipment satin-finished front end to a dark custom style. A perfect addition during the installation of Profile Low Front suspension components, the kit includes gloss black fork sliders, gloss black fork dust covers and gloss black front axle nut cover kit.

**45800075** **\$549.95**  
Fits '14-later FXDL models with dual disc brakes.

**45800010** **\$549.95**  
Fits '08-later FXDWG models. Includes gloss black upper fork nut covers.

**45800011** **\$549.95**  
Fits '08-later Dyna models (except FLD, FXDF, FXDFSE/2, FXDSE/2, FXDWG and '14-later FXDL).



**A. LOWER FORK SLIDERS – CHROME ('06 DYNA SHOWN)**



**A. LOWER FORK SLIDERS – CHROME**



**B. LOWER FORK SLIDERS – GLOSS BLACK (SHOWN WITH BILLET FORK SLIDER DUST COVERS)**



**B. LOWER FORK SLIDERS – GLOSS BLACK**



**C. FRONT END KIT – CHROME (45800076 SHOWN)**

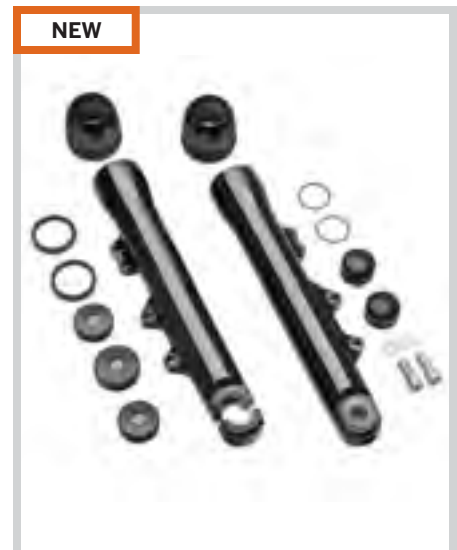

**D. FRONT END KIT – GLOSS BLACK (45800075 SHOWN)**

*Notice: The prices appearing in this catalog are the manufacturer's suggested retail prices. Actual retail prices may vary.*





**E. BILLET FORK SLIDER DUST COVERS – CHROME**



**E. BILLET FORK SLIDER DUST COVERS – GLOSS BLACK**

### E. BILLET FORK SLIDER DUST COVERS

Oversized billet covers are designed to replace the Original Equipment dust caps, creating a big, beefy look to the front forks. Available in your choice of mirror chrome or gloss black finish, these covers are the perfect addition to matching accessory fork sliders and upper fork nut covers.

Fits '06-later Dyna® models (except FLD and FXDSE/2). Does not fit with Screamin' Eagle® Chrome Fork Brace P/N 46634-06 or 46595-06A and Turn Signal Relocation Kit P/N 69433-08A.

<b>46889-06</b>	Chrome.	<b>\$69.95</b>
<b>45800014</b>	Gloss Black.	<b>\$69.95</b>

### F. DECORATIVE FORK JOINT COVERS – CHROME

Add a bigger, beefy look to the fork slider dust covers without disassembling the front fork. This polished and chrome-plated kit is easy to install without tools.

**45415-82**  
Fits '84-'99 FXSTC, '84-later FXST, FXSTB, '93-'05 FXDWG and '80-'86 FXWG models.

**\$64.95**

### G. LOWER FRONT FORK DUST COVERS – CHROME

Replace your stock black rubber fork slider seal with this beautiful, chrome billet 6061-T6 aluminum dust cover.

**45243-00**  
Fits '84-'99 FXSTC, '84-later FXST, FXSTB and '91-'05 FXDWG and '80-'86 FXWG models.

**\$64.95**

### H. FRONT AXLE NUT COVERS

Cover the front axle in style. Available in chrome or gloss black finish, custom Axle Nut Covers look great with Original Equipment satin-finish fork sliders or add the finishing touch to a complete chrome or blacked-out front end. These Axle Cover Kits are easy to install and include all necessary mounting hardware. Sold in pairs.

Fits '02-'11 VRSC™ (except VRSCF, VRSCR and '12-later VRSCDX), '15-later XG, '08-later XL, '08-later Dyna®, '07-later Softail® (except Springer™, FXCW, FXCWC, FLSTNSE, FXSBSE, FXST-Aus and FXSTD) and '08-later Touring and Trike models.

<b>44117-07A</b>	Chrome – Die-cast.	<b>\$27.95</b>
<b>43000026</b>	Gloss Black – Die-cast.	<b>\$27.95</b>
<b>44116-07A</b>	Chrome – Billet.	<b>\$42.95</b>
<b>43428-09</b>	Gloss Black – Billet.	<b>\$42.95</b>

Fits '00-'07 Touring models and '04-'07 Dyna models (except '04-'05 FXDWG and '07 FXDSE).

<b>43061-04</b>	Chrome – Billet.	<b>\$42.95</b>
<b>43062-04</b>	Chrome – Die-cast.	<b>\$27.95</b>

Fits '88-'07 XL, '91-'03 Dyna FXD, FXDX, FXDXT, FXDL, FXDS-CONV.; '93-'05 FXDWG, '84-'06 Softail (except Springer and FXSTD), '80-'99 Touring models. Also fits '88-'07 FXR and '87-later FLXR/FXRS-SP, FXWG models.

<b>43899-86A</b>	Chrome – Die-cast.	<b>\$27.95</b>
------------------	--------------------	----------------



**F. DECORATIVE FORK JOINT COVERS – CHROME**



**G. LOWER FRONT FORK DUST COVERS – CHROME**



**H. FRONT AXLE NUT COVERS – CHROME**



**H. FRONT AXLE NUT COVERS – GLOSS BLACK**

# 188 DYNA®

## Chassis Trim – Front End

### A. BURST FRONT AXLE NUT COVERS

Finish your blacked-out forks in style. Rich black and prismatic machined surfaces provide the contrast and the race-track ridges and the inner spider design make a powerful visual statement. Easy to install kit includes mounting hardware.

**43000031 \$69.95**

Fits '02-'11 VRSC™ (except VRSCF, VRSCR and '12-later VRSCDX), '15-later XG, '08-later XL, '08-later Dyna®, '07-later Softail® (except Springer™, FXCW, FXCWC, FXSB, FXSBSE, FXSTD and FLSTNSE) and '08-later Touring and Trike models.

### B. LOW-PROFILE FRONT AXLE NUT COVERS

Thanks to the tapered design, these die-cast Low-Profile Axle Covers appear smaller than a traditional axle cover. The brilliant chrome finish looks great with Original Equipment polished or accessory chrome fork sliders and the hidden fasteners keep the look clean.

**47646-09 \$46.95**

Fits '06-'11 VRSC (except VRSCF, VRSCR and '12-later VRSCDX) and '08-later Dyna models (except FXDSE).

### C. "H-D MOTOR CO." LOGO FRONT AXLE NUT COVERS

Die-cast, chrome-plated covers feature the "Harley-Davidson Motor Co." logo in black. Includes Allen®-head set screws and wrench for easy installation.

**44148-07A \$29.95**

Fits '02-'11 VRSC (except VRSCF, VRSCR and '12-later VRSCDX), '15-later XG, '08-later XL, '08-later Dyna, '07-later Softail (except Springer, FXCW, FXCWC, FXSB, FXSBSE, FXST-Aus FXSTD and FLSTNSE) and '08-later Touring and Trike models.

**43063-04 \$27.95**

Fits '00-'07 Touring models and '04-'07 Dyna models (except '04-'05 FXDWG and '07 FXDSE).

### D. WILLIE G SKULL FRONT AXLE NUT COVERS

Add a little attitude to your ride. The Axle Nut Covers are easy to install and include all necessary mounting hardware. Sold in pairs.

**43163-08A \$34.95**

Fits '02-'11 VRSC (except VRSCF, VRSCR and '12-later VRSCDX), '15-later XG, '08-later XL, '91-later Dyna, '84-later Softail (except Springer, FXCW, FXCWC, FXSB, FXSBSE, FXSTD and FLSTNSE) and '99-later Touring and Trike models.

### E. TAPERED FRONT AXLE NUT COVERS

Thanks to an exclusive contoured profile, these unique chrome die-cast Front Axle Nut Covers appear smaller than others when installed. Sold in pairs.

**44109-07 \$27.95**

Fits '02-'11 VRSC (except VRSCF, VRSCR and '12-later VRSCDX), '08-later Dyna, '07-later Softail (except Springer, FXCW, FXCWC, FXSB, FXSBSE, FXSTD and FLSTNSE) and '08-later Touring models.

**43051-01 \$27.95**

Fits '00-'07 Touring models and '04-'07 Dyna models (except '04-'05 FXDWG and '07 FXDSE).

### F. ALUMINATOR® FRONT AXLE NUT COVERS

Chrome-plated billet aluminum axle covers feature a classic Bar & Shield logo insert. Includes all necessary mounting hardware for easy installation.

**44114-07 \$42.95**

Fits '02-'11 VRSC models (except VRSCF, VRSCR and '12-later VRSCDX), '08-later Dyna, '07-later Softail models (except Springer, FXCW, FXCWC, FXSB, FXSBSE, FXSTD and FLSTNSE) and '08-later Touring models.

**43059-04 \$42.95**

Fits '00-'07 Touring models and '04-'07 Dyna models (except '04-'05 FXDWG and '07 FXDSE).

**43907-94 \$42.95**

Fits '88-'07 XL, '91-'03 Dyna FXD, FXDX, FXDXT, FXDL, FXDS-CONV.; '93-'05 FXDWG, '84-'06 Softail (except Springer and FXSTD), '80-'99 Touring models. Also fits '88-'07 FXR and '87-later FLXR/FXRS-SP, FXWG models.



A. BURST FRONT AXLE NUT COVERS



B. LOW-PROFILE FRONT AXLE NUT COVERS



C. "H-D MOTOR CO." LOGO FRONT AXLE NUT COVERS



D. WILLIE G SKULL FRONT AXLE NUT COVERS



E. TAPERED FRONT AXLE NUT COVERS



F. ALUMINATOR FRONT AXLE NUT COVERS

*Notice: The prices appearing in this catalog are the manufacturer's suggested retail prices. Actual retail prices may vary.*





**G. FORK AXLE RETAINER NUT KIT – CHROME**  
(DYNA/XL SHOWN)



**G. FORK AXLE RETAINER NUT KIT – CHROME**  
(FXDWG SHOWN)

**G. FORK AXLE RETAINER NUT KIT – CHROME**

It's the details that count. Complete the chrome transformation by adding this finishing touch to your chrome fork sliders. This Fork Axle Retainer Nut Kit includes the stylish chrome-plated nuts and chrome lockwashers necessary to replace the stock hardware.

**45802-03 \$8.95**

Fits '88-later XL models, '93-'05 Dyna® FXD, FXDL, FXDS-CONV., FXDX, FXDX-T models and '88-'94 FXR, FXRS, FXRS-SP, FXRS-CONV., FXLR and FXRT models.

**45813-03 \$8.95**

Fits '84-later Touring and Trike models, '86-'07 FLST, FLSTC, FLSTF, FLSTN, '91-'07 FXST and FXSTB, '07 FXSTC and '91-'05 FXDWG models.

**Also available:**

**FORK SLIDER DRAIN SCREW KIT – CHROME**

This Fork Slider Drain Screw Kit includes two chrome-plated drain screws and the seals required to replace the stock hardware.

**45848-03 \$3.95**

Fits '87-later Softail® (except Springer™, FXCW, FXCWC, FXSB, FXSBSE and FXSTD), '87-'13 Touring models and '93-'05 FXDWG models.

**45815-03 \$3.95**

Fits '73-'13 XL models (except XL Sport, XL883L, XL1200X and '11-later XL1200C), '78-'86 FX models, '94-'05 Dyna FXD/DL/DS-CONV., '99-'00 FXR2/3/4 models and '00-'07 FXSTD models.

**H. FRONT WHEEL SPACERS – CHROME**

Complete your total front end with these highly polished chrome-plated wheel spacers. Manufactured to the Original Equipment tolerances, they deliver exact fitment and custom shine.

**41597-00 Straight. \$29.95**

Fits '00-'06 FXST, FXSTB, FXSTD and '00-'05 FXDWG models. Also fits models equipped with Inverted Front Fork Kit and .75" Axle Kit P/N 42134-06 or Billet Fork Sliders P/N 46280-03. Does not fit '03-'04 FXSTDSE.

**41616-02 Straight. \$29.95**

Fits '00-'07 XL models and '00-'03 FXD, FXDL, FXDX, FXDXT and FXDS-CONV. models.

**41420-08 Tapered. \$34.95**

Fits '08-later Dyna models without ABS (except FLD, FXDWG, FXDF and FXDFSE/2). Does not fit with Typhoon Custom Wheel P/N 44615-08, 44657-08, 40774-10 or 43300053, Magnum 5 Custom Wheel P/N 43621-09, 40516-10 or 43300049 or Road Winder™ Custom Wheel P/N 44689-08.

**41361-08 Tapered. \$34.95**

Fits '08-later FLD, FXDF and FXDWG models without ABS.

**I. SCREAMIN' EAGLE® FORK BRACE – CHROME**

These chrome Fork Braces are machined from billet aluminum, then polished and chrome-plated to complement the curve of the front fender. The machined Screamin' Eagle® logo finishes the look with crisp detail. Easy to install, these braces offer increased torsional rigidity.

**46595-06A \$219.95**

Fits '06-later FXD, FXDB, FXDC, FXDL and '02-'08 VRSCA, VRSCB, VRSCD and VRSCX models.

**46192-99A \$219.95**

Fits '87-later XL (except XL883N, XL883L, XL1200N, XL1200T, XL1200X, '11-later XL1200C), '91-'05 Dyna (except FXDWG) and FXR models (except FXRT) with 39mm front forks. (Will not fit with Chrome Fork Sliders.)

**J. CUSTOM FORK BRACE**

This chrome-plated Fork Brace adds style to the front end. The cross-brace open web style reflects a performance heritage and the multi-piece design allows easy installation.

**46097-98 41mm. \$159.95**

Fits '93-'05 FXDWG and '84-later FX Softail models (except Springer, FXCW, FXCWC, FXS, FXSB, FXSBSE and FXSTD). (Will not fit with Chrome Lower Fork Sliders.)



**H. FRONT WHEEL SPACERS – CHROME, STRAIGHT**



**H. FRONT WHEEL SPACERS – CHROME, TAPERED**



**I. SCREAMIN' EAGLE FORK BRACE – CHROME**



**J. CUSTOM FORK BRACE**

DYNA

*Notice: The prices appearing in this catalog are the manufacturer's suggested retail prices. Actual retail prices may vary.*

# 190 DYNA®

## Chassis Trim – Brakes

### A. BRAKE CALIPER KIT – RED

Dress your bike in the latest high-performance look. Brilliant red calipers make a powerful visual statement and set your bike apart from the ordinary. Manufactured from Original Equipment components for proven performance, these calipers will add a stylish touch to the stock bike or add the perfect finish to a complete custom equipped with chrome or blacked-out wheels, rotors and fork sliders.

**41300127** Front & Rear Kit. **\$399.95**  
Fits '08-later Dyna® and '08-'14 Softail® models (except Springer™) equipped with single disc front brakes. Kit includes one front and one rear caliper. Brake pads sold separately.

**41300126** Front – Single Disc. **\$249.95**  
Fits '00-'03 XL, '00-'07 Dyna and '00-'07 Softail models with single disc front brakes. Brake pads sold separately.

**41300120** Front – Dual Disc. **\$399.95**  
Fits '02-'05 VRSC™, '00-'03 XL, '00-'07 Dyna and '00-'07 Touring models with dual disc front brakes. Brake pads sold separately.

### B. BRAKE CALIPER KIT – CHROME

Add the shine of chrome to your bike with this highly polished Chrome Brake Caliper Kit. Manufactured from Original Equipment components for proven performance, these calipers add the finishing touch to a complete custom with chrome wheels, rotors and chrome fork sliders. (Brake pads and pad pins not included.)

**44395-08** Front – Single Disc. **\$389.95**  
Fits '08-later Dyna (except '14-later FXDL) and '08-'14 Softail models (except Springer) equipped with single disc front brakes.

**44395-00A** Front – Single Disc. **\$389.95**  
Fits '00-'03 XL and '00-'07 Dyna and Softail (except Springer) models equipped with single disc front brakes.

**44392-00A** Front – Dual Disc. **\$799.95**  
Fits '00-'03 XL, '02-'05 VRSC and '00-'07 Dyna, Softail and Touring models equipped with dual disc front brakes.

**42047-08** Rear. **\$349.95**  
Fits '08-later Dyna and Softail models.

**42035-06** Rear. **\$449.95**  
Fits '06-'07 Dyna models.

### C. REAR BRAKE CALIPER BRACKET – CHROME

Manufactured from the Original Equipment components for exact fit, this mount will bolt to the existing mounting location.

**42002-08** Fits '08-later Dyna models. **\$119.95**



A. BRAKE CALIPER KIT – RED  
(41300127 SHOWN)



A. BRAKE CALIPER KIT – RED  
(41300126 SHOWN)



A. BRAKE CALIPER KIT – RED  
(41300120 SHOWN)



B. FRONT BRAKE CALIPER KIT – CHROME  
(SHOWN WITH CHROME CALIPER BOLT COVER  
KIT AND CALIPER INSERT)



B. FRONT BRAKE CALIPER KIT – CHROME



B. REAR BRAKE CALIPER KIT – CHROME  
(SHOWN WITH CHROME BRACKET)



C. REAR CALIPER BRACKET – CHROME





**D. FRONT CALIPER COVER – CHROME (SHOWN WITH CHROME CALIPER BOLT COVER KIT)**



**D. REAR CALIPER COVER – CHROME**



**E. CUSTOM CALIPER BOLT COVER KIT**



**F. BRAKE CALIPER INSERT – DEEP DISH**



**F. BRAKE CALIPER INSERT – CLASSIC CHROME**



**F. BRAKE CALIPER INSERTS**



**G. BRAKE CALIPER TRIM DISCS**

### D. CALIPER COVER – CHROME

Chrome-plated caliper cover styled with stepped contours and textured recess for a distinctive look. Does not require brake line removal.

**43759-00** Front. **\$42.95**

Fits left-hand calipers on '00-'07 FXDWG and '00-'07 Softail® models (except Springer™ and FXSTD models). Will not fit with braided brake lines.

**43553-00** Rear. **\$38.95**

Fits '00-'05 Dyna® and '00-'07 Softail models (except '06-'07 FXST, FXSTB, FXSTS and FLSTFSE2). Will not fit with braided brake lines.

### E. CUSTOM CALIPER BOLT COVER KIT

Cover your 12-point caliper bolts in chrome. These easy-to-install chrome covers are held firmly in place with a steel spring clip and are styled to match the Chrome Rocker Box Bolt and Headbolt Covers.

**43824-03** Four Large Covers. **\$23.95**

Fits '00-later front and rear 12-point caliper mounting bolts (except Springer front calipers, '15-later XG, '08-later Touring, '08-later Trike and '06 VRSCR models).

**40955-05** Four Large and Two Small Covers. **\$28.95**

Fits '00-later front brake calipers (except Springer models, '15-later XG, '04-later XL, '08-later Touring, '06-later VRSC models and models equipped with caliper covers). Also fits rear calipers on '06-later Softail models (except FXCW).

**40959-05** Three Large and Two Small Covers. **\$23.95**

Fits '00-later rear brake calipers (except '15-later XG, '04-later XL, '08-later Touring, '06-later FXST, FXSTB, FXSTS, FLSTSB, '06-later VRSC models and models equipped with caliper covers).

### F. BRAKE CALIPER INSERTS

Easy-to-install inserts add a finishing touch to the front and rear brake calipers. Select a style that follows your custom direction. Self-adhesive backing.

Fits '00-later front and rear brake calipers on all models (except Springer front, '08-later Touring, '08-later Trike, '04-later XL, '15-later XG and '06-later VRSC models).

**1. 44542-03** Deep Dish. **\$16.95**

**2. 44477-99** Classic Chrome. **\$16.95**

**3. 44476-99** "Harley-Davidson" Script. **\$16.95**

**4. 44474-99** Flames. **\$16.95**

### G. BRAKE CALIPER TRIM DISCS

Available in 1.375" and 1.75" diameters to accommodate front and rear calipers on most '99-earlier models and front calipers on '00-later Springer models. Easy to install.

**1. 44095-96** "H-D Motor Co." – 1.375" Diameter. **\$16.95**

**44093-96** "H-D Motor Co." – 1.75" Diameter. **\$16.95**

**2. 99661-92T** Gold Live to Ride – 1.375" Diameter. **\$16.95**

**99663-92T** Gold Live to Ride – 1.75" Diameter. **\$16.95**

**3. 99679-98** Flames – 1.375" Diameter. **\$11.95**

# 192 DYNA®

## Chassis Trim – Front End

### A. UPPER FORK NUT COVERS

Highlighted with a unique Bar & Shield logo, these easy-to-install billet-look covers hide the Original Equipment fork and steering stem hex-head hardware and add a clean custom touch to the top of the triple tree. Available in your choice of chrome or gloss black finish, the kit comes complete with three covers and mounting hardware.

**45800015** Gloss Black. **\$59.95**  
Fits '06-later Dyna® models (except FLD, FXDB and FXDSE/2).

**46109-06** Chrome. **\$59.95**  
Fits '06-later Dyna models (except FLD, FXDB and FXDSE/2).

**46129-98B** Chrome. **\$59.95**  
Fits '86-later FLSTC, '90-later FLS, FLSTF, '95-'05 FXD, '93-'05 FXDL, '94-'05 FXDS-CONV. and '88-'13 XL models (except XL Custom and XL1200S models.).

**45002-98** Chrome. **\$59.95**  
Fits '00-later FXST, FXSTB, FXSTD, '86-later FXSTC and '93-'05 FXDWG models.



A. UPPER FORK NUT COVERS – GLOSS BLACK

### B. TRIPLE TREE KIT – GLOSS BLACK

The classic Harley-Davidson color is black. It shows your attitude, your feelings and your desire to be different from the rest. This gloss black Triple Tree is the ultimate extension of the Harley-Davidson philosophy. Manufactured from Original Equipment components to ensure superior fit and finish, this gloss black Triple Tree complements the black fork sliders and the handlebar risers featured on the Dyna® Fat Bob® model. Add the matching Black Handlebar P/N 55977-09 for a complete blacked-out look.

**48609-09** **\$279.95**  
Fits '08-later FXDF and FXDFSE/2 models.



A. UPPER FORK NUT COVERS – CHROME



B. TRIPLE TREE KIT – GLOSS BLACK

*Notice: The prices appearing in this catalog are the manufacturer's suggested retail prices. Actual retail prices may vary.*





**C. TRIPLE TREE KIT – CHROME**



**D. CLASSIC CHROME STEERING STEM BOLT COVER KIT**

**C. TRIPLE TREE KIT – CHROME**

Drape your front end in chrome. The ideal complement to chrome fork sliders, this beautifully polished and plated Triple Tree is manufactured from Original Equipment components to ensure quality and fit. The kit includes chrome hardware and fork stem installed in lower tree.

**45023-02** **\$279.95**  
Fits '90-'05 FXD, FXDL, FXDS-CONV. and FXDX models.  
Requires separate purchase of Bearing P/N 48300-60.

**D. CLASSIC CHROME STEERING STEM BOLT COVER KIT**

For a finished appearance of the upper fork clamp on all models with 39mm forks.

**48329-90A** **\$39.95**  
Fits XL, '91-'05 Dyna® and FXR models with 39mm forks.  
(Does not fit FXDWG.)

**E. FRONT FENDER TRIM**

Add a sweeping dash of chrome to the front fender. Chrome-plated tapered spear features a stepped design that accentuates the flowing fender lines. Self-adhesive backing simplifies installation.

**14100618** **\$44.95**  
Fits Dyna FLD, FL Softail® and Touring and Trike models with full front fender.

**F. BAR & SHIELD LOGO FRONT FENDER SPEAR**

This chrome-plated trim spear adds a sweeping dash of chrome to the front fender. Featuring a raised Bar & Shield logo set against a textured black field, this self-adhesive medallion is easy to install.

**91194-04** Small **\$39.95**  
Fits XL, XR, Dyna (except FLD) and FX Softail models.

**G. FRONT FENDER EXTENSION – CHROME**

Dress your front fender in chrome. This chrome-plated tapered Fender Extension is shaped to follow the curve of the fender for style and function. Using the Original Equipment fender hole, the extension mounts below the trailing edge of the fender to help control road dirt and spray.

**59664-03** **\$49.95**  
Fits '91-'08 Dyna and '84-'07 FX Softail models. Will not fit FXD, FXDX or FXDXT models equipped with Voltage Regulator Covers.

**H. FRONT FENDER HARDWARE KIT – CHROME**

Finish the show-winning look with brilliant chrome hardware. Manufactured to Original Equipment specifications, this kit replaces the zinc-plated exposed front fender mounting bolts with chrome-plated socket head cap screws.

**94415-05** **\$9.95**  
Fits '91-later Softail models (except Springer™, FXCW, FXCWC, FXSB, FXSBSE and FXSTD) and '93-'05 FXDWG models. Does not fit with Billet Fork Sliders or Inverted Front End Kit.



**E. FRONT FENDER TRIM**



**F. BAR & SHIELD LOGO FRONT FENDER SPEAR**

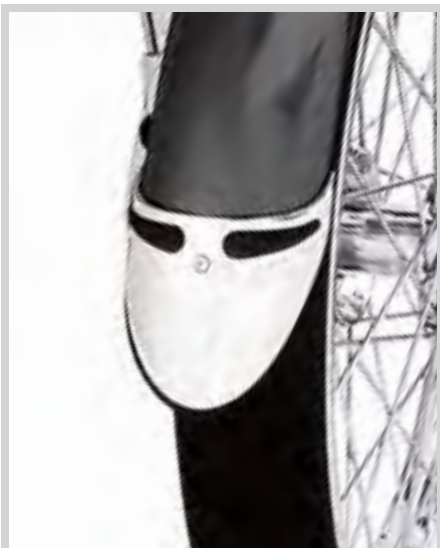

**G. FRONT FENDER EXTENSION – CHROME**



**H. FRONT FENDER HARDWARE KIT – CHROME**

*Notice: The prices appearing in this catalog are the manufacturer's suggested retail prices. Actual retail prices may vary.*

# 194 DYNA®

Chassis Trim – Rear End

## A. SWINGARM – CHROME

The ultimate chrome accessory, polished to the highest standard using bright plating to complement Original Equipment finishes. Affordable and convenient, with no troublesome exchanges necessary. Factory specifications guarantee exact fitment, unparalleled quality and an affordable price. Stamped with the Harley-Davidson logo.

**48458-10** Fits '10-later Dyna® models. **\$369.95**

**48458-06** Fits '06-'09 Dyna models. **\$399.95**

## B. REAR WHEEL SPACER KIT – CHROME

Add some chrome detail to an often overlooked area of the bike with this highly polished Chrome Wheel Spacer Kit. Manufactured to the Original Equipment tolerances, to ensure product fitment and quality.

**41362-08** Tapered. **\$34.95**

Fits '08-later Dyna models without ABS.

## C. EXHAUST MOUNTING BRACKET – CHROME

Replace the stock black bracket with this brilliantly chrome-plated piece. Manufactured from Original Equipment components for precise fit, this Exhaust Bracket complements both chrome and jet black exhaust systems.

**80871-10** **\$69.95**

Fits '08-later FXDF and '10-later FXDWG models.



**A. SWINGARM – CHROME**  
**(SHOWN WITH CHROME UPPER AND LOWER BELT GUARDS)**



**A. SWINGARM – CHROME**



**B. REAR WHEEL SPACER KIT – CHROME**



**C. EXHAUST MOUNTING BRACKET – CHROME**

*Notice: The prices appearing in this catalog are the manufacturer's suggested retail prices. Actual retail prices may vary.*



# DYNA® 195

Chassis Trim – Rear End



**D. CHROME UPPER AND LOWER BELT GUARDS – ('07-LATER STYLE SHOWN)**



**D. CHROME UPPER AND LOWER BELT GUARDS – ('00-'05 STYLE SHOWN)**



**E. SLOTTED UPPER BELT GUARD – CHROME**

## D. UPPER BELT GUARD – CHROME

Hand-polished and chrome-plated to replace your factory-equipped black upper belt guard.

**60303-07** Fits '07-later Dyna® models (except FXDF and FXDFSE/2). **\$109.95**

**60303-06** Fits '06 Dyna models. **\$109.95**

**60293-00** Fits '00-'05 Dyna models. **\$159.95**

Shown with:

## LOWER BELT GUARD COVER – CHROME

Designed to cover the Original Equipment black lower debris deflector, this mirror-chrome finished cover adds an exceptional finish to the rear drive components. Kit includes required mounting hardware.

**60514-07A** Fits '07-later Dyna models. **\$64.95**

**60489-06A** Fits '06 Dyna models. **\$64.95**

**60475-92A** Fits '91-'05 Dyna models and all '94-'99 International Dyna models equipped with 70- or 65-tooth sprockets. **\$64.95**

## E. SLOTTED UPPER BELT GUARD – CHROME

Designed to add a unique and stylish look, the hand-polished and chrome-plated Slotted Belt Guard opens up the left side of the bike for an aggressive profile. Easy to install, the Slotted Guard replaces the stock painted unit and includes chrome-plated mounting hardware.

**60711-07** Fits '07-later Dyna models (except FXDF and FXDFSE/2). **\$109.95**

Stock on '07-'08 FXDSE models.

DYNA

*Notice: The prices appearing in this catalog are the manufacturer's suggested retail prices. Actual retail prices may vary.*

# 196 DYNA®

## Chassis Trim – Rear End

### A. LOW-PROFILE REAR AXLE COVERS

This Low-Profile Rear Axle Cover is contoured to accent the tail end of the swingarm. Designed to conceal both the rear axle nut and the adjusting hardware, the smooth chrome surface and sleek hidden fasteners complement either an Original Equipment black or accessory chrome swingarm. This easy-to-install kit includes all required installation hardware.

**47645-09 \$134.95**  
Fits '08-later Dyna® models. Original Equipment on '10 FXDFSE models. Will not fit models equipped with saddlebags.



A. LOW-PROFILE REAR AXLE COVERS



B. "HARLEY-DAVIDSON" SCRIPT REAR AXLE COVERS

### B. "HARLEY-DAVIDSON" SCRIPT REAR AXLE COVERS

Chrome-plated die-cast cover conceals the side of the swingarm and the axle. Unique styling features a black-filled embossed "Harley-Davidson" script for a distinctive contrast. The kit is easy to install without removing the rear wheel. Kit includes all necessary mounting hardware.

**44346-06 \$74.95**  
Fits '06-later Dyna models. Will not fit models equipped with saddlebags.

### C. REAR AXLE NUT COVERS

Cover your rear axle nut in the most traditional way. These Rear Axle Cover Kits complement the matching Front Axle Nut covers. Easy to install, these cover kits include necessary mounting hardware. Sold in pairs.

#### Classic Chrome – Billet

**43132-08 \$42.95**  
Fits '08-later Dyna and Softail® models (except FXCW, FXCWC, FXSB, FXSBSE and FXST-Aus).

#### Classic Chrome – Die-cast

**41705-09 \$27.95**  
Fits '08-later Dyna and Softail models (except FXCW, FXCWC, FXSB, FXSBSE and FXST-Aus).

**42034-07 \$27.95**  
Fits '06-'07 Dyna models.

**44262-01 \$27.95**  
Fits '91-'05 Dyna models.



C. REAR AXLE NUT COVERS – CLASSIC CHROME



C. REAR AXLE NUT COVERS – GLOSS BLACK

#### Gloss Black

**43422-09 \$42.95**  
Fits '08-later Dyna and Softail models (except FXCW, FXCWC, FXSB, FXSBSE and FXST-Aus).

#### Willie G Skull Collection

**41706-09 \$34.95**  
Fits '08-later Dyna and Softail models (except FXCW, FXCWC, FXSB, FXSBSE and FXST-Aus).

**42064-07 \$29.95**  
Fits '06-'07 Dyna models.

#### "H-D Motor Co." Logo

**41704-09 \$29.95**  
Fits '08-later Dyna and Softail models (except FXCW, FXCWC, FXSB, FXSBSE and FXST-Aus).

**42065-07 \$29.95**  
Fits '06-'07 Dyna models.

**44257-01 \$29.95**  
Fits '91-'05 Dyna models.



C. REAR AXLE NUT COVERS – WILLIE G SKULL COLLECTION



C. REAR AXLE NUT COVERS – "H-D MOTOR CO." LOGO

### D. SHOCK BOLT COVERS

It's the details that complete the look of your bike. These Shock Bolt Covers are designed to hide the upper shock mounting hardware and provide a custom look to the rear of your bike. Easy-to-install, the kit includes left and right bolt covers and all required mounting hardware.

Fits '04-later XL and '06-later Dyna models (except FLD, FXDF and FXDL). Does not fit with H-D® Detachables™ Leather Saddlebag Kit P/N 90181-08A.

**54000016 Chrome. \$39.95**

**54000017 Gloss Black. \$39.95**



D. SHOCK BOLT COVERS – CHROME



D. SHOCK BOLT COVERS – GLOSS BLACK

*Notice: The prices appearing in this catalog are the manufacturer's suggested retail prices. Actual retail prices may vary.*



# DYNA® 197

## Chassis Trim – Rear End



**E. REAR FENDER SUPPORT COVER KIT – GLOSS BLACK**

### E. REAR FENDER SUPPORT COVER KIT – GLOSS BLACK

Manufactured from Original Equipment components to ensure superior fit and finish, the gloss black Fender Strut Covers conceal the cast fender struts and continue the dark look to the back of the bike. The ideal finishing touch for your "blacked-out" Fat Bob®, these covers are the perfect complement to available gloss black Passenger Sissy Bars and Luggage Racks.

**59473-09** **\$129.95**  
Fits '08-later FXDF and FXDFSE/2 models.

### F. SIDE-MOUNT LICENSE PLATE KIT

Add a clean, custom look to the rear fender. This stylish kit moves the license plate from the fender to a side-mount location, visually lowering the bike's profile and opening up the view of the rear end. This strut-mounted hinged frame conceals the license mounting hardware and features a smooth back that hides the unfinished side of the plate. Kit includes LED license plate illumination and a curved Bar & Shield medallion, shaped to conceal the original license mounting holes in the fender. Purchase of tail lamp without license illumination window is recommended for models with center-mounted tail lights.

NOTE: License plate location and fold-away feature is regulated in many states. Check state and local laws before installation.

Fits '06-later Dyna® models (except FLD, FXDF, FXDWG and FXDFSE/2). Will not fit models equipped with rigid mount saddlebags, rigid mount sissy bars and Turn Signal Relocation Kit P/N 68732-02A and 68733-02A.

<b>60938-10</b>	Chrome.	<b>\$199.95</b>
<b>60978-10</b>	Gloss Black.	<b>\$199.95</b>

### G. BOBTAIL REAR FENDER KIT\*

Change the look and the attitude of your Dyna motorcycle with a Bobtail Rear Fender. Standard on the Dyna Wide Glide® model. This sleek upturned fender adds style to the rear of your bike.

Fits '06-later FXD, FXDC, FXDL, '14-later FXDF and '06-'08 FXDB models. FXDF requires separate purchase of tail light assembly. Stock on '06-'08 FXDWG models. Does not fit '08-'13 FXDF, FXDFSE/2, '10-later FLD and FXDWG models. Requires separate purchase of Installation Kit P/N 69710-06.

<b>59925-06</b>	Primed.	<b>\$299.95</b>
<b>59925-06DH</b>	Vivid Black.	<b>\$399.95</b>

**Also available:**

### BOBTAIL REAR FENDER INSTALLATION KIT

Required for installation of Bobtail Fender Kit on Dyna models.

**69710-06** **\$249.95**  
Fits '06-later FXD, FXDC, FXDL, '14-later FXDF and '06-'08 FXDB models. Stock on '06-'08 FXDWG models.



**F. SIDE-MOUNT LICENSE PLATE KIT – CHROME**



**F. SIDE-MOUNT LICENSE PLATE KIT – GLOSS BLACK**



**G. BOBTAIL REAR FENDER KIT – VIVID BLACK**

*Notice: The prices appearing in this catalog are the manufacturer's suggested retail prices. Actual retail prices may vary.*

# 198 DYNA®

Chassis Trim – Brakes

## A. BRAKE BLEEDER AND BANJO BOLT COVERS

### 1. Brake Bleeder Screw Cover

This cover adds chrome to the unfinished bleeder valve on stock H-D® calipers. Package of two.

**43834-98** **\$23.95**

Fits '84-later stock calipers (except XR models).

### 2. Chrome Banjo Bolt Cover

Die-cast chrome cover provides a custom look to your stock banjo bolts. Fits banjo bolts on front and rear brake master cylinders and front and rear calipers. Installs in seconds.

**32715-98** **\$21.95**

Fits '84-later models with stock master cylinders and calipers. (Does not fit VRSC™ Rear Master Cylinder, '06-later VRSC calipers, '08-later Touring or '04-later XL models.)



A. BRAKE BLEEDER AND BANJO BOLT COVERS

## B. BANJO BOLT KIT – CHROME

Replace the Original Equipment 12-point zinc finish brake line hardware with brilliant chrome custom tapered banjo bolts.

**41842-06** **\$29.95**

Fits '91-'03 XL, '91-later Dyna® (except FXDF), '95-'14 Softail® and '99-'00 FXR models equipped with single front brake. Does not fit on the Dyna or Softail ABS Hydraulic Control Unit. Does not fit with Banjo Bolt Cover P/N 32715-98. Kit includes one .4375" banjo bolt, three .375" banjo bolts and eight sealing washers.

## C. WIDE TIRE KIT – DYNA MODELS

Add the wide tire look to your '06-later Dyna model. The 180mm rear tire fills out the rear fender to add a menacing look from the back. A simple conversion at your first tire change, the kit includes the DUNLOP® GT502 180/60B17 rear tire and the required installation brackets and hardware. This easy-to-install kit fits with the Original Equipment 17.0" wheel and requires no frame or powertrain alterations.

**43779-09** **\$399.95**

Fits '09-'12 FXDB models. Use with '10-'12 FXDB requires separate purchase of DUNLOP front tire. Use with saddlebag kits requires separate purchase of two Fender Mounting Brackets P/N 60181-09 (not required when used with Docking Hardware Kit P/N 53797-09).

**43705-06** Fits '06-'08 FXDWG models. **\$399.95**

**43768-06** **\$399.95**

Fits '06-later Dyna models (except FLD, FXDWG, FXDF, FXDSE/2, FXDFSE/2 and '09-later FXDB). '10-later Dyna models require separate purchase of DUNLOP front tire. Installation of Rigid Sideplate Kit P/N 52856-06 on models without saddlebags requires separate purchase of Hardware Kit P/N 53975-06. Installation of H-D® Detachables™ Sideplate Kit P/N 52866-06 on models without saddlebags requires separate purchase of Hardware Kit P/N 53974-06.



B. BANJO BOLT KIT – CHROME

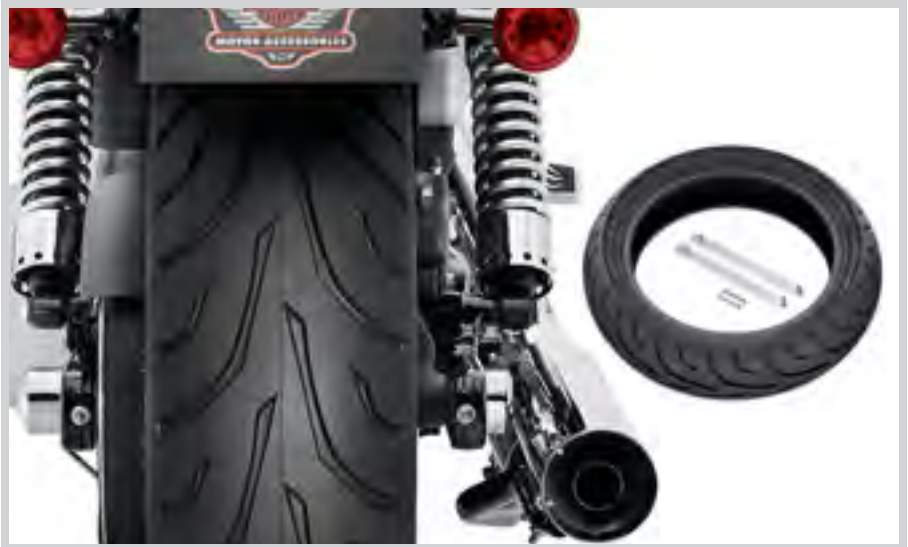

C. WIDE TIRE KIT – DYNA MODELS (STREET BOB SHOWN)

Notice: The prices appearing in this catalog are the manufacturer's suggested retail prices. Actual retail prices may vary.





**D. SPROCKET COVER – CHROME**



**D. SPROCKET COVER – CHROME**

**D. SPROCKET COVER – CHROME**

This sprocket cover gives the appearance of a chrome sprocket at a fraction of the cost. It matches the styling of the Original Equipment sprocket and bolts on using the Original Equipment hardware.

**37756-07** **\$49.95**  
Fits '07-later Dyna® models (except FLD).

**E. TYPHOON SPROCKET COVER**

Styled to match the distinctive Typhoon Custom Wheel. Available in mirror-chrome or gloss black, this Sprocket Cover gives the appearance of having a custom sprocket at a fraction of the cost. Cover easily bolts on using the stock hardware or for a finished look, add the Chrome Hardware Kit P/N 94773-07 (sold separately).

Fits '07-later Dyna models.  
**40142-08** Chrome. **\$49.95**  
**42200012** Gloss Black. **\$49.95**



**E. TYPHOON SPROCKET COVER – CHROME**



**E. TYPHOON SPROCKET COVER – GLOSS BLACK**

**F. MAGNUM 5 SPROCKET COVER**

Styled to match the distinctive Magnum 5 Custom Wheel. Available in mirror-chrome or gloss black, this Sprocket Cover gives the appearance of having a custom sprocket at a fraction of the cost. Cover is easy to install with Original Equipment hardware or add the Chrome Hardware Kit P/N 94773-07 (sold separately) for a finished look.

Fits '07-later Dyna models (except FLD).  
**40120-09** Chrome. **\$54.95**  
**42200010** Gloss Black. **\$54.95**

**G. SPROCKET COVER WITH HOLES – CHROME**

Chrome sprocket cover matches the styling of the Original Equipment sprocket. Gives the appearance of having a chrome sprocket at a fraction of the cost.

**91346-00** 70-Tooth Sprocket. **\$49.95**  
Fits '00-'05 Dyna models.

**91733-85A** 70-Tooth Sprocket. **\$54.95**  
Fits '91-'99 Dyna models. Also fits '80-'99 Domestic 1340 models except '93 and '95-'99 Softail® models. '94 Domestic Softail models are equipped with 70-tooth rear sprockets. Also fits all '94-'99 International 1340 models (except International Softail and Swiss 1340 models).

**H. SPROCKET HARDWARE – CHROME HEX HEAD**

This kit includes highly-polished, chrome-plated, grade 8 hex-head screws with chrome-plated washers, providing an extra custom accent. The perfect addition to the new chrome sprocket. Made from the same Original Equipment bolts to ensure product integrity. Also works with chrome belt sprocket covers and Original Equipment sprockets.

**94773-07** **\$29.95**  
Fits '07-later Dyna and Softail models.

**94773-00A** **\$29.95**  
Fits '00-'06 Softail and '00-'05 Dyna models.

**94708-98** **\$29.95**  
Fits '93-'99 Softail, '93-'99 Dyna and '91-later XL models.



**F. MAGNUM 5 SPROCKET COVER – CHROME**



**F. MAGNUM 5 SPROCKET COVER – GLOSS BLACK**



**G. SPROCKET COVER WITH HOLES – CHROME**



**H. SPROCKET HARDWARE – CHROME HEX HEAD**

*Notice: The prices appearing in this catalog are the manufacturer's suggested retail prices. Actual retail prices may vary.*

GENUINE MOTOR PARTS &amp; ACCESSORIES



2015

## SOFTAIL®

The sleek and stylish Softail® motorcycle family offers a classic "hard-tail" look with a smooth, contemporary ride. It packs all the punch of our legendary heritage with today's top technology and performance.







SOFTAIL

## BREAKOUT®

FXSB | PRODUCTION COLOR: CHARCOAL PEARL

Every inch of this Breakout® model screams custom. We've given it the full-black treatment, with custom engine covers, Burst Collection controls, contrast chrome Turbine wheels and a jet black Screamin' Eagle® exhaust. And for function, the Reduced Reach seat puts you a little closer to the controls without changing the long, low hot-rod profile.

SEE WHAT'S ON THIS BIKE AT [H-D.COM/GALLERY](https://www.harley-davidson.com/gallery)





SOFTAIL®

## SOFTAIL SLIM®

FLS | PRODUCTION COLOR: RADIOACTIVE GREEN

This sultry Softail Slim® motorcycle takes a decidedly bobber turn with its blacked-out engine, black front end, 16" Fat Ape bars\*, and the distressed leather and brass Bobber solo spring saddle. The Tribal Collection controls complete the retro 1950s custom look, perfect for riding from the drive-in or diner to your favorite late-night hot spot.

SEE WHAT'S ON THIS BIKE AT [H-D.COM/GALLERY](https://www.harley-davidson.com/gallery)

\*Handlebar height is regulated in many areas. Check local laws before installing.





SOFTAIL®

## HERITAGE SOFTAIL® CLASSIC

FLSTC | PRODUCTION COLOR: AMBER WHISKEY/CHARCOAL PEARL

Never before has so much classic styling concealed so much practicality and versatility. From the wide Beach Handlebar to the deep bucket seat, this is one smooth and comfortable touring ride. And in seconds, the detachable windshield, saddlebags, passenger pillion, and backrest are gone, leaving just what you need to hit the town in style.

SEE WHAT'S ON THIS BIKE AT [H-D.COM/GALLERY](https://www.harley-davidson.com/gallery)





SOFTAIL®

# FAT BOY®

FLSTF | PRODUCTION COLOR: MYSTERIOUS RED SUNGLO

Solid wheels are a Fat Boy® motorcycle's signature, so the wide-open Stinger wheels on this custom ride really grab your attention. The sparkling chrome front end, beefy Freight Train headlamp nacelle and fat Beach handlebar add some flash, while the Screamin' Eagle® Ventilator Elite air cleaner cover and performance mufflers add some muscle.

SEE WHAT'S ON THIS BIKE AT [H-D.COM/GALLERY](https://www.harley-davidson.com/gallery)





SOFTAIL®

## FAT BOY® LO

FLSTFB | COLORSHOP CUSTOM PAINT: LIMITED-MIDNITE BLAZE

Take a close look at the striking Midnite Blaze limited custom paint set. See the copper tone sparkling underneath the black? Look again, when the sun hits it, you'll get a glimpse. That is, assuming you can take your eyes off the 16" Fat Ape bar\*, an unexpected touch that helps make this blacked-out Fat Boy Lo® motorcycle a sight to behold.

SEE WHAT'S ON THIS BIKE AT [H-D.COM/GALLERY](https://www.harley-davidson.com/gallery)

\*Handlebar height is regulated in many areas. Check local laws before installing.





SOFTAIL®

## SOFTAIL® DELUXE

FLSTN | PRODUCTION COLOR: HARD CANDY CANCUN BLUE FLAKE

Dive in, the water's fine. White Nostalgic hand grips, White Diamond solo spring saddle, and wide whitewall tires keep things light in 1950s style. The chrome front end, chrome swingarm, and the sky-high Fat Ape handlebar\* add some shine, while the Daymaker™ Reflector LED Headlamp and curved license plate frame look great coming and going.

SEE WHAT'S ON THIS BIKE AT [H-D.COM/GALLERY](https://www.harley-davidson.com/gallery)

\*Handlebar height is regulated in many areas. Check local laws before installing.



FAT BOY® LO TRANSFORMATION

The Fat Boy® model is a true landmark in custom styling. Combining hardtail lines with solid wheels and beefy tires presents a profile that is the ideal canvas for creating your work of art.

EYE OPENER

They say that dark is just the absence of light, but this blacked-out beauty radiates a glow all its own. The Charcoal Pearl paint serves as the perfect backdrop, and the black fork sliders and Screamin' Eagle® slip-on mufflers focus your attention on the heart of the bike: the satin-finished

Twin Cam engine. The fat drag handlebar, hand controls, foot controls and the Solo Spring Saddle continue the blacked-out theme, while the machined aluminum accents of the Burst Collection grips, air cleaner and axle covers provide just the right amount of pop.



Parts list available at [h-d.com/gallery](http://h-d.com/gallery)



FIT

The combination of drag-style handlebars, Solo Spring Saddle and floorboards place the rider in an aggressive riding posture—perfect for attacking urban riding conditions. And the Profile® Low front suspension helps you plant your feet at the next light.



FUNCTION

Want to ride cross-country? Your trip is less than an hour away. Simply remove the spring seat hardware, reinstall the Original Equipment seat, pop on an H-D® Detachables™ windshield and backrest, and hit the road.



CARE AND MAINTENANCE

While it's tempting to use standard "auto parts store" cleaning and service supplies, hold out for the real thing. Genuine Harley-Davidson® coolant, oils, filters, batteries and service parts are engineered for the unique surfaces and operating conditions your Harley® motorcycle will encounter.



BURST COLLECTION AIR CLEANER



GLOSS BLACK HORN COVER & PHAT PLUG WIRES



STYLE

Black is the new chrome. With a mix of gloss black, flat black and satin silver, the almost total absence of brightwork on this Fat Boy® model makes a statement all its own. The look is all business, and just a little bad-ass.



PERFORMANCE

Tough look, nice sound. The free-breathing Screamin' Eagle® Burst air cleaner and Street Performance mufflers move a lot of air, and work together to deliver improved low end grunt and passing power you can feel.



CRAFTSMANSHIP

We design and build the bikes, so we don't need to "reverse-engineer" parts to try and make them fit. Everything we make is rigorously tested to ensure it meets our high standards, and the finishes of our accessories match the bike's surfaces for a consistent appearance.



LEATHER SWINGARM SADDLEBAG



BURST HAND GRIPS & FLUSH MOUNT FUEL GAUGE

## 216 SOFTAIL®

### Windshields

#### A. WIND SPLITTER VENTED WINDSHIELD

Reduce helmet buffeting at speed. The Harley-Davidson® Detachables™ Wind Splitter Vented Windshield features an exclusive fingertip-adjustable center vent that reduces turbulence behind the windscreen. When open, the controlled airflow fills the negative pressure area behind the shield and helps to smooth the flow of air over the top of the screen and around the rider. The revised flow reduces helmet bobbing and neck fatigue so you can comfortably spend more time in the saddle. The open vent also provides cooling airflow to the rider at low speeds and in city traffic.

Engineered to provide the riding comfort of a larger windshield, this low-profile screen's contemporary contour sets it apart from the crowd. The shape keeps the windshield below your siteline so you don't look through bugs and road grime and the detachable design means you can ride without the shield when the mood strikes. The shield is formed of hard-coated polycarbonate for strength and scratch resistance and the dark-smoked finish reduces glare. The slim polished stainless steel brackets mount to the Original Equipment rubber isolated docking points for ease of installation and removal.

**57400159** **\$429.95**

Fits '00-later FLSTC and FLST, FLSTF, FLSTFB, FLSTN models equipped with auxiliary lighting. Does not fit with Custom Auxiliary Lighting Kit P/N 68000051 or with Mini Tach or Boom!™ Audio Cruiser Speakers. Windshields dimensions: Overall height – 22.4", height from headlamp opening – 16.1", width – 20.3".



A. WIND SPLITTER VENTED WINDSHIELD



A. WIND SPLITTER VENTED WINDSHIELD

*Notice: The prices appearing in this catalog are the manufacturer's suggested retail prices. Actual retail prices may vary.*



# SOFTAIL® 217

Windshields

## B. VENTILATOR H-D® DETACHABLES™ WINDSHIELD

In a nutshell, a windshield should provide a barrier between the rider and errant bugs, discarded cigarette butts, flying debris and bad air. The shield should manage airflow and wind blasts to create a pocket of still air for both rider and passenger comfort. But if you ride in a warm climate or spend time at low speeds stuck in traffic, you need to keep some air circulating around your body to stay comfortable. The Ventilator Windshield features clear injection-molded vents that allow you to adjust the airflow to match the riding conditions. Opening the vents redirects the air across your chest for a cooling effect and closing the vents provides maximum wind and weather protection. But when you want to ride "naked," the detachable shield can be removed completely and reinstalled in seconds to match your riding mood.

**57400027** 20" Clear. **\$429.95**

Fits '86-later FLSTC, '00-later FLSTF, FLSTFB, '05-later FLS, FLST and FLSTN models with auxiliary lamps. Does not fit with Custom Auxiliary Lighting Kit P/N 68000051.

Windshield dimensions: Overall height – 27.0", width – 22.0".

**57400028** 20" Clear. **\$479.95**

Fits '93-'05 FXDWG and '86-later FXST, FXSTC and FXSTB models. Windshield dimensions: Overall height – 24.8"; width – 21.3".



B. VENTILATOR KING-SIZE H-D DETACHABLES WINDSHIELD – FL SOFTAIL



B. VENTILATOR COMPACT H-D DETACHABLES WINDSHIELD – FX SOFTAIL

SOFTAIL

*Notice: The prices appearing in this catalog are the manufacturer's suggested retail prices. Actual retail prices may vary.*

# 218 SOFTAIL®

Windshields – FX Softail

## A. H-D® DETACHABLES™ SUPER SPORT WINDSHIELD

Super is an apt description for this do-it-all shield. Detachable convenience. Harley-Davidson sport styling. High-quality, light smoke polycarbonate shields you from the elements. The windshield mounts to the fork tubes with H-D® Detachables™ Docking Hardware (sold separately) for easy on-and-off convenience and a quick return to a sporting profile.

**57965-97A** 18" Light Smoke. **\$229.95**  
Fits '84-later FXST, FXSTC, FXSTB, '93-'05 FXDWG, '80-'86 FXWG. (Does not fit FXSTD.) Use Docking Hardware Kit P/N 58350-96. Windshield dimensions: Overall height – 22.3"; width – 17.8".

**57969-97A** 13" Light Smoke. **\$229.95**  
Fits '93-later FXSTS, FXSTSB, FXSTSSE models. Use Docking Hardware Kit P/N 58907-96B. Will not fit with Chrome Billet Mini Tach Mounts. Windshield dimensions: Overall height – 22.8"; width – 17.7".

**57837-00A** 18" Light Smoke. **\$259.95**  
Fits '00-'07 FXSTD models (except FXSTDSE). Installation requires the separate purchase of Docking Hardware Kit P/N 58397-00. Windshield dimensions: Overall height – 22.9"; width – 18.3".

### Shown with: DOCKING HARDWARE FOR H-D DETACHABLES WINDSHIELDS

**58907-96B** Springer™ – Polished. **\$79.95**  
Required for installation of H-D Detachables Windshields on '93-later FXSTS, FXSTSSE, FXSTSB, '97-later FLSTS, FLSTSB and FLSTSC models.

**58350-96** For 41mm Forks. **\$79.95**  
Required for installation of H-D Detachables Windshields on '84-later FXST, FXSTC, FXSTB, '93-'05 FXDWG, '80-'86 FXWG models. (Does not fit FXSTD.)

**58397-00** For Softail® Deuce™. **\$79.95**  
Required for installation of H-D Detachables Windshields on '00-'07 FXSTD models (except FXSTDSE).

## B. QUICK-RELEASE SUPER SPORT WINDSHIELD

Reduces the pounding wind and shower of bugs, but keeps the wind-in-the-hair feeling. Ideal for a cool morning ride, the sleek profile of the Super Sport Windshield hugs the front headlamp for a sporty look. The windshield mounts to the fork tubes with elegant die-cast lever-locking clamps, so the windshield does not require any "leave-behind" docking hardware. You get quick on-and-off convenience and a clean, custom look. No tools are required and the kit includes everything needed to install the windshield.

Fits '07-'08 FXDSE and '00-later FXST, FXSTB and FXSTC models equipped with Custom Inverted Front Fork Kit P/N 46321-05, 46321-05A or 48646-06.

**57331-07** 16" Light Smoke. **\$359.95**  
Windshield dimensions: Overall height – 22.1"; width – 15.3".

Fits '08-later FXCW and FXCWC models.

**57251-08** 20" Clear. **\$379.95**  
Windshield dimensions: Overall height – 24.2"; width – 16.8".

**57253-08** 16" Light Smoke. **\$379.95**  
Windshield dimensions: Overall height – 20.2"; width – 15.2".

Fits '06-later FXDWG and '13-later FXSB and FXSBSE models.

**57301-06** 19" Light Smoke. **\$349.95**  
Windshield dimensions: Overall height – 25.0"; width – 20.1".

## C. SPORT WINDSHIELD KIT

Formed of polycarbonate and hard-coated to resist scratching. Light smoke windshield is contoured to fit headlamp and incorporates adjustable four-point mounting. Functional styling helps deflect wind to reduce upper body fatigue.

**91820-85A** 17" Light Smoke. **\$164.95**  
Fits '84-later FXST, FXSTB, FXSTC and '93-'05 FXDWG and '86-earlier FXWG models. Windshield dimensions: Overall height – 20.0"; width – 15.0".



A. H-D DETACHABLES SUPER SPORT WINDSHIELD



B. QUICK-RELEASE SUPER SPORT WINDSHIELD FOR ROCKER MODELS – 20" CLEAR



C. SPORT WINDSHIELD KIT

Notice: The prices appearing in this catalog are the manufacturer's suggested retail prices. Actual retail prices may vary.



# SOFTAIL® 219

Windshields – FX Softail

## D. QUICK-RELEASE COMPACT WINDSHIELD

Combine the classic Harley-Davidson® windshield shape with a revolutionary new attachment system and you have the best of style and function. The windshield mounts to the fork tubes with elegant die-cast lever-release clamps, so the windshield does not require any "leave-behind" docking hardware. You get quick on-and-off convenience and a clean, custom look. No tools are required and the kit includes everything needed to install the windshield. The tough, hard-coated polycarbonate windshield is available in your choice of traditional polished or gloss black horizontal and vertical braces.

Fits '93-'05 FXDWG and '86-later FXST, FXSTC and FXSTB models.

**59802-05** 19" Clear – Polished Braces. **\$429.95**  
Windshield dimensions: Overall height – 23.8"; width – 21.4".

**58360-09** 19" Clear – Black Braces. **\$459.95**  
Windshield dimensions: Overall height – 23.8"; width – 21.4".

**58751-05** 19" Light Smoke – Polished Braces. **\$449.95**  
Windshield dimensions: Overall height – 23.8"; width – 21.4".

**57199-05** 16" Light Smoke – Polished Braces. **\$439.95**  
Windshield dimensions: Overall height – 20.8"; width – 21.4".

**58376-09** 16" Light Smoke – Black Braces. **\$469.95**  
Windshield dimensions: Overall height – 20.8"; width – 21.4".

Fits '11-'13 FXS models.

**57400021** 19" Clear – Black Braces. **\$429.95**  
Windshield dimensions: Overall height – 23.8"; width – 21.4".

**57400022** 16" Light Smoke – Black Braces. **\$434.95**  
Windshield dimensions: Overall height – 20.8"; width – 21.4".

Fits '06-later FXDWG and '13-later FXSB and FXSBSE models.

**58387-06** 18" Clear – Polished Braces. **\$369.95**  
Windshield dimensions: Overall height – 26.8"; width – 19.5".

**58413-06** 18" Light Smoke – Polished Braces. **\$389.95**  
Windshield dimensions: Overall height – 26.8"; width – 19.5".

**58444-06** 14" Light Smoke – Polished Braces. **\$389.95**  
Windshield dimensions: Overall height – 22.8"; width – 19.5".

Also available:

### TURN SIGNAL RELOCATION KIT

Styled to blend with the lower triple clamp. This chrome-plated Turn Signal Relocation Kit moves the Original Equipment bullet-style turn signals from the handlebar to the front fork for a clean, streamlined look. Kit includes left and right mounting stalk and all required hardware.

**58742-05** **\$59.95**

Fits '93-'05 FXDWG, '86-later FXST, FXSTC, FXSTB and '00-'07 FXSTD models.



D. QUICK-RELEASE COMPACT WINDSHIELD – POLISHED BRACES  
(SHOWN WITH TURN SIGNAL RELOCATION KIT)



D. QUICK-RELEASE COMPACT WINDSHIELD – GLOSS BLACK BRACES

SOFTAIL

Notice: The prices appearing in this catalog are the manufacturer's suggested retail prices. Actual retail prices may vary.

# 220 SOFTAIL®

Windshields – FX Softail

## A. QUICK-RELEASE COMPACT WINDSHIELD – DEUCE™

Combine the classic Harley-Davidson® windshield shape with a revolutionary new attachment system and you have the best of style and function. The windshield mounts to the fork tubes with elegant die-cast lever-release clamps, so the windshield does not require any "leave-behind" docking hardware. You get quick on-and-off convenience and a clean, custom look. No tools are required and the kit includes everything needed to install the windshield. The tough, hard-coated polycarbonate windshield features traditional chrome horizontal and vertical braces.

Fits '00-'07 FXSTD models (except FXSTDSE).

**57160-05** 19" Light Smoke. **\$469.95**

Windshield dimensions: Overall height – 26.3"; width – 19.5".

**58779-05** 19" Clear. **\$444.95**

Windshield dimensions: Overall height – 26.3"; width – 19.5".



A. QUICK-RELEASE COMPACT WINDSHIELD – DEUCE (19" CLEAR SHOWN)



B. H-D DETACHABLES COMPACT WINDSHIELD FOR MODELS WITH AUXILIARY LIGHTING

## B. H-D® DETACHABLES™ COMPACT WINDSHIELD FOR MODELS WITH AUXILIARY LIGHTING

Dress up or down with the convenience of a H-D® Detachables™ Windshield. This compact-style windshield is designed to fit models equipped with Auxiliary Lighting Kit P/N 68268-03A or 69285-05.

**58865-03** 18" Clear. **\$299.95**

Fits '93-'05 FXDWG and '84-later FXST, FXSTC, FXSTB

models. Requires separate purchase of Docking Hardware Kit P/N 58361-03. Windshield dimensions: Overall height – 21.9";

width – 21.4".

## C. WINDSHIELD DOCKING HARDWARE AND TURN SIGNAL RELOCATION KIT

Required for installation of H-D Detachables Windshields on FXDWG and FXST models equipped with Auxiliary Lighting Kits. Includes windshield mounting hardware and turn signal relocation hardware.

**58361-03** **\$89.95**

Fits '93-'05 FXDWG and '84-later FXST, FXSTC, FXSTB

models equipped with Auxiliary Lighting Kits.



C. WINDSHIELD DOCKING HARDWARE AND TURN SIGNAL RELOCATION KIT

## D. TURN SIGNAL RELOCATION KIT

Styled to blend with the lower triple clamp. This chrome-plated Turn Signal Relocation Kit moves the Original Equipment bullet-style turn signals from the handlebar to the front fork for a clean, streamlined look. Kit includes left and right mounting stalk and all required hardware.

**58742-05** **\$59.95**

Fits '93-'05 FXDWG, '86-later FXST, FXSTC, FXSTB and '00-'07 FXSTD models.



D. TURN SIGNAL RELOCATION KIT

## E. LOCKING QUICK-RELEASE WINDSHIELD CLAMP

Protect your investment. This Locking Quick-Release Windshield Clamp secures your windshield from grab-and-run theft, giving you peace of mind when you have to leave your bike unattended. The chrome-plated locking clamp replaces one of the Original Equipment windshield clamps and features a push-button lock with a mini barrel-style key for easy removal. Kit includes one locking clamp and two matching keys.

**57400007** 41mm. **\$29.95**

Fits '93-'05 FXDWG and '88-later FXS, FXST, FXSTB and

FXSTC models equipped with quick-release style detachable windshields.



E. LOCKING QUICK-RELEASE WINDSHIELD CLAMP



Notice: The prices appearing in this catalog are the manufacturer's suggested retail prices. Actual retail prices may vary.



# SOFTAIL® 221

Windshields – Springer



**F. H-D DETACHABLES COMPACT WINDSHIELD – POLISHED (15" CLEAR SHOWN)**



**F. H-D DETACHABLES COMPACT WINDSHIELD – GLOSS BLACK (11" LIGHT SMOKE SHOWN)**



**G. KING-SIZE H-D DETACHABLES WINDSHIELD FOR HERITAGE SPRINGER MODELS – 18" CLEAR**

## F. H-D® DETACHABLES™ COMPACT WINDSHIELD FOR SOFTAIL® SPRINGER™ MODELS

Get the convenience of detachables and the traditional Harley-Davidson look in one easy-to-install windshield. This windshield is formed from a hard-coated polycarbonate that resists scratching and abrasion. Equipped with H-D® Detachables™ docking hardware, the windshield can be installed or removed in seconds without tools, keeping your bike ready for the open road or for a run down Main Street. Available with your choice of traditional polished or sinister gloss black vertical and horizontal braces, these windshields blend with your customizing style.

Fits '08-later FLSTSB models. Installation requires separate purchase of Windshield Docking Hardware Kit P/N 58907-96B (chrome) or 58165-09 (black).

**57701-08** 15" Clear – Polished Braces. **\$319.95**

Windshield dimensions: Overall height – 26.8"; width – 19.7".

**58073-09** 15" Clear – Black Braces. **\$329.95**

Windshield dimensions: Overall height – 26.8"; width – 19.7".

**57702-08** 11" Light Smoke – Polished Braces. **\$329.95**

Windshield dimensions: Overall height – 22.8"; width – 19.7".

**58161-09** 11" Light Smoke – Black Braces. **\$359.95**

Windshield dimensions: Overall height – 22.8"; width – 19.7".

Fits '93-later FXSTS, FXSTSB and FXSTSSE, '97-'03 FLSTS and '05-'07 FLSTSC models. Installation requires separate purchase of Windshield Docking Hardware Kit P/N 58907-96B (chrome) or 58165-09 (black). (Will fit with or without auxiliary lighting.) Will not fit with Chrome Billet Mini Tach Mounts.

**58770-96** 18" Clear – Polished Braces. **\$319.95**

Windshield dimensions: Overall height – 26.8"; width – 19.9".

**58771-96** 14" Light Smoke – Polished Braces. **\$339.95**

Windshield dimensions: Overall height – 22.8"; width – 19.9".

### Shown with: DOCKING HARDWARE FOR H-D DETACHABLES WINDSHIELDS

Required for installation of H-D Detachables Windshields on '93-later FXSTS, FXSTSSE, FXSTSB, '97-later FLSTS, FLSTSB and FLSTSC models.

**58907-96B** Springer™ – Polished. **\$79.95**

**58165-09** Springer – Black. **\$89.95**

## G. KING-SIZE H-D DETACHABLES WINDSHIELD FOR HERITAGE SPRINGER® MODELS

This one-piece windshield is formed from hard-coated polycarbonate material to resist scratching. The shield is attached to highly-polished stainless steel mounting brackets supported by molded-rubber bushings for improved isolation.

**58772-97** 18" Clear. **\$319.95**

Fits '97-'03 FLSTS and '05-'07 FLSTSC models. Installation requires the separate purchase of Windshield Docking Hardware Kit P/N 58907-96B. Will not fit with Chrome Billet Mini Tach Mounts. Windshield dimensions: Overall height – 27.0"; width – 23.1".

SOFTAIL

Notice: The prices appearing in this catalog are the manufacturer's suggested retail prices. Actual retail prices may vary.

## 222 SOFTAIL®

Windshields – FL Softail

### A. KING-SIZE H-D® DETACHABLES™ WINDSHIELD FOR FL SOFTAIL® MODELS – POLISHED BRACES

Styled to complement the beefy FL Softail® front headlamp, this windshield can be installed or removed in seconds without tools, keeping your bike ready for the open road or for a run down Main Street. The windshield is formed from hard-coated polycarbonate to resist scratching and abrasion and is available with traditional polished braces and mounting brackets to blend with your customizing style. Mounting brackets are supported by molded-rubber bushings for improved isolation. Windshield kit includes all the hardware.

Fits '86-'99 FLSTC, '90-later FLS, FLSTF, FLSTFB, '06 FLST and '93-'96 FLSTN models without auxiliary lamps. Does fit with Custom Auxiliary Lighting Kit P/N 68000051. (Does not fit Springer™ models.)

**58243-95** 21" Clear – Polished Braces. **\$369.95**  
Windshield dimensions: Overall height – 26.3"; width – 23.1".

**58278-95** 18" Light Smoke – Polished Braces. **\$389.95**  
Windshield dimensions: Overall height – 23.4"; width – 23.1".

Fits '00-later FLS, FLST, FLSTC, FLSTF, FLSTFB and FLSTN models equipped with auxiliary lighting. Does not fit with Custom Auxiliary Lighting Kit P/N 68000051. Includes mounting hardware.

**57400114** 23" Clear – Polished Braces. **\$379.95**  
Windshield dimensions: Overall height – 28.3"; width – 23.1".

**57400112** 21" Clear – Polished Braces. **\$389.95**  
Windshield dimensions: Overall height – 26.3"; width – 23.1".

**57400115** 18" Clear – Polished Braces. **\$359.95**  
Windshield dimensions: Overall height – 23.4"; width – 23.1".

**57400113** 18" Light Smoke – Polished Braces. **\$389.95**  
Windshield dimensions: Overall height – 23.4"; width – 23.1".

Fits '00-later FLS, FLST, FLSTC, FLSTF, FLSTFB and FLSTN models equipped with auxiliary lighting. '00-later FLS, FLST, FLSTF, FLSTFB and FLSTN models require separate purchase of Docking Hardware Kit P/N 91800025. Does not fit with Custom Auxiliary Lighting Kit P/N 68000051.

**57061-09** 16" Clear – Polished Braces. **\$319.95**  
Windshield dimensions: Overall height – 23.4"; width – 23.1".

Fits '86-'99 FLSTC and '90-'99 FLSTF, FLSTFB, '93-'96 FLSTN models with auxiliary lighting. Includes mounting hardware. (Does not fit Springer models.)

**57749-04** 23" Clear – Polished Braces. **\$379.95**  
Windshield dimensions: Overall height – 28.3"; width – 23.1".

**58240-95** 21" Clear – Polished Braces. **\$359.95**  
Windshield dimensions: Overall height – 26.3"; width – 23.1".

**58628-99** 21" Light Smoke – Polished Braces. **\$389.95**  
Windshield dimensions: Overall height – 26.3"; width – 23.1".

**58275-95** 18" Light Smoke – Polished Braces. **\$389.95**  
Windshield dimensions: Overall height – 23.4"; width – 23.1".

### B. KING-SIZE H-D DETACHABLES WINDSHIELD FOR FL SOFTAIL MODELS – GLOSS BLACK BRACES

Designed to be installed or removed without tools in seconds, a detachable windshield gives you the freedom to define your ride at the drop of a hat. Ride across the country protected from the elements, then quickly remove the windshield to hit the streets in style. This one-piece windshield is formed from hard-coated polycarbonate material to resist scratching. The shield is attached to stainless steel mounting brackets supported by molded-rubber bushings for improved isolation. Windshields are available with contemporary gloss black braces and mounting brackets and in a variety of heights to match your size and riding style.

Fits '00-later FLS, FLST, FLSTC, FLSTF, FLSTFB and FLSTN models equipped with auxiliary lighting. Does not fit with Custom Auxiliary Lighting Kit P/N 68000051. Includes mounting hardware.

**57400110** 21" Clear – Black Braces. **\$359.95**  
Windshield dimensions: Overall height – 26.3"; width – 23.1".

**57400111** 18" Light Smoke – Black Braces. **\$389.95**  
Windshield dimensions: Overall height – 23.4"; width – 23.1".

Fits '86-'99 FLSTC, '90-later FLS, FLSTF, FLSTFB, '06 FLST and '93-'96 FLSTN models without auxiliary lamps. Does fit with Custom Auxiliary Lighting Kit P/N 68000051. (Does not fit Springer models.)

**57688-10** 21" Clear – Black Braces. **\$359.95**  
Windshield dimensions: Overall height – 26.3"; width – 23.1".

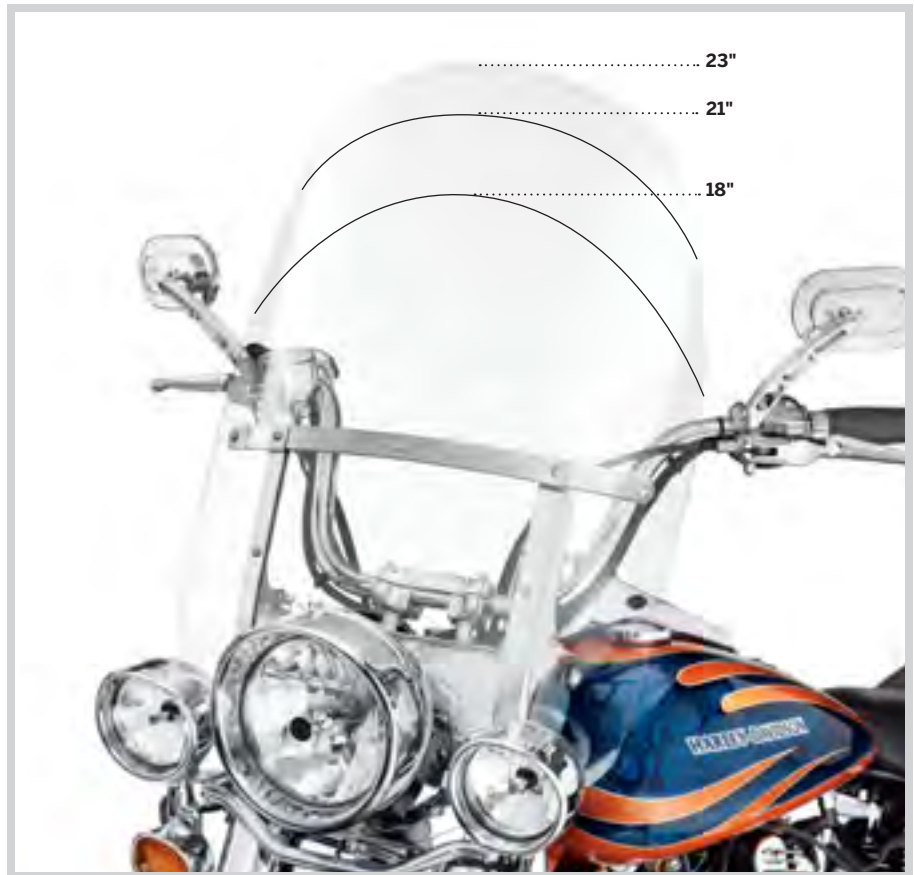

A. KING-SIZE H-D DETACHABLES WINDSHIELD FOR FL SOFTAIL MODELS WITH AUXILIARY LIGHTING – POLISHED BRACES

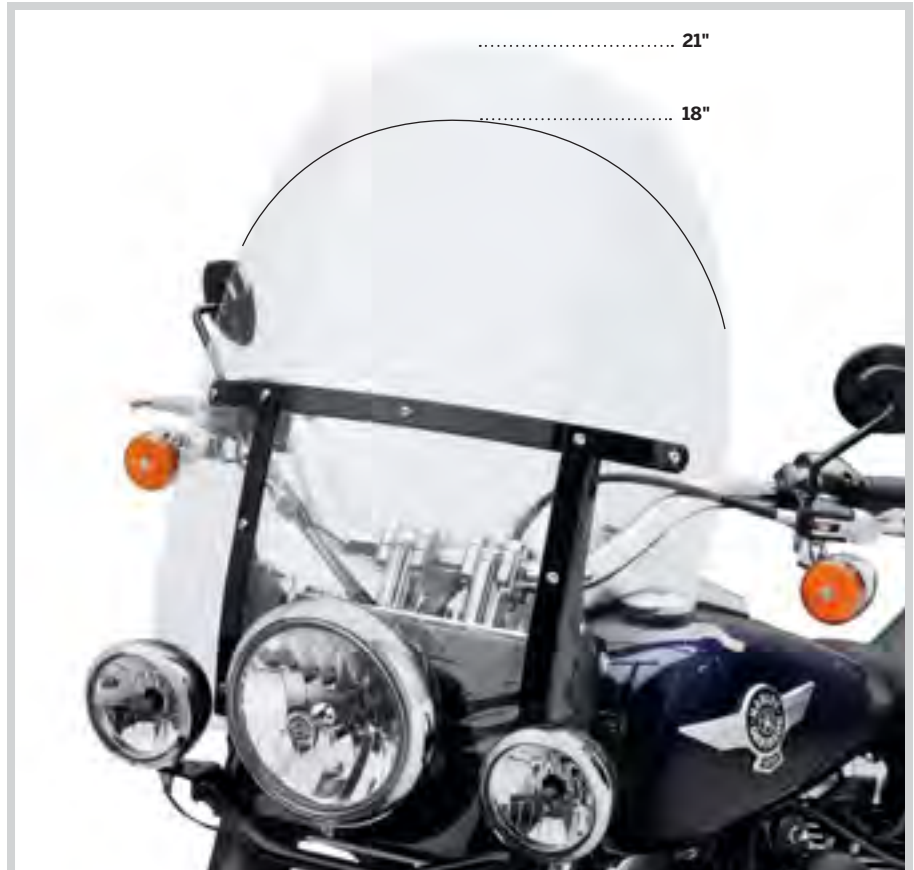

B. KING-SIZE H-D DETACHABLES WINDSHIELD FOR FL SOFTAIL MODELS WITH AUXILIARY LIGHTING – GLOSS BLACK BRACES

*Notice: The prices appearing in this catalog are the manufacturer's suggested retail prices. Actual retail prices may vary.*



# SOFTAIL® 223

Windshields – FL Softail



21"

18"

C. KING-SIZE NOSTALGIC H-D DETACHABLES WINDSHIELD FOR FL SOFTAIL MODELS

### C. KING-SIZE NOSTALGIC H-D® DETACHABLES™ WINDSHIELD FOR FL SOFTAIL® MODELS

Formed from hard-coated polycarbonate to resist scratching, this one-piece windshield features a nostalgic horseshoe-shaped outer brace with stylized Bar & Shield logo. The highly polished mounting brackets attach easily with the included mounting hardware and after initial installation, the windshield can be removed and re-attached without tools in seconds. H-D® Detachables™ Windshields are available in 21" and 18" versions to match your need for wind protection.

Fits '05-later FLS and FLSTN, '86-later FLSTC, '00-later FLSTF, FLSTFB and '06 FLST models with or without auxiliary lamps. Does not fit with Custom Auxiliary Lighting Kit P/N 68000051. Additional mounting hardware not required.

**57140-05** 21" Clear. **\$389.95**  
Windshield dimensions: Overall height – 26.3"; width – 23.1".

**57141-05** 18" Light Smoke. **\$409.95**  
Windshield dimensions: Overall height – 23.4"; width – 23.1".

### D. KING-SIZE H-D DETACHABLES WINDSHIELD FOR NACELLE-EQUIPPED MODELS WITHOUT AUXILIARY LIGHTING

This one-piece polycarbonate windshield is designed with a larger diameter opening to wrap around the contour of the Freight Train Headlamp Nacelle Kit. Full length windshield will not fit with Original Equipment or accessory Auxiliary Lamp Kits.

Fits '86-later FLS, FLSTC, FLSTF, FLSTFB, '06 FLST and '93-'96 FLSTN models equipped with the Chrome Headlamp Nacelle Kit P/N 67907-96B. Fits without auxiliary lamps.

**58652-97A** 19" Clear. **\$379.95**  
Windshield dimensions: Overall height – 26.3"; width – 23.1".

**58653-97A** 16" Light Smoke. **\$399.95**  
Windshield dimensions: Overall height – 23.4"; width – 23.1".

Also available:

### KING-SIZE H-D DETACHABLES WINDSHIELD FOR NACELLE-EQUIPPED MODELS WITH AUXILIARY LIGHTING

This one-piece polycarbonate windshield is designed with a larger diameter opening to wrap around the contour of the Freight Train Headlamp Nacelle Kit. Windshield is shaped to accept Original Equipment or accessory Auxiliary Lamp Kits.

Fits '86-later FLS, FLSTC, FLSTF, FLSTFB, '06 FLST and '93-'96 FLSTN models equipped with the Chrome Headlamp Nacelle Kit P/N 67907-96B. Fits with auxiliary lamps.

**58649-97A** 19" Clear. **\$379.95**  
Windshield dimensions: Overall height – 26.3"; width – 23.1".

**58651-97A** 16" Light Smoke. **\$399.95**  
Windshield dimensions: Overall height – 23.4"; width – 23.1".



19"

16"

D. KING-SIZE H-D DETACHABLES WINDSHIELD FOR NACELLE-EQUIPPED MODELS WITHOUT AUXILIARY LIGHTING – 19" CLEAR

SOFTAIL

Notice: The prices appearing in this catalog are the manufacturer's suggested retail prices. Actual retail prices may vary.

# 224 SOFTAIL®

## Windshield Accessories

### A. REPLACEMENT WINDSHIELD SCREEN

Tailor your existing windshield for your riding preference. Replace the original windshield with a screen sized to improve wind protection. Uses your existing mounting brackets and hardware for an easy, economical conversion.

Fits '86-later FLS, FLSTC and FLSTF, '06 FLST and '93-'96 FLSTN models equipped with a H-D® Detachables™ King-Size Windshield. (Does not fit Springer™ models.)

<b>57754-04</b>	23" Clear.	<b>\$159.95</b>
<b>57975-99</b>	21" Light Smoke.	<b>\$159.95</b>
<b>58277-95</b>	18" Light Smoke.	<b>\$154.95</b>

Fits '86-later FLS, FLSTC and FLSTF, '06 FLST and '93-'96 FLSTN models equipped with the Chrome Headlamp Nacelle Kit P/N 67907-96B.

<b>58657-97A</b>	19" Clear.	<b>\$144.95</b>
<b>58658-97A</b>	16" Light Smoke.	<b>\$154.95</b>



**A. REPLACEMENT WINDSHIELD SCREEN**



**B. SKULL WITH WINGS WINDSHIELD TRIM KIT**



**C. WINDSHIELD ACORN NUT KIT**

### B. SKULL WITH WINGS WINDSHIELD TRIM KIT

This Trim Kit replaces the horizontal inner and outer trim strips of your current windshield with a new bar featuring a cast "Skull with Wings" logo. Kit includes inner and outer trim and mounting tape for easy installation.

**58691-04** **\$89.95**  
Fits '86-later FLS, FLSTC and FLSTF, '06 FLST and '94-later FLHR models equipped with King-Size Windshields.

### C. WINDSHIELD ACORN NUT KIT

Kit contains 10 chrome-plated low crown 12-24 acorn nuts.

**94111-95** **\$9.95**  
Fits Compact, King-Size, Convertible and Road King® windshields. (Pkg. of 10.)

### D. MID-FRAME AIR DEFLECTOR

Improve rider comfort during the summer riding season. Designed for severe duty and extreme temperature applications, these inconspicuous black deflectors attach to the frame and surround the top of the rear cylinder head. The scoop shape captures the moving air and uses the flow to direct the heat down and away from the rider to improve comfort. Kit includes all required mounting hardware.

**29200008A** **\$89.95**  
Fits '08-later Softail® models (except FXCW, FXCWC, FXSB and FXSBSE).

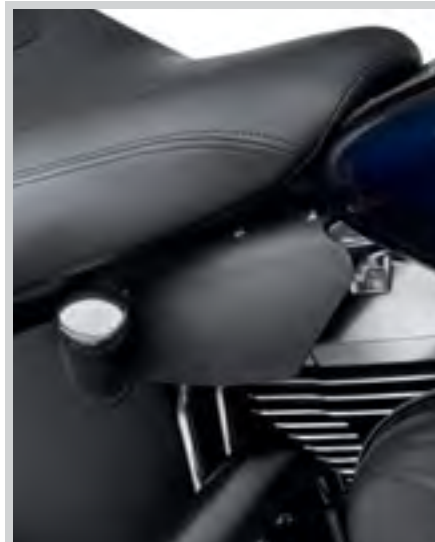

**D. MID-FRAME AIR DEFLECTOR**



**E. SOFT LOWERS**

### E. SOFT LOWERS

Extend your riding season. Full coverage Soft Lowers provide wind and mud protection for the rider's legs and boots and minimize cold updrafts as the weather changes. Covers are custom shaped to hug the engine guard to minimize flapping and they simply clip in place for speedy installation as the weather changes. Two-way zippered outer edge accommodates guard-mounted highway pegs in almost any position. Reflective piping provides added visibility and the rigid inner panel provides ample clearance around the foot controls.

**57100213** **\$109.95**

Fits FL Softail models equipped with Engine Guard P/N 49004-90 or 49004-00A. Does not fit Mustache or Nostalgic Engine Guards. Does not fit models with forward controls, Extended Reach Brake Lever or Extended Reach Shift Lever.

### F. FORK-MOUNT WIND DEFLECTORS – CHROME

Dress your bike for comfort and style. Wind Deflectors extend the windshield's coverage for superior protection in any weather. The scooped Deflectors are shaped to channel the air flow and direct the rush of air and turbulence around the rider. Deflectors attach to the fork brackets for a clean, integrated look and the chrome finish is the perfect complement to polished or chrome front end components. Easy to install kit includes all required mounting hardware.

**57400143** **\$99.95**

Fits '86-later FLS, FLST, FLSTC, FLSTF, FLSTFB, 10-'12 FLSTSE and '93-'96 FLSTN models equipped with Harley-Davidson® King-Size Windshield and/or Passing Lamp Kits. Does not fit Springer models.



**F. FORK-MOUNT WIND DEFLECTORS – CHROME**

*Notice: The prices appearing in this catalog are the manufacturer's suggested retail prices. Actual retail prices may vary.*



## SEAT OF POWER

The right seat is equal parts ergonomics and comfort. Its shape anchors your position and determines the reach to the ground and to the controls, and the padding supports your tailbone and hips to relieve stress and pressure. Pick the right one for you — and your passenger.

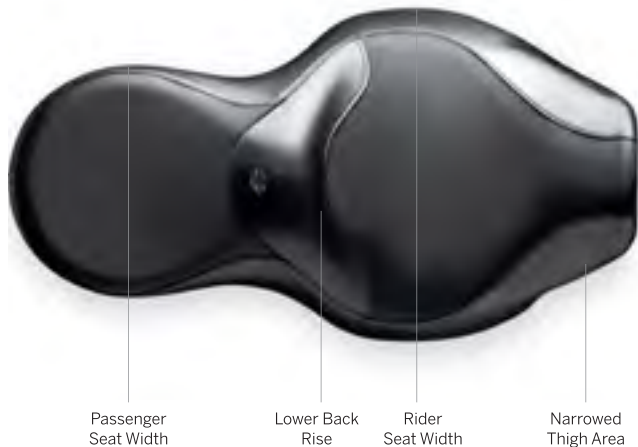

Passenger  
Seat Width

Lower Back  
Rise

Rider  
Seat Width

Narrowed  
Thigh Area

## PAMPER YOUR BEHIND



Experience ultimate comfort. Road Zeppelin® seat and seat pads are equipped with a unique air bladder system that distributed rider weight across the entire seating surface. By reducing pressure points and providing shock absorption, this pad allows you to ride your cool low profile seat for hundreds of miles. The mesh cover lets air to circulate beneath the rider's body, reducing the temperature between the rider and seat. The easy-to-reach integrated hand pump and air release valve permits quick and convenient adjustment.

## CHANGING YOUR SEAT



Switching out your seat is simple. And because certain rides call for certain styles, some folks like to have multiple seats to match the occasion. Install a comfortable, supportive touring seat for the longer treks, and swap it out for a low-profile seat for a night on the town. Please see your owner's manual for proper removal and installation of seats.

## SOFTAIL® SEAT TYPES

Solo or two-up, comfort or style, check out these seats to get an idea of where you want to sit.



### LOW-PROFILE SEATS

These saddles combine radical styling with a "deep-in-the-bike" riding position. Long and lean, Badlander®, Brawler® and Sidekick® seats bring you lower to the ground than most other seats.



### POSITION SEATS

Designed to place the rider in the best relationship to the controls, Reach® and Tallboy® seats position short and tall riders for a comfortable extension of the arms and legs.



### TOURING SEATS

Designed for comfort, Sundowner™, Signature Series® and other touring seats offer a broad seating surface to reduce pressure points and a dished shape holds you in place and provides additional back support.

## CUSTOM SEATING PROGRAM

A personalized seat is the perfect thread to tie your bike's attitude together. Select the stitching pattern, leather inlay and thread color that best support your custom movement and you'll have your personalized seat in just three weeks. For more details, turn to page 796, or visit [h-d.com/customseat](http://h-d.com/customseat).



# 226 SOFTAIL®

Seating – Solo

## A. BOBBER SOLO SADDLE

How low can you go? This minimalist solo seat takes the stripped-down garage-built look about as far as you can go. The thick distressed black leather cover is bonded directly to the formed metal seat pan and minimizes the foam filler and the extra height it brings. The raw-edge leather features brass rivets and “Milwaukee Since 1903” trim that will develop a rich patina with use and a Bar & Shield logo burned into the surface. Easy to install, the bolt-on seat and model-specific Installation Kit includes everything you need to get the bobber look. No cutting, welding or fabrication is necessary.

**52000180** Black Distressed Leather. **\$299.95**  
Fits '04-'06 XL, '10-later XL, '06-later Dyna® and '08-later FXS, FLS, FLSTC, FLSTN, FLSTF and FLSTFB models.  
Installation requires separate purchase of model-specific Rigid or Spring Seat Mounting Hardware Kit.

## B. SOLO SADDLE

Add nostalgic “bobber” looks to your modern Harley-Davidson® motorcycle. Available in elegant leather, this solo seat features a low-profile design that provides the minimalistic “just enough to ride” look. The smooth metal seat pan and the simple frame cover leave a clean, finished appearance. Easy to install, the bolt-on seat and model-specific Spring Seat Installation Kit include everything you need to get the bobber look. No cutting, welding or fabrication is necessary and the seat can be removed and replaced with a touring seat for a two-up night on the town.

Fits '04-'06 XL, '10-later XL, '06-later Dyna and '08-later FXS, FLS, FLSTC, FLSTN, FLSTF and FLSTFB models. Installation requires separate purchase of model-specific Rigid or Spring Seat Mounting Hardware Kit. Seat width 10.5”.

<b>54373-10</b>	Black Leather.	<b>\$299.95</b>
<b>54072-10</b>	Brown Leather.	<b>\$299.95</b>
<b>52000113</b>	White Diamond.	<b>\$299.95</b>
<b>52000114</b>	Black Diamond.	<b>\$299.95</b>

Shown with:

### SPRING SADDLE INSTALLATION KIT

The torsion-style springs are designed for the optimum balance between spring suspension and support. Required for installation of Solo Spring Saddle P/N 54072-10, 54373-10, 52000113, 52000114 or 52000180. Kit includes springs, mounting brackets, frame cover and hardware.

<b>52000014</b>		<b>\$279.95</b>
Fits '11-later FXS and FLS models.		
<b>54376-10</b>		<b>\$279.95</b>
Fits '08-later FLSTC and FLSTN models.		
<b>54377-10</b>		<b>\$279.95</b>
Fits '08-later FLSTF and FLSTFB models.		



**A. BOBBER SOLO SADDLE – BLACK DISTRESSED LEATHER  
(SHOWN WITH SPRING SADDLE INSTALLATION KIT)**



**B. SOLO SADDLE – WHITE DIAMOND  
(SHOWN WITH SPRING SADDLE  
INSTALLATION KIT)**

**B. SOLO SADDLE – BLACK DIAMOND  
(SHOWN WITH SPRING SADDLE  
INSTALLATION KIT)**



**B. SOLO SADDLE – BROWN LEATHER  
(SHOWN WITH SPRING SADDLE  
INSTALLATION KIT)**

**B. SOLO SADDLE – BLACK LEATHER  
(SHOWN WITH SPRING SADDLE  
INSTALLATION KIT)**

Notice: The prices appearing in this catalog are the manufacturer's suggested retail prices. Actual retail prices may vary.



# SOFTAIL® 227

Seating – Solo



C. STANDARD LEATHER SOLO SPRING SADDLE



D. DELUXE LEATHER SOLO SPRING SADDLE WITH NOSTALGIC SKIRT

## C. STANDARD LEATHER SOLO SPRING SADDLE

First offered in 1925, this timeless solo saddle offers a deep dish bucket shape and a firm leather covering. The wide seating surface and the narrow seat nose provide a surprisingly comfortable and supportive ride. Installation requires separate purchase of model-specific Seat Bracket and Spring Kit.

**52004-25** **\$269.95**

Fits '08-later FLSTSB, FXST, FXSTB, FXSTC and FXSTS models (except FXSTSSE/2/3) and '86-'94 Softail® models. Requires separate purchase of model-specific Mounting Hardware Kit P/N 51902-09 or 52225-89.

## D. DELUXE LEATHER SOLO SPRING SADDLE WITH NOSTALGIC SKIRT

Step back to the late 1940s. Styled to complement the look of the post-war Harley® models, this deep dished leather solo saddle features a firm but comfortable seating surface. The flexible skirt and chrome concho add a nostalgic touch. Installation requires separate purchase of model-specific Seat Bracket and Spring Kit.

**52006-47B** **\$269.95**

Fits '08-later FLSTSB, FXST, FXSTB, FXSTC and FXSTS models (except FXSTSSE/2/3) and '86-'94 Softail models. Requires separate purchase of model-specific Mounting Hardware Kit P/N 51902-09 or 52225-89.

**Also available:**

### SOLO SEAT BRACKET/SPRING KIT

This kit is required to install Touring Solo Saddle P/N 51481-08, Deluxe Leather Solo Saddle P/N 52006-47B or Leather Solo Saddle P/N 52004-25.

**51902-09** **\$229.95**

Fits '08-later FLSTSB, FXST, FXSTB and FXSTC models.

**52225-89** **\$229.95**

Fits '86-'94 Softail models.

## E. TUCK & ROLL SOLO SEAT

Original Equipment on the '12-later Softail Slim® model, this low-profile Solo Seat features classic "tuck & roll" style upholstery and a minimalistic look that is the perfect complement to the Softail FXS Blackline® model. Designed to sit you low in the bike, the seat's narrow nose and the frame-hugging shape brings you closer to the ground for a lean and mean riding profile. When you need two-up versatility, just add the available matching Passenger Pillion P/N 52400039.

**52000031A** **\$229.95**

Fits '11-'13 FXS models. Seat width 10.5".

**Shown with:**

### PASSENGER PILLION – SOFTAIL® SLIM® STYLING

Bring a passenger along for the ride. This easy-to-install detachable Passenger Pillion features a tuck and roll cover styled to match the Original Equipment Softail Slim solo seat. Kit includes mounting hardware and grab strap.

**52400039** **\$139.95**

Fits '12-later FLS models equipped with Original Equipment solo seat. Installation requires separate purchase of Passenger Footpeg Mounting Kit P/N 50932-08 and passenger footpegs. Also fits '11-later FXS models equipped with Tuck & Roll Solo Seat P/N 52000031. Pillion width 6.5".

## F. BRAWLER® SOLO SEAT

When it's time to go it alone, go solo in style. These premium quality saddles are designed to create a subtle and distinctive look. Top-grain leather or vinyl seating surface and contoured foam padding add long-haul comfort and the durable hand-laid fiberglass seat pan is carpeted to protect the paint finish.

Fits '07-later FLSTF, FLSTFB, FLSTSB and '06-later FXST, FXSTB, FXSTC and FXSTS (except FLSTSE/2/3 and FXSTSSE/2/3) models. For two-up versatility, you can add the matching detachable Brawler® Passenger Pillion P/N 52270-08. Seat width 12.5".

**51393-06A** Leather. **\$349.95**

**52269-08** Vinyl. **\$229.95**

Fits '00-'07 FLSTC, '06 FLST, '00-'06 FLSTF and '00-'05 FX Softail models (except FXSTD). Seat width 13.0".

**53359-02** Leather. **\$349.95**



E. TUCK & ROLL SOLO SEAT (SHOWN WITH SOFTAIL SLIM PILLION)



F. BRAWLER SOLO SEAT

Notice: The prices appearing in this catalog are the manufacturer's suggested retail prices. Actual retail prices may vary.

## 228 SOFTAIL®

Seating – Two-Up

### A. RALLYRUNNER® SEAT

This Rallyrunner® Seat combines a sleek frame-hugging contour with added long-haul comfort. The seat features thicker padding for the rider and a wider passenger pillion for the passenger. The premium cowhide leather seating surface has a rich, luxurious feel and the carpeted hand-laid fiberglass seat base hugs the fender for a custom look. The foam padding will form to the rider's shape and provide hours of riding comfort.

**51936-08** **\$399.95**

Fits '07-later FLSTB, FLSTF, FLSTFB and '06-later FXST, FXSTB, FXSTC and FXSTS (except FLSTSE/2/3 and FXSTSSE/2/3) models. FLSTSB models require separate purchase of Passenger Footpeg Mounting Kit P/N 50932-08 and passenger footpegs. Seat width 13.0"; passenger pillion width 11.0".



A. RALLYRUNNER SEAT

### B. SIDEKICK® SEAT

Share your custom ride. The two-up design of this premium cowhide seat offers a frame-hugging look, but adds back support for the rider and additional padding for the passenger. The custom seating surface and the hand-laid fiberglass seat base show attention to detail second to none.

**51387-06A** **\$399.95**

Fits '07-later FLSTF, FLSTFB, FLSTSB and '06-later FXST, FXSTB, FXSTC and FXSTS (except FLSTSE/2/3 and FXSTSSE/2/3) models. FLSTSB models require separate purchase of Passenger Footpeg Mounting Kit P/N 50932-08 and passenger footpegs. Seat width 12.5"; passenger pillion width 6.5".



B. SIDEKICK SEAT

### C. BADLANDER® SEAT

Clean smooth covers, subtle top-stitching and a frame-hugging profile add up to a statement only Harley could create. The low, lean look also offers the benefit of a reduced seat height, ideal for riders wanting the lowest possible seat height. Includes all mounting hardware.

**51397-06A** **\$279.95**

Fits '07-later FLSTF, FLSTFB, FLSTSB and '06-later FXST, FXSTB, FXSTC and FXSTS models (except FLSTSE/2/3 and FXSTSSE3). FLSTSB models require separate purchase of Passenger Footpeg Mounting Kit P/N 50932-08 and passenger footpegs. Seat width 12.0"; passenger pillion width 6.5".

**52292-00A** **\$279.95**

Fits '00-later FLST (except FLSTSE/2/3), FLSTC, FLSTNSE, FLSTSC, '00-'06 FLSTF, '00-'05 FX Softail models (except FXSTD). Also fits FLSTN and FLSTNSE models with removal of stock luggage rack. Seat features embroidered Harley-Davidson script logo. Seat width 12.0"; passenger pillion width 6.5".

**52292-94B** **\$279.95**

Fits '84-'99 Softail® models (except FLSTS). Seat features embroidered Harley-Davidson script logo. Seat width 12.0"; passenger pillion width 6.5".



C. BADLANDER SEAT (51397-06A SHOWN)

NOTE: Some Harley-Davidson® seats are made of leather. Fine leathers or other natural materials WILL gain "character," such as wrinkles or wear, with age. This is normal. A fine, aged patina and character wrinkles are a sign of the extremely high quality materials used to construct your seat or backrest. The appearance of scars or marks on the leather are a result of using natural leather panels and should not be thought of as an imperfection. Please use Harley-Davidson Leather Protectant P/N 93600034 to protect your investment.

Notice: The prices appearing in this catalog are the manufacturer's suggested retail prices. Actual retail prices may vary.



## SOFTAIL® 229

Seating – Road Zeppelin®

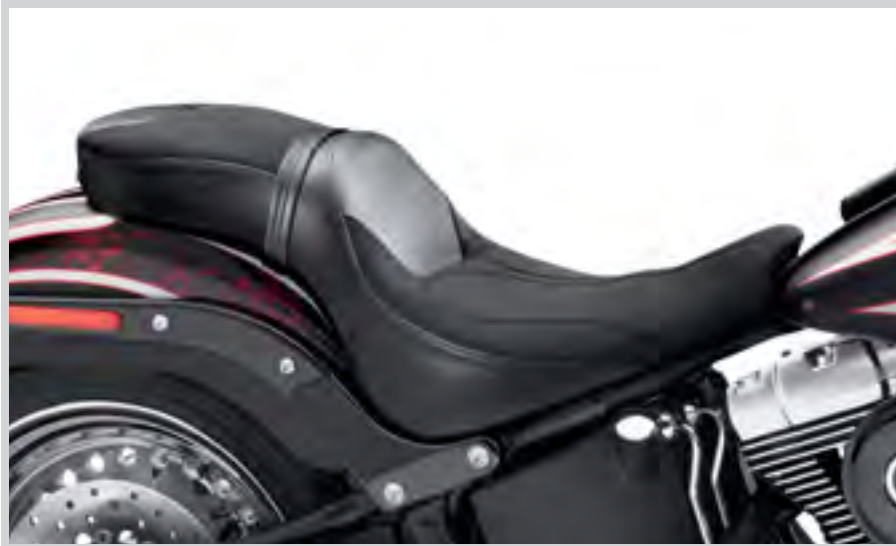

**D. ROAD ZEPPELIN AIR ADJUSTABLE SEAT**

### D. ROAD ZEPPELIN® AIR ADJUSTABLE SEAT

The mating of comfort and style. Low-profile Road Zeppelin® Seats are equipped with a unique adjustable air bladder system that distributes your weight across the seating surface. The air bladder system removes pressure points and provides shock absorption for the rider's and passenger's tailbone. You get hours of riding comfort, without sacrificing the low-slung custom look. The combination of smooth vinyl and water-proof textured fabric seating surfaces allows air to circulate beneath the body, reducing the air temperature between the rider and seat. The easy-to-reach integrated hand pumps and air release valves permit quick and convenient adjustment for both the rider and passenger.

**52000148** **\$599.95**

Fits '07-later FLSTF, FLSTFB and '06-later FXST, FXSTB, FXSTC and FXSTS models. Models not equipped with passenger pegs require separate purchase of Passenger Footpegs and Passenger Footpeg Mounting Kit P/N 50932-08. Seat width 13.5", passenger pillion width 11.0".

**52000149** **\$599.95**

Fits '00-later FLST, FLSTC and FLSTSC. Seat width 13.5", passenger pillion width 11.0".

**52000150** **\$599.95**

Fits '05-later FLSTN models. Seat width 14.5", passenger pillion width 11.5".

### E. ROAD ZEPPELIN SEAT PADS

Experience ultimate comfort. Road Zeppelin® Seat Pads are equipped with a unique air bladder system that allows your weight to be distributed evenly across the entire seating surface, ensuring hours of comfort for both rider and passenger. The air bladder system is designed to remove pressure points and provide shock absorption to reduce vibration. The mesh cover allows air to circulate beneath the rider's body, reducing the air temperature between the rider and seat. The easy-to-reach integrated hand pump and air release valve permits quick and convenient adjustment. Shaped to conform to most Harley-Davidson® seats, the pads feature an adjustable mounting strap and a non-skid surface to keep them in place.

**52000084** Rider. **\$129.95**

Fits rider position on all models equipped with Original Equipment or accessory seats. Also fits passenger position on Touring models with large pillion area. Pad width – 14".0.

**52400060** Passenger Pillion. **\$129.95**

Fits Original Equipment and accessory passenger pillions. Pad length – 11.0"; width – 8.0".



**D. ROAD ZEPPELIN AIR ADJUSTABLE SEAT**



**E. ROAD ZEPPELIN SEAT PADS**

NOTE: Some Harley-Davidson seats are made of leather. Fine leathers or other natural materials WILL gain "character," such as wrinkles or wear, with age. This is normal. A fine, aged patina and character wrinkles are a sign of the extremely high quality materials used to construct your seat or backrest. The appearance of scars or marks on the leather are a result of using natural leather panels and should not be thought of as an imperfection. Please use Harley-Davidson Leather Protectant P/N 93600034 to protect your investment.

Notice: The prices appearing in this catalog are the manufacturer's suggested retail prices. Actual retail prices may vary.

## 230 SOFTAIL®

Seating – Reduced Reach®

### REDUCED REACH® SEATS

Designed to position riders with a shorter inseam closer to the ground, Reduced Reach® Seats are shaped to place the rider in a comfortable and confident relationship to the hand and foot controls. The wide seating surface provides loads of support while riding and the narrow tapered nose brings your legs together for an easier reach to the ground at a stop. Reduced Reach Seats feature a stepped profile that provides back support and keeps the rider from sliding back during acceleration.

#### A. REDUCED REACH SEAT

Designed specifically for riders requiring a close to the bar riding position, this seat positions the rider approximately 1.0" forward and the narrow front profile brings your legs closer together to help you plant your feet firmly on the ground. The seat features a textured vinyl insert and a Bar & Shield logo that shows you are riding in style.

**52442-04A** **\$349.95**

Fits '00-later FLST, FLSTC, FLSTNSE and FLSTSC, '00-'06 FLSTF, '00-'05 FX Softail® models (except FXSTD). Also fits FLSTN models with removal of stock luggage rack. Seat width 13.5"; passenger pillion width 10.0".

**51470-06A** **\$349.95**

Fits '07-later FLSTF, FLSTFB, FLSTSB and '06-later FXST, FXSTB, FXSTC and FXSTS models (except FLSTSE/2/3 and FXSTSSE3). FLSTSB models require separate purchase of Passenger Footpeg Mounting Kit P/N 50932-08 and passenger footpegs. Seat width 13.5"; passenger pillion width 10.0".

#### B. REDUCED REACH SEAT – SOFTAIL® DELUXE

With traditional stitching and a textured valance, this Reduced Reach Seat is styled to complement the Softail Deluxe model. Designed to move riders with shorter inseams closer to the controls, this Reduced Reach Seat positions the rider forward .5" and brings the legs 1.25" closer together to help get your feet planted on the pavement when stopped or parking the bike.

**51762-06** **\$369.95**

Fits '05-later FLSTN. Seat width 15.5"; passenger pillion width 11".

#### C. REDUCED REACH SEAT – BLACKLINE® & SLIM®

The Reduced Reach forward position seat is designed to move riders 1.25" closer to the hand and foot controls. The scooped bucket-shape saddle provides a wide seating surface and added back support for long-range touring, while the narrow tapered front profile brings your legs 1.0" closer together to help your feet rest firmly on the pavement when stopped.

**52000012** **\$349.95**

Fits '11-'13 FXS and '12-later FLS models. Installation requires separate purchase of Passenger Footpeg Mounting Kit P/N 50932-08 and passenger footpegs. Seat width 13.5"; passenger pillion width 9.5".

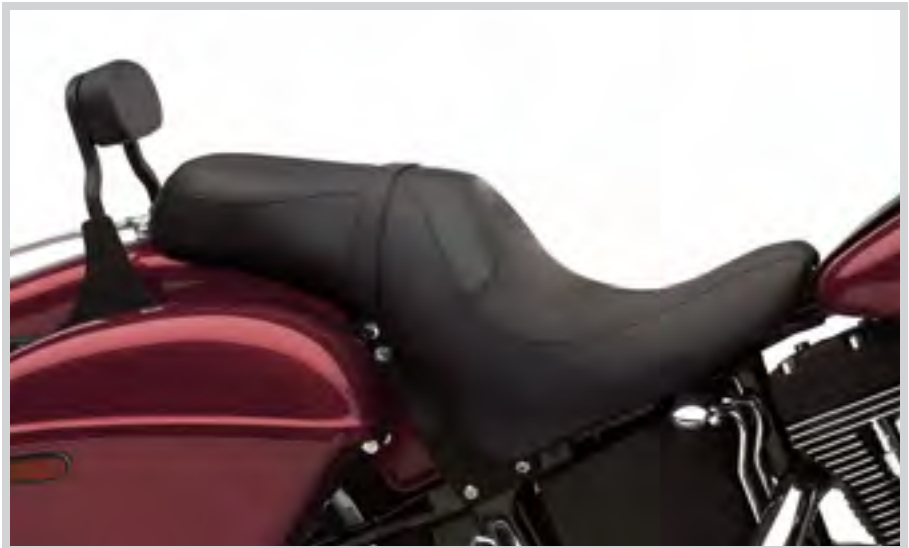

A. REDUCED REACH SEAT



B. REDUCED REACH SEAT – SOFTAIL DELUXE



C. REDUCED REACH SEAT – BLACKLINE & SLIM

*Notice: The prices appearing in this catalog are the manufacturer's suggested retail prices. Actual retail prices may vary.*



## SOFTAIL® 231

Seating – Reduced Reach® & Tallboy®



**D. REDUCED REACH SOLO SEAT – FXSB SOFTAIL**

### **D. REDUCED REACH® SOLO SEAT – FXSB SOFTAIL®**

Designed to position riders with a shorter inseam closer to the ground, Reduced Reach® Seats are shaped to place the rider in a comfortable and confident relationship to the hand and foot controls. The wide seating surface provides loads of support while riding and the narrow tapered nose brings your legs together for an easier reach to the ground at a stop. Reduced Reach Seats feature a stepped profile that provides back support and keeps the rider from sliding back during acceleration. This Reduced Reach Solo Seat is styled to match the Softail® Breakout® model's Original Equipment seat and features a textured vinyl inlay and Harley-Davidson® medallion insert. The seating surface complements the Original Equipment passenger pillion.

**52000099** **\$249.95**  
Fits '13-later FXSB and FXSBSE models. Seat width 14.5".

### **E. SUPER REDUCED REACH SOLO SEAT**

Get a little bit closer. Super Reduced Reach forward position seats are designed to move riders with a shorter inseam even closer to the controls and to bring the legs about 1.0" closer together so that your feet rest firmly on the pavement. The scooped bucket-shape saddle is enhanced with added back support padding to move the rider up to 1.0" lower and 2.5" forward. The combination positions the rider closer to the hand and foot controls to offer both comfort and confidence. For a two-up ride, combine the solo seat with the Touring Passenger Pillion P/N 51898-05A (sold separately).

**54380-11** **\$249.95**  
Fits '00-later FLST and FLSTSC, '05-later FLSTN and FLSTNSE models and '07-later FLSTC models. Seat width 12.0".

**54381-11** **\$249.95**  
Fits '07-later FLSTF and FLSTFB models. Seat width 12.0".

### **F. TALLBOY® SEAT**

The correct riding position can help a tall rider sit comfortably on the bike and avoid leg cramps and back strain during a long day in the saddle. For riders with a longer inseam, a Tallboy® Seat will put you on the road to fatigue-free riding. Designed to move the rider up and back from the stock seating position, a Tallboy Seat can eliminate the "knees-high" riding position and effectively places the body for a natural arm and leg reach to the controls. Tallboy Seats feature a bucket-shaped design for added support and a wide seating surface to reduce pressure on the tailbone. This Tallboy Seat moves the rider back 2.0" and up 3.0" as compared to the Original Equipment seat. The new position allows additional leg and arm movement for the long-limbed rider and a comfortable seating space for the open road. The Tallboy Seat features a smooth vinyl surface that complements many motorcycle models and a wide pillion for added passenger comfort.

**51469-06A** **\$349.95**  
Fits '07-later FLSTF, FLSTFB, FLSTSB and '06-later FXST, FXSTB, FXSTC and FXSTS models (except FLSTSE/2/3 and FXSTSSE3). FLSTSB models require separate purchase of Passenger Footpeg Mounting Kit P/N 50392-08 and passenger footpegs. Seat width 16.5"; passenger pillion width 12.5".



**E. SUPER REDUCED REACH SOLO SEAT  
(SHOWN WITH ORIGINAL EQUIPMENT PASSENGER PILLION)**



**F. TALLBOY SEAT**

SOFTAIL

*Notice: The prices appearing in this catalog are the manufacturer's suggested retail prices. Actual retail prices may vary.*

## 232 SOFTAIL®

Seating – Sundowner™

### SUNDOWNER™ SEATS

The Sundowner™ Seat provides the maximum in long-riding comfort. The deep-bucket design puts your body in the proper touring position and the generous padding makes it comfortable for both the rider and passenger as the miles are adding up. The dished shape back provides added rider back support and the wide passenger pillion is shaped to minimize pressure points.

#### A. SUNDOWNER SEAT – SMOOTH

The smooth vinyl cover features elegant top-stitching to complement most Harley-Davidson® saddlebags and luggage.

**51468-06A** **\$349.95**

Fits '07-later FLSTF, FLSTFB, FLSTSB and '06-later FXST, FXSTB, FXSTC and FXSTS models (except FLSTSE/2/3 and FXSTSSE3). FLSTSB models require separate purchase of Passenger Footpeg Mounting Kit P/N 50932-08 and passenger footpegs. Seat width 16.5"; passenger pillion width 12.5".

**51764-06** **\$349.95**

Fits '00-later FLST, FLSTC, FLSTNSE, FLSTSC, '00-'06 FLSTF and '00-'05 FX Softail® models (except FXSTD). Also fits FLSTN models with removal of stock luggage rack. Seat width 16.5"; passenger pillion width 12.5".

**52000011** **\$349.95**

Fits '11-'13 FXS and '12-later FLS models. Installation requires separate purchase of Passenger Footpeg Mounting Kit P/N 50932-08 and passenger footpegs. Seat width 15.5"; passenger pillion width 12.0".

#### B. SUNDOWNER SEAT – SOFTAIL® DELUXE MODELS

Styled to complement the Softail Deluxe model, this Sundowner Seat features a leather valance with an embossed pattern and winged logo.

**51841-06** **\$379.95**

Fits '05-later FLSTN and FLSTNSE models. Seat width: 16.5"; passenger pillion width: 12.5".

#### C. SUNDOWNER SEAT – HERITAGE SOFTAIL® CLASSIC MODELS

This highly stylized seat features a leather valance with decorative chrome spots, along with intricate stitching detail on the seating surface to match the '00-later Heritage Softail® Classic model.

**51813-09** **\$379.95**

Fits '00-later FLST, FLSTC, FLSTSC, '00-'06 FLSTF and '00-'05 FX Softail models (except FXSTD). Also fits FLSTN and FLSTNSE models with removal of stock luggage rack. Seat width 16.5"; passenger pillion width 12.5".



A. SUNDOWNER SEAT – SMOOTH (51468-06A SOFTAIL SHOWN)



B. SUNDOWNER SEAT – SOFTAIL DELUXE MODELS

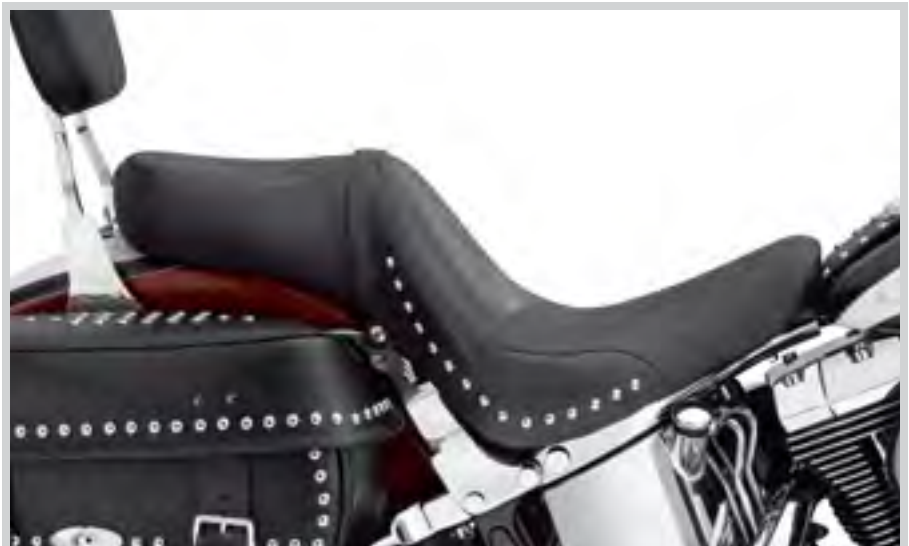

C. SUNDOWNER SEAT – HERITAGE SOFTAIL CLASSIC MODELS

*Notice: The prices appearing in this catalog are the manufacturer's suggested retail prices. Actual retail prices may vary.*



# SOFTAIL® 233

Seating – Sundowner™



**D. SUNDOWNER SEAT – '07-'11 FAT BOY STYLING**

## **D. SUNDOWNER™ SEAT – '07-'11 FAT BOY® STYLING**

This highly stylized seat features an embossed leather valance with 3 decorative chrome studs and Spanish lacing to match the '07-'11 Fat Boy® model.

**51801-07** **\$379.95**

Fits '07-later FLSTF, FLSTFB, FLSTSB and '06-later FXST, FXSTB, FXSTC and FXSTS models (except FLSTSE/2/3 and FXSTSSE3). Also fits FLSTSE models with removal of stock rear fender trim strips. FLSTSB models require separate purchase of Passenger Footpeg Mounting Kit P/N 50932-08 and passenger footpegs. Seat width 16.5"; passenger pillion width 12.5".

## **E. SUNDOWNER SEAT – '00-'06 FAT BOY STYLING**

This highly stylized seat features an embroidered Fat Boy logo and chrome grommets with leather lacing to match the '00-'06 Fat Boy model.

**51570-00A** **\$379.95**

Fits '00-later FLST (except FLSTSE/2/3), FLSTC, FLSTNSE, FLSTSC, '00-'06 FLSTF and '00-'05 FX Softail® (except FXSTD). Also fits FLSTN models with removal of stock luggage rack. Seat width 16.5"; passenger pillion width 12.5".

## **F. SUNDOWNER SEAT – SOFTAIL® DEUCE™ MODELS**

This Sundowner™ Seat gives you added touring comfort without sacrificing the Deuce™ style that has heads turning. Styled to match the Softail Deuce with an embroidered "H-D" logo.

**51112-00B** **\$379.95**

Fits '00-'07 FXSTD models. Seat width 14.0"; passenger pillion width 11.0".



**E. SUNDOWNER SEAT – '00-'06 FAT BOY STYLING**



**F. SUNDOWNER SEAT – SOFTAIL DEUCE MODELS**

SOFTAIL

*Notice: The prices appearing in this catalog are the manufacturer's suggested retail prices. Actual retail prices may vary.*

## 234 SOFTAIL®

Seating – Sundowner™

### A. SUNDOWNER™ – BLACKLINE® & SLIM®

The Sundowner™ Seat provides the maximum in long-riding comfort. The deep-bucket design puts your body in the proper touring position and the generous padding makes it comfortable for both the rider and passenger as the miles are adding up. The dished shape provides added rider back support and the wide passenger pillion is shaped to minimize pressure points. The smooth vinyl cover features elegant top-stitching to complement most Harley-Davidson® saddlebags and luggage.

**52000011** **\$349.95**

Fits '11-'13 FXS and '12-later FLS models. Installation requires separate purchase of Passenger Footpeg Mounting Kit P/N 50932-08 and passenger footpegs. Seat width 15.5"; passenger pillion width 12.0".



A. SUNDOWNER SEAT – BLACKLINE & SLIM

### B. SUNDOWNER SOLO SEAT – FXSB SOFTAIL®

The Sundowner Seat provides the maximum in long-riding comfort. The deep-bucket design puts your body in the proper touring position and the generous padding makes it comfortable as the miles are adding up. The dished shape provides added rider back support and the wide profile is shaped to minimize pressure points. This Sundowner Solo Seat is styled to match the Softail Breakout® model's Original Equipment seat and features a textured vinyl inlay and Harley-Davidson medallion insert. For a two-up ride, combine the solo seat with the matching Sundowner Passenger Pillion P/N 52400066 (sold separately).

**52000098** **\$249.95**

Fits '13-later FXSB and FXSBSE models. Seat width 16.0".



B. SUNDOWNER SOLO SEAT – FXSB SOFTAIL

### C. SUNDOWNER PASSENGER PILLION – FXSB SOFTAIL

Bring a passenger along for the ride. This easy-to-install detachable Passenger Pillion is styled to complement the Sundowner Solo Seat P/N 52000098. Includes grab strap.

**52400066** **\$179.95**

Fits '13-later FXSB and FXSBSE models equipped with Sundowner Solo Seat P/N 52000098. Pillion width 12".



C. SUNDOWNER PASSENGER PILLION – FXSB SOFTAIL

*Notice: The prices appearing in this catalog are the manufacturer's suggested retail prices. Actual retail prices may vary.*



# SOFTAIL® 235

Seating – Signature Series®

## D. SIGNATURE SERIES® SEAT WITH RIDER BACKREST

A perfect combination of foam density and shape has created our most comfortable seat for long-haul touring. Both rider and passenger will be extra comfy riding to Sturgis and back with the wide seating areas. When you reach your destination, city driving will be easier with the narrow nose that helps keep your legs together. Seat features an easily removable adjustable rider backrest that folds down for easier passenger mounting. Rider backrest has a 5-position height adjustment with 1.5" range and a wide range of forward/back angle adjustment with a quick twist of the control knob.

**51985-08** Smooth. **\$539.95**

Fits '07-later FLSTF, FLSTFB, FLSTSB and '06-later FXST, FXSTB, FXSTC and FXSTS models (except FLSTSE/2/3 and FXSTSSE3). FLSTSB models require separate purchase of Passenger Footpeg Mounting Kit P/N 50932-08 and passenger footpegs. Seat width 16.0"; passenger pillion width 14.0".

**51998-08** Smooth. **\$539.95**

Fits '00-later FLST, FLSTC, FLSTNSE, FLSTSC, '00-'06 FLSTF and '00-'05 Softail® models (except FXSTD). Also fits FLSTN models with removal of stock luggage rack. '00-'06 FLST, FLSTC, FLSTSC, FLSTF and '00-'05 FX Softail models require separate purchase of Seat Bracket P/N 51949-09. Seat width 16.0"; passenger pillion width 14.0".

**51922-09** FLSTC Styling with Studs. **\$549.95**

Fits '00-later FLST, FLSTC, FLSTNSE, FLSTSC, '00-'06 FLSTF and '00-'05 Softail models (except FXSTD). Also fits FLSTN models with removal of stock luggage rack. '00-'06 FLST, FLSTC, FLSTSC, FLSTF and '00-'05 FX Softail models require separate purchase of Seat Bracket P/N 51949-09. Seat width 16.0"; passenger pillion width 14.0".

**54397-11** Deluxe Styling with Valance. **\$549.95**

Fits '05-later FLSTN models. Seat width 16.0"; passenger pillion width 14.0".



D. SIGNATURE SERIES SEAT WITH RIDER BACKREST – SMOOTH



D. SIGNATURE SERIES SEAT WITH RIDER BACKREST – FLSTC STYLING



D. SIGNATURE SERIES SEAT WITH RIDER BACKREST – DELUXE STYLING

SOFTAIL

Notice: The prices appearing in this catalog are the manufacturer's suggested retail prices. Actual retail prices may vary.

## 236 SOFTAIL®

Seating – Passenger Pillion

### A. TOURING PASSENGER PILLIONS\*

Styled to match the stitching and texture of the Original Equipment rider seat, these stylish pillions provide an extra comfortable ride for your passenger on those long journeys.

**51898-05A** Smooth Styling. **\$164.95**  
Fits '07-later FLSTC, FLSTF, FLSTFB and '05-'07 FLST and FLSTSC models. Pillion width 14.0".

**52915-07** '07-'11 Fat Boy® Styling. **\$189.95**  
Fits '07-later FLSTC, FLSTF, FLSTFB and '05-'07 FLST and FLSTSC models. Pillion width 14.0".

**52930-05** Softail® Deluxe Styling. **\$184.95**  
Fits '05-later FLSTC and FLSTNSE models with Original Equipment Solo Seat. Pillion width 12.0".

**51763-07** Heritage Softail® Classic Styling. **\$189.95**  
Fits '07-later FLSTC, FLSTF, FLSTFB and '05-'07 FLST and FLSTSC models. Pillion width 14.0".

**52912-00** Heritage Softail Classic Styling. **\$189.95**  
Fits '84-'06 Softail models (except FXSTD, FLSTS, FLSTSC, FLSTN or '05 FLSTFI 15th Anniversary models). Pillion width 14.0".

### B. PASSENGER PILLION – CROSS BONES® STYLING\*

Bring a passenger along for the ride. This easy-to-install detachable Passenger Pillion features insert panels and decorative lacing styled to match the Softail Cross Bones® Original Equipment sprung solo seat. Kit includes mounting hardware and grab strap.

**51787-08** **\$189.95**  
Fits '08-'11 FLSTSB models equipped with Original Equipment solo seat. Installation requires separate purchase of Passenger Footpeg Mounting Kit P/N 50932-08 and passenger footpegs. Pillion width 8.0".

### C. BRAWLER® PASSENGER PILLION\*

Add two-up versatility to your custom ride. Designed to complement leather or vinyl-covered Brawler® solo seats, this easy-to-install vinyl Passenger Pillion allows you to share your ride at a moment's notice. Kit includes mounting hardware and grab strap.

**52270-08** **\$149.95**  
Fits Softail models equipped with Brawler Solo Seat P/N 52269-08 or 51393-06A. Pillion width 9.0".



A. TOURING PASSENGER PILLION – SMOOTH STYLING



A. TOURING PASSENGER PILLION – FAT BOY STYLING

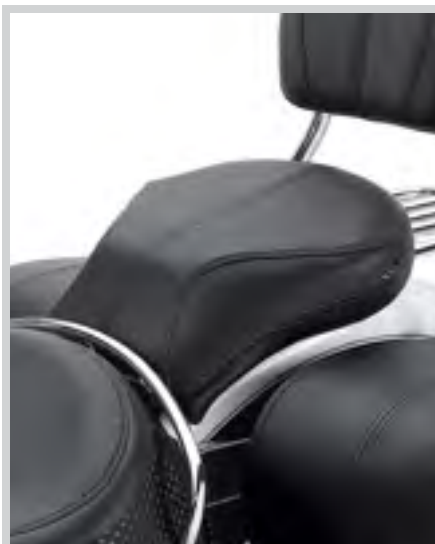

A. TOURING PASSENGER PILLION – SOFTAIL DELUXE STYLING



A. TOURING PASSENGER PILLION – HERITAGE SOFTAIL CLASSIC STYLING



B. PASSENGER PILLION – CROSS BONES STYLING



C. BRAWLER PASSENGER PILLION



**\*WARNING:** Do not install on models that are not equipped with passenger footpegs. Doing so could result in death or serious injury.

Notice: The prices appearing in this catalog are the manufacturer's suggested retail prices. Actual retail prices may vary.



# SOFTAIL® 237

## Seating Accessories



**D. REAR FENDER BIB – SOFTAIL DELUXE MODELS**



**E. REAR FENDER BIB – FAT BOY MODELS**

### D. REAR FENDER BIB – SOFTAIL® DELUXE MODELS

Enhance the nostalgic solo look by replacing the Softail® Deluxe model's Original Equipment passenger pillion and luggage rack with this decorative fender cover. Form-fitted to hug the contour of the rear fender, this decorative fender cover hides the passenger pillion and luggage rack mounting holes that are exposed when riding with a solo seat. Styled to match the Original Equipment solo seat, the Fender Bib features a textured leather insert to complete the nostalgic look. The molded base is finished with a soft felt underliner designed to protect the fender's painted surface.

**52018-08** **\$69.95**

Fits '05-later FLSTN models equipped with Original Equipment rider seat.

### E. REAR FENDER BIB – FAT BOY MODELS

Complete the stripped-down solo look by replacing the Fat Boy model's Original Equipment passenger pillion with this decorative fender cover. Form-fitted to hug the contour of the rear fender, this decorative fender cover hides the passenger pillion mounting holes that are exposed when riding with a solo seat. Styled to match the Original Equipment solo seat, the Fender Bib features a textured leather insert to complete the custom look. The molded base is finished with a soft felt underliner designed to protect the fender's painted surface.

**52038-08** **\$69.95**

Fits '07-later FLSTF and FLSTFB models equipped with Original Equipment rider seat.

### F. CIRCULATOR SEAT AND BACKREST PADS

Keep comfortable on your next long ride. These breathable Circulator Pads feature 3-D construction that promotes air movement and reduces heat build-up where the rider's body touches the seat or backrest. Designed to keep the rider cool by reducing the perspiration build-up between you and the seating surface, the Circulator Pad can be installed and removed in seconds for easy cleaning. The low-profile design minimizes seat-height change compared to inflatable pads, while enhancing comfort with its shock-absorbing construction. Manufactured of UV-stable materials, these seat pads resist fading when exposed to the sun. Elastic under-seat strap and non-slip base provide secure installation and the available Circulator Passenger Pillion Pad attaches to the rider pad with hook-and-loop tabs.

**51076-10** Large Seat Pad. **\$89.95**

Fits Softail, Touring and Trike models with Original Equipment and accessory seats. Will not fit Spring seats and Road Zeppelin® seats. Pad width – 16.0".

**51078-10** Passenger Pillion Pad. **\$69.95**

Fits Original Equipment and accessory passenger pillions. Pad width – 13.0".

**52300103** Wide Backrest Pad. **\$59.95**

Fits wide profile rider and passenger backrest pads up to 12.0" wide and 9.0" tall.



**F. CIRCULATOR SEAT AND WIDE BACKREST PADS**

### G. PASSENGER GRAB RAIL

Add comfort and confidence for your riding companion. Chrome-plated handrail provides a convenient hand grip for your passenger and a secure tie-down point for pillion-mounted touring luggage.

**97031-09** **\$129.95**

Fits '06 FLSTF and '06-later FLST, FLSTC and FLSTSC models.



**G. PASSENGER GRAB RAIL – FLSTC SHOWN**

Notice: The prices appearing in this catalog are the manufacturer's suggested retail prices. Actual retail prices may vary.

# 238 SOFTAIL®

## Seating Accessories

### A. RAIN COVERS\*

Featuring a handy storage sack, this black nylon, water-resistant, Cordura® cover packs easily and shelters your seat from the storm.

**51639-97** Touring Seat. **\$31.95**  
Fits FLSTC, FLSTS and most Touring seats. Does not fit with rider or passenger backrests.

**51638-97** Solo Seat **\$29.95**  
Fits H-D solo seats (except XR and FLSTS).

**51637-97** Two-Up Seat. **\$31.95**  
Fits H-D® Two-Up seats (except XR, FLSTC, FLSTS and seats with rider backrests).

**52952-97** Seat with Rider Backrest (not shown). **\$39.95**  
Fits most seats with rider backrest. Does not fit Trike models.

### B. TANK BRA

This tank bra is made with nonabrasive, fleece-backed vinyl material and features an embroidered Bar & Shield logo. It protects your fuel tank from scratches from keys, belt buckles and other objects. Designed for easy installation and a custom fit without disassembly of the tank or seat.

**57799-00** **\$43.95**  
Fits '93-'03 FXDWG and '00-later Softail® models (except FXCW, FXCWC, FXS, FXSB, FXSTD, FXSTSE, FXSTSSE/2/3, '09-later FLS, FLSTC, FLSTFSE2, FLSTSB, FLSTSE/2/3).

### C. CHROME SCREWS FOR FLST SEAT BRACKET

**94289-94T** **\$9.95**  
Fits '87-'99 FLSTC, FLSTF and FLSTN models.

### D. BILLET SEAT MOUNTING BRACKET – CHROME

The highly stylized design of this bracket adds a stunning look to the back of most seats.

**51804-02** **\$19.95**  
Replaces Bolt-On Seat Brackets P/N 51798-00, 51740-10, 52467-00, 51652-97A and 51652-83B used on most Original Equipment and accessory seats and pillions.

### E. QUICK-RELEASE SEAT HARDWARE KIT

This hardware kit allows the rider to remove one-piece Harley-Davidson® seats quickly and easily.

**51676-97A** **\$19.95**  
Fits '97-later XG, XL, Dyna®, Softail (except FLS models equipped with Original Equipment seat), Touring and Trike models. Does not fit seats equipped with spring-loaded rear seat bracket.

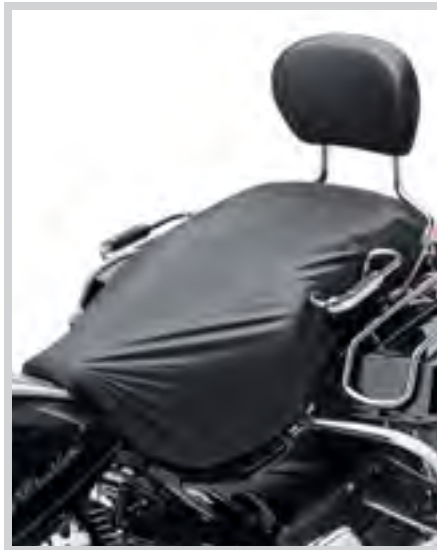

A. RAIN COVER (51639-97 SHOWN)

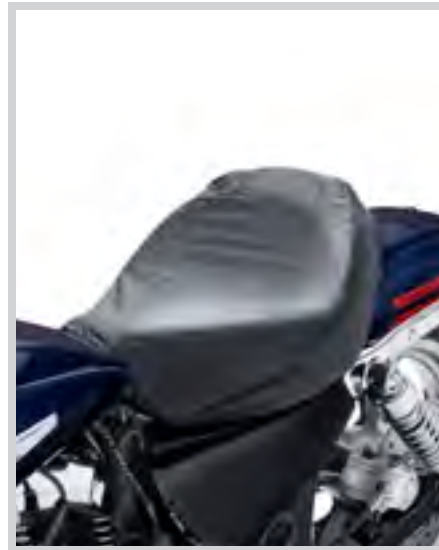

A. RAIN COVER (51638-97 SHOWN)



A. RAIN COVER (51637-97 SHOWN)



B. TANK BRA



C. CHROME SCREWS FOR FLST SEAT BRACKET



D. BILLET SEAT MOUNTING BRACKET – CHROME



E. QUICK-RELEASE SEAT HARDWARE KIT



**\*WARNING:** Do not use while riding; could result in death or serious injury.

Notice: The prices appearing in this catalog are the manufacturer's suggested retail prices. Actual retail prices may vary.



## Choosing a Backrest

A sissy bar upright and passenger backrest are the starting point to build a complete touring machine. The backrest provides long-range comfort and support and adds a feeling of control and confidence for the passenger. For permanent installation, choose rigid sideplates and a style of upright that suits your riding style. For added flexibility, choose a H-D® Detachables™ sideplate kit and appropriate Docking Hardware to make adding or removing a detachable accessory a simple "slide and click" proposition.



### H-D Rigid Sideplates

Fits '00-later FXST, FXSTB, FXSTS, FLSTF, FLSTFB, '05-'06 FLSTN, '06 FLSTFSE2 and '07-later FXSTC and FLSTSB models. '07-later FXSTC models require separate purchase of Fender Mounted seat. '00-'02 models require separate purchase of Hardware Kit P/N 53388-03.

**53378-03A** Chrome. **\$94.95**

Fits '00-later FLSTC, '00-'03 FLSTS, '05-'07 FLSTSC, '06 FLST and '07-later FLSTN models. '00-'02 models require separate purchase of Hardware Kit P/N 53388-03.

**53374-03** Chrome. **\$94.95**



### H-D® Detachables™ Sideplates

Fits '00-later FXST, FXSTB, FXSTS, FXSB, FXSBSE, FXSTSSE/2/3, FLSTFSE2, FLSTSE/2/3, FLST, FLSTF, FLSTFB, FLSTN, FLSTNSE, FLSTSB, FLSTSC models with or without saddlebags (except Heritage Saddlebags P/N 90876-05). Requires separate purchase of Docking Hardware Kit and may require Directional Relocation Kit. See chart for your application.

**53810-00B** Chrome. **\$144.95**

**54258-10** Gloss Black. **\$144.95**

Fits '00-later FLSTC and '00-'03 FLSTS models. Also fits '05-later FLST, FLSTSC models with Heritage Saddlebag P/N 90876-05. Requires separate purchase of Docking Hardware Kit and may require Directional Relocation Kit. See chart for your application.

**53815-00** Chrome. **\$144.95**

Fits '84-'99 Softail® models (except FLSTS). Requires separate purchase of Docking Hardware Kit and may require Directional Relocation Kit. See chart for your application.

**53549-95** Chrome. **\$159.95**



### H-D Adjustable Sideplates

When combined with your choice of Sissy Bar Upright and Backrest Pad, these Premium Adjustable Sideplates allow the passenger to change the recline angle of the passenger backrest for maximum comfort. Simply pull on the release levers and adjust the upright to one of three different recline settings. The exclusive cam lock detachable design lets you to add or remove the passenger backrest assembly in seconds.

Fits '00-later FXSB, FXST, FXSTB, FXSTS, FXSBSE, FXSTSSE/2/3, FLSTFSE2, FLST, FLSTF, FLSTFB, FLSTSB, FLSTSC, FLSTN and FLSTNSE models with or without saddlebags (except Heritage Saddlebags P/N 90876-05). Requires separate purchase of Docking Hardware Kit and may require Directional Relocation Kit.

**53994-11** Chrome. **\$229.95**

**52300003** Gloss Black. **\$229.95**

Fits '00-later FLSTC and '00-'03 FLSTS models. Also fits '05-later FLST, FLSTSC models with Heritage Saddlebag P/N 90876-05. Requires separate purchase of Docking Hardware Kit and may require Directional Relocation Kit.

**52300001** Chrome. **\$229.95**

*Notice: The prices appearing in this catalog are the manufacturer's suggested retail prices. Actual retail prices may vary.*

# 240 SOFTAIL®

Backrests & Racks

## Select a Height



**Standard**

**Standard Sissy Bar Upright**  
Give your passenger additional back support with a Standard Sissy Bar Upright, designed to accept a wide variety of Backrest Pads.



**Low**

**Low Sissy Bar Upright**  
Shaped to complement a thicker passenger pillion, this Low Sissy Bar Upright stands between the Standard and Short Sissy Bar Upright. The ideal match for touring style seats, this upright also offers an additional height option to riders with custom style seats.



**Short**

**Short Sissy Bar Upright**  
This Short Sissy Bar Upright is lower than traditional low uprights and the hidden Backrest Pad Mounting System allows for a sleek look when the pad is removed.

## Select a Style



**Square Bar  
Medallion Style with  
3-Bolt Pad Mount**



**Round Bar  
Mini Medallion Style  
with 3-Bolt Pad Mount**



**Round Bar  
Mini Medallion Style  
with 2-Bolt Pad Mount**

Sissy Bar Uprights are available in a variety of shapes and styles. Square bar uprights feature a traditional plate design that provides a flat surface that is ideal for displaying self-adhesive medallions. Round bar uprights feature a mini medallion bar and an embossed Bar & Shield insert. Uprights are designed to accept specific 3-bolt or 2-bolt mounted backrest pads.

## Select Your Model

Height	Bar	Style	Finish	<i>Fits '84-'05 Softail® models (except FXSTD) and '06-later FL Softail models (except '06 FLSTFSE2, '07-later FLS, FLSTF, FLSTFB, FLTSE/2/3 and FLSTSB) with appropriate sideplates.</i>		<i>Fits '06-later FXST, FXSTB, FXSTS, FLSTFSE2, '07-later FXSTC, FLSTF, FLSTFB, FXSTSSE/2, FLTSE/2/3 and FLSTSB models with appropriate sideplates. '07-later FXSTC models require separate purchase of Fender Mounted Seat.</i>		<i>Fits '13-later FXSB and FXSBSE and '09 FXSTSSE3 models with appropriate H-D® Detachables™ sideplates. FXSTSSE3 models require separate purchase of Hardware Kit P/N 52300306.</i>	
Short	Square	Insert	Chrome	<b>52737-94A</b>	<b>\$74.95</b>	—	—	—	—
Short	Square	Insert	Gloss Black	<b>52706-07</b>	<b>\$74.95</b>	—	—	—	—
Low	Square	Medallion	Chrome	<b>52754-04</b>	<b>\$99.95</b>	—	—	—	—
Low	Square	Medallion	Gloss Black	<b>51851-09</b>	<b>\$99.95</b>	—	—	—	—
Low	Square	Mini Medallion	Chrome	—	—	<b>53282-06</b>	<b>\$89.95</b>	—	—
Low	Round	Mini Medallion	Chrome	<b>52300022</b>	<b>\$99.95</b>	<b>51477-06</b>	<b>\$99.95</b>	<b>52540-09A</b>	<b>\$99.95</b>
Low	Round	Mini Medallion	Gloss Black	<b>52300024</b>	<b>\$99.95</b>	<b>54256-10</b>	<b>\$99.95</b>	—	—
Standard	Square	Medallion	Chrome	<b>52735-85</b>	<b>\$89.95</b>	—	—	—	—
Standard	Square	Mini Medallion	Chrome	—	—	<b>53281-06</b>	<b>\$89.95</b>	—	—
Standard	Square	Mini Medallion	Wrinkle Black	—	—	<b>53407-06</b>	<b>\$89.95</b>	—	—
Standard	Round	Mini Medallion	Chrome	<b>52300018</b>	<b>\$99.95</b>	—	—	—	—
Standard	Round	Mini Medallion	Gloss Black	<b>52300020</b>	<b>\$99.95</b>	—	—	—	—

Notice: The prices appearing in this catalog are the manufacturer's suggested retail prices. Actual retail prices may vary.



# SOFTAIL® 241

Backrests & Racks



Typical H-D® Detachables™ Docking Hardware Kit

## Select the Docking Hardware

### 1984-1999 Softail® Docking Hardware for H-D® Detachables™ Racks & Sideplates

Docking hardware fitment is dependent on vehicle model and saddlebag configuration.

H-D® Detachables™ Accessory	Available to fit:	Docking Hardware		Directional Relocation Kit	
Detachable Sideplates: 53549-95 and Saddlebags: Heritage Style 90835-90C	1984-1999 FLSTC	<b>53371-95B</b>	<b>\$49.95</b>	Not Required	
Detachable Sideplates: 53549-95 and Saddlebags: Fat Boy® 90381-98	1984-1999 FLSTC 1993-1996 FLSTN	<b>53370-95C</b>	<b>\$49.95</b>	Not Required	
Detachable Sideplates 53549-95 and Saddlebags: Fat Boy 90381-98, 90833-90C	1984-1999 FXSTSB, FXSTS, FXSTC, FLSTF	<b>53370-95C</b>	<b>\$49.95</b>	<b>53692-96</b>	<b>\$59.95</b>
Detachable Sideplates: 53549-95 only	1984-1999 FLSTC, FXSTS, FXSTC, FLSTF	<b>53531-95B</b>	<b>\$44.95</b>	Not Required	
Detachable Sideplates: 53549-95 only	1984-1999 FXSTSB	<b>53531-95B</b>	<b>\$44.95</b>	<b>53692-96</b>	<b>\$59.95</b>

### 2000-later Softail Docking Hardware for H-D Detachables Racks, Tour-Pak® Racks & Sideplates

Docking hardware fitment is dependent on vehicle model and saddlebag configuration.

H-D Detachables Accessory	Available to fit:	Docking Hardware		Directional Relocation Kit		
<b>No Saddlebags</b> Detachable Sideplates 53810-00B (Chrome), 53857-00B (Wrinkle Black), 54258-10 (Gloss Black), Adjustable Sideplates 53994-11 (Chrome), 52300003 (Gloss Black), Solo Detach Rack 53649-05 (Chrome), 53612-08, 53652-05 (Black), One-Piece Detach Sissy Bar Upright P/N 53618-05 (Chrome), 52729-08 (Black), FXS One-Piece Sissy Bar P/N 52828-11, 52760-11, Solo Detach Tour-Pak® Rack 53559-04A or Two-Up Detachable Tour-Pak Rack 54051-08, 53066-00C.	2000-2001 FXST, FXSTB, FXSTS, FLSTF	<b>53824-00A</b>	<b>\$44.95</b>	<b>53820-00</b>	<b>\$39.95</b>	
	2002 FXST, FXSTB, FXSTS, FLSTF	<b>53824-00A</b>	<b>\$44.95</b>	<b>53859-02A</b>	<b>\$39.95</b>	
	2003-later FXST, FXSTB, FXSTS, FXSTSSE/2/3, FXSTC, FLSTF, FLSTFB, FLSTFSE2, FLSTSB	<b>53932-03A</b>	<b>\$44.95</b>	<b>53959-06</b> Chrome <b>54268-10</b> Black	<b>\$49.95</b> <b>\$49.95</b>	
	2005-later FLSTN, FLST	<b>53932-03A</b>	<b>\$44.95</b>	Not Required		
	2005-2007 FLSTSC	<b>53932-03A</b>	<b>\$44.95</b>	<b>53959-06</b> Chrome <b>54268-10</b> Black	<b>\$49.95</b> <b>\$49.95</b>	
	2011-later FLS, FXS	<b>53932-03A</b>	<b>\$44.95</b>	<b>54296-11</b>	<b>\$49.95</b>	
<b>With P&amp;A Saddlebags</b> Detachable Sideplates 53810-00B (Chrome), 53857-00B (Wrinkle Black), 54258-10 (Gloss Black), Adjustable Sideplates 53994-11 (Chrome), 52300003 (Gloss Black), Solo Detach Rack 53649-05 (Chrome), 53612-08, 53652-05 (Black), One-Piece Detach Sissy Bar Upright P/N 53618-05 (Chrome), 52729-08 (Black), Solo Detach Tour-Pak Rack 53559-04A, Two-Up Detachable Tour-Pak Rack 54051-08, 53066-00C.	2000-2001 FXST, FXSTB, FXSTS, FLSTF	<b>53821-00A</b>	<b>\$44.95</b>	<b>53820-00</b>	<b>\$39.95</b>	
	2002 FXST, FXSTB, FXSTS, FLSTF	<b>53821-00A</b>	<b>\$44.95</b>	<b>53859-02A</b>	<b>\$39.95</b>	
	2003-later FXST, FXSTB, FXSTS, FXSTSSE/2, FXSTC, FLSTF, FLSTFB, FLSTFSE2, FLSTSB	<b>53930-03B</b>	<b>\$39.95</b>	<b>53959-06</b> Chrome <b>54268-10</b> Black	<b>\$49.95</b> <b>\$49.95</b>	
	2005-later FLSTN, FLST	<b>53930-03B</b>	<b>\$39.95</b>	Not Required		
	2005-2007 FLSTSC	<b>53930-03B</b>	<b>\$39.95</b>	<b>53959-06</b> Chrome <b>54268-10</b> Black	<b>\$49.95</b> <b>\$49.95</b>	
	2013 FXSB, FXSBSE	<b>52300239</b>	<b>\$44.95</b>	Not Required		
<b>With P&amp;A Saddlebags</b> 53015-05, 53061-00A, 88237-07, 88238-07, 88263-07, 88286-07, 90058-05, 90114-00A, 90119-00A, 90130-00B, 90133-06B, 90200765, 90200784, 90200816, 90320-00B, 90384-04, 90384-06, 90388-04, 90419-08, 91536-00A, 91537-00A, 91555-01A, 92000-00B and 92015-03.	2009 FXSTSSE3	<b>53821-00A</b>	<b>\$44.95</b>	<b>53959-06</b> Chrome <b>54268-10</b> Black	<b>\$49.95</b> <b>\$49.95</b>	
	<b>With Original Equipment Saddlebags</b> Detachable Sideplates 53815-00 (Chrome), Adjustable Sideplates 52300001 (Chrome), Solo Detach Rack 53649-05 (Chrome), 53652-05 (Black), Solo Detach Tour Pak Rack 53559-04A or Two-Up Detachable Tour Pak Rack 54051-08, 53066-00C with Original Equipment Saddlebags or with P&A Saddlebags P/N 90876-05.	2000-2002 FLSTC	<b>53822-00A</b>	<b>\$49.95</b>	Not Required	
		2003-later FLSTC	<b>53931-03A</b>	<b>\$44.95</b>	Not Required	
		2000-2001 FLSTS	<b>53822-00A</b>	<b>\$49.95</b>	<b>53820-00</b>	<b>\$39.95</b>
		2002 FLSTS	<b>53822-00A</b>	<b>\$49.95</b>	<b>53859-02A</b>	<b>\$39.95</b>
		2003 FLSTS	<b>53931-03A</b>	<b>\$44.95</b>	<b>53959-06</b> Chrome <b>54268-10</b> Black	<b>\$49.95</b> <b>\$49.95</b>
2005-2007 FLSTSC		<b>53931-03A</b>	<b>\$44.95</b>	<b>53959-06</b> Chrome <b>54268-10</b> Black	<b>\$49.95</b> <b>\$49.95</b>	
2006 FLST	<b>53931-03A</b>	<b>\$44.95</b>	Not Required			
Detachable Sideplates and Hard Saddlebags 90715-08XX.	2008-later FLSTF, FLSTFB	<b>53930-03B &amp; 53075-03</b>	<b>\$39.95</b> <b>\$29.95</b>	Included with Hard Saddlebags		
Detachable Sideplates and Hard Saddlebags 90725-08XX.	2008-later FLSTN	<b>53930-03B &amp; 53075-03</b>	<b>\$39.95</b> <b>\$29.95</b>	Not Required		

\*See fitment for Saddlebag Kits P/N 88237-07, 88238-07 or 88306-07.

Notice: The prices appearing in this catalog are the manufacturer's suggested retail prices. Actual retail prices may vary.

# 242 SOFTAIL®

## Backrests & Racks

### PASSENGER BACKREST PADS

Choose from a wide variety of backrest pad sizes and shapes to match your comfort and style demands. Designed to complement Original Equipment and accessory seats, these pads are engineered to fit specific sissy bar upright types.

#### A. SHORT BACKREST PAD

Innovative Backrest Pad Mounting System features a brushed stainless steel insert framed with chrome plate and hardware.

**52517-94** **\$59.95**

Fits Short Insert Style Sissy Bar Upright P/N 51513-02, 52737-94A or 52706-07.



**A. SHORT BACKREST PAD**

#### B. BACKREST PADS

Sized to fit medallion and mini medallion-style sissy bar uprights. Pad mounts with single center screw and bolt-on mounting strap. Includes chrome-plated hardware.

Fits Low Medallion Style Sissy Bar Upright P/N 52754-04 or 51851-09, Low Square Bar Mini-Medallion Style Sissy Bar Upright P/N 53282-06, Standard Square Bar Mini Medallion Style Sissy Bar Upright P/N 53281-06 or 53407-06, Standard Medallion Style Sissy Bar Upright P/N 52735-85, 53007-98, 52655-84, 52909-02 or 51517-02, Standard Bar & Shield Style Sissy Bar Upright 52739-83 or 51514-02, Standard Heritage Style Sissy Bar Upright P/N 52731-00 and Low Round Bar Sissy Bar Upright P/N 52300022 or 52300024.

**1. 52652-04** Smooth. **\$69.95**

**2. 52626-04** Smooth Top-Stitched. **\$69.95**



**B. BACKREST PADS**

#### C. BACKREST PADS

Sized to fit round bar sissy bar uprights, these pads mount to mini medallion-style uprights with two mounting holes.

Fits Standard Round Bar Mini-Medallion Style Upright P/N 52877-10 or 51168-10. Also fits Low Round Bar Mini Medallion Style Sissy Bar Upright P/N 52540-09A, 51477-06, 54256-10, 52300049 and 52300050.

**1. 51641-06** Smooth Top-Stitched. **\$69.95**

**2. 51640-06** Smooth Bucket. **\$99.95**

**3. 51622-07** Fat Boy® Lacing Bucket. **\$119.95**

**4. 52300301** CVO™ FXSBSE Style – Black. **\$129.95**

**5. 52300293** CVO FXSBSE Style – Brown. **\$129.95**

**6. 52300336** '14 CVO FXSBSE Style. **\$129.95**



**C. BACKREST PADS**

*Notice: The prices appearing in this catalog are the manufacturer's suggested retail prices. Actual retail prices may vary.*



# SOFTAIL® 243

## Backrests & Racks



**D. BACKREST PADS**

### D. BACKREST PADS

Sized to fit medallion and mini medallion-style sissy bar uprights. Pad mounts with single center screw and bolt-on mounting strap. Kit includes chrome-plated mounting hardware.

Fits Low Medallion Style Sissy Bar Upright P/N 52655-84, 52909-02, 52754-04, 51851-09, Standard Medallion Style Sissy Bar Upright P/N 52735-85 or 52877-08, Standard Square Bar Mini Medallion Style Sissy Bar Upright P/N 53281-06 or 53407-06, Standard Heritage Style Sissy Bar Upright P/N 52731-00 and Standard Round Bar Sissy Bar Upright P/N 52300018 or 52300020.

<b>1. 52612-95</b>	Smooth Top-Stitched.	<b>\$69.95</b>
<b>2. 52412-79A</b>	Embossed Bar & Shield Logo.	<b>\$69.95</b>
<b>3. 52532-90</b>	Fat Boy®.	<b>\$79.95</b>
<b>4. 52348-97</b>	Heritage Classic Bucket.	<b>\$109.95</b>
<b>5. 52347-97</b>	Fat Boy Bucket.	<b>\$99.95</b>
<b>6. 51132-98</b>	Smooth Bucket.	<b>\$99.95</b>

### E. BACKREST PADS

Sized to fit tall medallion and insert-style sissy bar uprights. Pads mount with upper bolt-on mounting strap and two lower mounting clips. Kit includes chrome-plated mounting brackets and hardware.

Fits Tall Medallion Style Sissy Bar Upright P/N 52777-85A, 51519-02 or 52749-85A. Also fits Tall Insert Style Sissy Bar Upright P/N 51518-02 or 53552-81A.

<b>52965-98</b>	Smooth Top-Stitched.	<b>\$79.95</b>
-----------------	----------------------	----------------

### F. PASSENGER BACKREST PAD – BLACKLINE® & SLIM®

Styled to complement the FXS Original Equipment or accessory seats, these compact Backrest Pads are the perfect match for Softail® Blackline® motorcycle.

Fits '11-later FLS and FXS models equipped with Sissy Bar P/N 52760-11 or 52828-11.

<b>1. 52300013</b>	FXS Perforated with grey stitching.	<b>\$69.95</b>
<b>2. 52300038</b>	Smooth.	<b>\$69.95</b>



**E. BACKREST PADS**



**F. PASSENGER BACKREST PAD – BLACKLINE & SLIM**

*Notice: The prices appearing in this catalog are the manufacturer's suggested retail prices. Actual retail prices may vary.*

## 244 SOFTAIL®

Backrests & Racks

### A. ONE-PIECE H-D® DETACHABLES™ TALL SISSY BAR UPRIGHT – GLOSS BLACK

The sweeping shape and gloss black finish of this slim, round bar Sissy Bar Upright complements the classic “bobber” look of the Softail Cross Bones® model. The one-piece design eliminates separate sideplates for a clean appearance and the stylized upper kick angle mimics the old-school sissy bars of the '50s and '60s. Can be used with Passenger Backrest Pad P/N 52631-07.

**52729-08 \$199.95**

Fits '06-later FXST, FXSTB, FXSTC, FXSTS and '07-later FLSTF, FLSTFB, FLSTSB and FLSTSE/2/3 models. Requires separate purchase of Docking Hardware Kit and may require Turn Signal Relocation Kit. See Docking Hardware Fitment Chart for your application.

**Shown with:**

#### PASSENGER BACKREST PAD

Styled to complement available touring and custom seats.

**52631-07 \$69.95**

Fits One-Piece H-D® Detachables™ Sissy Bar Upright P/N 52729-08, 51853-07, 51849-07, 51146-10, 51161-10 52300040, 52300042, 52300044 or 52300046.



**A. ONE-PIECE H-D DETACHABLES TALL SISSY BAR UPRIGHT – GLOSS BLACK (SHOWN WITH PASSENGER BACKREST PAD)**

### B. ONE-PIECE H-D DETACHABLES SISSY BAR UPRIGHT – CHROME

The sweeping shape of this slim, round bar Passenger Upright accents the nostalgic lines of the Softail® Deluxe model and the one-piece design eliminates separate sideplates for a clean design. The chrome Detachable Upright accepts Backrest Pads P/N 53928-05, 51587-05 and 51687-06 and features a stylized Bar & Shield cross-brace.

**53618-05 \$259.95**

Fits '00-'05 FXST, FXSTB, FXSTS, '00-'06 FLSTF (except FLSTFSE2) and '05-later FLST, FLSTN, FLSTNSE and FLSTSC models. Fits with or without saddlebags. Does not fit with Heritage Saddlebags P/N 90876-05. Requires separate purchase of appropriate Docking Hardware Kit and may require Directional Relocation Kit.



**B. ONE-PIECE H-D DETACHABLES SISSY BAR UPRIGHT – CHROME**

### C. SHORT BACKREST PAD FOR SOFTAIL ONE-PIECE UPRIGHT

Styled to complement the Softail Deluxe Original Equipment seat and passenger pillion, this Short Backrest Pad hugs the contour of the one-piece upright.

**53928-05 Softail Deluxe Pattern. \$69.95**

Fits One-Piece Passenger Upright P/N 53618-05.

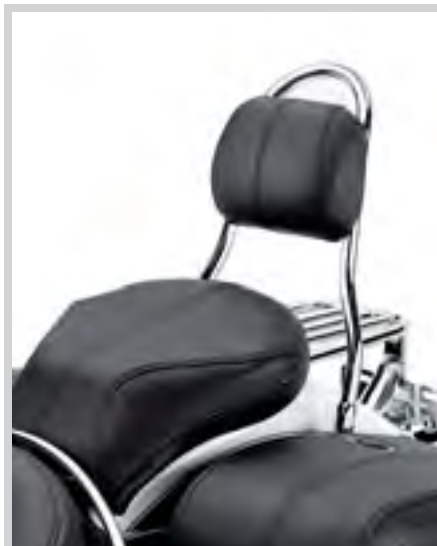

**C. SHORT BACKREST PAD FOR SOFTAIL ONE-PIECE UPRIGHT**

### D. TALL BACKREST PAD FOR SOFTAIL ONE-PIECE UPRIGHT

Styled to complement your Softail model Original Equipment seat and passenger pillion, this Tall Backrest Pad delivers additional passenger support for the run across town or across the country. Combine with a matching Touring Passenger Pillion for maximum comfort.

**51587-05 Softail Deluxe Pattern. \$94.95**

Fits One-Piece Passenger Upright P/N 53618-05.



**D. TALL BACKREST PAD FOR SOFTAIL ONE-PIECE UPRIGHT – SOFTAIL DELUXE PATTERN**

*Notice: The prices appearing in this catalog are the manufacturer's suggested retail prices. Actual retail prices may vary.*



# SOFTAIL® 245

Backrests & Racks

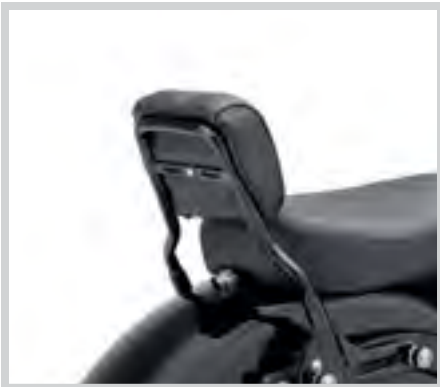

**E. SHORT ONE-PIECE H-D DETACHABLES SISSY BAR – BLACKLINE & SLIM**



**E. STANDARD-HEIGHT ONE-PIECE H-D DETACHABLES SISSY BAR – BLACKLINE & SLIM**



Standard-Height

Tall



**F. SISSY BAR UPRIGHTS – SOFTAIL DEUCE**



**G. SHORT BACKREST PAD – SOFTAIL DEUCE**

**H. TALL BACKREST PAD – SOFTAIL DEUCE**

## E. ONE-PIECE H-D® DETACHABLES™ SISSY BAR – SOFTAIL® BLACKLINE® & SLIM®

Sweeping curves and a sleek gloss black finish add a custom look to this detachable Sissy Bar. Featuring a slotted base and beefy solid bar upright, the one-piece design incorporates exclusive cam lock H-D® Detachables™ hardware that allows you to install or remove the passenger backrest in seconds. Just add your choice of backrest pad to complete the system. Available in your choice of short or standard-height designs.

Fits '11-later FLS and FXS models. Requires separate purchase of appropriate Docking Hardware P/N 53932-03A and Turn Signal Relocation Kit P/N 54296-11. Models equipped with Side-Mount License Plate require Relocation Kit P/N 67900127. Models equipped with a center-mount license plate and fender-mounted reflectors require installation of additional components (sold separately): Red Reflector Kit P/N 67900223 or Amber Reflector Kit P/N 67900224.

<b>52828-11</b>	Short, Gloss Black.	<b>\$259.95</b>
<b>52760-11</b>	Standard-Height, Gloss Black.	<b>\$259.95</b>

### Also available:

#### PASSENGER BACKREST PAD – SOFTAIL BLACKLINE

Styled to complement the FXS Original Equipment or accessory seats, these compact Backrest Pads are the perfect match for Softail® Blackline® motorcycle.

Fits '11-later FLS and FXS models equipped with Sissy Bar P/N 52760-11 or 52828-11.

<b>52300013</b>	FXS Perforated with grey stitching.	<b>\$69.95</b>
<b>52300038</b>	Smooth.	<b>\$69.95</b>

## F. SISSY BAR UPRIGHTS – SOFTAIL DEUCE™

The Deuce™ model was designed to accept this chrome-plated upright without the need for sideplates, providing a clean look. The design allows the upright to be mounted directly to the fender, giving the appearance that the upright comes right out of the seat. Easily removable, the upright offers you an instant option of stock Original Equipment look. Mounting hardware installs in minutes and is hidden from view by a unique cut-out in the passenger pillion base.

Fits '00-'07 FXSTD models.

<b>51114-00</b>	Standard-Height.	<b>\$94.95</b>
<b>51144-02</b>	Tall.	<b>\$104.95</b>

## G. SHORT BACKREST PAD – SOFTAIL DEUCE

Styled to complement the Badlander® and Snakeskin seats for Softail Deuce models.

<b>51534-00</b>		<b>\$69.95</b>
Fits '00-'07 FXSTD models equipped with Sissy Bar Upright P/N 51114-00.		

## H. TALL BACKREST PAD – SOFTAIL DEUCE

This taller backrest pad is designed to give the passenger more back support for the long haul. Works with the Tall Upright P/N 51144-02.

<b>51099-02</b>		<b>\$69.95</b>
Fits '00-'07 FXSTD models equipped with Deuce Tall Upright P/N 51144-02.		

SOFTAIL

Notice: The prices appearing in this catalog are the manufacturer's suggested retail prices. Actual retail prices may vary.

## 246 SOFTAIL®

### Backrests & Racks

#### A. AIR FOIL PREMIUM LUGGAGE RACK\*

The low-profile aerodynamic styling defines the look of this Luggage Rack. Available in mirror-chrome or rich gloss black finish, the die-cast rear "Air Foil" grabs your attention and the Bar & Shield insert adds a signature touch. The elegant round tube rack features inlaid rubber runners for added grip and dedicated bungee mounting points to simplify luggage tie-down. Kit includes all necessary mounting hardware. For added visibility, the rack is designed to incorporate the internal wiring of the Air Foil Rack LED Light Kit P/N 68000076 (red) or 68000077 (smoked) for a clean look.

Fits '04-later XL models equipped with H-D® Detachables™ Sideplates, '06-later Dyna® models (except FXDF, FXDFSE/2 and '10-later FXDWG) equipped with Rigid or Detachable Sideplates, '84-'05 Softail® models (except FXSTD and FLSTN) and '06-later FLST, FLSTC, FLSTNSE and FLSTSC models and '06 FLSTF models equipped with Detachable or Rigid Mount Sideplates.

<b>54290-11</b>	Chrome.	<b>\$209.95</b>
<b>54291-11</b>	Gloss Black.	<b>\$209.95</b>

#### B. AIR WING TWO-UP LUGGAGE RACK\*

The low-profile aerodynamic styling defines the look of this Luggage Rack. Available in mirror-chrome or rich gloss black finish, the rack draws your eye with its sleek lines and the engraved "Harley-Davidson" script adds a signature touch. The die-cast wing and lightweight steel tubing are hand-polished before finishing for long-lasting beauty. Kit includes all necessary mounting hardware. For added visibility, the rack is designed to incorporate the internal wiring of the Air Wing Rack Light Kit P/N 68000005 or 68000006 (sold separately) for a clean look.

Fits '06-later FXST, FXSTB, FXSTS, FLSTFSE2 and '07-later FXSTC, FLSTF, FLSTFB, FLSTSE/2/3, FXSTSSE/2 and FLSTSB models with Rigid or H-D Detachables Sideplates and Sissy Bar Uprights. '07-later FXSTC models require separate purchase of Fender Mounted Seat.

<b>54292-11</b>	Chrome.	<b>\$229.95</b>
<b>50300009</b>	Gloss Black.	<b>\$229.95</b>

#### C. LED LIGHT KIT

This fast-acting LED Light Kit operates as a supplemental rear running light and brake light. The high, center-mount position places the light in the line-of-sight of following vehicles and the bright, fast-acting LED lamps get you noticed. Wiring is concealed inside the rack tubes for a clean, custom installation. Available with red or smoked lens.

Fits Air Foil Luggage Rack P/N 54290-11, 54291-11 and Air Wing Sissy Bar Upright P/N 52300146 and 52300147. Installation requires separate purchase of model-specific Wiring Harness Kit.

<b>68000076</b>	Red Lens.	<b>\$44.95</b>
<b>68000077</b>	Smoked Lens.	<b>\$44.95</b>

Fits Air Wing Luggage Rack P/N 54292-11 and 50300009. Does not fit CVO™ models.

<b>68000005</b>	Red Lens.	<b>\$59.95</b>
<b>68000006</b>	Smoked Lens.	<b>\$59.95</b>

#### Also available:

#### LED LIGHT KIT WIRING HARNESS

Required for installation of LED Light Kit on Air Foil Luggage Rack P/N 54290-11 or 54291-11.

<b>73415-11</b>	<b>\$11.95</b>
-----------------	----------------

Fits '06-later Dyna models (except FXDF, FXDFSE/2, '14-later FXDL and '10-later FXDWG), '84-'05 Softail models (except FXSTD and FLSTN), '06-later FLST, FLSTC and FLSTSC models and '06 FLSTF models with Air Foil Luggage LED Light Kit P/N 68000076 or 68000077.



A. AIR FOIL PREMIUM LUGGAGE RACK – CHROME



A. AIR FOIL PREMIUM LUGGAGE RACK – GLOSS BLACK



B. AIR WING TWO-UP LUGGAGE RACK – CHROME



B. AIR WING TWO-UP LUGGAGE RACK – GLOSS BLACK

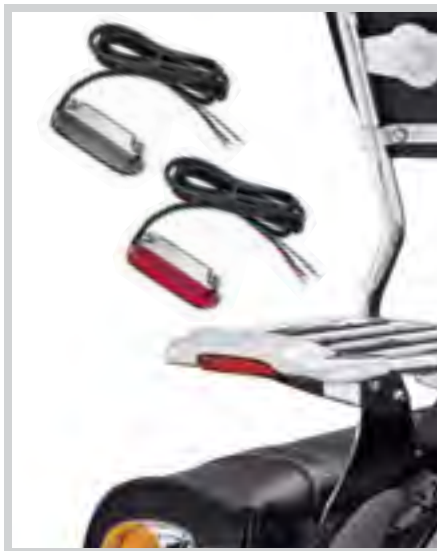

C. LED LIGHT KIT – AIR FOIL RACK



C. LED LIGHT KIT – AIR WING RACK



**\*WARNING:** Do not use this rack as a seat. Do not exceed the fender rack weight capacity. Using as seat or exceeding this capacity could cause handling problems which could result in loss of control and death or serious injury.

Notice: The prices appearing in this catalog are the manufacturer's suggested retail prices. Actual retail prices may vary.



# SOFTAIL® 247

Backrests & Racks



**D. CUSTOM TAPERED SPORT LUGGAGE RACK – CHROME (53953-06 SHOWN)**



**D. CUSTOM TAPERED SPORT LUGGAGE RACK – GLOSS BLACK (54263-10 SHOWN)**



**E. TAPERED LUGGAGE RACK – CHROME (53718-04 SHOWN)**



**E. TAPERED LUGGAGE RACK – GLOSS BLACK (53510-07 SHOWN)**



**E. TAPERED LUGGAGE RACK – CHROME (53896-06 SHOWN)**



**E. TAPERED LUGGAGE RACK – WRINKLE BLACK (53956-06 SHOWN)**



**F. SPORT LUGGAGE RACK – FIVE BAR, CHROME**

## D. CUSTOM TAPERED SPORT LUGGAGE RACK\*

Smooth sweeping curves and the brilliant chrome or gloss black finish define the look of this Sport Luggage Rack. Designed to complement both round and square bar Sissy Bar Uprights, this sleek rack adds a practical and stylish touch to the motorcycle.

Fits '04-later XL models equipped with H-D® Detachables™ Sideplates, '06-later Dyna® models (except FXDF, FXDFSE/2 and '10-later FXDWG) equipped with Rigid or Detachable Sideplates, '84-'05 Softail® models (except FXSTD and FLSTN) and '06-later FLST, FLSTC, FLSTNSE and FLSTSC models and '06 FLSTF models equipped with Detachable or Rigid Mount Sideplates.

<b>50300030</b>	Chrome.	<b>\$139.95</b>
<b>50300031</b>	Gloss Black.	<b>\$139.95</b>

Fits '06-later FXST, FXSTB, FXSTS, FLSTFSE2 and '07-later FXSTC, FLSTF, FLSTFB, FXSTSSE/2, FLSTSE/2/3 and FLSTSB models with Detachable Sideplates or Rigid Mount Sideplates and Sissy Bar Upright. '07-later FXSTC models require separate purchase of Fender Mounted Seat.

<b>53953-06</b>	Chrome.	<b>\$139.95</b>
<b>54263-10</b>	Gloss Black.	<b>\$139.95</b>

Fits '13-later FXSB and FXSBSE and '09 FXSTSSE3 models with Detachable Sideplates and Low Sissy Bar Upright P/N 52540-09A.

<b>50300066A</b>	Chrome.	<b>\$144.95</b>
------------------	---------	-----------------

## E. TAPERED LUGGAGE RACK\*

Styled to enhance the lines of the motorcycle, this sleek, compact Tapered Rack is an elegant solution for carrying your lunch to work or your luggage across the country.

Fits '04-later XL models equipped with H-D Detachables Sideplates, '06-later Dyna models (except FXDF, FXDFSE/2 and '10-later FXDWG) equipped with Rigid or Detachable Sideplates, '84-'05 Softail models (except FXSTD and FLSTN) and '06-later FLST, FLSTC, FLSTNSE and FLSTSC models and '06 FLSTF models equipped with Detachable or Rigid Mount Sideplates.

<b>53718-04</b>	Chrome.	<b>\$119.95</b>
<b>53510-07</b>	Gloss Black.	<b>\$119.95</b>

Fits '06-later FXST, FXSTB, FXSTS, FLSTFSE2 and '07-later FXSTC, FLSTF, FLSTFB, FXSTSSE/2, FLSTSE/2/3 and FLSTSB models with Rigid or Detachable Sideplates and Sissy Bar Uprights. '07-later FXSTC models require separate purchase of Fender Mounted Seat.

<b>53896-06</b>	Chrome.	<b>\$139.95</b>
<b>53956-06</b>	Wrinkle Black.	<b>\$139.95</b>

## F. SPORT LUGGAGE RACK – FIVE BAR\*

This rack brings touring flexibility to your motorcycle. Can be used with H-D Detachables or Rigid Mount Sissy Bar Sideplates.

<b>53862-00</b>	Chrome.	<b>\$139.95</b>
-----------------	---------	-----------------

Fits '04-later XL models equipped with Detachable Sideplates, '06-later Dyna models (except FXDF, FXDFSE/2 and '10-later FXDWG) equipped with Rigid or Detachable Sideplates, '84-'05 Softail models (except FXSTD and FLSTN), '06-later FLST, FLSTC and FLSTSC models and '06 FLSTF models equipped with Detachable or Rigid Mount Sideplates. Does not fit with Round Bar Uprights P/N 52300018, 52300020, 52300022 and 52300024.



**\*WARNING:** Do not use this rack as a seat. Do not exceed the fender rack weight capacity. Using as seat or exceeding this capacity could cause handling problems which could result in loss of control and death or serious injury.

Notice: The prices appearing in this catalog are the manufacturer's suggested retail prices. Actual retail prices may vary.

# 248 SOFTAIL®

Backrests & Racks

## A. H-D® DETACHABLES™ SOLO RACKS\*

Add touring capabilities to your solo seat Softail® model in less than 60 seconds. This detachable Solo Rack fits over the fender when the passenger pillion is removed. The rack features brazed hand-polished tubing and the chrome or black finish adds a stylish flair. Requires Docking Hardware. Easily interchangeable with detachable Passenger Sissy Bar Upright and Sideplates.

Fits '00-'05 Softail models (except Deuce™). Fits '06 FLST, FLSTF and '06-later FLSTC, FLSTN, FLSTSC. Requires solo seat and separate purchase of appropriate Docking Hardware Kit.

<b>53652-05</b>	Gloss Black.	<b>\$199.95</b>
<b>53649-05</b>	Chrome.	<b>\$199.95</b>

Fits '06-later FXST, FXSTB, FXSTC, FXSTS (except FXSTSSE3) and '07-later FLSTF, FLSTFB, FLSTSB and FLSTSE/2/3 models. Requires solo seat and separate purchase of Docking Hardware Kit and Turn Signal Relocation Kit. See Docking Hardware Fitment Chart for your application.

<b>53612-08</b>	Gloss Black.	<b>\$199.95</b>
-----------------	--------------	-----------------

Fits '12-later FLS and '11-'13 FXS models. Requires separate purchase of appropriate Docking Hardware P/N 53932-03A and Turn Signal Relocation Kit P/N 54296-11. Models equipped with Side-Mount License Plate require Relocation Kit P/N 67900127. Models equipped with a center-mount license plate and fender-mounted reflectors require installation of additional components (sold separately): Red Reflector Kit P/N 67900223 or Amber Reflector Kit P/N 67900224.

<b>50300099</b>	Gloss Black.	<b>\$201.95</b>
-----------------	--------------	-----------------

## B. BOBTAIL FENDER RACKS\*

Not only is it functional, but it's a great way to emphasize the legendary lines of the Bobtail. Designed for easy installation on models with or without Sissy Bar Uprights.

Fits '06-later FXST, FXSTB, FXSTC, FXSTS and FLSTSB models. Also fits '07-'08 FXSTSSE/2 with separate purchase of Fender Rack Installation Kit P/N 59320-07. '06 models require separate purchase of Seat Bracket Kit P/N 52030-98 for installation when used with Original Equipment seat. Requires separate purchase of Washer P/N 6397B when used with a solo seat.

<b>59931-08</b>	Gloss Black.	<b>\$99.95</b>
<b>53979-07A</b>	Chrome.	<b>\$99.95</b>

Also available:

### BOBTAIL FENDER RACK INSTALLATION KIT

Required for installation of Bobtail Fender Rack P/N 53979-07A and 56452-07A.

<b>59320-07</b>	<b>\$49.95</b>
-----------------	----------------

Fits '07-'08 FXSTSSE/2 models and '06-later Softail models equipped with Tri-Bar LED Tail Light P/N 69817-07A. Required for installation of Bobtail Fender Rack P/N 53979-07A, 56452-07A or 59931-08. Does not fit with Bobtail Fender Rack P/N 56452-07, 60161-06 or 53979-07.



**A. H-D DETACHABLES SOLO RACK – GLOSS BLACK (53652-05 SHOWN)**



**A. H-D DETACHABLES SOLO RACK – CHROME (53649-05 SHOWN)**



**A. H-D DETACHABLES SOLO RACK – GLOSS BLACK (53612-08 SHOWN)**



**A. H-D DETACHABLES SOLO RACK – GLOSS BLACK (50300099 SHOWN)**



**B. BOBTAIL FENDER RACK – GLOSS BLACK (59931-08 SHOWN)**



**B. BOBTAIL FENDER RACK – CHROME (53979-07A SHOWN)**



**\*WARNING:** Do not use this rack as a seat. Do not exceed the fender rack weight capacity. Using as seat or exceeding this capacity could cause handling problems which could result in loss of control and death or serious injury.

Notice: The prices appearing in this catalog are the manufacturer's suggested retail prices. Actual retail prices may vary.



# SOFTAIL® 249

Backrests & Racks



**C. CHOPPED FENDER LUGGAGE RACK – SOFTAIL BLACKLINE & SLIM**



**D. REAR DOCKING HARDWARE COVER KIT – CHROME**



**D. REAR DOCKING HARDWARE COVER KIT – BLACK**



**E. LOCKING H-D DETACHABLES LATCH KIT – CHROME**



**F. H-D DETACHABLES LATCH KIT – CHROME**



**E. LOCKING H-D DETACHABLES LATCH KIT – BLACK**



## C. CHOPPED FENDER LUGGAGE RACK – SOFTAIL® BLACKLINE® & SLIM® MODELS\*

This Luggage Rack is designed specifically for the rear fender on the FXS model. This simple but elegant rack appears to float above the fender and adds practical luggage space without compromising style. The rear supports conveniently slip over the Turn Signal Relocation Kit docking points and the rack is held in place with a single fastener for easy removal and installation. Rack is shaped to complement the One-Piece H-D® Detachables™ Sissy Bar P/N 52760-11 or 52828-11.

**54298-11** Gloss Black. **\$139.95**

Fits '11-later FLS and FXS models. Requires separate purchase of appropriate Docking Hardware P/N 53932-03A and Turn Signal Relocation Kit P/N 54296-11. Models equipped with Side-Mount License Plate require Relocation Kit P/N 67900127. Models equipped with a center-mount license plate and fender-mounted reflectors require installation of additional components (sold separately): Red Reflector Kit P/N 67900223 or Amber Reflector Kit P/N 67900224.

## D. REAR DOCKING HARDWARE COVER KIT

Disguise the rear docking hardware with these easy-to-install covers. The caps slide over the exposed docking points and are held in place by a strong magnetic pull. The caps are easy to remove when you wish to reinstall detachable accessories. Covers are available with brilliant chrome or durable gloss black finish to match your bike's attitude. Sold in pairs.

Fits many accessory docking hardware kits. Refer to the fitment matrix in this P&A Catalog page 573 or the Parts & Accessories section of [www.harley-davidson.com](http://www.harley-davidson.com) for details.

<b>48218-10</b>	Short Chrome (pair).	<b>\$34.95</b>
<b>48220-10</b>	Large Chrome (pair).	<b>\$34.95</b>
<b>48035-09</b>	Small Chrome (pair).	<b>\$34.95</b>
<b>48221-10</b>	Short Black (pair).	<b>\$34.95</b>
<b>48223-10</b>	Large Black (pair).	<b>\$34.95</b>
<b>48225-10</b>	Small Black (pair).	<b>\$34.95</b>

## E. LOCKING H-D® DETACHABLES™ LATCH KIT

This unique lock replaces the cam lock on your Harley-Davidson Detachables accessories, providing additional security and peace of mind when parking your vehicle. The kit includes two extended-reach barrel-style keys for easy access to the lock. Key registration and replacement service is available. Sold in pairs.

Fits all models equipped with detachable Sideplates, Racks and Tour-Pak® Luggage Carriers (except '09-later Touring models equipped with detachable Solo Tour-Pak Rack).

<b>90300087</b>	Chrome.	<b>\$79.95</b>
<b>90300086</b>	Black.	<b>\$69.95</b>

## F. H-D DETACHABLES LATCH KIT – CHROME

Decorative chrome latches are the perfect way to enhance the appearance of your detachable accessories. Meticulously polished and chrome-plated, these easy-to-install Rotary Latches are a direct replacement for the Original Equipment satin black parts and are a simple way to add a finishing touch to your ride. Latches feature an easy-to-pull finger release to simplify access in hard-to-reach areas.

**12600036** Chrome. **\$49.95**

Fits all models equipped with detachable Sideplates, One-Piece Sissy Bar Uprights, Racks and Tour-Pak Luggage Mounting Racks.



**\*WARNING:** Do not use this rack as a seat. Do not exceed the fender rack weight capacity. Using as seat or exceeding this capacity could cause handling problems which could result in loss of control and death or serious injury.

Notice: The prices appearing in this catalog are the manufacturer's suggested retail prices. Actual retail prices may vary.

## 250 SOFTAIL®

### Saddlebags & Luggage

#### A. H-D® DETACHABLES™ TWO-UP TOUR-PAK® MOUNTING RACK

Designed to be installed and removed in less than 60 seconds, this Tour-Pak® Rack makes the convenience and protection of a Leather Tour-Pak an easy on/off proposition.

**53066-00C** **\$234.95**

Fits '00-'05 Softail® models (except Deuce™). Fits '06 FLST, FLSTF and '06-later FLSTC, FLSTN, FLSTSC models. Designed to accept Color-Matched Sport Tour-Pak or Leather Tour-Pak Luggage System. Requires separate purchase of appropriate Docking Hardware. Some models require the separate purchase of Directional Relocation Kit. Refer to Docking Hardware Chart for specific application. Some EU registration plates may interfere with Tour-Pak Rack. Models with rear fender tip trim can be adapted with the separate purchase of License Plate Relocation Kit P/N 60095-00A. Models equipped with H-D® Detachables™ Saddlebag Kit P/N 88237-07 also require separate purchase of Docking Hardware Kit P/N 54245-10.

**54051-08** **\$234.95**

Fits '06-later FXST, FXSTB, FXSTS, FLSTFSE2 and '07-later FXSTC, FXSTSSE/2, FLSTF, FLSTFB and FLSTSB models. Designed to accept Leather Tour-Pak Luggage. Does not fit with Sport Tour-Pak Luggage. FXSTC models require removal of Original Equipment or and separate purchase of a Fender Mounted seat. Requires separate purchase of appropriate docking hardware kit.



**A. H-D DETACHABLES TWO-UP TOUR-PAK MOUNTING RACK (SHOWN WITH HERITAGE SOFTAIL CLASSIC TOUR-PAK)**

#### B. H-D DETACHABLES SOLO TOUR-PAK MOUNTING RACK

Install the Sport or Leather Tour-Pak in a comfortable back-supporting position. The rack is designed to position the Tour-Pak Luggage for solo riding and is adjustable over a .75" range. Simply remove the Tour-Pak Luggage from the convenient detachable hardware, add a Passenger Pillion and the bike is ready for two-up riding. Tour-Pak, Passenger Backrest Pad and Docking Hardware sold separately.

**53559-04A** **\$159.95**

Fits '00-'05 Softail models (except FXSTD). Fits '06 FLST, FLSTF and '06-later FLSTC, FLSTN, FLSTSC models. Designed to accept Color-Matched Sport Tour-Pak or Leather Tour-Pak Luggage System. Requires separate purchase of appropriate Docking Hardware. Some models require separate purchase of Directional Relocation Kit. See matrix for specific application. Some EU registration plates may interfere with the Tour-Pak Rack. Models with rear fender tip trim can be adapted with the separate purchase of License Plate Relocation Kit P/N 60095-00A.



**B. H-D DETACHABLES SOLO TOUR-PAK MOUNTING RACK (SHOWN WITH HERITAGE SOFTAIL CLASSIC TOUR-PAK)**

#### C. TOUR-PAK® LUGGAGE

Add cross-country luggage capacity to your ride with accessory Tour-Pak Luggage. A cavernous interior will hold one full face helmet or two half helmets. Kit includes backrest pad, interior rubber mat, hardware and instructions. Luggage Capacity: 2500 cubic inches. Dimensions: 18.5" W x 17.0" D x 13.0" H. Racks and docking kits sold separately. International models may require separate purchase of License Plate Relocation Kit P/N 60095-00A.

Fits '04-later XL models (except XL883N, XL1200C, XL1200N and XL1200T) equipped with Solo Tour-Pak Rack. Fits '00-later Softail models (except FLS, FLSTNSE, FLSTSE/2/3 and FXCW, FXCWC FXS, FXSB, FXSBSE, FXSTD, FXSTSSE3) equipped with H-D Detachables Solo or Two-Up Tour-Pak Rack. Fits '97-'13 Touring models equipped with Detachable Two-Up or Solo Tour-Pak Racks.

**53209-09** **\$679.95**  
Leather Heritage Softail Classic Styling.

**53055-05A** **\$679.95**  
Leather Softail Deluxe Styling.

**53690-06A** **\$514.95**  
Smooth Vinyl.



**C. LEATHER TOUR-PAK LUGGAGE – SOFTAIL DELUXE STYLING**

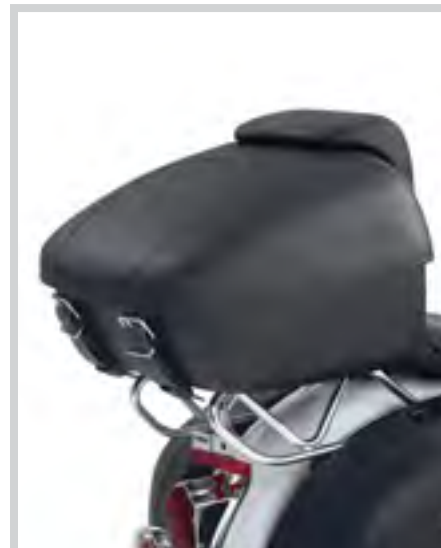

**C. TOUR-PAK LUGGAGE – SMOOTH VINYL**

*Notice: The prices appearing in this catalog are the manufacturer's suggested retail prices. Actual retail prices may vary.*



# SOFTAIL® 251

## Saddlebags & Luggage

### D. SPORT TOUR-PAK® LUGGAGE

Designed to complement the styling of the Softail® and Sportster® Hard Saddlebags, the Sport Tour-Pak® Luggage adds increased storage for your ride across town or across the country. The injection molded Tour-Pak Luggage is lockable and includes an interior rubber mat. Large enough to store most full-faced helmets. Racks and docking kits sold separately. International models may require separate purchase of License Plate Relocation Kit P/N 60095-00A. Luggage capacity: 2245 cubic inches.

Fits '04-later XL models (except XL883N, XL1200C and XL1200N) equipped with Solo Seat and Solo Tour-Pak Rack. Fits '00-'05 Softail models (except Deuce™) and '06 FLST, FLSTF; and '06-later FLSTC, FLSTN, FLSTSC models equipped with H-D® Detachables™ Solo or Two-Up Tour-Pak Rack. Fits '97-'08 Touring models equipped with Detachable Two-Up or Solo Tour-Pak Racks.

<b>53929-12BDK</b>	Primed.	<b>\$569.95</b>
<b>53929-06AV</b>	Birch White.	<b>\$749.95</b>
<b>53929-06DH</b>	Vivid Black.	<b>\$749.95</b>

**Shown with:  
PASSENGER BACKREST PAD FOR SPORT  
TOUR-PAK LUGGAGE**

This Sport Tour-Pak Backrest Pad is styled to complement a wide variety of Original Equipment or custom seats and provides comfortable support for your passenger.

<b>52872-01</b>		<b>\$104.95</b>
-----------------	--	-----------------

Fits models equipped with Sport Tour-Pak Luggage P/N 53929-XXXX.

### E. HARD SADDLEBAGS\*

These hard saddlebags offer not only lockable storage convenience, but they provide style with flowing lines worthy of the Softail model family. They are injection-molded from high-impact composite materials and have approximately 20% more total capacity than the Original Equipment saddlebags used on the Heritage Softail®. Luggage capacity: 2500 cubic inches total.

Fits '08-later FLSTN models (except FLSTNSE). Use Hardware Kit P/N 53075-03 to install Hard Saddlebags on models equipped with H-D Detachables accessories.

<b>90725-08BDK</b>	Primed.	<b>\$1,299.95</b>
<b>90725-08DH</b>	Vivid Black.	<b>\$1,599.95</b>

Fits '08-later FLSTF models. Includes Turn Signal Relocation Kit. Does not fit FLSTFB or '08-later models equipped with Profile Low Rear Suspension P/N 54651-05, 54652-05 or 54001-04. Use Hardware Kit P/N 53075-03 to install Hard Saddlebags on models equipped with H-D Detachables accessories.

<b>90715-08BDK</b>	Primed.	<b>\$1,299.95</b>
<b>90715-08DH</b>	Vivid Black.	<b>\$1,599.95</b>

**Also available:  
SOFTAIL SADDLEBAG HARDWARE KIT**

Required for installation of Hard Saddlebags on specific models equipped with Detachable sissy bar uprights or racks.

<b>53075-03</b>		<b>\$29.95</b>
-----------------	--	----------------

Required on '03-later Softail models (except FXS, FXSB, FXSBSE and FXSTD) equipped with H-D Detachables accessories.

\*NOTE: This product is a "Paint to Order" accessory. Please allow for an average of 5 weeks delivery for this item.

Notice: The prices appearing in this catalog are the manufacturer's suggested retail prices. Actual retail prices may vary.



**D. COLOR-MATCHED SPORT TOUR-PAK LUGGAGE  
(SHOWN WITH H-D DETACHABLES TOUR-PAK RACK AND PASSENGER BACKREST PAD)**



**E. HARD SADDLEBAGS – FLSTF SHOWN**

# 252 SOFTAIL®

## Saddlebags & Luggage

### A. H-D® DETACHABLES™ LEATHER SADDLEBAGS – SMOOTH

These large capacity detachable saddlebags are completely removable with the simple pull of the internal handle, leaving your bike clean and ready to cruise the boulevard. The handsome leather bags feature hidden quick-release clips behind the traditional strap and buckle. When removed, the large capacity bags leave behind two simple, inconspicuous docking points. The bags are compatible with both rigid and detachable accessories when installed with the appropriate docking hardware kits. Luggage capacity: 2400 cubic inches total.

#### **88237-07** **\$859.95**

Fits '03-later FLST (except FLS, FLSTF, FLSTFB, FLSTNSE and FLSTSE/2/3), FLSTC and '03-'05 FX Softail® models (except FXSTD). Models equipped with detachable accessories (except H-D® Detachables™ Tour-Pak® Racks) require separate purchase of Docking Hardware Kit P/N 88256-07. Models equipped with H-D Detachables Tour-Pak Racks require separate purchase of Docking Hardware Kit P/N 54245-10. Models without detachable accessories require separate purchase of Docking Hardware Kit P/N 53932-03A. Models equipped with Rigid Accessories require separate purchase of Docking Hardware Kit P/N 88298-07. '03-'05 FX Softail models require separate purchase of Rear Directional Relocation Kit P/N 69857-07. Does not fit with Passenger Footboards, Rear Saddlebag Guards, Wide Tire Kits, Rear Axle Covers or Flat Lens Turn Signal Kit P/N 68431-95 or 68432-95.

#### **88238-07** **\$879.95**

Fits '06-later FX Softail models (except FXCW, FXCWC, FXS, FXSB, FXSBSE, FXSTD and FXSTSSE/2/3). Also fits '10 FLSTSE models. Models equipped with detachable accessories (except H-D Detachables Tour-Pak Racks) require separate purchase of Docking Hardware Kit P/N 88256-07. Models equipped with H-D Detachables Tour-Pak Racks require separate purchase of Docking Hardware Kit P/N 54245-10. Models without detachable accessories require separate purchase of Docking Hardware Kit P/N 53932-03A. Models equipped with Rigid Accessories also require separate purchase of Docking Hardware Kit P/N 88298-07. FXSTC models also require separate purchase of Docking Hardware Kit P/N 88297-07. All models require separate purchase of Rear Directional Relocation Kit P/N 69857-07. Does not fit with Passenger Footboards, Rear Saddlebag Guards or Rear Axle Covers.

#### **90200616A** **\$859.95**

Fits '07-later FLSTF and FLSTFB models. Models equipped with detachable accessories require separate purchase of Docking Hardware Kit P/N 88256-07. Models without detachable accessories require separate purchase of Docking Hardware Kit P/N 53932-03A. Models equipped with Rigid Accessories require separate purchase of Docking Hardware Kit P/N 88298-07. All models require separate purchase of Rear Directional Relocation Kit P/N 69929-07 or 73369-10. Does not fit with Passenger Footboards or Rear Axle Covers.

#### **Also available:**

#### **REAR TURN SIGNAL RELOCATION KITS**

<b>69857-07</b>	Chrome.	<b>\$79.95</b>
<b>69929-07</b>	Chrome.	<b>\$99.95</b>
<b>73369-10</b>	Black.	<b>\$99.95</b>



**A. H-D DETACHABLES LEATHER SADDLEBAGS – SMOOTH**



#### **STEP 1**

*Equipped with large capacity saddlebags, your bike is ready to take on the longest journey.*



#### **STEP 2**

*Pull and turn the hidden cam lock to release the bags from the docking hardware.*



#### **STEP 3**

*Slide the bag rearward to disengage the mounting bracket and lift the bags away.*



#### **STEP 4**

*You are left with a stripped-down cruiser, ready to prowl the streets.*

NOTE: Some Harley-Davidson® saddlebags are made of leather. Fine leathers or other natural materials WILL gain "character," such as wrinkles or wear, with age. This is normal. A fine, aged patina and character wrinkles are a sign of the extremely high quality materials used to construct your saddlebags. The appearance of scars or marks on the leather are a result of using natural leather panels and should not be thought of as an imperfection. Please use Harley-Davidson Leather Protectant P/N 93600034 to protect your investment.

Notice: The prices appearing in this catalog are the manufacturer's suggested retail prices. Actual retail prices may vary.



# SOFTAIL® 253

Saddlebags & Luggage



**B. H-D DETACHABLES LEATHER SADDLEBAGS – FAT BOY LACING**

## **B. H-D® DETACHABLES™ LEATHER SADDLEBAGS – FAT BOY LACING**

Styled to complement the '07-'11 Fat Boy® model. These large capacity detachable saddlebags are completely removable with the simple pull of the internal handle, leaving your bike clean and ready to cruise the boulevard. The handsome leather bags feature hidden quick-release clips behind the traditional strap and buckle. When removed, the large capacity bags leave behind two simple, inconspicuous docking points. The bags are compatible with both rigid and H-D® Detachables™ accessories when installed with the appropriate docking hardware kits. Luggage capacity: 2400 cubic inches total.

**88306-07A** **\$929.95**

Fits '07-later FLSTF and FLSTFB models. Models equipped with detachable accessories require separate purchase of Docking Hardware Kit P/N 88256-07. Models without detachable accessories require separate purchase of Docking Hardware Kit P/N 53932-03A. Models equipped with Rigid Accessories require separate purchase of Docking Hardware Kit P/N 88298-07. All models require separate purchase of Rear Directional Relocation Kit P/N 69929-07 or 73369-10. Does not fit with Passenger Footboards or Rear Axle Covers.



**C. H-D DETACHABLES LEATHER SADDLEBAGS – BREAKOUT SMOOTH LEATHER**

## **C. H-D DETACHABLES LEATHER SADDLEBAGS – BREAKOUT**

Sized for a ride to the corner store or to Sturgis, these handsome detachable saddlebags are completely removable with the simple pull of the internal handle, leaving your bike clean and ready to cruise the boulevard. When removed, the bags leave behind two simple, inconspicuous docking points that don't cramp your sense of style. The rigid plastic tub, wrapped in genuine leather, offers long-term durability and the leather straps with magnetic tips hide quick-disconnect closures for packing convenience. The bags are compatible with both rigid and detachable accessories when installed with the appropriate docking hardware kits. Luggage capacity: 2100 cubic inches total.

Fits '13-later FXSB and FXSBSE models. Installation requires separate purchase of appropriate Docking Hardware Kit. P/N 52300239. Models equipped with detachable accessories and saddlebags require Docking Kit P/N 52300243.

**90200816** Smooth Leather. **\$839.95**

**90200765** Black. CVO™ FXSBSE. **\$859.95**

### **Shown with:**

#### **DOCKING HARDWARE KIT – BREAKOUT**

Required for installation of H-D Detachables Saddlebags P/N 90200816, 90200765 or 90200784 on Breakout® models.

**52300239** Saddlebags Only. **\$44.95**

Fits '13-later FXSB and FXSBSE models.

**52300243** With Detachable Accessories. **\$59.95**

Fits '13-later FXSB and FXSBSE models equipped with Detachable Saddlebags P/N 90200765 or 90200784 and Detachable Accessories.



**C. H-D DETACHABLES LEATHER SADDLEBAGS – BLACK CVO BREAKOUT**

NOTE: Some Harley-Davidson® saddlebags are made of leather. Fine leathers or other natural materials WILL gain "character," such as wrinkles or wear, with age. This is normal. A fine, aged patina and character wrinkles are a sign of the extremely high quality materials used to construct your saddlebags. The appearance of scars or marks on the leather are a result of using natural leather panels and should not be thought of as an imperfection. Please use Harley-Davidson Leather Protectant P/N 93600034 to protect your investment.

Notice: The prices appearing in this catalog are the manufacturer's suggested retail prices. Actual retail prices may vary.

SOFTAIL

## 254 SOFTAIL®

### Saddlebags & Luggage

#### A. H-D® DETACHABLES™ SADDLEBAGS – SOFTAIL® SLIM® AND BLACKLINE® MODELS

These midsize detachable saddlebags are completely removable with the simple pull of the internal handle, leaving your bike clean and ready to cruise the boulevard. When removed, the bag leaves behind two simple, inconspicuous docking points. Styled to complement the unique look of the stripped down Softail® Slim® and Blackline® models, these bags feature a leather tub and a reinforced textured lid that complement stock and many accessory seats. The traditional leather straps conceal convenient quick-release closures for easy access and the right-hand bag also features a convenient exterior pocket with magnetic catch for easy access to your cell phone or sunglasses. The bags are compatible with H-D® Detachables™ accessories when installed with the appropriate docking hardware kits. Luggage capacity: 1900 cubic inches total.

**90200678** FLS Black Texture. **\$879.95**  
Fits '11-later FLS and FXS models. Models with Original Equipment side mount license plate require separate purchase of License Plate Relocation Kit P/N 67900127. All models require separate purchase of Turn Signal Relocation Kit P/N 67800065 and appropriate docking hardware kit. Models equipped with a center-mount license plate and fender-mounted reflectors require installation of additional components (sold separately): Red Reflector Kit P/N 67900223 or Amber Reflector Kit P/N 67900224.

**90200353B** FXS Black Texture. **\$819.95**  
Fits '11-later FLS and FXS models. Models with Original Equipment side-mount license plate require separate purchase of License Plate Relocation Kit P/N 67900127. Installation requires separate purchase of Turn Signal Relocation Kit P/N 67800065 and appropriate Docking Hardware Kit. Models equipped with detachable saddlebags only requires Docking Kit P/N 90200390 and models equipped with detachable accessories and saddlebags require Docking Kit P/N 90200389. Models equipped with a center-mount license plate and fender-mounted reflectors require installation of additional components (sold separately): Red Reflector Kit P/N 67900223 or Amber Reflector Kit P/N 67900224.

#### Shown with:

##### LICENSE PLATE RELOCATION KIT

Kit replaces Original Equipment side-mount license plate. Required for use with FLS H-D Detachables Saddlebag P/N 90200678 or 90200353B.

**67900127** **\$109.95**  
Fits '11-later FLS and FXS models with side-mount license plate. Required for installation of detachable saddlebags or detachable or upright.

#### Shown with:

##### TURN SIGNAL RELOCATION KIT

Kit moves turn signals from rear fender struts to a license bracket-mounted turn signal bar. Required for installation of H-D Detachables Saddlebags P/N 90200678 or 90200353B.

**67800065** **\$119.95**  
Fits '11-later FLS and FXS models equipped with Detachable Saddlebags P/N 90200678 or 90200353B.

#### Also available:

##### DOCKING HARDWARE KIT

Required for installation of H-D Detachables Saddlebags P/N 90200353B.

**90200389** Detachable Accessories. **\$64.95**  
Fits '11-later FLS and FXS models equipped with H-D Detachables Saddlebags and detachable accessories.

**90200390** Saddlebags Only. **\$44.95**  
Fits '11-later FLS and FXS models equipped with H-D Detachables Saddlebags only.



A. H-D DETACHABLES LEATHER SADDLEBAGS – SOFTAIL SLIM AND BLACKLINE (90200678 SHOWN)



A. H-D DETACHABLES LEATHER SADDLEBAGS – SOFTAIL SLIM AND BLACKLINE (90200353B SHOWN)



A. LICENSE PLATE RELOCATION KIT



A. LICENSE PLATE RELOCATION KIT



# SOFTAIL® 255

Saddlebags & Luggage



**B. HERITAGE CLASSIC QUICK-DETACH SADDLEBAG CONVERSION KIT**

## B. HERITAGE CLASSIC QUICK-DETACH SADDLEBAG CONVERSION KIT

Leave your baggage behind with this innovative set of quick-detach hardware. This kit converts your Original Equipment fixed-mount Heritage Softail® Classic saddlebags to bags that can be removed in just seconds. Just reach inside the bag, pull and twist the locking handle and slide the bags off. You're left with a clean, stripped-down custom look that's ready to prowl. Exclusive 3-point mounting system distributes the load to minimize flex and bounce and retains the Original Equipment weight capacity.

**90200641** **\$194.95**

Fits '03-later FLSTC models equipped with Original Equipment Heritage Softail Classic saddlebags. Installation requires separate purchase of appropriate Docking Hardware Kit. Models equipped with detachable saddlebags alone require Docking Kit P/N 90200669. Models equipped with detachable accessories and saddlebags require Docking Kit P/N 90200670. Does not fit with Passenger Footboards, Rear Saddlebag Guards or Rear Axle Covers.

**Also available:**

### DOCKING HARDWARE KIT

Required for installation of Quick-Detach Saddlebag Kit P/N 90200641 on FLSTC models.

**90200669** Saddlebags Only. **\$49.95**

Fits '03-later FLSTC models equipped with Quick-Detach Saddlebag Kit P/N 90200641 only.

**90200670** With Detachable Accessories. **\$59.95**

Fits '03-later FLSTC models equipped with Quick-Detach Saddlebag Kit P/N 90200641 and detachable accessories.



**B. HERITAGE CLASSIC QUICK-DETACH SADDLEBAG CONVERSION KIT**

## C. HERITAGE FLAT TOP & LOCK KIT

Unique saddlebag structure incorporates a barrel-style lock to secure your Heritage Softail Saddlebags and offers an unobtrusive internal reinforcement bracket that adds rigidity and preserves the original shape after extended periods of exposure to the weather. A custom-shaped plastic inner lid mounts easily to the inside of the leather lid to add additional support. Barrel-style locks are sold separately and can be ordered keyed to match your ignition switch. Kit includes reinforcement hardware for the left and right side bags.

**88373-10A** **\$139.95**

Fits '00-later FLSTC Original Equipment saddlebags and Heritage Style Saddlebag Kit P/N 90876-05. Requires separate purchase of Keyed-to-Match Barrel Lock Kit P/N 90300010. See instruction sheet for additional installation supplies required.

**Also available:**

### LOCKSET – KEYED TO MATCH

Barrel style lock kit includes 2 locks and 2 keys.

**90300010** **\$44.95**

For use with Heritage Flat Top & Lock Kit P/N 88373-10A.



**C. HERITAGE FLAT TOP & LOCK KIT**



**C. HERITAGE FLAT TOP & LOCK KIT**

*Notice: The prices appearing in this catalog are the manufacturer's suggested retail prices. Actual retail prices may vary.*

SOFTAIL

## 256 SOFTAIL®

### Saddlebags & Luggage

#### A. LOCKING LEATHER COVERED RIGID SADDLEBAGS

These saddlebags offer a premium leather look with an extra-durable construction. The blow-molded core keeps the bag rigid and prevents sagging, while the unique lids open outward for added flair. Bags feature locks for additional security. Luggage capacity: 1800 cubic inches total.

**53061-00B** **\$799.95**

Fits '00-later Softail® models (except FLS, FXCW, FXCWC, FXS, FXSB, FXSBSE, FXSTD and FLSTNSE). Also fits '09 FXSTSSE3 models. FXSTC models require separate purchase of Hardware Kit P/N 90573-07. Fits '84-'99 Softail models with separate purchase of Directional Relocation Kit P/N 53692-96. (FLST, FLSTC and FLSTS models do not require this Directional Relocation Kit). (Does not fit '84-'99 models equipped with H-D® Detachables™ accessories.) Does not fit with Rear Axle Covers, Wide Tire Kit P/N 43684-99 or Flat Lens Turn Signal Kit P/N 68431-95.

NOTE: Installation of these saddlebags with the following seats requires the use of Spacer Kit P/N 90976-01A: seats with rider backrests, Sundowner™ seats, stock FLSTF seat, stock FLSTC, FXSTC seat and any other seats that contact the lid of the saddlebag. Spacer Kit not required if mounting with Harley-Davidson® Detachables Racks or Sideplates.



A. LOCKING LEATHER COVERED RIGID SADDLEBAGS

#### B. LOCKING RIGID SADDLEBAGS – SOFTAIL® DELUXE MODELS

Styled to complement the nostalgic look of the Softail Deluxe model, these saddlebags with pleated leather panels are anything but traditional. The rigid core allows the bag to retain its shape even after years of use. The hinged locking lid tilts outward for easy access and the embossed weave pattern, braided edging and chrome concho trim echo the Softail Deluxe seat and pillion for a coordinated look. Luggage capacity: 1900 cubic inches total.

**53015-05B** **\$829.95**

Fits '05-later FLSTN models (except '14-later FLSTNSE). Does not fit with Rear Axle Covers.



B. LOCKING RIGID SADDLEBAGS – SOFTAIL DELUXE MODELS

#### C. LEATHER SADDLEBAGS – CROSS BONES® MODELS

Designed to complement the raw, bare-bones style of the FLSTSB model, these traditional leather saddlebags bring the “bobber” style of an earlier generation back to life. The leather straps and chrome buckles conceal modern quick-release closures for easy access and the textured lid with embossed Bar & Shield logo opens to reveal generous storage space. The rigid backing plate and end panels help the bag retain its shape. These bags are compatible with both rigid and detachable accessories when installed with the appropriate docking hardware kits. Luggage capacity: 1900 cubic inches total.

**90419-08** **\$619.95**

Fits '08-later FLSTSB and '03-later Softail models (except FLS, FLSTC, FLSTF, FLSTFB, FLSTN, FLSTNSE, FXCW, FXCWC, FXS, FXSB, FXSBSE, FXSTD and FXSTSSE models). Does not fit with Rear Axle Covers.



C. LEATHER SADDLEBAGS – CROSS BONES MODELS

NOTE: Some Harley-Davidson® saddlebags are made of leather. Fine leathers or other natural materials WILL gain “character,” such as wrinkles or wear, with age. This is normal. A fine, aged patina and character wrinkles are a sign of the extremely high quality materials used to construct your saddlebags. The appearance of scars or marks on the leather are a result of using natural leather panels and should not be thought of as an imperfection. Please use Harley-Davidson Leather Protectant P/N 93600034 to protect your investment.

Notice: The prices appearing in this catalog are the manufacturer's suggested retail prices. Actual retail prices may vary.



# SOFTAIL® 257

## Saddlebags & Luggage



D. LEATHER SADDLEBAGS – FAT BOY MODELS

### D. LEATHER SADDLEBAGS – FAT BOY® MODELS

Carry your essentials in style with these premium heavy leather saddlebags. They feature a reinforced tub and lid to retain their shape for the long-haul, leather straps and chrome buckles that hide quick-release clips. They are also highly stylized with a leather embossed lid that features decorative chrome spots and Spanish lacing to match the '07 Fat Boy® model. Luggage capacity: 1700 cubic inches total.

**88286-07 \$679.95**

Fits '00-later Softail® models (except FLS, FLSTNSE, FXCW, FXCWC, FXS, FXSB, FXSBSE and FXSTD). Also fits '09 FXSTSSE3 models. FXSTC models require separate purchase of Hardware Kit P/N 90573-07. Also fits '84-'99 FLSTF, FXST, FXSTC and FXSTS models without H-D® Detachables™ when installed with Directional Relocation Kit P/N 53692-96. Does not fit with Rear Axle Covers, Wide Tire Kit P/N 43684-99A or Flat Lens Turn Signal Kit P/N 68431-95.

### E. LEATHER SADDLEBAGS – FXSTC MODELS

Carry your essentials in style with these premium heavy leather saddlebags. They feature a reinforced tub to retain their shape for the long-haul, leather straps that hide quick-release clips and a new chrome buckle to match the FXSTC seat buttons. They are also highly stylized with a smooth leather lid and decorative chrome spots to match the '07 Softail Custom model. Luggage capacity: 1500 cubic inches total.

**88263-07 \$669.95**

Fits '00-later Softail models (except FLS, FLSTNSE, FXCW, FXCWC, FXS, FXSB, FXSBSE, and FXSTD). Also fits '09 FXSTSSE3 models. FXSTC models require separate purchase of Hardware Kit P/N 90573-07. Also fits '84-'99 FLSTF, FXST, FXSTC and FXSTS models without H-D Detachables accessories when installed with Directional Relocation Kit P/N 53692-96. Does not fit with Rear Axle Covers, Wide Tire Kit P/N 43684-99A or Flat Lens Turn Signal Kit P/N 68431-95.



E. LEATHER SADDLEBAGS – FXSTC MODELS

### F. LEATHER SADDLEBAGS – SOFTAIL® MODELS

Shaped to accent the arching rear fender, the rounded profile and rear-swept straps set the style for this traditional saddlebag. Smooth leather flap with embossed Bar & Shield logo features leather straps and chrome buckles that conceal modern quick-release closures for one-handed access. The rigid backing plate and end panels help the bag retain its shape. Luggage capacity: 1800 cubic inches total.

**90133-06B \$609.95**

Fits '00-later Softail models (except FLS, FLSTNSE, FXCW, FXCWC, FXS, FXSB, FXSBSE, and FXSTD). Also fits '09 FXSTSSE3 models. FXSTC models require separate purchase of Hardware Kit P/N 90573-07. Also fits '84-'99 FLSTF, FXST, FXSTC and FXSTS models without H-D Detachables accessories when installed with Directional Relocation Kit P/N 53692-96. Does not fit with Rear Axle Covers, Wide Tire Kit P/N 43684-99A or Flat Lens Turn Signal Kit P/N 68431-95.



F. LEATHER SADDLEBAGS – SOFTAIL MODELS

NOTE: Some Harley-Davidson® saddlebags are made of leather. Fine leathers or other natural materials WILL gain "character," such as wrinkles or wear, with age. This is normal. A fine, aged patina and character wrinkles are a sign of the extremely high quality materials used to construct your saddlebags. The appearance of scars or marks on the leather are a result of using natural leather panels and should not be thought of as an imperfection. Please use Harley-Davidson Leather Protectant P/N 93600034 to protect your investment.

Notice: The prices appearing in this catalog are the manufacturer's suggested retail prices. Actual retail prices may vary.

## 258 SOFTAIL®

### Saddlebags & Luggage

#### A. SYNTHETIC LEATHER SADDLEBAGS – SOFTAIL® MODELS

These handsome bags are the perfect accessory for your Softail® model. The large interior leaves plenty of room for all of your essentials and an inner pocket allows for quick access to small items such as keys, sunglasses and wallets. Luggage capacity: 1900 cubic inches total.

**91537-00C** **\$409.95**

Fits '00-later Softail models (except FLS, FLSTNSE, FXCW, FXCWC, FXS, FXSB, FXSBSE and FXSTD). Also fits '09 FXSTSSE3 models. FXSTC models require separate purchase of Hardware Kit P/N 90573-07. Also fits '84-'99 FLSTF, FXST, FXSTC and FXSTS models without H-D® Detachables™ accessories when installed with Directional Relocation Kit P/N 53692-96. Does not fit with Rear Axle Covers, Wide Tire Kit P/N 43684-99A or Flat Lens Turn Signal Kit P/N 68431-95.

#### B. SOFTAIL LEATHER SADDLEBAGS – FAT BOY STYLING

Styled to complement the '00-'06 Fat Boy® motorcycle with the distinctive Fat Boy concho, wider is definitely better when it comes to these bags, the widest available for Softail models. Luggage capacity: 1550 cubic inches total.

**90320-00D** **\$729.95**

Fits '00-later Softail models (except FLS, FLSTNSE, FXCW, FXCWC, FXS, FXSB, FXSBSE and FXSTD). Also fits '09 FXSTSSE3 models. FXSTC models require separate purchase of Hardware Kit P/N 90573-07. Also fits '84-'99 FLSTF, FXST, FXSTC and FXSTS models without H-D Detachables accessories when installed with Directional Relocation Kit P/N 53692-96. Does not fit with Rear Axle Covers, Wide Tire Kit P/N 43684-99A or Flat Lens Turn Signal Kit P/N 68431-95.

#### C. LEATHER SADDLEBAGS – ROCKER™ MODELS

Heavy leather saddlebags add a practical twist to this one-of-a-kind custom motorcycle. The bags are removable with the simple "lift and slide" motion, so you can dress your bike up or down depending on your mood, leaving behind the attractive chrome support structure. The tapered "messenger" style bags feature traditional strap and buckle details that conceal quick-release clips for easy access. Designed to complement the lean look of the Rocker™ motorcycle, the tapered bags sit low on the bike and wrap the exhaust for a ground-hugging stance. The bags feature rigid-back shells to maintain their shape and an expandable side gusset for added capacity when you need it. Luggage capacity: 1470 cubic inches total (1910 cubic inches expanded).

**90240-08** **\$729.95**

Fits '08-'11 FXCW and FXCWC models. Requires separate purchase of Saddlebag Support Structure P/N 90222-08 and separate purchase of model-specific Saddlebag Installation Kit.

#### Also available:

#### SADDLEBAG INSTALLATION KITS

**90313-08** **\$49.95**

Fits '08-'11 FXCWC models with Original Equipment seat. Required when mounting Saddlebags P/N 90240-08 and Saddlebag Support Structure P/N 90222-08 on FXCWC.

**90233-08** **\$49.95**

Fits '08-'09 FXCW models with Touring System P/N 53935-08 installed. Required when mounting Saddlebags P/N 90240-08 and Saddlebag Support Structure P/N 90222-08 on FXCW models equipped with Luggage Rack/Touring System.

NOTE: Some Harley-Davidson® saddlebags are made of leather. Fine leathers or other natural materials WILL gain "character," such as wrinkles or wear, with age. This is normal. A fine, aged patina and character wrinkles are a sign of the extremely high quality materials used to construct your saddlebags. The appearance of scars or marks on the leather are a result of using natural leather panels and should not be thought of as an imperfection. Please use Harley-Davidson Leather Protectant P/N 93600034 to protect your investment.

Notice: The prices appearing in this catalog are the manufacturer's suggested retail prices. Actual retail prices may vary.



A. SYNTHETIC LEATHER SADDLEBAGS – SOFTAIL MODELS



B. SOFTAIL LEATHER SADDLEBAGS – FAT BOY STYLING



C. LEATHER SADDLEBAGS – ROCKER MODELS



# SOFTAIL® 259

Saddlebags & Luggage



**D. HERITAGE STYLE SADDLEBAGS**

## D. HERITAGE STYLE SADDLEBAGS

Original Equipment on the '06-'08 Heritage Softail® Classic model, these top grade cowhide saddlebags feature reinforced rim and sides to help maintain their shape. The bags are decorated with chrome studs and a chrome-plated brass medallion coined with the Harley-Davidson logo. Saddlebag tops have rivet-reinforced corners and are secured with heavy leather straps that conceal quick-release hardware. Luggage capacity: 2200 cubic inches total.

**90876-05 \$729.95**

Fits '00-later FLST (except FLSTNSE and FLSTSE/2/3) and FLSTC models. FLST models require separate purchase of Saddlebag Hardware Kit P/N 79304-06.

## E. SINGLE-SIDED SWINGARM BAG

Less is more. With enough room for the essentials, these stylish Single-Sided Swingarm Bags eliminate the need to stuff your pockets or bungee a bag across the passenger pillion. Shaped to accent the unique Softail® swingarm, these compact bags are constructed of heavyweight leather. The easy-access bag features a pouch-style flap lid that is secured with two quick-disconnect clips that are hidden behind traditional straps and buckles. The semirigid-backed bag is secured to the left side of the swingarm with easy to install adjustable quick-release straps. Bag is available in your choice of rich black leather or distressed brown leather finish. Luggage capacity: 400 cubic inches.

Fits '00-later Softail models (except FXCW, FXCWC, FLSTC, FLSTNSE and FLSTSE models). Does not fit models equipped with rear axle covers, left hand tool box, passenger footboards, chrome swingarm covers or saddlebag guards.

**90200417 Black Smooth Leather. \$199.95**

**90200456 Brown Distressed Leather. \$199.95**



**E. SINGLE-SIDED SWINGARM BAG – BLACK SMOOTH LEATHER**



**E. SINGLE-SIDED SWINGARM BAG – BROWN DISTRESSED LEATHER**

## F. LEATHER THROW-OVER SADDLEBAGS

These traditional Leather Throw-Over bags feature large side gussets for increased capacity and full-length straps with hidden quick-disconnect clips for easy access.

**91008-82C \$369.95**

Fits '82-later XL (except XL1200T), '08-later Dyna® (except FLD) and '84-'99 Softail models equipped with H-D® Chrome Saddlebag Supports.

## G. SYNTHETIC LEATHER THROW-OVER ADJUSTABLE SADDLEBAGS

Synthetic leather with embossed "Eagle Wing" logo. 11.0" x 10.0" x 3.75".

**90570-86TA \$119.95**

Fits '82-'03 XL, '91-'05 Dyna® and '84-'99 Softail models equipped with saddlebag supports.



**F. LEATHER THROW-OVER SADDLEBAGS**



**G. SYNTHETIC LEATHER THROW-OVER ADJUSTABLE SADDLEBAGS**

NOTE: Some Harley-Davidson® saddlebags are made of leather. Fine leathers or other natural materials WILL gain "character," such as wrinkles or wear, with age. This is normal. A fine, aged patina and character wrinkles are a sign of the extremely high quality materials used to construct your saddlebags. The appearance of scars or marks on the leather are a result of using natural leather panels and should not be thought of as an imperfection. Please use Harley-Davidson Leather Protectant P/N 93600034 to protect your investment.

Notice: The prices appearing in this catalog are the manufacturer's suggested retail prices. Actual retail prices may vary.

SOFTAIL

# 260 SOFTAIL®

Saddlebags & Luggage

## A. REAR SADDLEBAG GUARDS – CHROME\*

Saddlebag guards provide a style borrowed from the past that makes a unique statement here and now. Includes mounting hardware and instructions.

**49261-00A** **\$229.95**

Fits '00-later FLST, FLSTC and '00-'05 FXST, FXSTB and FXSTS models. FLSTC models require Saddlebag Relocation Kit P/N 90238-00.

**49360-08** **\$229.95**

Fits '05-later FLSTN models. Does not fit FLSTNSE models. Fits with Saddlebag Kit P/N 88286-07 and 53015-05B. Does not fit with Passenger Footboard Kits. Does not fit with Tool Box Kit P/N 64937-00A or 64938-00.

**Also available:**

**SADDLEBAG BRACKET RELOCATION KIT** (not shown)  
Required for installation of FLSTS Rear Saddlebag Guards P/N 49258-00A and FLSTC Rear Saddlebag Guard P/N 49261-00.

**90238-00** **\$14.95**

Fits '00-later FLSTS, FLSTC and FLSTSB models.



**A. REAR SADDLEBAG GUARDS – CHROME  
(49261-00A SHOWN)**



**A. REAR SADDLEBAG GUARDS – CHROME  
(49360-08 SHOWN)**

## B. HERITAGE SPRINGER® REAR SADDLEBAG GUARDS\*

Inspired by the nostalgic look of the '50s, these classic-looking touring bars capture the magic of an era gone by. Take a ride back in time with these unique bars, styled exclusively for the Heritage Springer® models. Bars are entirely chrome-plated. Includes mounting hardware.

**49258-00A** **\$199.95**

Fits '00-'03 FLSTS models. Requires the separate purchase of Saddlebag Relocation Kit P/N 90238-00.

## C. SADDLEBAG SUPPORTS – CHROME

Fit with or without Sissy Bar Uprights, attach easily and protect bags from contacting brake and swingarm.

**91790-84C** **\$99.95**

Fits '84-'06 FL Softail® models (except FLSTS) and '84-'05 FX Softail models (except FXSTD). Will not fit with H-D® Detachables™ accessories.

## D. UNIVERSAL SADDLEBAG LOCK KIT

Keep the contents of your existing soft-sided saddlebags safe from the grab-and-go thief. This unique kit features two extra-small barrel locks that can replace existing saddlebag snaps to perform double duty as locks or as snaps when you don't need to lock your bags. Can be keyed to match your barrel-style ignition key. Sold in pairs.

Fits most soft-sided leather and vinyl saddlebags. Does not fit FLHRC and FLHRS.

**90300003** Keyed To Match. **\$59.95**

**90300017** Random Key Code. **\$49.95**



**B. HERITAGE SPRINGER  
REAR SADDLEBAG GUARDS**



**C. SADDLEBAG SUPPORTS – CHROME**

## E. SADDLEBAG TRAVEL-PAKS

Water-resistant liners make packing easy. Features inner pockets for extra storage and an embroidered Bar & Shield logo.

**91959-97** **\$54.95**

Liner dimensions: 12.0"W x 10.0"T x 5.0"D.



**D. UNIVERSAL SADDLEBAG LOCK KIT**



**E. SADDLEBAG TRAVEL-PAKS**



**\*WARNING:** These guards may provide limited leg and cosmetic vehicle protection under unique circumstances (fall over while stopped, very low speed slide). They are not made nor intended to provide protection from bodily injury in a collision with another vehicle or any other object.

*Notice: The prices appearing in this catalog are the manufacturer's suggested retail prices. Actual retail prices may vary.*



# SOFTAIL® 261

## Saddlebags & Luggage



**F. AUXILIARY POWER PORT – SADDLEBAG MOUNT**



**G. USB CHARGING ADAPTOR**

**F. AUXILIARY POWER PORT – SADDLEBAG MOUNT**

Charge your cell phone or portable music player from this handy saddlebag-mounted 12-volt power port. Conventional “cigarette lighter” style power outlet accepts most 12V automotive power adaptor plugs and features a flip-top cover to protect the port while not in use.

**69200091** **\$40.95**

Fits models equipped with 12-volt battery. Does not fit VRSC™ models, throw-over or swingarm bags. Not for use with Accessory Fitted Liners or Premier Liners. Requires separate purchase of Battery Charging Harness P/N 94624-97B, if not already equipped.

**G. USB CHARGING ADAPTOR**

Charge your cell phone, MP3 players and other hand-held devices while on the road. Compact Adaptor plugs into standard or accessory 12-volt power ports and provides a standard USB-style outlet that accepts many phone and music player power cords.

**69200357** **\$19.95**

For use with 12V Auxiliary Power Port.

**H. HERITAGE LEATHER TOURING BAG**

Styled to match Heritage Softail® Classic models, this bag features chrome spots, buckles and heavy-duty wide leather straps. With quick-disconnect clips for easy removal and 720 cubic inches of storage space, this bag is as convenient as it is cavernous.

**98864-97** **\$329.95**

Fits Softail® models equipped with Luggage Rack P/N 53465-87B, 56465-86A or 53713-96.

**I. MESSENGER BAG SISSY BAR LUGGAGE**

Tapered “messenger” style bag easily mounts to the sissy bar and adds needed storage space to your custom ride. The heavy leather lid with embossed Bar & Shield logo features a traditional strap and buckle look, but conceals quick-disconnect clips for easier access. The rigid back shell helps the bag maintain its shape and the built-in water-resistant polyester liner with drawstring closure keeps items dry inside. Dimensions: 10.0” W x 12.0” T x 9.5” D; Luggage capacity: 925 cubic inches. Installation requires a sissy bar upright, backrest pad and luggage rack.

**94792-08** **\$169.95**

Fits most Harley-Davidson® models equipped with passenger backrest and luggage rack. Does not fit Mini or Short Uprights, or uprights with bucket or oversized backrest pads.

**J. LEATHER SISSY BAR BAGS**

This Sissy Bar Bag is an easy way to add extra storage. High-quality molded-leather construction holds its shape and is a convenient place to store quick-access items. Features a turn-buckle closure for a snug fit.

Fits most Harley-Davidson Medallion/Insert Style Sissy Bar Uprights, Luggage Racks and Pad. Will not fit with Mini, Short, VRSC, XR, XG or FXSTD Uprights. Will not fit with backrest pad mounted luggage.

**52997-98** Bar & Shield Logo Concho. **\$99.95**

**52998-98** Chrome Studs. **\$99.95**



**H. HERITAGE LEATHER TOURING BAG**



**I. MESSENGER BAG SISSY BAR LUGGAGE**



**J. LEATHER SISSY BAR BAG – BAR & SHIELD LOGO CONCHO**



**J. LEATHER SISSY BAR BAG – CHROME STUDS**

NOTE: Some Harley-Davidson® saddlebags are made of leather. Fine leathers or other natural materials WILL gain “character,” such as wrinkles or wear, with age. This is normal. A fine, aged patina and character wrinkles are a sign of the extremely high quality materials used to construct your saddlebags. The appearance of scars or marks on the leather are a result of using natural leather panels and should not be thought of as an imperfection. Please use Harley-Davidson Leather Protectant P/N 93600034 to protect your investment.

Notice: The prices appearing in this catalog are the manufacturer’s suggested retail prices. Actual retail prices may vary.

## 262 SOFTAIL®

Saddlebags & Luggage

### A. SOFTAIL® TOOLBOX

Add a traditional touch to your modern classic. Mirror-chrome and gloss black teardrop-shaped Toolbox with latch provides just enough convenient storage space for your personal items. Kit includes chrome-plated mounting brackets and universal barrel-style locks with keys. Top-hinged toolbox accepts nylon Toolbox Liner P/N 91838-92 (sold separately) for packing ease.

**64227-08** Right Hand, Chrome. **\$94.95**  
Fits '08-later FXST, FXSTB and FXSTC models. All models require Spacer Kit P/N 49352-00 if used with Original Equipment passenger footpegs. Spacer kit not required with Passenger Footboard Kit P/N 50602-00A.

**64216-09** Left Hand, Gloss Black. **\$94.95**  
Fits '08-later FXS, FXST, FXSTB, FXSTC, FXSTSSE2, FLS, FLSTF, FLSTFB and FLSTSB models. All models require Spacer Kit P/N 49352-00 if used with Original Equipment passenger footpegs. Spacer kit not required with Passenger Footboard Kit P/N 50602-00A. FLSTSB models require separate purchase of Screw P/N 94399-92T and Washer P/N 6595HB.

**64230-08** Left Hand, Chrome. **\$94.95**  
Fits '08-later FXS, FXST, FXSTB, FXSTC, FXSTSSE2, FLS, FLSTF, FLSTFB and FLSTSB models. All models require Spacer Kit P/N 49352-00 if used with Original Equipment passenger footpegs. Spacer kit not required with Passenger Footboard Kit P/N 50602-00A. FLSTSB models require separate purchase of Screw P/N 94399-92T and Washer P/N 6595HB.

**64938-00** Left Hand, Chrome. **\$94.95**  
Fits '00-'06 FLSTF (except '06 FLSTFSE2), '00-'05 FXST, FXSTB, FXSTS and '05-'07 FLST and FLSTN models. All models (except FLSTN) require Spacer Kit P/N 49352-00 if used with Original Equipment passenger footpegs. Not required with Passenger Footboards P/N 50602-00A.

**64937-00A** Right Hand, Chrome. **\$94.95**  
Fits '00-'05 FXST, FXSTB, FXSTS, '00-'07 FLST, FLSTN, FLSTC, FLSTS and FLSTSC models. All models (except FLSTN) require Spacer Kit P/N 49352-00 if used with Original Equipment passenger footpegs. Not required with Passenger Footboards P/N 50955-00 and 50602-00A. '00-'07 FLSTC models require Saddlebag Relocation Kit P/N 90238-00 with Original Equipment footpegs or footboards.

### B. SOFTAIL TOOLBOX LINER

Made of tough 1000 denier nylon with silkscreened Bar & Shield logo. Features a full-length zipper and two elastic straps to secure several tools.

**91838-92** **\$19.95**  
Fits both left and right side toolboxes.



A. SOFTAIL TOOLBOX – CHROME



A. SOFTAIL TOOLBOX – GLOSS BLACK



A. SOFTAIL TOOLBOX LINER



B. SOFTAIL TOOLBOX LINER

*Notice: The prices appearing in this catalog are the manufacturer's suggested retail prices. Actual retail prices may vary.*





**C. BOOM! AUDIO MUSIC PLAYER TANK POUCH**



**C. BOOM!™ AUDIO MUSIC PLAYER TANK POUCH**

This portable music system pouch is designed for motorcycle use. The neoprene jacket offers hard-core protection for your portable music device, while the built-in magnets hold the pouch securely to the fuel tank. The clear play-through window permits touch-screen control and the anti-skid interior allows the pouch to accommodate players of various sizes. The clamshell design makes inserting your player into the pouch quick and easy and the double zipper allows for headphone and output cables to exit the pouch at any point on top, bottom or one side of the pouch. Simply plug in your headphones or connect your in-dash Advanced Audio Radio with an auxiliary cable or Boom!™ Audio iPod® Interface and enjoy your music collection. Works well with many MP3 and other personal music players, but should not be used with hard-disk memory players. Window measurement: 2.25" W x 4.0" H.

**76000193** **\$44.95**  
Fits models with steel fuel tanks or airbox covers.

**D. MAGNETIC TANK TOTE**

De-clutter your pockets. This compact and convenient magnetic pouch is the ideal place to store small items that would normally go in your jeans pocket. It's also the perfect way to enjoy the benefits of SiriusXM® Satellite Radio, NavWeather® and NavTraffic® on your non-fairing equipped motorcycle. Just slip the Road Tech™ zūmo® SiriusXM disc antenna into this pouch and the strong magnets will secure it to the top of the fuel tank yet make it easy to move your Road Tech zūmo from the bike to the car. The durable neoprene jacket with zippered closure will keep your items safe for the ride. An embroidered Bar & Shield logo finishes the look. Pouch dimensions: 4.0" W x 5.5" H.

**76000061** **\$34.95**  
Fits models with steel fuel tanks or airbox covers.



**D. MAGNETIC TANK TOTE**



**E. FORK BAG – SOFTAIL ROCKER**

**E. FORK BAG – SOFTAIL® ROCKER™**

Add a touch of leather up front with this functional Fork Bag. Styled to complement the Softail® Rocker™ model's fuel tank badge and accessory saddlebags, the embossed Bar & Shield logo makes a simple statement. The durable mounting bracket helps keep the bag in place and the heavyweight leather will last for years to come.

**92352-08** **\$84.95**  
Fits '08-'11 FXCW and FXCWC models.

**F. RIDER CUP HOLDER**

Shaped to blend with the contours of your Harley-Davidson® motorcycle, this unique cup holder is easy to reach without cluttering the handlebar. The attractive chrome mount securely attaches to the frame downtube, and sweeps rearward to support the cup holder. The soft-touch insulated holder flexes to grip the beverage, and features a perforated bottom to drain away rain water. Kit includes model-specific clamp, support rod, cup holder and all required mounting hardware.

**57478-11** **\$49.95**  
Fits '06-later Dyna® models.

**50700002** **\$54.95**  
Fits '00-later Softail models.

**50700001** **\$54.95**  
Fits '09-later Touring models.



**F. RIDER CUP HOLDER**

SOFTAIL

*Notice: The prices appearing in this catalog are the manufacturer's suggested retail prices. Actual retail prices may vary.*

## 264 SOFTAIL®

### Fuel Tank Panels

#### A. CAT'S EYE CONSOLE TANK PANEL WITH POUCH

Trim your fuel tank with high-quality, durable genuine leather. The tank panel features a convenient leather-covered hard-shell storage pouch that retains its shape and a fingertip turn-buckle to secure the flap for easy access. The embossed Bar & Shield logo adds a classic finishing touch and is styled to complement Embossed Bar & Shield Logo Windshield Bag P/N 58308-95.

**91643-09 \$99.95**

Fits '09-later FLS and FLSTC with Original Equipment console. Also fits '08-later FLSTSB models equipped with two-up seat.

#### B. LEATHER TANK PANEL WITH FAT BOY® CONCHO

Give your Softail® model additional attitude with this leather tank panel featuring an authentic Fat Boy® concho.

**91134-01 \$59.95**

Fits '93-'03 FXDWG and '00-later Softail models (except FXCW, FXCWC, FXS, FXSB, FXSBSE, FXSTD, FXSTSSE/2/3, FLS, FLSTFSE2, FLSTNSE, FLSTSB, FLSTSE/2/3 and '09-later FLSTC).

#### C. LEATHER TANK PANEL WITH EMBOSSED SKULL LOGO

Add a little menace to your bike with this skull-embossed leather tank panel.

**91001-01 \$49.95**

Fits '93-'03 FXDWG and '00-later Softail models (except FXCW, FXCWC, FXS, FXSB, FXSBSE, FXSTD, FXSTSSE/2/3, FLS, FLSTFSE2, FLSTNSE, FLSTSB, FLSTSE/2/3 and '09-later FLSTC).

#### D. BROWN DISTRESSED LEATHER TANK PANEL

Styled to complement Distressed Brown Leather seats and saddlebags, this tank panel is the perfect choice to complete your vintage western saddle look. Easy-to-install panel features an embossed Bar & Shield logo.

**70900103 \$59.95**

Fits '00-later Softail models (except FXCW, FXCWC, FXS, FXSB, FXSBSE, FXSTD, FXSTSSE/2/3, FLS, FLSTFSE2, FLSTNSE, FLSTSB, FLSTSE/2/3 and '09-later FLSTC). Also fits '93-'08 FXDWG, '06 FXD35 and '07-later FXDF and FXDC models. '93-'03 FXDWG models require the separate purchase of Clip P/N 10102 and O-Ring P/N 11174.

#### E. PREMIUM TANK PANEL WITH POUCH

This leather tank panel features an over-sized pouch for convenient "at your fingertips" storage. The heavy duty leather pouch will maintain its shape for miles to come while the bold chrome Bar & Shield medallion sits proudly on the flap for all to admire.

**91135-09 \$99.95**

Fits '00-later Softail models (except FXCW, FXCWC, FXS, FXSB, FXSBSE, FXSTD, FXSTSSE/2/3, FLS, FLSTFSE2, FLSTNSE, FLSTSB, FLSTSE/2/3 and '09-later FLSTC). Also fits '93-'08 FXDWG, '06 FXD35 and '07-later FXDF and FXDC models. '93-'03 FXDWG models require the separate purchase of Clip P/N 10102 and O-Ring P/N 11174.



A. CAT'S EYE CONSOLE TANK PANEL WITH POUCH



B. LEATHER TANK PANEL WITH FAT BOY CONCHO



C. LEATHER TANK PANEL WITH EMBOSSED SKULL LOGO



D. BROWN DISTRESSED LEATHER TANK PANEL



E. PREMIUM TANK PANEL WITH POUCH

*Notice: The prices appearing in this catalog are the manufacturer's suggested retail prices. Actual retail prices may vary.*



# SOFTAIL® 265

## Fuel Tank Panels



**F. LEATHER TANK PANEL WITH POUCH**



**G. LEATHER TANK PANEL WITH POUCH FOR FAT BOY MODELS**

### F. LEATHER TANK PANEL WITH POUCH

This durable leather panel features an integrated storage pouch, perfect for the small items you need to keep handy. Constructed of tough steerhide over a rigid molded base, the flap features a chrome decorative button and a tab with magnetic closure.

**91758-07** **\$99.95**

Fits '93-'03 FXDWG and '00-later Softail® models (except FXCW, FXCWC, FXS, FXSB, FXSBSE, FXSTD, FXSTSSE/2/3, FLS, FLSTFSE2, FLSTNSE, FLSTSB, FLSTSE/2/3 and '09-later FLSTC).

### G. LEATHER TANK PANEL WITH POUCH FOR FAT BOY MODELS

This durable leather panel features an integrated storage pouch, perfect for the small items you need to keep handy. Constructed of tough steerhide over a rigid molded base and decorated with Spanish lacing to match the '07-later Fat Boy® model.

**91621-07** **\$99.95**

Fits '00-later Softail models (except FXCW, FXCWC, FXS, FXSB, FXSBSE, FXSTD, FXSTSSE/2/3, FLS, FLSTFSE2, FLSTNSE, FLSTSB, FLSTSE/2/3 and '09-later FLSTC). Also fits '93-'08 FXDWG, '06 FXD35 and '07-later FXDF and FXDC models. '93-'03 FXDWG models require the separate purchase of Clip P/N 10102 and O-Ring P/N 11174.



**H. LEATHER TANK PANEL WITH TEARDROP CONCHO AND POUCH**



**I. LEATHER TANK PANEL WITH POUCH, CONCHO AND CHROME STUDS**

### H. LEATHER TANK PANEL WITH TEARDROP CONCHO AND POUCH

Stylish leather tank panel puts a convenient storage pouch right at your fingertips. Embossed basket-weave pattern and bright chrome teardrop concho matches the Softail Springer™ Classic trim and complements other smooth leather and vinyl seats and bags.

**91469-06** **\$99.95**

Fits '00-later Softail models (except FXCW, FXCWC, FXS, FXSB, FXSBSE, FXSTD, FXSTSSE/2/3, FLS, FLSTFSE2, FLSTNSE, FLSTSB, FLSTSE/2/3 and '09-later FLSTC). Also fits '93-'08 FXDWG, '06 FXD35 and '07-later FXDF and FXDC models. '93-'03 FXDWG models require the separate purchase of Clip P/N 10102 and O-Ring P/N 11174.

### I. LEATHER TANK PANEL WITH POUCH, CONCHO AND CHROME STUDS

**91407-00** **\$99.95**

Fits '93-'03 FXDWG and '00-later Softail models (except FXCW, FXCWC, FXS, FXSB, FXSBSE, FXSTD, FXSTSSE/2/3, FLS, FLSTFSE2, FLSTNSE, FLSTSB, FLSTSE/2/3 and '09-later FLSTC).

**91177-97** Fits '84-'99 Softail models. **\$99.95**

### J. LEATHER TANK PANEL WITH POUCH AND BRAIDED TRIM

This decorative, yet durable leather panel has an integrated storage pouch, perfect for those small items you like to keep handy. Constructed of tough steerhide over a rigid, molded base and decorated with H-D® concho and braided leather lacing.

**91409-00** **\$99.95**

Fits '93-'03 FXDWG and '00-later Softail models (except FXCW, FXCWC, FXS, FXSB, FXSBSE, FXSTD, FXSTSSE/2/3, FLS, FLSTFSE2, FLSTNSE, FLSTSB, FLSTSE/2/3 and '09-later FLSTC).

**91026-94A** Fits '84-'99 Softail models. **\$99.95**

### K. LEATHER TANK PANEL WITH POUCH, CONCHO AND BRAIDED FLAP

**91408-00** **\$99.95**

Fits '93-'03 FXDWG and '00-later Softail models (except FXCW, FXCWC, FXS, FXSB, FXSBSE, FXSTD, FXSTSSE/2/3, FLS, FLSTFSE2, FLSTNSE, FLSTSB, FLSTSE/2/3 and '09-later FLSTC).



**J. LEATHER TANK PANEL WITH POUCH AND BRAIDED TRIM**



**K. LEATHER TANK PANEL WITH POUCH, CONCHO AND BRAIDED FLAP**

*Notice: The prices appearing in this catalog are the manufacturer's suggested retail prices. Actual retail prices may vary.*

## 266 SOFTAIL®

### Fuel Tank Panels

#### A. DASH PANEL EXTENSION – CHROME BILLET

Chrome-plated billet aluminum trim kit adds a dash of chrome from console to the front of the seat, adding a custom touch without the expense of a custom tank. Easy to install, the dash panel kit includes a formed gasket to protect the tank's surface.

**71296-07** **\$79.95**

Fits '00-later Softail® models (except FXCW, FXCWC, FXS, FXSB, FXSBSE, FXST-Aus, FXSTD, FXSTSSE/2/3, FLS, FLSTFSE2, FLSTNSE, FLSTSB, FLSTSE/2/3 and '09-later FLSTC).



A. DASH PANEL EXTENSION – CHROME BILLET

#### B. DASH PANEL EXTENSION – CHROME

Stretch the lines of your chrome dash panel the full length of the fuel tank. This chrome-plated trim kit continues the lines and finishes of your standard tank panel to the front of the seat, adding a custom touch without the expense of a custom tank.

**71283-01** **\$41.95**

Fits '00-later Softail models (except FXCW, FXCWC, FXS, FXSB, FXSBSE, FXST-Aus, FXSTD, FXSTSSE/2/3, FLS, FLSTFSE2, FLSTNSE, FLSTSB, FLSTSE/2/3 and '09-later FLSTC).



B. DASH PANEL EXTENSION – CHROME

#### C. LOW-PROFILE FUEL TANK CONSOLE – CHROME

Visually stretch the look of your Softail model's fuel tank. The custom console brings sweeping bands of chrome that run the length of the tank to add a contemporary low-profile look. The speedometer housing features aircraft-style "bolt-on" trim ring and the ignition switch, turn signal and indicator lights are set into a smooth mirror-chrome field. The console accepts Original Equipment gauges, speedometer switch and wiring harness.

**71208-07** **\$319.95**

Fits '00-'10 Softail models (except FXSTD, FXCW, FXCWC, FLSTSB and models equipped with a Color Shop Stretched Fuel Tank). Will not fit with Combination Speedometer/Tachometer kits. Will not fit with Brawler®, Stripper®, Sidekick®, Sidekick Custom or Rallyrunner® Seats or with Skull Fuel Cap P/N 75097-05.



C. LOW-PROFILE FUEL TANK CONSOLE – CHROME

#### D. CONSOLE KIT FOR SOFTAIL MODELS – CHROME

Stretch out your Softail tank with this full-length tank console. Die-cast and chrome-plated for custom attitude, the console makes use of the Original Equipment speedometer, ignition switch, indicator lights and wiring harness – so all you have to do is bolt it on and ride. Kit includes hardware and gaskets necessary for installation.

**71202-03** **\$204.95**

Fits '00-'10 Softail models (except FXSTD, FXCW, FXCWC, FLSTSB, '09-'10 FLSTC and models equipped with Color Shop Stretched Fuel Tank).



D. CONSOLE KIT FOR SOFTAIL MODELS – CHROME

*Notice: The prices appearing in this catalog are the manufacturer's suggested retail prices. Actual retail prices may vary.*



# NEVER IN A TIGHT SPOT

On the road, you've got to feel good in the saddle. Whether you're cruising around town or out for the long haul, your bike should feel like an extension of yourself. So, once you've picked the bike, it's time to choose the options that best equips your ride to your personal dimensions.

## SUSPENSION

While many current Softail® models are already equipped with low-profile suspension, Harley offers optional front and rear lowering kits to tailor your bike to your size. Or, if you are willing to exchange the low-profile "slammed" look for improved ride comfort, Comfort Flex standard-length shocks deliver a superior ride through a longer stroke.



## ESTABLISH YOUR POSITION



### HANDLEBARS

Where the bar positions your hands, wrists and arms directly affects how you feel on the motorcycle. The shape of the bar determines your reach to the hand controls and, therefore, your overall comfort.



### SEATS

The right seat is equal parts ergonomics and comfort. Its shape anchors your position and determines the reach to the ground and to the controls and the padding supports your tailbone and hips to relieve stress and pressure. Pick the right one for you – and your passenger.



### FOOT CONTROLS

Where your feet contact the controls can often determine how many miles you can put on in a day. Footboards position your feet below the knee for an upright riding posture, while forward controls stretch your legs for a relaxed, laid-back posture.

## THE FIT SHOP LIST



Here are a few options to consider when outfitting your bike to fit you. Find your model and flip to the pages for more information. For more details, visit [h-d.com/fitshop](http://h-d.com/fitshop).

THE FIT SHOP LIST	2015	SUSPENSION	SEATS	HANDLEBARS	FOOT SUPPORTS
	FXSB	Low Suspension is Stock	Reduced Reach® Seat	Reduced Reach Bar Fat Mini-Ape Bar	-
	FLSTF/ FLSTFB	Profile® Low Front Suspension Profile Low Rear Suspension	Super Reduced Reach Seat Reduced Reach Seat Brawler® / Sidekick® Seat Badlander® Seat Signature Series® Seat Tallboy® Seat	Extreme Reduced Reach Bar Beach Bar Narrow Beach Bar Fat 12" or 16" Ape Bar Street Slammer Bar Fat Drag Bar Hollywood Bar	Whiskers Highway Bar Forward Control (FLSTF) Extended Brake Lever Extended Shift Lever
	FLSTC	Profile Low Front Suspension Profile Low Rear Suspension	Super Reduced Reach Seat Reduced Reach Seat Badlander Seat Signature Series Seat	Extreme Reduced Reach Bar Beach Bar Narrow Beach Bar Fat 12" or 16" Ape Bar Street Slammer Bar Hollywood Bar	Whiskers Highway Bar Forward Control Kit Extended Brake Lever Extended Shift Lever Adjustable Passenger Pegs
	FLSTN	Profile Low Front Suspension Comfort Flex Rear Shocks	Super Reduced Reach Seat Reduced Reach Seat Signature Series Seat Tallboy Seat	Extreme Reduced Reach Bar Beach Bar Fat 12" or 16" Ape Bar Street Slammer Bar Hollywood Bar	Whiskers Highway Bar Forward Control Kit Extended Brake Lever Extended Shift Lever
	FLS	Profile Low Front Suspension Comfort Flex Rear Shocks	Reduced Reach Seat	Pull Back Riser Kit Extreme Reduced Reach Bar Beach Bar Fat 12" or 16" Ape Bar Street Slammer Bar	Whiskers Highway Bar Extended Brake Lever Extended Shift Lever

## 268 SOFTAIL®

Suspension

### A. PROFILE® LOW FRONT SUSPENSION\*

Designed by Harley-Davidson® to lower the front fork approximately 1.0" while preserving ride quality. A perfect addition during the installation of chrome or gloss black lower fork sliders, the kit includes springs that are progressively wound for a compliant, yet controlled ride. Must only be installed on vehicles equipped with low-profile rear suspension.

**54758-07** **\$104.95**

Fits '07-later FLS, FLSTC, FLSTN, '08-later FLSTF, FLSTFB and '14-later FLSTNSE models. FLSTC, FLS (AUS/BRZ/APC), FLSTF and FLSTF Special (Europe/UK) models must also be equipped with Profile® Low Rear Suspension Kit P/N 54651-05, 54652-05 or 54001-04A.

**54596-94** **\$199.95**

Fits '89-'06 FLST, FLSTC, FLSTF and FLSTN Softail® models. Must only be installed on vehicles equipped with Profile Low Rear Suspension P/N 54588-94, 54665-03, 54648-00A, 54651-05, 54652-05 or 54001-04A.

**54621-05** **\$104.95**

Fits '00-later FXST, FXSTB and FXSTC models equipped with Profile Low Rear Suspension P/N 54648-00A, 54665-03, 54651-05, 54652-05 or Rear Lowering Kit P/N 54001-04A. Also fits '00-'05 FXDWG models equipped with Low Rear Shock Kit P/N 54594-03 or Premium Billet Profile Low Rear Suspension P/N 54592-03.



### B. PREMIUM RIDE CARTRIDGE FORK KIT

This Cartridge Fork Kit converts the standard Original Equipment front suspension into a high-performance suspension with superior ride quality. The Cartridge Fork Kit complements low and standard height rear shocks by providing a balanced suspension system capable of delivering superior ride characteristics. The front fork kit improves resistance to front brake dive, improves cornering and enhances bottoming control. A perfect addition during the installation of chrome or gloss black lower fork sliders, the kit includes cartridge, damper tube, fork tube, spring and oil seals.

**45500141** **\$349.95**

Fits '00-later FL Softail models (except FLSTS, FLSTSB, FLSTSC, FLSTFSE2 and '07 FLSTF).



A. PROFILE LOW FRONT SUSPENSION – FL SOFTAIL (54758-07 SHOWN)

A. PROFILE LOW FRONT SUSPENSION – FL SOFTAIL (54596-94 SHOWN)



A. PROFILE LOW FRONT SUSPENSION – FX SOFTAIL (54621-05 SHOWN)

B. PREMIUM RIDE CARTRIDGE FORK KIT



**\*WARNING:** The Profile Low Front Spring Kit cannot be used independently and must be used with the appropriate Profile Rear Shock Lowering Kit. Installation of any accessory suspension components may affect cornering clearance and jiffy stand operation. This could distract the rider, causing loss of control and death or serious injury.



**\*WARNING:** The Jiffy Stand included in the Front Suspension Kit is designed solely for use with this Harley-Davidson® Profile Suspension Kit and must be installed. This Jiffy Stand is not designed or intended for use in other applications. Improper application may affect jiffy stand operation. This could distract the rider, causing loss of control, resulting in death or serious injury.



**\*WARNING:** Installation of any accessory suspension components may affect cornering clearance and jiffy stand operation. This could distract the rider, causing loss of control and death or serious injury.

Notice: The prices appearing in this catalog are the manufacturer's suggested retail prices. Actual retail prices may vary.



# SOFTAIL® 269

Suspension



**C. PROFILE LOW REAR SUSPENSION – CHROME**

## C. PROFILE® LOW REAR SUSPENSION\*

This suspension lowers the seat height approximately 1.0" (P/N 54588-94) or .75" (P/N 54651-05 and 54652-05) while preserving ride quality. Spring and damping rates are tailored for Softail® models to ensure a controlled ride. Shocks feature multi-staged damping to ensure optimal performance under varying conditions. Kit includes a pair of rear shock absorbers and a Softail shock spring preload adjustment wrench. Compatible with Profile® Low Front Suspension.

Fits '00-later Softail models (except FXCW, FXCWC, FXS, FXSB, FXSBSE, FXSTD and FXSTSSE3). Does not lower '05-later FLS (except models in AUS, BRZ and APC markets), FLSTN, FLSTSB, FLSTFB, FLSTSE/2/3, '07 FXSTD and FXSTSSE/2/3 models. Also fits '10-later Fat Boy® Special model in UK, Europe, Brazil and select international markets that are factory-equipped with standard-height rear suspension.

<b>54651-05</b>	Chrome.	<b>\$409.95</b>
<b>54652-05</b>	Black.	<b>\$409.95</b>

Fits '89-'99 Softail models, including '97-'99 FLSTS.

<b>54588-94</b>	Chrome.	<b>\$409.95</b>
-----------------	---------	-----------------

## D. SHOCK ADJUSTMENT SPANNER

The Universal Spanner is small enough to carry in a H-D® Tool Kit and is designed to adjust the spring load on all mechanically adjustable H-D rear shock absorbers.

<b>94448-82B</b>		<b>\$11.95</b>
------------------	--	----------------

For use on models with mechanically adjustable H-D rear shock absorbers (except XR models).

## E. REAR LOWERING KIT\*

Provides low cost alternative to buying complete shocks. This kit is for the rider that simply wants to lower their bike inexpensively and have some ride height adjustability. Kit will lower seat height up to 1.0".

<b>54001-04A</b>		<b>\$104.95</b>
------------------	--	-----------------

Fits '00-later Softail models (except FLS, FLSTFB, FLSTN, FLSTNSE, FLSTSB, FXCW, FXCWC, FXS, FXSB, FXSBSE, FXSTD, FXSTSSE/2/3, FLSTFSE/2/3 and FLSTSE/2/3). Also fits '12-later FLS models in AUS, BRZ and APC markets. Does not fit models equipped with Profile Lowering Kits P/N 54651-05, 54588-94 or 54652-05.

## F. COMFORT FLEX REAR SHOCKS\*

For the rider willing to exchange the low-profile "slammed" look for improved ride comfort. Standard-length shocks raise the seat height of a factory-lowered bike approximately 1.0" and deliver an improved ride through a longer stroke. Spring rates and damping are tailored to ensure a controlled ride and optimal performance under varying conditions. Kit includes left and right rear shock absorbers and a pre-load adjustment wrench.

<b>54000041</b>		<b>\$304.95</b>
-----------------	--	-----------------

Fits '05-later FLS, FLSTFB, FLSTFSE/2, FLSTN, FLSTSB, FLSTSE/2/3, FXSTSSE/2, '03 FXSTDSE, '04 FXSTDSE2, '07 FXSTD and '14-later FLSTNSE. Stock on '00-later FL and FX models equipped with standard height rear shocks. Cannot be used on models equipped with Profile Low Front Suspension Kits.



**D. SHOCK ADJUSTMENT SPANNER**



**E. REAR LOWERING KIT**



**F. COMFORT FLEX REAR SHOCKS**



**\*WARNING:** Installation of any accessory suspension components may affect cornering clearance and jiffy stand operation. This could distract the rider, causing loss of control and death or serious injury.

Notice: The prices appearing in this catalog are the manufacturer's suggested retail prices. Actual retail prices may vary.

# 270 SOFTAIL®

## Foot Controls

### A. EXTENDED REACH FORWARD CONTROL KIT\*

This kit extends the rider foot controls a full 3.0" forward of the stock location, providing the tall rider a comfortable riding position. This comprehensive kit includes everything necessary for installation. The chrome kit includes new chrome brake and shifter mounting assemblies, chrome shift rod and all necessary hardware. Black kit includes new black painted brake and shifter mounting assemblies, chrome shift rod and all necessary hardware. The kit is compatible with Original Equipment or accessory footpegs, brake and shift lever and brake pedal and shifter peg.

Fits '07-'14 FX Softail® models (except FXSB, FXSBSE and FXSTD). FXCW, FXCWC and FXS models must reuse Original Equipment footpegs. Not for use with accessory Shift Linkages. Separate purchase of model-specific rear brake line is required. NOTE: Extended Forward Control Kit is compatible with Engine Guard P/N 49078-04A only.

<b>49171-08</b>	Chrome.	<b>\$499.95</b>
<b>49223-08</b>	Black.	<b>\$469.95</b>

#### Also available:

### EXTENDED REACH FORWARD CONTROL REAR BRAKE LINE

Required for installation of Extended Reach Forward Control Kit P/N 49171-08 or 49223-08.

Fits '11-'14 FX Softail models equipped with Extended Reach Forward Control Kit P/N 49171-08 or 49223-08.

<b>41800004</b>	With ABS Brakes.	<b>\$99.95</b>
<b>41800005</b>	Without ABS Brakes.	<b>\$99.95</b>
<b>44970-07</b>		<b>\$99.95</b>

Fits '07 FX Softail models (except FXSTD) equipped with Extended Reach Forward Control Kit P/N 49171-08 or 49223-08.

<b>44972-08</b>		<b>\$99.95</b>
-----------------	--	----------------

Fits '08-'10 FX Softail models equipped with Extended Reach Forward Control Kit P/N 49171-08 or 49223-08.



**A. EXTENDED REACH FORWARD CONTROL KIT – LEFT**



**A. EXTENDED REACH FORWARD CONTROL KIT – RIGHT**



**A. EXTENDED REACH FORWARD CONTROL KIT – CHROME**



**A. EXTENDED REACH FORWARD CONTROL KIT – BLACK**

### B. FORWARD CONTROL KIT FOR FL SOFTAIL® MODELS\*

Stretch out and put your feet in the wind. Ideal for taller riders, this kit converts the standard FL Softail footboard controls to Original Equipment FX Softail forward controls. The resulting foot-forward riding position takes the long-limbed rider out of the upright flat-foot, knees-up stance and puts them in a relaxed laid-back posture. Kit includes left and right brackets, shift lever, brake lever and all necessary mounting hardware. Footpegs and brake pedal pad sold separately.

<b>33909-08A</b>		<b>\$319.95</b>
------------------	--	-----------------

Fits '07-later FLSTC, FLSTF (except FLS and FLSTFB), FLSTN, FLSTSB and FLSTSC models. Requires separate purchase of appropriate footpeg kit. Compatible footpeg kits for FLSTC and FLSTF are P/N 50305-02, 50359-04, 50370-04, 50474-03, 50500-03, 50506-03, 50576-05, 50695-08 or 50935-07. FLSTN, FLSTSB and FLSTSC require separate purchase of stock FXCW footpegs with wear pegs (P/N 51327-08 Left Peg, 51323-08 Right Peg and 33130-07A Wear Peg (Qty 2)). Does not fit with Profile® Low Suspension.



**B. FORWARD CONTROL KIT FOR FL SOFTAIL MODELS**

### C. RIDER FOOTPEG HEEL REST

Give your feet a rest while you're stretching out on your forward controls. These adjustable Billet-Style Rider Footpeg Heel Rests reduce fatigue and make you look as good as you feel. Just add a pair of matching shifter pegs to complete the custom look (sold separately).

<b>50227-01</b>		<b>\$124.95</b>
-----------------	--	-----------------

Fits '93-'02 FXDWG and '89-later FX Softail models. Also fits Dyna® models equipped with Forward Control Kit P/N 49080-06A, 49021-09 or 49080-93A.



**C. RIDER FOOTPEG HEEL REST**



**\*WARNING:** Installation of this kit may affect cornering clearance. This could distract the rider, causing loss of control, resulting in death or serious injury.

Notice: The prices appearing in this catalog are the manufacturer's suggested retail prices. Actual retail prices may vary.





**D. BILLET STYLE SHIFT LEVER – CHROME**



**E. BILLET STYLE REAR BRAKE LEVER – CHROME**



**D. BILLET STYLE SHIFT LEVER – EDGE CUT**



**E. BILLET STYLE REAR BRAKE LEVER – EDGE CUT**



**D. BILLET STYLE SHIFT LEVER – SATIN BLACK**



**E. BILLET STYLE REAR BRAKE LEVER – SATIN BLACK**



**F. REAR MASTER CYLINDER KIT – CHROME**



**G. REAR MASTER CYLINDER COVER – CHROME**

### D. BILLET STYLE SHIFT LEVERS

Styled to complement our billet style mirror stems, these Billet Style Shift Levers are forged from 6061-T6 aluminum, then machined and polished for a beautiful, custom look. Available in your choice of mirror chrome, satin black powder coat or edge cut black anodized and machined aluminum finishes. Includes chrome hardware. Shift pegs sold separately.

Fits '91-later Dyna® (except '14-later FXDL or models equipped with Further Forward Mid-Control Kit P/N 50500386) and '90-later FX Softail® models.

<b>34539-00</b>	Chrome.	<b>\$89.95</b>
<b>34043-10</b>	Edge Cut.	<b>\$89.95</b>
<b>34016-08</b>	Satin Black.	<b>\$89.95</b>

### E. BILLET STYLE REAR BRAKE LEVERS

Styled to complement our billet style mirror stems and hand and foot controls, these slotted Rear Brake Levers are forged from 2014-T6 aluminum, then machined and polished for a beautiful, custom look. Available in your choice of mirror chrome, satin black powder coat or edge cut black anodized and machined aluminum finishes. Brake pedal pads sold separately.

Fits '07-later FX Softail models (except FXSBSE).

<b>42632-07</b>	Chrome.	<b>\$169.95</b>
<b>40084-10</b>	Edge Cut.	<b>\$169.95</b>
<b>41805-08</b>	Satin Black.	<b>\$169.95</b>

### F. REAR MASTER CYLINDER KIT – CHROME

Dress your foot controls in brilliant chrome. This kit replaces the black painted rear master cylinder with a polished and plated version, manufactured from Original Equipment components for proper fit and function. The kit includes the mirror-finish master cylinder body, matching chrome master cylinder cover and polished cover hardware.

<b>41777-05A</b>		<b>\$169.95</b>
Fits '06-later Softail and '05-'07 Touring models.		
<b>41775-04B</b>		<b>\$169.95</b>
Fits '99-'04 Touring models and '00-'05 Softail models.		

### G. REAR MASTER CYLINDER COVER – CHROME

An easy way to add chrome to your bike is with this chrome-plated version of the stock master cylinder cover.

<b>46425-05A</b>		<b>\$39.95</b>
Fits '06-later Dyna non-ABS models, Softail and '05-'07 Touring models.		
<b>45149-99C</b>		<b>\$39.95</b>
Fits '00-'05 Softail and '99-'04 Touring models.		

# 272 SOFTAIL®

## Foot Controls

### A. BILLET STYLE REAR BRAKE LEVER – EXTENDED REACH

Ride tall in the saddle. This Billet Style Brake Lever features a 1.0" longer arm than the Original Equipment brake lever, allowing the tall rider to stretch the leg and straighten the knee for added comfort and control. The additional room also provides riders with large boot sizes ample room to move and reposition their feet on the footboard. Styled to complement our billet style mirror stems, these Billet Style Brake Levers are forged, machined and polished for a beautiful, custom look. When combined with the available Extended Reach Shift Lever, long-limbed riders can straighten their legs and ride in comfort. Brake pedal pads sold separately.

**41600008** Chrome. **\$169.95**  
Fits '00-later FL Softail® models. Will not fit with Rear Master Cylinder Cover P/N 41815-00.

### B. BILLET STYLE REAR BRAKE LEVER – REDUCED REACH

Ideal for those with small feet or a short inseam, these highly styled brake levers are over 2.0" shorter than late model Original Equipment FL Softail levers. The billet styling complements our billet style mirrors and shift levers and are forged from 2014-T6 aluminum, then machined and chrome-plated. Lever matches the length of the Original Equipment standard length lever found on '87-'99 FL Softail motorcycles. Brake Pedal Pads sold separately.

**42640-00** Chrome. **\$169.95**  
Fits '00-later FL Softail models.

### C. BILLET STYLE REAR BRAKE LEVER

Styled to complement our billet style mirror stems and shift levers, these Billet Style Rear Brake Levers are forged from billet aluminum, then machined and polished for a beautiful, custom look. Available in your choice of mirror chrome, satin black powder coat or edge cut black anodized and machined aluminum finishes. Lever matches the length of the Original Equipment extended length lever found on late-model FL Softail motorcycles. Brake pedal pads sold separately.

Fits '00-later FL Softail models. Will not fit with Rear Master Cylinder Cover P/N 41815-00.

**42640-03** Chrome. **\$169.95**

**40079-10** Edge Cut. **\$169.95**

**41800-08** Satin Black. **\$169.95**

Fits '87-'99 FLSTC, FLSTS, FLSTF and FLSTN models and '97-'07 Touring models.

**42638-00A** Chrome. **\$169.95**



**BRAKE LEVER COMPARE – '00-LATER FL SOFTAIL MODELS**



**A. BILLET STYLE REAR BRAKE LEVER – EXTENDED REACH**



**B. BILLET STYLE REAR BRAKE LEVER – REDUCED REACH**



**C. BILLET STYLE REAR BRAKE LEVER – CHROME**



**C. BILLET STYLE REAR BRAKE LEVER – EDGE CUT**



**C. BILLET STYLE REAR BRAKE LEVER – SATIN BLACK**

*Notice: The prices appearing in this catalog are the manufacturer's suggested retail prices. Actual retail prices may vary.*



# SOFTAIL® 273

## Foot Controls



SHIFT LEVER COMPARE



D. BILLET STYLE HEEL/TOE SHIFT LEVER – EXTENDED REACH

### D. BILLET STYLE HEEL/TOE SHIFT LEVER – EXTENDED REACH

Stretch out in style. Both the heel and toe sections of this Shift Lever are 1.0" longer than traditional levers, separating the distance between the heel/toe shift by 2.0" total. This added space provides a comfortable riding position for a tall rider and allows a rider with a large boot extra room to move. Styled to complement our billet style mirror stems, these Billet Style Shift Levers are forged, machined and polished for a beautiful, custom look. When combined with the available Extended Reach Brake Lever, long-limbed riders can straighten their legs and ride in comfort. Kit includes a front and rear lever and mounting hardware.

**33600001** Chrome. **\$149.95**  
Fits '86-later FL Softail®, '88-later Touring and '08-later Trike models.

### E. BILLET STYLE HEEL/TOE SHIFT LEVER – STANDARD LENGTH

Styled to complement our billet style mirror stems, these Billet Style Shift Levers are forged from 7075-T6 aluminum, then machined and polished for a beautiful, custom look. Available in your choice of mirror chrome, satin black powder coat or edge cut black anodized and machined aluminum finishes. Kit includes a front and rear lever and chrome hardware.

Fits '86-later FL Softail, '88-later Touring and '08-later Trike models.

**34535-00B** Chrome. **\$149.95**  
**34045-10** Edge Cut. **\$149.95**  
**34023-08** Satin Black. **\$149.95**



E. BILLET STYLE HEEL/TOE SHIFT LEVER – STANDARD LENGTH, CHROME



E. BILLET STYLE HEEL/TOE SHIFT LEVER – STANDARD LENGTH, EDGE CUT

### F. FOLDING HEEL SHIFTER

Give your left foot a little extra room. Folding Heel Shifter permits the rider to move the rear shift peg out of the way when on the open road, while retaining heel/toe shift functionality around town. Positive detent holds the peg in the selected position and can be adjusted while riding. Easy to install, the replacement rear lever is chrome-plated and shaped to match the Original Equipment toe shift lever. Lever accepts stock or accessory shifter peg.

**33876-07** **\$79.95**  
Fits '86-later FL Softail, '88-later Touring and '08-later Trike models.



E. BILLET STYLE HEEL/TOE SHIFT LEVER – STANDARD LENGTH, SATIN BLACK



F. FOLDING HEEL SHIFTER

Notice: The prices appearing in this catalog are the manufacturer's suggested retail prices. Actual retail prices may vary.

## 274 SOFTAIL®

### Foot Controls

#### A. CUSTOM GEAR SHIFT LINKAGES

Kick your custom into gear with this collection of high quality custom shift linkages. Available in a variety of designs to match your bike's style, these linkages feature aircraft-quality rod ends for easy adjustment and smooth operation. The linkage kit includes a transmission lever cover and decorative acorn nuts and bolts for a complete custom look. Easy to install.

Fits '86-later Softail®, Touring and Trike models. (Does not fit '97-'99 FLSTS models or models equipped with Softail Extended Reach Forward Controls.)

1. 33900134	Silencer Brushed Nickel.	\$129.95
2. 33915-09	Diamond Black.	\$129.95
3. 34018-08	Slotted Black Anodized.	\$129.95
4. 34850-09	Skull.	\$129.95
5. 33854-09	Fat Boy® Scripted.	\$129.95
6. 33840-09	Flame.	\$149.95
7. 33801-09	Harley-Davidson Scripted.	\$129.95
8. 33762-09	Ball-Milled with Bar & Shield Logo.	\$129.95
9. 33760-09	Slotted with Bar & Shield Logo.	\$129.95
10. 33884-09	Smooth with Bar & Shield Logo.	\$109.95
11. 33823-09	Tribal.	\$149.95
12. 33814-98A	Round.	\$89.95



A. CUSTOM GEAR SHIFT LINKAGE – SILENCER BRUSHED NICKEL SHOWN



A. CUSTOM GEAR SHIFT LINKAGES

*Notice: The prices appearing in this catalog are the manufacturer's suggested retail prices. Actual retail prices may vary.*



# SOFTAIL® 275

Foot Controls



**B. GEAR SHIFTER LINKAGE COVER – “HARLEY-DAVIDSON” SCRIPT**

## B. GEAR SHIFTER LINKAGE COVERS

A simple and inexpensive way to detail your Softail® model. These easy-to-install chrome-plated covers conceal the stock shifter linkage for a brilliant finish. Kit includes all necessary mounting hardware.

Fits '99-later Softail models (except FLSTSE) with stock shifter linkage.

<b>1. 46300-01</b>	Diamond.	<b>\$45.95</b>
<b>2. 46302-01</b>	“Harley-Davidson” Script.	<b>\$42.95</b>
<b>3. 46304-01</b>	Engraved “Harley-Davidson”.	<b>\$42.95</b>

## C. HEEL/TOE SHIFTER SHAFT COVER

Conceal the splined end of the shifter shaft when you remove the heel shift lever. The easy-to-install chrome-plated aluminum billet cap is held in place with a flush Allen® screw for a clean look.

**35471-05** **\$18.95**

Fits '82-later FL Softail, Touring and Trike models equipped with heel/toe shift levers. Installation requires removal of heel shift lever.

## D. HEEL/TOE SHIFTER SHAFT COVER WITH INSERT

Conceal the splined shifter shaft when you remove the heel shift lever. The kit includes a cover for the shaft end and an insert that conceals the casting and nylon spacer inboard of the shift lever. Manufactured from billet aluminum, these easy-to-install chrome-plated covers are held in place with flush Allen screws for a clean appearance.

**35495-06** **\$34.95**

Fits '00-later FL Softail models (except FLSTSE) equipped with heel/toe shift levers. Installation requires removal of heel shift lever.



**B. GEAR SHIFTER LINKAGE COVERS**



**C. HEEL/TOE SHIFTER SHAFT COVER**



**D. HEEL/TOE SHIFTER SHAFT COVER WITH INSERT**

*Notice: The prices appearing in this catalog are the manufacturer's suggested retail prices. Actual retail prices may vary.*

# 276 SOFTAIL®

## Foot Controls

### A. EXTENDED LENGTH RIDER RUNNING BOARDS

Stretching your legs and moving your feet during a long ride relieves muscle tension and reduces rider fatigue. At 4.0" longer (1.0" in front, 3.0" in back) and .5" wider than the Original Equipment rider footboards, these ergonomically friendly Running Boards provide plenty of space for riders to reposition their feet for maximum comfort. When used in conjunction with available Extended Brake and Shift Levers, the long legged rider will have even more room to stretch out on long rides. The easy-to-install kit includes left and right footboard pans with vibration-isolated inserts that are styled to complement the Crested Bar & Shield controls collection or most other chrome and rubber collections.

**50500158** Chrome. **\$199.95**  
Fits '00-later FL Softail® (except FLS, FLSTFB, FLSTN, FLSTNSE, FLSTSE/2), '00-later Touring (except FLHTKL and FLHTCUL) and '09-'13 Trike models. Not for use with Jiffy Stand Kit P/N 5000000 or Jiffy Stand Extension Kit P/N 50233-00, 50000008 and 50000023.



A. EXTENDED LENGTH  
RIDER RUNNING BOARDS

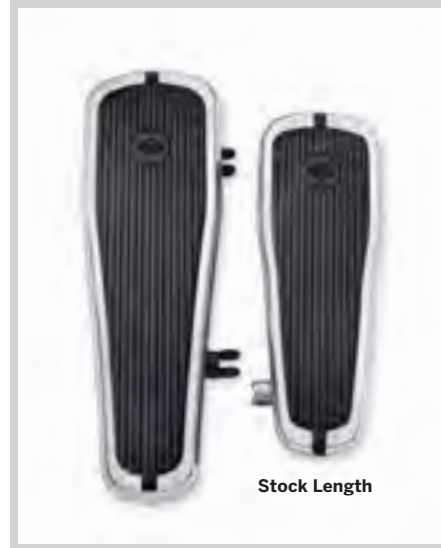

A. EXTENDED LENGTH RIDER RUNNING  
BOARDS – COMPARISON TO STOCK SIZE

### B. HALF-MOON RIDER FOOTBOARDS

Combine the style of the '40s with the comfort of today. The classic half moon-shaped rider footboards are available in polished stainless steel or gloss black finish to complement your styling direction. The traditional "Harley-Davidson" rubber insert features a vibration-isolation design for a long, comfortable ride. Kit includes left and right footboard pans and matching rubber inserts.

Fits '86-later FL Softail models.

**51345-08** Polished Stainless. **\$149.95**

**51400-08** Gloss Black. **\$149.95**



B. HALF-MOON RIDER FOOTBOARDS –  
POLISHED STAINLESS



B. HALF-MOON RIDER FOOTBOARDS –  
GLOSS BLACK

### C. RIDER FOOTBOARD HEEL GUARD

Avoid damaged boots and hours of cleaning melted rubber scuff marks from your exhaust shield. This Heel Guard mounts to the right-side rider footboard and protects your boot from contact with the hot exhaust shield. The subtle curved shape keeps the boot heel away without restricting fore-and-aft movement of the rider's foot. Kit includes chrome guard with cutaway Bar & Shield logo and all mounting hardware.

**50500225** **\$64.95**  
Fits '12-later FLD, '86-later FL Softail, '86-later Touring and '09-later Trike models equipped with Traditional and Swept Wing footboards. Does not fit models equipped with Half-Moon, Tapered or Burst footboards, Extended Reach Rider Footboards P/N 50409-04 or 54145-10, Rider Running Boards P/N 50500158 or Screamin' Eagle® Fat Exhaust Shield Kits.



C. RIDER FOOTBOARD HEEL GUARD



D. RIDER FOOTBOARD BRACKETS – CHROME

### D. RIDER FOOTBOARD BRACKETS – CHROME

Complete the custom transformation by replacing the stock painted footboard brackets with brilliant chrome. This kit is manufactured with Original Equipment components for proper fit and polished and plated for a finished look. Kit includes chrome mounting hardware.

**33698-07** **\$349.95**  
Fits '07-'10 FLSTC, FLSTF, FLSTFB, FLSTN, FLSTSC and FLSTSB models.

*Notice: The prices appearing in this catalog are the manufacturer's suggested retail prices. Actual retail prices may vary.*



# SOFTAIL® 277

## Foot Controls



**E. REAR MASTER CYLINDER COVER – FL SOFTAIL**



**F. GEAR SHIFT CONTROL COVER KIT – FL SOFTAIL**

**E. REAR MASTER CYLINDER COVER – FL SOFTAIL**

The distinctive styling of our Gear Shift Control Cover P/N 33825-00 is carried over to this chrome-plated Rear Master Cylinder Cover. Designed for easy installation.

**41815-00** **\$69.95**  
Fits '00-'06 FL Softail® models. Does not fit with Billet Brake Lever P/N 42640-03.

**F. GEAR SHIFT CONTROL COVER KIT – FL SOFTAIL**

Sweeping radius lines and chrome-plating give this Gear Shift Control Cover distinctive styling. Designed for easy installation. (Shown without toe-shift lever for clarity.)

**33825-00** Fits '00-'06 FL Softail models. **\$69.95**

**G. PASSENGER FOOTPEG SUPPORTS – CHROME**

Polished and plated to a mirror-finish, this chrome version of the Softail Deluxe Original Equipment black passenger footpeg support complements any of the available passenger footpeg kits. When added to Softail Deuce™ and Fat Boy® models, this kit extends the passenger footpegs to allow folding without contacting the exhaust system.

**51039-05** **\$129.95**  
Fits '07-later Softail models (except FLSTSC), '05-later FLSTN models and '00-'06 FXSTD, FXS and FLSTF models with the separate purchase of (1) Screw P/N 4032A and (1) Screw P/N 4519. Also fits FXCW models with the additional purchase of (2) Screw P/N 4454 and (2) Spring Washer P/N 50912-72. Also fits FLS models with separate purchase of (1) Passenger Footpeg Mount Kit P/N 50932-08.



**G. PASSENGER FOOTPEG SUPPORTS – CHROME**



**H. PASSENGER FOOTPEG MOUNT KIT**

**H. PASSENGER FOOTPEG MOUNT KIT**

A necessary addition when converting your solo seat FLSTSB Cross Bones® model to a two-up passenger-carrying ride. Kit includes black mounting brackets and all necessary mounting hardware. Footpegs sold separately.

**50932-08** **\$54.95**  
Fits '12-later FLS and '08-'11 FLSTSB models.

**I. PASSENGER FOOTBOARD SUPPORT KIT**

Required for installation of Mini Footboards in the passenger position on many Softail motorcycles.

**50454-09** **\$54.95**  
Required for installation of Mini Footboards P/N 50451-09, 50500109, 50500124, 50500139, 50500144 on '08-later Softail models. Does not fit FLSTF, FLSTFB, FLSTN, FLSTSB, FXS, FXSBSE, FXSTD and Softail models with shotgun exhaust. FLSTC and FLSTS models require the separate purchase of Saddlebag Bracket Relocation Kit P/N 90238-00.



**I. PASSENGER FOOTBOARD SUPPORT KIT**



**J. MINI FOOTBOARD KIT**

**J. MINI FOOTBOARD KIT**

This Mini Footboard Kit can be installed in place of traditional footpegs and provides a little additional leg support and more options to move your feet around on a long run. Mini Footboards mount to standard H-D® style footpeg supports, and can be used in many rider and passenger applications. A little larger than a bicycle pedal, footboards can be pivoted to the proper angle for maximum riding comfort. The sole-gripping horizontal black rubber bands complement the mirror-chrome finish and add vibration isolation and a rich appearance to the pegs. Complete the look with Shifter Pegs and Brake Pedal Pads from the Chrome and Rubber Collection.

**Fits rider position:**  
VRSC™ models with forward controls (except VRSCDX and VRSCF), '06-earlier XL, '07-'10 XL883, XL883R, XL883C, XL1200C, XL1200R and '07-'11 XL1200L, Dyna® models (except FLD), and Softail models with forward controls (except FXCW, FXCWC, FXS, FXSB, or FXSBSE).

**Fits passenger position:**  
All models with H-D male-mount passenger peg mounts (except '06-earlier VRSC, '03-earlier XL, '05-earlier Dyna and Softail models equipped with Shotgun exhaust). Softail models require separate purchase of Support Kit PN 50454-09.

**Fits highway peg position:**  
All models with frame-mount or engine guard-mount highway pegs (except Whiskers Adjustable Highway Bar P/N 50855-09 and 50865-09).

**50451-09** **\$109.95**

Notice: The prices appearing in this catalog are the manufacturer's suggested retail prices. Actual retail prices may vary.

# 278 SOFTAIL®

## Foot Controls

### A. CRESTED BAR & SHIELD PASSENGER FOOTBOARD AND MOUNT KIT

Styled to match the rider footboards on the Softail® Deluxe model, these Tapered Passenger Footboards feature a crested Bar & Shield logo rubber pad surrounded by a chrome accent. The footboard pan is chrome-plated throughout to add a custom touch, even in the folded position. Designed for convenient bolt-on installation, the complete kit includes aluminum footboards, rubber pads, mounting hardware and black footboard supports.

**50377-07A** \$329.95

Fits '07-later FLS, FLSTN and FLSTSB models. Not for use with Pivot Bolt Covers or Chrome Rear Saddlebag Guards P/N 49360-08.



A. CRESTED BAR & SHIELD PASSENGER FOOTBOARD AND MOUNT KIT



A. CRESTED BAR & SHIELD PASSENGER FOOTBOARD AND MOUNT KIT

### B. PASSENGER FOOTBOARD AND MOUNT KITS

Add passenger comfort and support. These complete kits include specially designed mounting stud/brackets for convenient bolt-on installation. Footboards fold up when not in use. Available in your choice of Original Equipment or mirror-chrome finish, these kits include footboard pans, rubber pads, mounting hardware and matching chrome or black footboard supports. NOTE: Passenger Footboard Kits cannot be used with Pivot Bolt Covers.

Fits '00-later Softail models (except FLS, FLSTF, FLSTFB, FLSTN, FLSTNSE, FLSTS, FLSTSB, FLSTSC, FLSTSE/2/3, FXS, FXSBSE, FXCW, FXCWC and FXSTD). FLSTC models require Saddlebag Bracket Relocation Kit P/N 90238-00.

**50602-00A** Black. \$254.95

**52715-04A** Chrome. \$399.95

Fits '86-'99 Softail models (except FLSTS, FLSTF and FLSTN). NOTE: '90-'99 FLSTC models require Saddlebag Bracket Relocation Kit P/N 90345-90A.

**50602-89B** Clear Coat Aluminum. \$249.95



B. PASSENGER FOOTBOARD AND MOUNT KIT – BLACK



B. PASSENGER FOOTBOARD AND MOUNT KIT – CHROME

### C. PASSENGER FOOTBOARD SUPPORT KITS

Add the comfort and convenience of passenger footboards to your Softail motorcycle. These support kits are designed to allow installation of traditional D-shaped, Swept Wing, Tapered or Old-Style Passenger Footboards (sold separately) on Softail models. Kit includes left and right supports, footboard mount hinge pins and installation hardware.

Fits '00-later Softail models (except FLS, FLSTF, FLSTFB, FLSTN, FLSTNSE, FLSTS, FLSTSB, FLSTSC, FLSTSE/2/3, FXS, FXSBSE, FXCW, FXCWC and FXSTD). FLSTC models require Saddlebag Bracket Relocation Kit P/N 90238-00.

**50460-06** Chrome. \$249.95

**50459-06** Black. \$149.95

Fits '07-later FLSTF, FLSTFB, FXS and FXSTD models.

**50399-07A** Black. \$139.95

Fits '07-later FLS, FLSTN and FLSTSB models. Not for use with Pivot Bolt Covers or Chrome Rear Saddlebag Guards P/N 49360-08.

**50400-07A** Black. \$139.95



C. PASSENGER FOOTBOARD SUPPORT KIT – BLACK



C. PASSENGER FOOTBOARD SUPPORT KIT – CHROME

Notice: The prices appearing in this catalog are the manufacturer's suggested retail prices. Actual retail prices may vary.



# SOFTAIL® 279

Foot Controls



**D. HALF-MOON PASSENGER FOOTBOARD PANS – CHROME**



**D. HALF-MOON PASSENGER FOOTBOARD PANS – GLOSS BLACK**

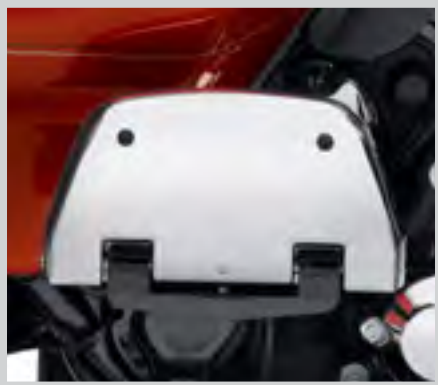

**E. CHROME PASSENGER FOOTBOARD PANS**



**F. WILLIE G SKULL PASSENGER FOOTBOARD COVERS**



**G. CONCHO PASSENGER FOOTBOARD COVERS**



**H. V-LOGO PASSENGER FOOTBOARD COVERS**



**I. ROAD KING CLASSIC PASSENGER FOOTBOARD COVERS**



**J. HARLEY-DAVIDSON SCRIPT PASSENGER FOOTBOARD COVERS**

## D. HALF-MOON PASSENGER FOOTBOARD PANS AND INSERTS

Styled to match the Half-Moon Rider Footboards, these classic passenger footboards add both style and comfort to your nostalgic ride. Available in mirror-chrome or gloss black finish, the kit includes left and right footboard pan and vibration-isolation footboard inserts. Model-specific footboard mounts are sold separately.

Fits '86-later Touring, '00-later Softail® and '06-later Dyna® models equipped with passenger footboard supports. Does not fit Trike models.

<b>50807-08</b>	Chrome.	<b>\$189.95</b>
<b>50810-08</b>	Gloss Black.	<b>\$179.95</b>

## E. CHROME PASSENGER FOOTBOARD PANS

Replace the factory black painted passenger footboard with the custom look of smooth chrome. The kit includes left- and right-hand traditional D-shaped footboard pans, chrome-plated and ready to install with your Original Equipment hardware. Just add your choice of footboard insert for the finishing touch. Footboard supports sold separately.

**50752-04** **\$169.95**  
Fits '86-later Touring and Trike, '00-later Softail and '06-later Dyna models equipped with passenger footboard supports.

## F. WILLIE G SKULL PASSENGER FOOTBOARD COVERS

Chrome-plated steel footboard cover disguises the Original Equipment passenger footboard and features a three-dimensional sculptured medallion with the "Harley-Davidson" skull logo. This easy-to-install kit includes all required mounting hardware.

**50836-07** **\$79.95**  
Fits '87-later Touring and Trike models, '86-later FL Softail models and '06-later Dyna models equipped with traditional D-shaped aluminum passenger footboards.

## G. CONCHO PASSENGER FOOTBOARD COVERS

Heritage Softail® Classic-inspired conchos make these covers look great whether footboards are up or down.

**50193-96** **\$79.95**  
Fits '87-later Touring and Trike models, '86-later FL Softail models and '06-later Dyna models equipped with traditional D-shaped aluminum passenger footboards.

## H. V-LOGO PASSENGER FOOTBOARD COVERS

V-Logos are die-cast aluminum integrated with the cover, then chrome-plated for a desirable shine. Includes all mounting hardware.

**50194-96** **\$65.95**  
Fits '87-later Touring and Trike models, '86-later FL Softail models and '06-later Dyna models equipped with traditional D-shaped aluminum passenger footboards.

## I. ROAD KING® CLASSIC PASSENGER FOOTBOARD COVERS

The latest in the family of Road King® Classic inspired accessories, this chrome-plated steel footboard cover features a chrome die-cast Road King Classic medallion with black accents and a stylish leather accent piece. Mounting hardware included.

**50246-00** **\$79.95**  
Fits '87-later Touring and Trike models, '86-later FL Softail models and '06-later Dyna models equipped with traditional D-shaped aluminum passenger footboards.

## J. HARLEY-DAVIDSON SCRIPT PASSENGER FOOTBOARD COVERS

Easy installation using chrome hardware.

**50782-91** **\$65.95**  
Fits '87-later Touring and Trike models, '86-later FL Softail models and '06-later Dyna models equipped with traditional D-shaped aluminum passenger footboards.

*Notice: The prices appearing in this catalog are the manufacturer's suggested retail prices. Actual retail prices may vary.*

# 280 SOFTAIL®

## Engine Guards

### A. FRONT ENGINE GUARD KIT – CHROME\*

Protect your bike without sacrificing ground clearance or style. The one-piece engine guard is designed to complement the lines of the motorcycle and the bright chrome finish adds the perfect finishing touch.

**49004-00A** **\$214.95**

Fits '00-later FL Softail® models.

**49200-07A** **\$214.95**

Fits '00-later FX Softail models (except models equipped with Extended Reach Forward Control Kit P/N 49171-04 or 49223-04).

**49004-90** **\$234.95**

Fits '86-'99 FL Softail models.

**49016-72D** **\$234.95**

Fits '84-'99 FXST, FXSTC, FXSTS and FXSTSB, '80-'86 FXWG and '72-'85 FX models (except models equipped with Harley-Davidson® Extended Reach Forward Controls). (Does not fit FLSTS.)

**49078-04A** **\$214.95**

Fits '00-later FX Softail models equipped with Extended Reach Forward Control Kit P/N 49171-04, 49223-04, 49171-08 or 49223-08.



A. FRONT ENGINE GUARD KIT – CHROME

### B. ENGINE GUARD KIT – GLOSS BLACK\*

A serious finish for serious riders. Before a black powder coat, these engine guards get an extra layer of protection from an E-Coat dip. So go on and install Engine Guard Mount Footpegs because this finish will go the distance.

**49023-02A** **\$214.95**

Fits '00-later FL Softail models.



B. ENGINE GUARD KIT – GLOSS BLACK

### C. SOFT LOWERS

Extend your riding season. Full coverage Soft Lowers provide wind and mud protection for the rider's legs and boots and minimize cold updrafts as the weather changes. Covers are custom shaped to hug the engine guard to minimize flapping and they simply clip in place for speedy installation as the weather changes. Two-way zippered outer edge accommodates guard-mounted highway pegs in almost any position. Reflective piping provides added visibility and the rigid inner panel provides ample clearance around the foot controls.

**57100213** **\$109.95**

Fits FL Softail models equipped with Engine Guard P/N 49004-90 or 49004-00A. Does not fit Mustache or Nostalgic Engine Guards. Does not fit models with forward controls, Extended Reach Brake Lever or Extended Reach Shift Lever.



C. SOFT LOWERS



C. SOFT LOWERS



**\*WARNING:** Engine guards may provide limited leg and cosmetic vehicle protection under unique circumstances (fall over while stopped, very low speed slide). They are not made nor intended to provide protection from bodily injury in a collision with another vehicle or any other object.

Notice: The prices appearing in this catalog are the manufacturer's suggested retail prices. Actual retail prices may vary.



# SOFTAIL® 281

## Engine Guards



D. MUSTACHE ENGINE GUARD – CHROME



D. MUSTACHE ENGINE GUARD – GLOSS BLACK



E. NOSTALGIC CURVED ENGINE GUARD

### D. MUSTACHE ENGINE GUARD\*

Combine classic shape and modern function for a unique twist on engine protection. The flow of this engine guard complements the bike's traditional style while the gracefully curved upper section incorporates highway pegs into the shape. The integrated rubber pads offer a comfortable and slip-resistant cushion for your feet while traveling the open road. One-piece engine guard kit includes all required mounting hardware.

Fits '00-later FL Softail® models.

<b>49140-05B</b>	Chrome.	<b>\$269.95</b>
<b>49440-10</b>	Gloss Black.	<b>\$269.95</b>

### E. NOSTALGIC CURVED ENGINE GUARD\*

The nostalgic curved shape adds classic style to functionality. Reminiscent of the vintage 1940s style, the one-piece chrome Engine Guard complements the lines of the classic style Softail Deluxe, Heritage Softail® Classic and FL Springer™ models.

<b>49037-05A</b>	Chrome.	<b>\$214.95</b>
------------------	---------	-----------------

Fits '00-later FL Softail models. Compatible with Engine Footpeg Mount Kit P/N 49102-86T or 49144-86.



**\*WARNING:** Engine guards may provide limited leg and cosmetic vehicle protection under unique circumstances (fall over while stopped, very low speed slide). They are not made nor intended to provide protection from bodily injury in a collision with another vehicle or any other object.



**\*WARNING:** Do not use engine guard footpegs under normal stop and go operating conditions. Doing so could result in death or serious injury.



**\*WARNING:** Do not use highway pegs under normal stop and go operating conditions. Doing so could result in death or serious injury.

Notice: The prices appearing in this catalog are the manufacturer's suggested retail prices. Actual retail prices may vary.

## 282 SOFTAIL®

Highway Pegs

### A. WHISKERS ADJUSTABLE HIGHWAY BAR\*

Stretch your legs and change riding position while you rack up the miles. Frame-mounted bar can be pivoted fore and aft to accommodate your inseam length and locks in place with a common Allen® wrench. The easy-to-install bar features a three-point mounting system that grips both down tubes. Highway Bar accepts your choice of H-D® style male-mount footpegs (sold separately). Available in mirror-chrome or gloss black finish.

Fits '00-later Softail® models (except FXCW, FXCWC, FXS, FXSB and FXSBSE) without ABS. Also fits '14-later FLSTNSE when Original Equipment engine guard is removed. Does not fit with Boom!™ Audio Cruiser Amp and Speaker Kit P/N 76262-08, 76320-08, 76321-09, Heel Raiser Footpeg Kit P/N 50178-09 or Mini Footboard Kits P/N 50500109, 50500124, 50500139, 50500144 or 50451-09.

<b>50855-09</b>	Chrome.	<b>\$199.95</b>
<b>50865-09</b>	Gloss Black.	<b>\$199.95</b>

### B. MINI FOOTBOARD KIT

This Footboard Kit can be installed in place of traditional footpegs and provides a little additional leg support and more options to move your legs around on a long ride. Mini Footboards mount to the standard H-D style footpeg supports and can be used in many rider, passenger and highway peg applications. Sole-gripping rubber complements Original Equipment or accessory footboards and footpegs and adds vibration isolation and a rich appearance.

#### Fits rider position:

VRSC™ models with forward controls (except VRSCDX and VRSCF), '06-earlier XL, '07-'10 XL883, XL883R, XL883C, XL1200C, XL1200R and '07-'11 XL1200L, Dyna® models (except FLD), and Softail models with forward controls (except FXCW, FXCWC, FXS, FXSB, or FXSBSE).

#### Fits passenger position:

All models with H-D male-mount passenger peg mounts (except '06-earlier VRSC, '03-earlier XL, '05-earlier Dyna and Softail models equipped with Shotgun exhaust). Softail models require separate purchase of Support Kit PN 50454-09.

#### Fits highway peg position:

All models with frame-mount or engine guard-mount highway pegs (except Whiskers Adjustable Highway Bar P/N 50855-09 and 50865-09).

<b>50500139</b>	Small 3" – Chrome.	<b>\$129.95</b>
<b>50500144</b>	Small 3" – Gloss Black.	<b>\$129.95</b>
<b>50500109</b>	Large 4" – Chrome.	<b>\$129.95</b>
<b>50500124</b>	Large 4" – Gloss Black.	<b>\$129.95</b>



A. WHISKERS ADJUSTABLE HIGHWAY BAR – CHROME



A. WHISKERS ADJUSTABLE HIGHWAY BAR – GLOSS BLACK



A. WHISKERS ADJUSTABLE HIGHWAY BAR



B. MINI FOOTBOARD KIT



**\*WARNING:** Do not use engine guard footpegs under normal stop and go operating conditions. Doing so could result in death or serious injury.



**\*WARNING:** Do not use highway pegs under normal stop and go operating conditions. Doing so could result in death or serious injury.

Notice: The prices appearing in this catalog are the manufacturer's suggested retail prices. Actual retail prices may vary.



# SOFTAIL® 283

Highway Pegs & Jiffy Stands



**C. BILLET ENGINE GUARD FOOTPEG MOUNTING KIT – CHROME**



**C. BILLET ENGINE GUARD FOOTPEG MOUNTING KIT – GLOSS BLACK**

## C. BILLET ENGINE GUARD FOOTPEG MOUNTING KIT\*

Here's a stylish way to get your feet into the wind. This beautifully polished billet aluminum Footpeg Mount Kit installs easily on your engine guard and lets you stretch your legs on cross-country rides. Available in your choice of chrome or gloss black finishes. Works with all H-D® style male-mount footpegs.

Fits front engine guards with 1.25" diameter tubing (except VRSC™ Engine Guard P/N 49267-01A, 49388-09, XL Engine Guard P/N 49060-04, 49287-11, 49215-07 or Softail® Nostalgic Engine Guard P/N 49037-05A). Requires separate purchase of Chrome Bullet Tip Footpeg Bolt Kit P/N 94133-01.

<b>50957-02B</b>	Chrome.	<b>\$99.95</b>
<b>54234-10</b>	Gloss Black.	<b>\$99.95</b>

## D. JIFFY STAND EXTENSION

Jiffy Stand Extension kits have been ergonomically designed to simplify the deployment and retraction of the jiffy stand. The extension is shaped to simplify locating the tab with your boot and aid in swinging the jiffy stand into position. The move feels natural and adds confidence when parking your motorcycle in a tight spot. Kit mounts to Original Equipment jiffy stand and includes all required mounting hardware.

**50000008** **\$44.95**

Fits '07-later Softail models (except FLS, FLSTN, FLSTNSE, FXSB, FXSBSE, FXSTSSE3, FLTSE/2/3 and '10-later FLSTFB).

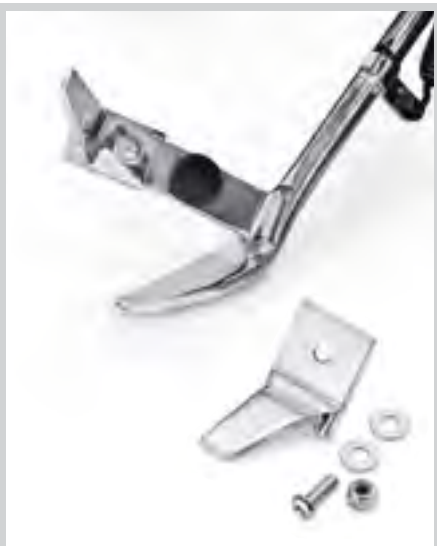

**D. JIFFY STAND EXTENSION**



**E. ERGO JIFFY STAND**

## E. ERGO JIFFY STAND

This Ergonomic Jiffy Stand has been engineered to simplify the deployment and retraction of the side stand. The jiffy stand features a ball-tipped extension that is shaped to simplify locating the tab with your boot and aid in swinging the jiffy stand into position. The move feels natural and adds confidence when parking your motorcycle in a tight spot. Kit replaces Original Equipment jiffy stand and includes stand bumper, bushing and all required mounting hardware.

**50000091** **\$99.95**

Fits '07-later Softail models (except FXSB and FXSBSE). Stock on '15 FLS, FLSTFB, FLSTN and FLSTNSE models.

## F. CENTER STAND – CHROME

Lifting your bike upright and off the side stand is ideal for cleaning and servicing and reduces the space required for parking – handy where space is at a premium in a crowded garage, a small parking spot or at a ride-in bike show. The robust chrome Center Stand attaches directly to the frame and does not reduce the lean angle. Designed to work with all Original Equipment suspension configurations and with Profile® Suspension lowering kits, the adjustable feet can be set to lift the rear tire clear of the pavement or to keep the rear tire on the ground for reduced lifting effort. The lifting lever is inconspicuously tucked away and fits with all Harley-Davidson® Original Equipment and accessory footboards. Kit includes chrome stand, black mounting brackets and all necessary installation hardware.

**98959-08** **\$334.95**

Fits '08-later Softail models (except FXCW, FXCWC, FXSB, FXSBSE and FXSTSSE3) with Original Equipment or Profile Low Suspension.



**F. CENTER STAND – CHROME**



**\*WARNING:** Do not use engine guard footpegs under normal stop and go operating conditions. Doing so could result in death or serious injury.



**\*WARNING:** Do not use highway pegs under normal stop and go operating conditions. Doing so could result in death or serious injury.

SOFTAIL

Notice: The prices appearing in this catalog are the manufacturer's suggested retail prices. Actual retail prices may vary.

# 284 SOFTAIL®

## Chassis Trim – Front End

### A. CUSTOM INVERTED FRONT FORK KIT

Add a whole new dimension to your motorcycle's front end. Dressed in chrome or gloss black, these big, beefy forks lead your bike in a new custom direction. Featuring leading-edge cartridge damping technology, this 52mm Inverted Front Fork Kit provides a comfortable ride that complements the show-winning looks. From the hidden axle mount to the forged aluminum triple tree, the highly polished fork assembly is loaded with custom details. The forged aluminum axle holder features integrated mounting points that accept Original Equipment fenders and brake calipers without the need for additional brackets. This clean look continues to the billet aluminum outer fork tubes and to the chrome pinch bolts on the triple tree. Top off the custom look with the smooth contour upper triple tree that accepts Original Equipment or accessory handlebars. Manufactured to Harley-Davidson specifications by Marzocchi, this complete fork kit can be used with Original Equipment fork lock. Kit includes chrome-plated installation hardware. Kit requires separate purchase of Axle Kit, Steering Head Bearings, Dust Seals and Braided Brake Lines. FXSTB models require separate purchase of Front Directional Mounting Kit. See your Dealer for details.

Fits '00-'13 FXST, FXSTB and FXSTC models (except models with ABS brakes). Does not fit with Front Caliper Cover P/N 43759-00. All models require separate purchase of model-specific axle kit and additional components.

<b>46321-05B</b>	Chrome.	<b>\$1,599.95</b>
<b>48646-06A</b>	Gloss Black.	<b>\$1,599.95</b>

**Requires separate purchase of:**

Axle Kit, 3/4"	<b>42134-06</b> ('00-'06 models)
Axle Kit, 25mm	<b>42136-07</b> ('07-'13 models)

<b>Braided Brake Line*</b>		<b>Lower</b>	<b>Upper</b>
FXST:	Diamondback™	<b>42366-07</b>	<b>41800058A</b>
	Diamond-Black	<b>48924-10</b>	–
FXSTB:	Diamondback	<b>42366-07</b>	<b>41800025A</b>
	Diamond-Black	<b>48924-10</b>	–
FXSTC:	Diamondback	<b>42366-07</b>	<b>41800031A</b>
	Diamond-Black	<b>48924-10</b>	<b>41800104A</b>
Upper Dust Shield			<b>48361-80</b>
Lower Dust Shield			<b>48365-48A</b>
Roller Bearing (Qty 2)			<b>48300-60</b>

**FXSTB requires additional purchase of:**

Front Directional Mounting Kit	<b>68266-03</b>
Ball Stud (Qty 2)	<b>67822-88</b>

\*For Original Equipment handlebars. See your Dealer for appropriate brake lines if used with other handlebars.

**Also available:**

**INVERTED FRONT FORK AXLE KIT**

Required for installation of Custom Inverted Front Fork Kit P/N 46321-05B or 48646-06A. Kit includes axle and set screw.

**42134-06** 3/4" Axle. **\$49.95**

Fits '00-'06 FXST and FXSTB models equipped with Custom Inverted Fork Kit P/N 46321-05B or 48646-06A.

**42136-07** 25mm Axle. **\$49.95**

Fits '07-'13 FXST, FXSTB and FXSTC models equipped with Custom Inverted Fork Kit P/N 46321-05B or 48646-06A.

Does not fit models with ABS brakes.



**A. CUSTOM INVERTED FRONT FORK KIT – CHROME**



**A. CUSTOM INVERTED FRONT FORK KIT – GLOSS BLACK**

*Notice: The prices appearing in this catalog are the manufacturer's suggested retail prices. Actual retail prices may vary.*



# SOFTAIL® 285

## Chassis Trim – Front End



**B. FRONT END KIT – CHROME (FAT BOY SHOWN)**

### B. FRONT END KITS – CHROME

The front forks on a Harley-Davidson® motorcycle set the tone for the bike and can lead the way to a full-bore custom statement. So start customizing by adding chrome where it will have the most noticeable impact on the overall look of the bike, your front end. A perfect addition during the installation of Premium Ride or Profile® Low Front suspension components, this kit includes components necessary to completely chrome the front forks and includes some or all of the following (Kit components vary depending on your model): Chrome Fork Sliders, Oil Seals, Chrome Fork Axle Retainer Nut Kit, Chrome Fork Slider Drain Screw Kit, Classic Chrome Front Axle Nut Cover Kit and Chrome Upper Fork Nut Covers. Chrome Front End Package price does not include labor or supplies.

**45400005** **\$649.95**  
Fits '08-'11 FLS, FLSTF and FLSTFB models.

**45400006** **\$649.95**  
Fits '12-later FLS, FLSTF, FLSTFB, '07-later FLSTN and '09-later FLSTC models. Also fits '07-'08 FLSTC with separate purchase of front fork cover P/N 67830-09.

### C. LOWER FORK SLIDERS – CHROME

Competitively-priced, these chrome-plated Lower Fork Sliders give your bike upfront style. To ensure proper fitment and function, these sliders are manufactured from Original Equipment components. Form follows function, with polished, chrome-plating and a stamped "Harley-Davidson" logo for product identification. A perfect addition during the installation of Premium Ride or Profile Low Front suspension components, this kit includes right and left sliders and the bottom axle retainer. '07-later model kits also include chrome drain screws, axle retainer bolts and oil seals.

**45500014** **\$449.95**  
Fits '07-later FLS, FLSTC, FLSTN and '08-later FLSTF and FLSTFB models.

**46482-00** **\$449.95**  
Fits '00-'06 FLST, FLSTC, FLSTF and FLSTN models.

**45310-98** **\$449.95**  
Fits '86-'99 FLSTC, FLSTF and FLSTN models.

**46477-00** **\$449.95**  
Fits '00-'05 FXDWG and '00-'06 FXST and FXSTB models.

**45305-98** **\$449.95**  
Fits '91-'99 FXDWG, FXST, FXSTB and FXSTC models.

### D. LOWER FORK SLIDERS – GLOSS BLACK

These gloss black coated sliders are the ultimate extension of your bike's "dark side" and make a perfect custom addition to your blacked-out FL Softail® model. Manufactured to Original Equipment specifications, the durable black coating is a great match to other H-D® black components. Add matching Gloss Black Upper Fork Slider Covers P/N 45591-02 for a complete look. A perfect addition during the installation of Premium Ride or Profile Low Front suspension components, this kit includes right and left sliders, bottom axle retainers, drain screws, axle retainer bolts and oil seals.

**45500015** **\$449.95**  
Fits '07-later FLS, FLSTC, FLSTN, FLSTNSE, '08-later FLSTF, FLSTFB and FLSTSE/2/3 models.



**C. LOWER FORK SLIDERS – CHROME**



**D. LOWER FORK SLIDERS – GLOSS BLACK**

*Notice: The prices appearing in this catalog are the manufacturer's suggested retail prices. Actual retail prices may vary.*

# 286 SOFTAIL®

## Chassis Trim – Front End

### A. UPPER FORK SLIDER COVERS – CHROME

Brilliant chrome accents for the upper fork legs. Perfect for finishing off that chromed front end look. When used with H-D® Genuine Motor Accessory Chrome Lower Fork Sliders, you've got a front end that's completely chromed and an appearance that's utterly impressive.

**45963-97** **\$79.95**  
Fits '49-'84 FL, '80-'13 Touring and Trike models and '86-later FLS, FLST, FLSTC, FLSTF (except '07), FLSTFB and FLSTN. Stock on FLSTNSE and FLSTSE models.



A. UPPER FORK SLIDER COVERS – CHROME

### B. UPPER FORK SLIDER COVERS – GLOSS BLACK

The classic Harley-Davidson® motorcycle color is black. It shows your attitude, your feelings and your desire to be different from the rest. These gloss black accessories are the ultimate extension of the Harley-Davidson philosophy. Manufactured from Original Equipment components, these parts provide superior fit and finish.

**45591-02** **\$79.95**  
Fits '49-'84 FL, '80-'13 Touring and Trike models and '86-later FLS, FLST, FLSTC, FLSTF (except '07) FLSTFB, FLSTN, FLSTNSE and FLSTSE models.



B. UPPER FORK SLIDER COVERS – GLOSS BLACK

### C. LOWER FRONT FORK DUST COVERS – CHROME

Replace your stock black rubber fork slider seals with these beautiful chrome billet aluminum 6061-T6 dust covers.

**45243-00** **\$64.95**  
Fits '84-'89 FXSTC, '84-later FXST, FXSTB, '91-'05 FXDWG and '80-'86 FXWG models.

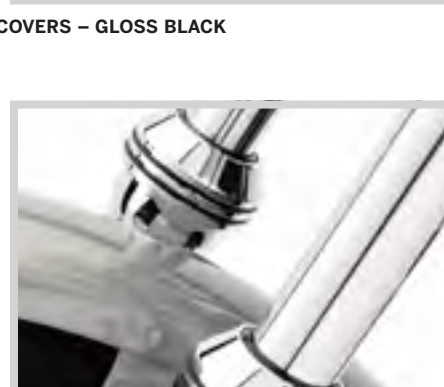

C. LOWER FRONT FORK DUST COVERS – CHROME

### D. DECORATIVE FORK JOINT COVERS – CHROME

Add a bigger, beefy look to the fork slider dust covers without disassembling the front fork. This polished and chrome-plated kit is easy to install without tools.

**45415-82** **\$64.95**  
Fits '84-'89 FXSTC, '84-later FXST, FXSTB, '93-'05 FXDWG and '80-'86 FXWG models.

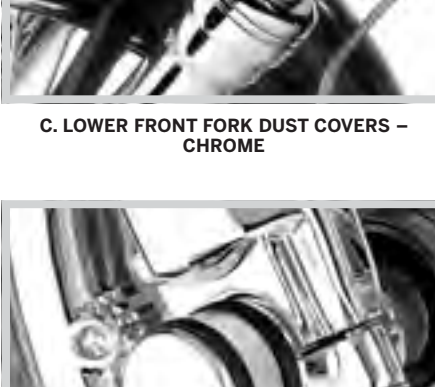

D. DECORATIVE FORK JOINT COVERS – CHROME

### E. FORK AXLE RETAINER NUT KIT – CHROME

It's the details that count. Complete the chrome transformation by adding this finishing touch to your chrome fork sliders. This Axle Retainer Nut Kit includes the stylish chrome-plated nuts and chrome lockwashers necessary to replace the stock hardware.

**45813-03** **\$8.95**  
Fits '84-later Touring and Trike models, '86-'07 FLST, FLSTC, FLSTF, FLSTN '91-'07 FXST and FXSTB, '07 FXSTC and '91-'05 FXDWG models.



E. FORK AXLE RETAINER NUT KIT – CHROME

### F. FORK SLIDER DRAIN SCREW KIT – CHROME

It's the details that count. Complete the chrome transformation by adding this finishing touch to your chrome fork sliders. This Fork Slider Drain Screw Kit includes two chrome-plated drain screws and the seals required to replace the stock hardware.

**45848-03** **\$3.95**  
Fits '87-later Softail® (except Springer™, FXCW, FXCWC, FXSB, FXSBSE and FXSTD), '87-'13 Touring and Trike models and '93-'05 FXDWG models.

**45815-03** **\$3.95**  
Fits '73-'13 XL models (except XL Sport, XL883L, XL1200X and '11-later XL1200C), '78-'86 FX models, '94-'05 Dyna® FXD/DL/DS-CONV., '99-'00 FXR2/3/4 models and '00-'07 FXSTD models.



F. FORK SLIDER DRAIN SCREW KIT – CHROME

*Notice: The prices appearing in this catalog are the manufacturer's suggested retail prices. Actual retail prices may vary.*



**G. FRONT WHEEL SPACER KIT – CHROME****H. ABS FRONT WHEEL SPACER KIT – CHROME****I. ABS HARNESS COVER – CHROME****J. FRONT FENDER HARDWARE KIT – CHROME****K. CUSTOM FORK BRACE****L. FORK COVER MEDALLIONS – THE BURST COLLECTION****G. FRONT WHEEL SPACER KIT – CHROME**

There's always more room for chrome with these highly-polished chrome Wheel Spacer Kits. They're manufactured to the Original Equipment tolerances, so you get exact product fitment and quality.

**41597-07** **\$29.95**

Fits '07-'13 FXS, FXST, FXSTB, FXSTC and FXSTD models (except models with ABS brakes). Also fits Softail® models equipped with Inverted Front Fork Kit and 25mm Axle Kit P/N 42136-07.

**41583-07** **\$29.95**

Fits '12-later FLS models without ABS brakes. Also fits '07-'13 FLSTF, FLSTFB, FLSTC and FLSTN models (except models with ABS brakes). FLSTC and FLSTN models require removal of Original Equipment hub cap.

**41597-00** **\$29.95**

Fits '00-'06 FXST, FXSTB, FXSTD and '00-'05 FXDWG models. Also fits models equipped with Inverted Front Fork Kit and 3/4" Axle Kit P/N 42134-06 or Billet Fork Sliders P/N 46280-03. (Does not fit '03-'04 FXSTDSE.)

**41583-03** **\$29.95**

Fits '00-'06 FLST, FLSTF, FLSTC and FLSTN models. FLSTC and FLSTN models require removal of Original Equipment hub cap.

**H. ABS FRONT WHEEL SPACER KIT – CHROME**

Complete your total front end with these highly polished chrome-plated wheel spacers. Manufactured to the Original Equipment tolerances, they deliver exact fitment and custom shine.

**43300010** Domed. **\$49.95**

Fits '11-later FLS, FLSTF, FLSTFB, FLSTC and FLSTN models with ABS brakes. FLSTC and FLSTN models require removal of Original Equipment hub cap. Stock on FLSTNSE.

**I. ABS HARNESS COVER – CHROME**

Dress your ABS-equipped Softail model in style. Shaped to conceal the ABS wheel speed sensor harness, this bracket mounts to the brake caliper tabs on the lower fork sliders. The mirror-chrome finish complements the Original Equipment satin polished sliders or serves as the final finishing touch to a complete chrome front end.

**32700002** **\$37.95**

Fits '11-later Softail models (except FXCWC, FXSB and FXSBSE) equipped with ABS.

**J. FRONT FENDER HARDWARE KIT – CHROME**

Finish the show-winning look with brilliant chrome hardware. Manufactured to Original Equipment specifications, this kit replaces the zinc-plated exposed front fender mounting bolts with chrome-plated socket head cap screws.

**94415-05** **\$9.95**

Fits '91-later Softail models (except Springer™, FXCW, FXCWC, FXSB, FXSBSE and FXSTD) and '93-'05 FXDWG models. Does not fit with Billet Fork Slider Kit or Inverted Front End Kit.

**K. CUSTOM FORK BRACE**

This chrome-plated Fork Brace adds style to the front end. The cross-brace open web style reflects a performance heritage and the multi-piece design allows easy installation.

**46097-98** 41mm. **\$159.95**

Fits '93-'05 FXDWG and '84-later FX Softail models (except Springer, FXCW, FXCWC, FXS, FXSB, FXSBSE and FXSTD). (Will not fit with Chrome Lower Fork Sliders.)

**L. FORK COVER MEDALLIONS – THE BURST COLLECTION**

These 5" medallions feature a curved mounting surface that fit perfectly to Upper Fork Slider Covers. Includes a slider cover mounting template. Easy to install. Sold in pairs.

**14100434** **\$59.95**

Fits '49-'84 FL, '80-later Touring models and '86-later FLST, FLSTC, FLSTF (except '07), FLSTFB, FLSTSE/2 and FLSTN models.

# 288 SOFTAIL®

Chassis Trim – Front End

## FRONT AXLE NUT COVERS

Cover the front axle in style. Available in your choice of styles, these custom Axle Nut Covers look great with Original Equipment satin-finish fork sliders or as the finishing touch to a complete chrome or blacked-out front end. These easy to install kits include all necessary mounting hardware.

### A. FRONT AXLE NUT COVERS

Fits '02-'11 VRSC™ (except VRSCF, VRSCR and '12-later VRSCDX), '15-later XG, '08-later XL, '08-later Dyna®, '07-later Softail® (except Springer™, FXCW, FXCWC, FLSTNSE, FXSBSE, FXST-Aus and FXSTD) and '08-later Touring and Trike models.

<b>44117-07A</b>	Chrome – Die-cast.	<b>\$27.95</b>
<b>44116-07A</b>	Chrome – Billet.	<b>\$42.95</b>
<b>43000026</b>	Gloss Black – Die-Cast.	<b>\$27.95</b>
<b>43428-09</b>	Gloss Black – Billet.	<b>\$42.95</b>

Fits '88-'07 XL, '91-'03 Dyna FXD, FXDX, FXDXT, FXDL, FXDS-CONV., '93-'05 FXDWG, '84-'06 Softail (except Springer and FXSTD), '80-'99 Touring models. Also fits '88-'07 FXR and '87-later FLXR/FXRS-SP, FXWG models.

<b>43899-86A</b>	Chrome – Die-cast.	<b>\$27.95</b>
------------------	--------------------	----------------

Fits '88-'06 FXSTS Springer models. (Does not fit FLSTS.)

<b>43894-90</b>	Chrome – Die-cast.	<b>\$29.95</b>
-----------------	--------------------	----------------

Fits '08-'11 FLSTSB models.

<b>41088-09</b>	Gloss Black.	<b>\$69.95</b>
-----------------	--------------	----------------

### B. "H-D MOTOR CO." LOGO FRONT AXLE NUT COVERS

**44148-07A** **\$29.95**  
Fits '02-'11 VRSC (except VRSCF, VRSCR and '12-later VRSCDX), '15-later XG, '08-later XL, '08-later Dyna, '07-later Softail (except Springer, FXCW, FXCWC, FXSB, FXSBSE, FXST-Aus, FXSTD and FLSTNSE) and '08-later Touring and Trike models.

<b>43864-96</b>	<b>\$29.95</b>
Fits '88-'07 XL, '91-'03 Dyna FXD, FXDX, FXDXT, FXDL, FXDS-CONV., '93-'05 FXDWG, '84-'06 Softail (except Springer and FXSTD), '80-'99 Touring models. Also fits '88-'07 FXR and '87-later FLXR/FXRS-SP, FXWG models.	

### C. BURST FRONT AXLE NUT COVERS

<b>43000031</b>	<b>\$69.95</b>
Fits '02-'11 VRSC (except VRSCF, VRSCR and '12-later VRSCDX), '15-later XG, '08-later XL, '08-later Dyna, '07-later Softail (except Springer, FXCW, FXCWC, FXSB, FXSBSE, FXSTD and FLSTNSE) and '08-later Touring and Trike models.	

### D. WILLIE G SKULL FRONT AXLE NUT COVERS

<b>43163-08A</b>	<b>\$34.95</b>
Fits '02-'11 VRSC (except VRSCF, VRSCR and '12-later VRSCDX), '15-later XG, '88-later XL, '91-later Dyna, '84-later Softail (except Springer, FXCW, FXCWC, FXSB, FXSBSE, FXSTD and FLSTNSE) and '99-later Touring and Trike models.	

### E. ALUMINATOR® FRONT AXLE NUT COVERS

<b>44114-07</b>	<b>\$42.95</b>
Fits '02-'11 VRSC (except VRSCF, VRSCR and '12-later VRSCDX), '08-later Dyna, '07-later Softail (except Springer, FXCW, FXCWC, FXSB, FXSBSE, FXST-Aus, FXSTD and FLSTNSE) and '08-later Touring models.	

<b>43907-94</b>	<b>\$42.95</b>
Fits '88-'07 XL, '91-'03 Dyna FXD, FXDX, FXDXT, FXDL, FXDS-CONV., '93-'05 FXDWG, '84-'06 Softail (except Springer and FXSTD), '80-'99 Touring models. Also fits '88-'07 FXR and '87-later FLXR/FXRS-SP, FXWG models.	

### F. TAPERED FRONT AXLE NUT COVERS

<b>44109-07</b>	<b>\$27.95</b>
Fits '02-'11 VRSC (except VRSCF, VRSCR and '12-later VRSCDX), '08-later Dyna, '07-later Softail (except Springer, FXCW, FXCWC, FXSB, FXSBSE, FXST-Aus, FXSTD and FLSTNSE) and '08-later Touring models.	

### G. TEARDROP FRONT FORK ROCKER COVER KIT

Nostalgic chrome-plated styling that seems to be in constant motion. Easily installs on Heritage Springer® models without removing wheel.

<b>43161-97</b>	<b>\$69.95</b>
Fits '97-'03 FLSTS and '05-'07 FLSTSC models.	



A. FRONT AXLE NUT COVERS – CHROME



A. FRONT AXLE NUT COVERS – GLOSS BLACK



B. "H-D MOTOR CO." LOGO FRONT AXLE NUT COVERS



C. BURST FRONT AXLE NUT COVERS



D. WILLIE G SKULL FRONT AXLE NUT COVERS



E. ALUMINATOR FRONT AXLE NUT COVERS



F. TAPERED FRONT AXLE NUT COVERS



G. TEARDROP FRONT FORK ROCKER COVER KIT

*Notice: The prices appearing in this catalog are the manufacturer's suggested retail prices. Actual retail prices may vary.*



# SOFTAIL® 289

Chassis Trim – Front End



**H. LOWER TRIPLE TREE COVER – CHROME (FL SOFTAIL SHOWN)**

## H. LOWER TRIPLE TREE COVER – CHROME

This Lower Triple Tree Cover dresses up the unfinished underside of the triple tree for a complete custom look. The chrome-plated steel cover installs easily, concealing the brake splitter fitting. All mounting hardware is included.

**66053-01** **\$44.95**

Fits '00-later FL Softail® models (except Springer™ and FLSTN).

**66021-00** Fits '00-'07 FXSTD models. **\$39.95**

## I. UPPER FORK NUT COVERS – CHROME

Highlighted with a unique Bar & Shield logo, these polished triple chrome-plated covers add an additional clean looking appearance to your upper fork. Kit comes complete with three covers, mounting hardware and wrench for easy, on-the-spot installation.

**46129-98B** **\$59.95**

Fits '86-later FLSTC, '90-later FLS, FLSTF, '95-'05 FXD, '93-'05 FXDL, '94-'05 FXDS-CONV. and '88-'13 XL models (except XL Custom and XL1200S models.)

**45002-98** **\$59.95**

Fits '00-later FXST, FXSTB, FXSTD and '86-later FXSTC models and '93-'05 FXDWG models.

## J. TIE-DOWN BRACKETS – CHROME

Simplify the process of securing your bike to a trailer or bike lift. These stylish chrome Tie-Down Brackets mount cleanly to the front fork cover and offer a secure method to connect tie-down straps. Moving the tie-down point from the handlebar to the triple tree area reduces wear on the handlebar bushings and ensures a consistent easy-to-access mounting point. Just add Harley-Davidson® Ratchet Straps and Soft Hooks and you're ready to go.

**93500006** **\$59.95**

Fits '00-later FLS, FLSTC and FLSTF/B, '95-later FLHR, FLHRC, '95-'13 FLHT, FLHTC, FLHX, FLHXSE/2/3 and '10-'13 FLHTCU, FLHTK and FLHTCUSE4/5/6/7. FLS, FLSTF and FLSTFB models without a windshield require separate purchase of Hardware Kit P/N 91800030.

**Shown with:**

### TIE-DOWN BRACKET HARDWARE KIT

Kit includes 4 button-head bolts required for installation of Chrome Tie-Down Brackets P/N 93500006 on specified models.

**91800030** **\$9.95**

Required for installation of Chrome Tie-Down Bracket Kit P/N 93500006 on '00-later FLS, FLSTF and FLSTFB models without windshields.



**H. LOWER TRIPLE TREE COVER – CHROME (FL SOFTAIL SHOWN)**



**H. LOWER TRIPLE TREE COVER – CHROME (SOFTAIL DEUCE SHOWN)**



**I. UPPER FORK NUT COVERS – CHROME**



**J. TIE-DOWN BRACKETS – CHROME**

*Notice: The prices appearing in this catalog are the manufacturer's suggested retail prices. Actual retail prices may vary.*

# 290 SOFTAIL®

## Chassis Trim – Front End

### A. FREIGHT TRAIN HEADLIGHT NACELLE

If the shape of this nacelle seems to reflect the image of the 1960s FL models, that's because the spirit of the past is built right in. Bold locomotive styling adds visual strength to the bike's profile and stretches the rider's view to the horizon when looking over the headlamp. Coupled with the separate purchase of the Nacelle Hardware Kit P/N 67897-96B, the nacelle fits with an existing H-D® windshield and/or passing lamps. Kit includes hardware required for installation of the nacelle with a detachable windshield without passing lamps. Separate Hardware Kit is required when installing nacelle with passing lamps or rigid mount windshield.

Fits '86-later FLST, FLSTF, FLSTFB and FLSTC models. '07-later FLSTF and FLSTFB require separate purchase of Riser Kit P/N 56789-05. '09-later FLSTC requires separate purchase of Riser Kit P/N 46809-09.

<b>67907-96C</b>	Chrome.	<b>\$449.95</b>
<b>61300138</b>	Gloss Black.	<b>\$449.95</b>

#### Also available:

#### RISER KIT FOR FREIGHT TRAIN HEADLIGHT NACELLE

Required for installation of Freight Train Headlamp Nacelle.

<b>46809-09</b>	<b>\$84.95</b>
-----------------	----------------

Fits '09-later FLSTC models equipped with Freight Train Headlight Nacelle Kit P/N 67907-96C or 61300138.

<b>56789-05</b>	<b>\$134.95</b>
-----------------	-----------------

Fits '07-later FLSTF and FLSTFB models equipped with Freight Train Headlight Nacelle Kit P/N 67907-96C or 61300138.

### B. SMOOTH FORK COVER KIT – CHROME

Bring the smooth look of the Softail® Deluxe model to your Heritage Softail® Classic model. Mirror-finish chrome flows over the surface and wraps around the triple tree for a custom fit. This three-piece kit includes smooth front panel and matching left and right side panels.

<b>66440-05</b>	<b>\$119.95</b>
-----------------	-----------------

Fits '00-'08 FLSTC models. Can be used with Auxiliary Lighting Kit P/N 68669-05A, 68670-05A and 69287-07.



A. FREIGHT TRAIN HEADLIGHT NACELLE – CHROME



A. FREIGHT TRAIN HEADLIGHT NACELLE – GLOSS BLACK



B. SMOOTH FORK COVER KIT – CHROME  
(SHOWN WITH DELUXE AUXILIARY LIGHTING KIT)

Notice: The prices appearing in this catalog are the manufacturer's suggested retail prices. Actual retail prices may vary.



# SOFTAIL® 291

Chassis Trim – Front End



C. FORK COVER KIT – CHROME



## C. FORK COVER KIT – CHROME

Replace your factory-original satin fork covers with these brilliant, triple chrome-plated versions for a custom mirror-like shine.

**67890-91C** **\$139.95**

Fits '93-later FLSTN and '86-'08 FLST, FLSTF, FLSTFB models. Does not fit FLSTC with Original Equipment light bar or models with Auxiliary Lighting Kit P/N 69287-07 or 68000026.

## D. FORK COVER KIT – GLOSS BLACK

Replace the factory-original satin finished fork covers with these rich gloss black editions for a sinister blacked-out look. Originally featured on the '10 FLSTFB Fat Boy® Lo, this three-piece kit includes the ribbed front panel and the matching left and right side panels that wrap around the triple tree for a solid, no-nonsense appearance. Finish the look with Gloss Black Side Accent Strips P/N 68055-10BHP (2) and Black Headlamp Shell P/N 73294-10.

**48608-09** **\$139.95**

Fits '86-later FLS, FLST, FLSTF and '93-'96 FLSTN models. Does not fit FLSTC with Original Equipment light bar or '05-later FLSTN unless Original Equipment light bar is removed and front turn signals are installed. Stock on '10-later FLSTFB models.

**Shown with:**

## FORK COVER ACCENT STRIPS – GLOSS BLACK

These strips are designed to add the ultimate complement to the Gloss Black Fork Cover Kit. Finished in matching rich black, these extruded aluminum pieces fill the gap between the front and rear covers that is created when the passing lamps are removed. Strips are sold individually and two are required for a complete installation.

**68055-10BHP** **\$19.95**

Fits '86-later FLS, FLST, FLSTC, FLSTF, '93-'96 FLSTN models with Gloss Black Fork Cover Kit P/N 48608-09. (Does not fit with passing lamps or windshields.)

**Also shown with:**

## HEADLAMP SHELL – GLOSS BLACK

Add to the sinister look of your blacked-out Softail® motorcycle. Manufactured from Original Equipment components, this gloss black headlamp housing replaces the chrome headlamp shell for a custom look. Shell includes wiring harness and connector and accepts the Original Equipment headlamp, trim ring and mounting hardware.

**73294-10** Domestic. **\$197.00**

Fits '86-later FLS, FLST, FLSTC, FLSTF and FLSTN models in domestic and right-hand drive markets.



D. FORK COVER KIT – GLOSS BLACK  
(SHOWN WITH ACCENT STRIPS  
AND HEADLAMP SHELL)



D. FORK COVER KIT – GLOSS BLACK  
(SHOWN WITH ACCENT STRIPS)

## E. FORK COVER SIDE PANELS – CHROME

Complete the chrome finish of the Softail Deluxe model Fork Cover. These side panels replace the polished panels that wrap around the rear of the triple tree. Easy to install, this kit includes left and right side panels.

**66441-05** **\$59.95**

Fits '05-later FLSTN, '07-later FLSTF, FLSTFB and '09-later FLS, FLSTC models. Stock on FLSTNSE.



E. FORK COVER SIDE PANELS – CHROME



F. FORK COVER ACCENT STRIP KIT – CHROME

## F. FORK COVER ACCENT STRIP KIT – CHROME

Sometimes the best ideas come from you, our fellow riders, like this chrome accent strip. This kit is designed to add the ultimate complement to the already popular Chrome Fork Cover Kit by accenting the sides with beautiful chrome-plated aluminum strips. Kit includes chrome hardware.

**67891-99** **\$29.95**

Fits '86-'11 FLSTF, FLSTFB and '93-'96 FLSTN models with Chrome Fork Cover Kit P/N 67890-91C or 66440-05. Stock on '12-later FLS, FLSTF and FLSTFB. Does not fit with passing lamps and windshields.

*Notice: The prices appearing in this catalog are the manufacturer's suggested retail prices. Actual retail prices may vary.*

# 292 SOFTAIL®

## Chassis Trim – Front End

### A. FRONT FENDER TRIM KIT – CHROME

Replace the Original Equipment stainless steel fender trim with a splash of chrome. Kit includes left and right side trim strip.

**59209-91T** **\$29.95**

Fits '82-'13 Touring models (except Road Glide® and Road King® Custom), '86-later FLSTN and FLSTC models. Does not fit models equipped with clean front fender.



A. FRONT FENDER TRIM KIT – CHROME

### B. HERITAGE FRONT FENDER RAIL – CHROME\*

A stylish re-creation of a popular Hydra Glide model accessory direct from the Harley-Davidson® 1959 accessories catalog. Ornate, jet, twin-tube design sweeps smartly back along the front fender. Sparkling chrome-plating and years-ahead styling make it a hit for all Heritage and FLSTN owners.

**91080-93** **\$99.95**

Fits '87-later FLST, FLSTC and '93-'96 FLSTN models. (Does not fit Springer™ models.)

### C. HERITAGE REAR FENDER RAIL – CHROME\*

A perfect match to Heritage Chrome Front Fender Rail P/N 91080-93. Designed to fit with stock FLSTC, FLSTN saddlebags or Genuine Harley-Davidson Fat Boy® leather saddlebags.

**91402-00** **\$99.95**

Fits '00-later FLST and FLSTC models.



B. HERITAGE FRONT FENDER RAIL – CHROME



C. HERITAGE REAR FENDER RAIL – CHROME

### D. FRONT FENDER RAIL AND STANCHION KIT\*

Chrome-plated accents straight from our 1947 catalog. Includes template for easy installation.

**91117-97** **\$69.95**

Fits '84-later FL Softail® (except FLS, FLSTF, FLSTNSE, FLSTFB, FLSTSE/2/3 and FLSTSB), Touring and Trike models.

### E. FRONT FENDER TRIM

Add a sweeping dash of chrome to the front fender. Chrome-plated tapered spear features a stepped design that accentuates the flowing fender lines. Self-adhesive backing simplifies installation.

**14100618** **\$44.95**

Fits Dyna® FLD, FL Softail, Touring and Trike models with full front fender.



D. FRONT FENDER RAIL AND STANCHION KIT



E. FRONT FENDER TRIM

### F. BAR & SHIELD LOGO FRONT FENDER SPEAR

This chrome-plated trim spear adds a sweeping dash of chrome to the front fender. Featuring a raised Bar & Shield logo set against a textured black field, this self-adhesive medallion is easy to install.

**91195-04** Large. **\$44.95**

Fits Touring, Dyna FLD and FL Softail models (except FLSTSB).

**91194-04** Small. **\$39.95**

Fits XL, XR, Dyna (except FLD) and FX Softail models.



F. BAR & SHIELD LOGO FRONT FENDER SPEAR (LARGE SHOWN)



F. BAR & SHIELD LOGO FRONT FENDER SPEAR (SMALL SHOWN)



**\*WARNING:** Fender rails are decorative items only. Do not strap anything to the rails. Adding any additional weight to the front fender could adversely affect vehicle handling, causing loss of control and death or serious injury.

Notice: The prices appearing in this catalog are the manufacturer's suggested retail prices. Actual retail prices may vary.



# SOFTAIL® 293

## Chassis Trim – Front End



**G. FENDER TIP LENS KIT WITH SKULL LOGO**

**H. BAR & SHIELD LOGO FENDER TIP LENS KIT**

### G. FENDER TIP LENS KIT WITH SKULL LOGO

This chrome-plated fender tip lens kit adds a little attitude to your ride. The kit features front and rear lenses with a translucent illuminated skull silhouette. The easy-to-install kit includes an amber front lens and red rear lens.

**59651-01** Front and Rear. **\$29.95**  
Fits '80-'08 Electra Glide®, Tour Glide™, FLHS, Road King® (except Road King Classic and FLHRS), '86-'08 FLSTC and '93-'96 FLSTN models.

### H. BAR & SHIELD LOGO FENDER TIP LENS KIT

Chrome-plated polycarbonate construction features translucent Bar & Shield emblems. The kit includes front and rear lenses. Front lens features an amber Bar & Shield logo, rear lens features a red Bar & Shield logo. Quick and easy installation.

**59081-96** Front and Rear. **\$29.95**  
Fits '80-'08 FLHT, FLT, FLHS, FLHR models and '86-'08 FLSTC, '93-'96 FLSTN models. (Does not fit FLHRS, Springer™ or FLTR.)

### I. "H-D" CLASSIC FENDER TIP

Stock on Road King Classic models, these nostalgic-look fender tips are also available for other models. Replaces fender lamp assembly.

**59002-98** Front. **\$31.95**  
Fits '80-'13 FL, FLHR and FLHTCUTG models and '86-'08 FLSTC models.

**59052-98** Rear. **\$31.95**  
Fits '80-'08 FL and FLHR models and '86-'99 FLSTC models. (Does not fit FLSTF and FLTR models.)

### J. HARLEY-DAVIDSON "LIVE TO RIDE" LOGO FENDER TIPS

Made of durable ABS plastic. Includes mounting hardware and installation instructions.

**59068-96** Front. **\$35.95**  
Fits '80-'13 FLT, FLHTCUTG, FLHR, FLSTC and '93-'96 FLSTN models (replaces fender lamp assembly). (Does not fit Springer, FLHRS and FLTR models.)

**59069-96** Rear. **\$35.95**  
Fits '80-'08 FLT, FLHR, FLSTC and '93-'96 FLSTN models (replaces fender lamp assembly). (Does not fit Springer, FLHRS and FLTR models.)

### K. EAGLE WING FENDER TRIM FOR FAT BOY® MODELS

Classic Eagle Wing logo available in chrome or two-tone chrome and gold with black accent. Matches Eagle Wing headlamp, tail lamp and turn signal visors.

Fits '90-'06 FLSTF models.

**1. 59369-97** Rear, Gold Two-Tone. **\$35.95**  
**59368-97** Rear, Chrome. **\$29.95**

Fits '90-later FLSTF and FLSTFB models.

**2. 59367-97** Front, Gold Two-Tone. **\$35.95**  
**59366-97** Front, Chrome. **\$29.95**

### L. EAGLE FENDER TRIM FOR FAT BOY MODELS

This solid brass fender trim is hand-polished and features finely detailed Eagle and "Harley-Davidson" graphics. Includes mounting hardware and foam pad attached to underside of trim to resist scratches when installing.

Fits '90-'06 FLSTF models.

**1. 59286-90** Rear, Chrome. **\$29.95**

Fits '90-later FLSTF and FLSTFB models.

**2. 59285-90** Front, Chrome. **\$29.95**



**I. "H-D" CLASSIC FENDER TIP**

**J. HARLEY-DAVIDSON "LIVE TO RIDE" LOGO FENDER TIP**



**K. EAGLE WING FENDER TRIM FOR FAT BOY MODELS**

**L. EAGLE FENDER TRIM FOR FAT BOY MODELS**

Notice: The prices appearing in this catalog are the manufacturer's suggested retail prices. Actual retail prices may vary.

# 294 SOFTAIL®

## Chassis Trim – Front End

### A. WILLIE G SKULL FENDER SKIRT

This decorative chrome-plated fender skirt is a direct replacement for stock fender skirt. Features a three-dimensional sculptured concho with skull design set off with black accents. Mounting hardware included.

**59582-02A** **\$59.95**

Fits '80-'13 Touring, '09-'13 Trike, '86-'08 FLSTC, '06 FLST and '93-'96 FLSTN models equipped with Original Equipment fender skirt.

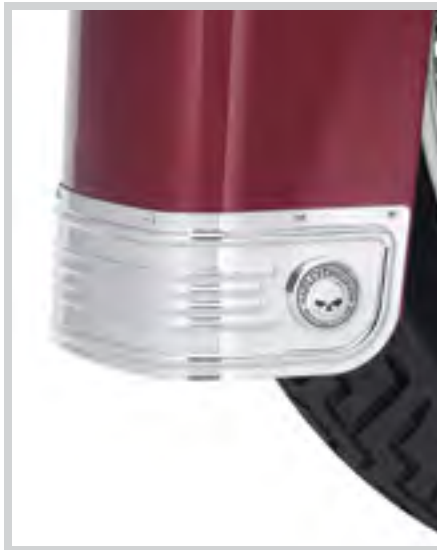

A. WILLIE G SKULL FENDER SKIRT

### B. CONCHO FENDER SKIRT

This decorative fender skirt features conchos inspired by the Heritage Softail® Classic.

**59147-96** **\$59.95**

Fits '80-'13 Touring, '09-'13 Trike, '86-'08 FLSTC, '06 FLST and '93-'96 FLSTN models equipped with Original Equipment fender skirt.

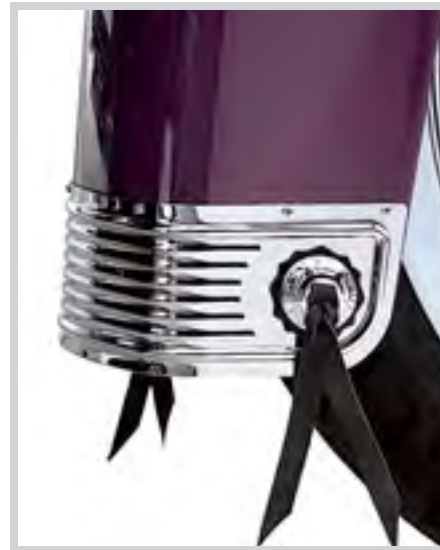

B. CONCHO FENDER SKIRT

### C. V-LOGO FENDER SKIRT

V-Logos are die-cast aluminum integrated with the fender skirt, then chrome-plated for a desirable shine. Includes all mounting hardware.

**59146-96** **\$59.95**

Fits '80-'13 Touring, '09-'13 Trike, and '86-'08 FLSTC, '06 FLST and '93-'96 FLSTN models equipped with Original Equipment fender skirt.



C. V-LOGO FENDER SKIRT

### D. FLAMES FENDER SKIRT

Designed as an easy-to-install replacement for the Original Equipment fender skirt, this chrome steel fender skirt features an embossed 3-D flame design. Kit includes mounting hardware.

**60179-06** **\$59.95**

Fits '80-'13 Touring, '09-'13 Trike, and '86-'08 FLSTC, '06 FLST and '93-'96 FLSTN models equipped with Original Equipment fender skirt.



D. FLAMES FENDER SKIRT

### E. BAR & SHIELD FENDER SKIRT

This rigid-steel fender skirt, designed to replace the original factory-equipped aluminum trim, is formed, polished and chrome-plated. Its ribbed pattern offers a unique styling element and adds rigidity. Subtle but distinctive brushed aluminum Bar & Shield logos are framed by a stamped-in ribbed outline on both sides.

**59228-91** **\$59.95**

Fits '80-'13 Touring, '09-'13 Trike, and '86-'08 FLSTC, '06 FLST and '93-'96 FLSTN models equipped with Original Equipment fender skirt.



E. BAR & SHIELD FENDER SKIRT

### F. FRONT FENDER EXTENSION – CHROME

Dress your front fender in chrome. This chrome-plated tapered Fender Extension is shaped to follow the curve of the fender for style and function. Using the Original Equipment fender hole, the extension mounts below the trailing edge of the fender to help control road dirt and spray.

**59664-03** **\$49.95**

Fits '91-'08 Dyna® and '84-'07 FX Softail® models. (Will not fit FXD, FXDX or FXDXT models equipped with Voltage Regulator Covers.)

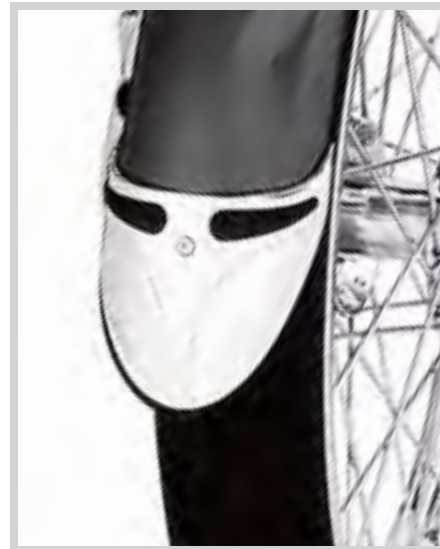

F. FRONT FENDER EXTENSION – CHROME

*Notice: The prices appearing in this catalog are the manufacturer's suggested retail prices. Actual retail prices may vary.*





**G. UPPER BELT GUARD – CHROME**



**H. SHOR'TEE UPPER BELT GUARD – CHROME**



**H. SHOR'TEE UPPER BELT GUARD – GLOSS BLACK**

## SOFTAIL® 295

Chassis Trim – Rear End

### G. UPPER BELT GUARD – CHROME

Hand-polished and chrome-plated to replace your factory-equipped painted upper belt guard.

**60867-08** **\$109.95**

Fits '07-later FXS, FXSB, FXST, FXSTB, FXCW, FLS, FLSTFB, FLSTSB and FLSTSC models. Stock on many '07-later Softail® models.

### H. SHOR'TEE UPPER BELT GUARD

Give your Softail motorcycle a unique stylish look. Designed as a direct replacement for the Original Equipment upper belt guard, this slotted steel guard adds a minimalistic "bobbed" look to the bike's profile. With its cut-down length and turned-up tail, this Upper Belt Guard is the ultimate extension of your bike's personality. Available in your choice of mirror chrome or sinister gloss black finish, this kit includes all required mounting hardware.

Fits '08-later Softail models.

**60490-08** Chrome. **\$114.95**

**60300004** Gloss Black. **\$109.95**

Fits '00-'06 Softail models.

**60610-02A** Chrome. **\$109.95**

# 296 SOFTAIL®

Chassis Trim – Rear End

## A. SWINGARM – CHROME

The ultimate chrome accessory, mirror-polished to the highest standard using bright chrome-plating. Affordable and convenient with no troublesome exchanges necessary. Factory specifications guarantee exact fitment, unparalleled quality and an affordable price. Stamped with the Harley-Davidson Bar & Shield logo.

**48607-08A** **\$559.95**  
Fits '08-later Softail® models (except FXCW, FXCWC, FXSB and FXSBSE).

**48607-06** **\$589.95**  
Fits '06-'07 FXST, FXSTB, FXSTS and '07 FXSTC, FXSTSSE and FLSTF models.



A. SWINGARM – CHROME



A. SWINGARM – CHROME

## B. REAR FENDER EXTENSION – POLISHED STAINLESS

Designed to replace the black plastic rear fender splash guard, this stainless steel shield is formed to match the contour of the swingarm arc. Polished to a mirror-finish, this fender extension adds depth and dimension by reflecting light into a usually dark and hidden area. A great finishing touch to a chrome swingarm and custom wheel installation. Kit includes fitted stainless steel splash guard, attachment clips and chrome hardware.

**60197-08** **\$74.95**  
Fits '08-'10 Softail models (except FXCW, FXCWC and FXSTSSE3).

**60476-00A** **\$49.95**  
Fits '00-'07 Softail models.

## C. LOWER BELT GUARD

This handsome formed steel guard replaces the Original Equipment plastic debris deflector, providing a rich smooth surface that complements the swingarm and frame. Available in chrome or gloss black finish, this complete kit includes all required mounting hardware.

Fits '07-later FLS, FLSTC, FLSTN, FLSTNSE, FXS, FXSB, FXSBSE and FXSTD models.

**60654-07A** Chrome. **\$94.95**  
**57100179** Gloss Black. **\$94.95**

Fits '07-later FXST, FXSTB, FXSTC, FLSTF, FLSTFB, FLSTSB, FLSTSE2/3, FXSTSSE/2 and '14-'15 FLSTNSE. Chrome version stock on FXSTSSE/2, FLSTSE/2/3 and FLSTNSE models.

**60655-07A** Chrome. **\$94.95**  
**57100180** Gloss Black. **\$94.95**

Fits '08-later FXCW and FXCWC models.

**60345-08A** Chrome. **\$129.95**

Fits '00-'06 Softail models (except '06 FXST, FXSTB and FXSTS).

**60316-00A** Chrome with H-D Script Logo. **\$94.95**



B. REAR FENDER EXTENSION – POLISHED STAINLESS (60476-00A SHOWN)



B. REAR FENDER EXTENSION – POLISHED STAINLESS (60197-08 SHOWN)



C. LOWER BELT GUARD – CHROME (60654-07A SHOWN)



C. LOWER BELT GUARD – GLOSS BLACK

*Notice: The prices appearing in this catalog are the manufacturer's suggested retail prices. Actual retail prices may vary.*



# SOFTAIL® 297

Chassis Trim – Rear End



**D. SWINGARM PIVOT BOLT COVERS – CHROME**



**D. SWINGARM PIVOT BOLT COVERS – GLOSS BLACK**



**E. SWINGARM PIVOT BOLT COVERS – WILLIE G SKULL COLLECTION**



**F. SWINGARM PIVOT BOLT COVERS – “HARLEY-DAVIDSON MOTOR CO.” LOGO**



**G. UPPER SWINGARM COVER KIT – CHROME**

## D. SWINGARM PIVOT BOLT COVERS

Cover your swingarm pivot bolt with distinctive styling. Available in your choice of mirror chrome or gloss black finish, this kit includes set screws and Allen® wrench for easy installation (sold in pairs).

Fits '08-later Softail® models (except FXCW, FXCWC, FXSB, FXSBSE and FXST-Aus).

<b>47612-08</b>	Chrome – Billet.	<b>\$43.95</b>
<b>47660-09</b>	Chrome – Die-cast.	<b>\$31.95</b>
<b>47649-09</b>	Gloss Black – Billet.	<b>\$43.95</b>

Fits '00-'07 Softail models (except FLSTF, FXSTD and models with Passenger Footboard Kit).

<b>43462-00</b>	Chrome – Die-cast.	<b>\$34.95</b>
-----------------	--------------------	----------------

Fits '84-'99 Softail models (except FLSTS).

<b>43897-86B</b>	Chrome – Die-cast.	<b>\$34.95</b>
------------------	--------------------	----------------

## E. SWINGARM PIVOT BOLT COVERS – WILLIE G SKULL COLLECTION

Add a little attitude to your ride. Styled to complement Harley-Davidson® Skull accessory items, the menacing raised skull with black-filled eyes leaps from a field of chrome. The surrounding “Harley-Davidson Motorcycles” script is the perfect finishing touch. This easy-to-install kit includes left and right pivot bolt covers and necessary mounting hardware.

<b>47663-09</b>		<b>\$29.95</b>
-----------------	--	----------------

Fits '08-later Softail models (except FXCW, FXCWC, FXSB, FXSBSE and FXST-Aus).

<b>43235-08</b>		<b>\$34.95</b>
-----------------	--	----------------

Fits '00-'07 Softail models (except FLSTF, FXSTD and models with Passenger Footboard Kit).

## F. SWINGARM PIVOT BOLT COVERS – “HARLEY-DAVIDSON MOTOR CO.” LOGO

Die-cast, chrome-plated with black “Harley-Davidson Motor Co.” logo. Includes set screws and Allen wrench for easy installation (sold in pairs).

<b>47630-09</b>		<b>\$31.95</b>
-----------------	--	----------------

Fits '08-later Softail models (except FXCW, FXCWC, FXSB, FXSBSE and FXST-Aus).

<b>43468-00</b>		<b>\$34.95</b>
-----------------	--	----------------

Fits '00-'07 Softail models (except FLSTF, FXSTD and models with Passenger Footboard Kit).

<b>43830-96</b>		<b>\$34.95</b>
-----------------	--	----------------

Fits '84-'99 Softail models. (Does not fit FLSTS.)

## G. UPPER SWINGARM COVER KIT – CHROME

Give chrome the upper hand with this chrome die-cast cover for your upper swingarm. Mounts easily with all necessary hardware included. Then continue your rear end chrome with a rear axle cover.

<b>47059-01</b>		<b>\$94.95</b>
-----------------	--	----------------

Fits '00-'07 Softail models (except FXSTD and FLSTFSE2).

SOFTAIL

Notice: The prices appearing in this catalog are the manufacturer's suggested retail prices. Actual retail prices may vary.

# 298 SOFTAIL®

Chassis Trim – Rear End

## A. BAR & SHIELD REAR AXLE COVERS

Add a sweep of chrome to the rear of the swingarm. This mirror-finished cover hides the axle head and the rear of the swingarm (sold in pairs).

**42069-08** \$109.95

Fits '08-later Softail® models (except FXCW, FXCWC, FXSB, FXSBSE, FLSTF and FLSTFB). Will not fit with saddlebags.

**44345-09** \$99.95

Fits '08-later FXCW and FXCWC models. Will not fit with saddlebags.



A. BAR & SHIELD REAR AXLE COVERS  
(42069-08 SHOWN)



A. BAR & SHIELD REAR AXLE COVERS  
(44345-09 SHOWN)

## B. REAR AXLE COVERS

Traditional wedge-shaped rear axle covers follow the triangular lines of the Softail swingarm and conceal the swingarm tail for a clean, custom look. Available in your choice of mirror chrome or rich gloss black finish, these complete kits include left and right covers, complementing trim discs and all required mounting hardware.

Fits '87-'07 Softail models (except FLSTS). Will not fit with saddlebags.

**47596-91B** Chrome. \$99.95

**47615-95B** Gloss Black. \$99.95

## C. "HARLEY-DAVIDSON" SCRIPT REAR AXLE COVERS

Add a sweep of chrome over the rear axle nut with this stylish rear axle cover. This mirror-finish kit covers the axle nut and adjuster screw, without hiding the swingarm tail. The distinctive shape and the debossed "Harley-Davidson" script combine to complement a painted or chrome-plated swingarm. Kit includes all necessary mounting hardware.

**41575-08** \$204.95

Fits '08-later Softail models (except FXCW, FXCWC, FXSB and FXSBSE models). Will not fit with saddlebags.

## D. PISTON REAR AXLE COVER AND ADJUSTER

Simple, clean chrome-plated styling to add brilliance to your rear axle adjuster.

**48180-98B** \$69.95

Fits '86-'07 Softail models (except '06-'07 FXST, FXSTB, FXSTS, FLSTFSE2 and '07 FLSTF). (Will not fit with saddlebags.)



B. REAR AXLE COVERS – GLOSS BLACK



B. REAR AXLE COVERS – CHROME



C. "HARLEY-DAVIDSON" SCRIPT REAR  
AXLE COVERS



D. PISTON REAR AXLE COVER AND ADJUSTER

*Notice: The prices appearing in this catalog are the manufacturer's suggested retail prices. Actual retail prices may vary.*



# SOFTAIL® 299

Chassis Trim – Rear End



**E. REAR AXLE NUT COVERS – CHROME BILLET**



**E. REAR AXLE NUT COVERS – GLOSS BLACK BILLET**



**F. REAR AXLE NUT COVERS – “H-D MOTOR CO.” LOGO**



**G. REAR AXLE NUT COVERS – WILLIE G SKULL**



**H. REAR AXLE ADJUSTER HARDWARE – CHROME**



**I. REAR WHEEL SPACER KIT – CHROME, STRAIGHT**



**I. REAR WHEEL SPACER KIT – CHROME, TAPERED**

## E. REAR AXLE NUT COVERS

Cover your rear axle nut in the most traditional way. This Rear Axle Cover Kit complements the matching Front Axle Nut covers. Easy to install, these cover kits include necessary mounting hardware. Sold in pairs.

Fits '08-later Dyna® and Softail® models (except FXCW, FXCWC, FXSB, FXSBSE and FXST-Aus).

<b>43132-08</b>	Chrome – Billet.	<b>\$42.95</b>
<b>41705-09</b>	Chrome – Die-cast.	<b>\$27.95</b>
<b>43422-09</b>	Gloss Black – Billet.	<b>\$42.95</b>

Fits '00-'07 Softail models (except FLSTS and FLSTSC). (Will not fit with saddlebags.)

<b>44256-01</b>	Chrome – Die-cast.	<b>\$27.95</b>
-----------------	--------------------	----------------

## F. REAR AXLE NUT COVERS – “H-D MOTOR CO.” LOGO

Cover your rear axle nut in the most traditional way. This Rear Axle Cover Kit complements the matching Front Axle Nut covers. Easy to install, these cover kits include necessary mounting hardware. Sold in pairs.

**41704-09**  
Fits '08-later Dyna and Softail models (except FXCW, FXCWC, FXSB, FXSBSE and FXST-Aus).

**44254-01**  
Fits '00-'07 Softail models (except FLSTS and FLSTSC). (Will not fit with saddlebags.)

## G. REAR AXLE NUT COVERS – WILLIE G SKULL

Cover your rear axle nut in the most traditional way. This Rear Axle Cover Kit complements the matching Front Axle Nut covers. Easy to install, these cover kits include necessary mounting hardware. Sold in pairs.

**41706-09**  
Fits '08-later Dyna and Softail models (except FXCW, FXCWC, FXSB, FXSBSE and FXST-Aus).

**43221-08** Fits '00-'07 later Softail models. **\$34.95**

## H. REAR AXLE ADJUSTER HARDWARE – CHROME

Highly polished and chrome-plated hex-head bolts replace the standard hardware for a custom look. Manufactured to Original Equipment specifications to ensure fit and performance, this kit is the perfect addition to a chrome or painted swingarm.

**41202-08** Fits '08-later Softail models. **\$15.95**

## I. REAR WHEEL SPACER KIT – CHROME

Add some chrome detail to an often overlooked area of the bike with this highly-polished Chrome Wheel Spacer Kit. Manufactured to the Original Equipment tolerances, they ensure product fitment and quality.

**41221-08** Tapered. **\$29.95**  
Fits '12-later FLS models without ABS. Also fits '08-'13 Softail models (except FXCW, FXCWC, FXSB, FXSBSE and models with ABS brakes).

**41596-00A** Straight. **\$29.95**  
Fits '00-'07 Softail models (except '06 FXST, FXSTB, FXSTS and FLSTFSE2). Does not fit with Wide Tire Kit P/N 43685-00 and 44490-00.

SOFTAIL

Notice: The prices appearing in this catalog are the manufacturer's suggested retail prices. Actual retail prices may vary.

# 300 SOFTAIL®

Chassis Trim – Rear End

## A. CONTOURED FRAME INSERTS

Add a custom “filled and molded” look to the Softail® frame. These Contoured Frame Inserts are shaped to fill the frame recesses that surround the swingarm pivot bolt. The smooth teardrop shape blends with the frame for maximum impact. These inserts complement both a black-painted or chrome-plated swingarm installation. Adhesive backed for easy installation.

**48211-08** Chrome. **\$64.95**  
Fits '08-later Softail models (except FXCW, FXCWC, FXSB, FXSBSE and FXST-Aus).

**48212-08** Chrome. **\$64.95**  
Fits '08-later FXCW, FXCWC, FXSB and FXSBSE models.

## B. SOFTAIL® FRAME TRIM SET

Easy-to-install chrome-plated trim plates fit into recesses on rear of Softail frame near swingarm pivot. Comes with double-sided adhesive tape. Adds a finishing touch. (Shown with Chrome Swingarm Pivot Cover P/N 43897-86B, sold separately.)

**47300-88T** **\$27.95**  
Fits '84-later Softail models (except '00-later FLSTF, FLSTFB, FLSTN, FLSTSB and FXSTD models equipped with shotgun exhaust).

## C. SWINGARM FRAME COVER KIT

This easy-to-install Swingarm Frame Cover Kit adds a flash of chrome around the swingarm pivot. The frame cover is mounted with a self-adhesive custom molded rubber backing that hugs the contour of the frame for a snug, custom fit. Kit includes chrome pivot bolt covers to complete the look.

**48494-03** **\$65.95**  
Fits '00-'06 FXSTD and FLSTF models with stock shotgun exhaust.

## D. SOFTAIL FRAME INSERT AND PIVOT BOLT KIT

Chrome rear frame inserts get you going on the road toward the perfect Softail. Kit includes Swingarm Pivot Bolt Covers and Frame Inserts. Easy installation kit.

**48452-00** **\$40.95**  
Fits '00-'07 FLSTF, FLSTN and FXSTD (except FXSTDSE) models.



A. CONTOURED FRAME INSERTS



B. SOFTAIL FRAME TRIM SET



C. SWINGARM FRAME COVER KIT



D. SOFTAIL FRAME INSERT AND PIVOT BOLT KIT

*Notice: The prices appearing in this catalog are the manufacturer's suggested retail prices. Actual retail prices may vary.*



# SOFTAIL® 301

Chassis Trim – Rear End



**E. MAGNUM 5 SPROCKET COVER – CHROME**



**E. MAGNUM 5 SPROCKET COVER – GLOSS BLACK**



**F. TYPHOON SPROCKET COVER – CHROME**



**F. TYPHOON SPROCKET COVER – GLOSS BLACK**



**G. SPROCKET COVER – CHROME**



**H. SPROCKET COVER WITH HOLES**



**I. REAR SPROCKET BOLT COVER KIT**



**J. SPROCKET HARDWARE – CHROME HEX HEAD**

## E. MAGNUM 5 SPROCKET COVER

Styled to match the distinctive Magnum 5 Custom Wheel. Available in mirror chrome or gloss black, this Sprocket Cover gives the appearance of having a custom sprocket at a fraction of the cost. Cover is easy to install with Original Equipment hardware or add the Chrome Hardware Kit P/N 94773-07 (sold separately) to your Softail® model for a finished look.

Fits '07-later Softail (except FLSTNSE, FXCW, FXCWC, FXSB and FXSBSE).

<b>42200011</b>	Gloss Black.	<b>\$54.95</b>
<b>40121-09</b>	Chrome.	<b>\$54.95</b>

## F. TYPHOON SPROCKET COVER

Styled to match the distinctive Typhoon Custom Wheel. Available in mirror chrome or gloss black, this Sprocket Cover gives the appearance of having a custom sprocket at a fraction of the cost. Cover easily bolts on using the stock hardware or for a finished look, add the Chrome Hardware Kit P/N 94773-07 (sold separately).

Fits '07-later Softail (except FLSTNSE, FXCW, FXCWC, FXSB and FXSBSE).

<b>42200013</b>	Gloss Black.	<b>\$49.95</b>
<b>40150-08</b>	Chrome.	<b>\$49.95</b>

## G. SPROCKET COVER – CHROME

This Sprocket Cover gives the appearance of having a chrome sprocket at a fraction of the cost. It matches the styling of the Original Equipment sprocket and bolts on using the stock hardware.

**37757-07** **\$49.95**

Fits '07-later Softail (except FLSTNSE, FXCW, FXCWC, FXSB and FXSBSE).

<b>91347-00</b>	Fits '00-'06 Softail models.	<b>\$49.95</b>
-----------------	------------------------------	----------------

## H. SPROCKET COVER WITH HOLES

This handsome steel cover is polished and chrome-plated. Easy to install. Looks great when combined with Harley-Davidson® chrome belt guard.

**91733-85A** **\$54.95**

Fits '91-'99 Dyna® models. Also fits '80-'99 U.S. 1340 models except '93 and '95-'99 Softail models. '94 U.S. Softail models are equipped with 70-tooth rear sprockets. Also fits '94-'99 International 1340 models (except International Softail and Swiss 1340 models).

## I. REAR SPROCKET BOLT COVER KIT

These chrome-plated covers with internal spring clips hide the Original Equipment sprocket bolts for a clean, custom look. Set of 5 covers.

**43876-04** **\$38.95**

Fits '93-later Softail, '99-later Touring and '04-later XL models with Original Equipment 7/16" hex head sprocket mounting bolts (5/8" hex across the flats).

## J. SPROCKET HARDWARE – CHROME HEX HEAD

This kit includes highly-polished, chrome-plated, grade 8 hex-head screws with chrome-plated washers, providing an extra custom accent. The perfect addition to the new chrome sprocket. Made from the same Original Equipment bolts to ensure product integrity. Also works with chrome belt sprocket covers and Original Equipment sprockets.

**94773-07** **\$29.95**

Fits '07-later Dyna and Softail models.

**94773-00A** **\$29.95**

Fits '00-'06 Softail and '00-'05 Dyna models.

**94708-98** **\$29.95**

Fits '93-'99 Softail, '93-'99 Dyna and '91-later XL models.

*Notice: The prices appearing in this catalog are the manufacturer's suggested retail prices. Actual retail prices may vary.*

## 302 SOFTAIL®

Chassis Trim – Brakes

### A. BRAKE CALIPER KIT – RED

Dress your bike in the latest high-performance look. Brilliant red calipers make a powerful visual statement and set your bike apart from the ordinary. Manufactured from Original Equipment components for proven performance, these calipers will add a stylish touch to the stock bike or add the perfect finish to a complete custom equipped with chrome or blacked-out wheels, rotors and fork sliders. (Brake pads not included.)

**41300127** Front & Rear Kit. **\$399.95**

Fits '08-later Dyna® and '08-'14 Softail® models (except Springer™) equipped with single disc front brakes. Kit includes one front and one rear caliper. Includes brake pads.

**41300126** Front – Single Disc. **\$249.95**

Fits '00-'03 XL, '00-'07 Dyna and '00-'07 Softail models with single disc front brakes. Brake pads sold separately.



A. FRONT BRAKE CALIPER KIT – RED



A. REAR BRAKE CALIPER KIT – RED



A. BRAKE CALIPER KIT – RED  
(41300127 SHOWN)

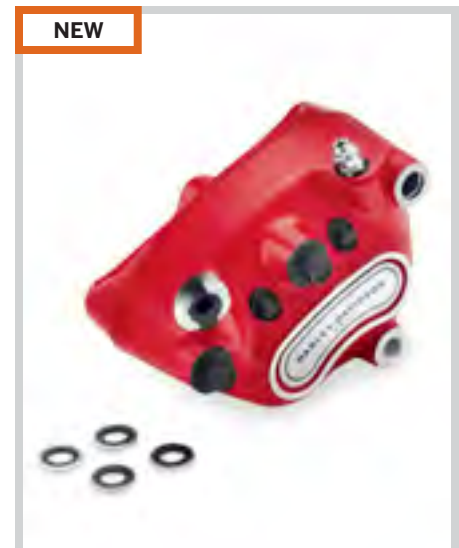

A. BRAKE CALIPER KIT – RED  
(41300126 SHOWN)

*Notice: The prices appearing in this catalog are the manufacturer's suggested retail prices. Actual retail prices may vary.*



# SOFTAIL® 303

Chassis Trim – Brakes



**B. FRONT BRAKE CALIPER KIT – CHROME**  
(SHOWN WITH CLASSIC CHROME CALIPER  
INSERT)



**B. FRONT BRAKE CALIPER KIT – CHROME**  
(44395-08 SHOWN)



**B. FRONT BRAKE CALIPER KIT – CHROME**  
(44392-00A SHOWN)



**B. REAR BRAKE CALIPER KIT – CHROME**  
(SHOWN WITH CHROME REAR CALIPER  
BRACKET)



**B. REAR BRAKE CALIPER KIT – CHROME**  
(‘00-‘07 MODELS SHOWN)



**C. CUSTOM CALIPER BOLT COVER KIT**



## B. BRAKE CALIPER KIT – CHROME

Add the shine of chrome to your front end with this highly polished Chrome Front Brake Caliper Kit. Manufactured from Original Equipment components for proven performance, these calipers are a great addition to the stock front end or add the finishing touch to a complete custom with chrome wheels, rotors and chrome fork sliders. (Brake pads and pad pins not included.)

**44395-08** Front – Single Disc. **\$389.95**  
Fits '08-later Dyna® (except '14-later FXDL) and '08-'14 Softail® models (except Springer™) equipped with single disc front brakes.

**44395-00A** Front – Single Disc. **\$389.95**  
Fits '00-'03 XL and '00-'07 Dyna and Softail (except Springer) models equipped with single disc front brakes.

**44392-00A** Front – Dual Disc. **\$799.95**  
Fits '00-'03 XL, '02-'05 VRSC™ and '00-'07 Dyna, Softail and Touring models equipped with dual disc front brakes.

**42047-08** Rear. **\$349.95**  
Fits '08-later Dyna and Softail models.

**44539-02A** Rear. **\$419.95**  
Fits '00-'07 FL Softail (except '07 FLSTF), '00-'05 FX Softail (except FXSTD) and '02-'04 VRSC models. Not for use with accessory Wide Tire Kits.

### Shown with:

#### REAR CALIPER BRACKET – CHROME

Complete a chrome rear brake conversion. This Rear Caliper Bracket sets your ride apart from the others by replacing the painted black mount with brilliant chrome. Manufactured from the Original Equipment components for exact fit, this mount will bolt to the existing mounting location.

**42048-08** Fits '08-later Softail models. **\$119.95**

## C. CUSTOM CALIPER BOLT COVER KIT

Cover your 12-point caliper bolts in chrome. These easy-to-install chrome covers are held firmly in place with a steel spring clip and are styled to match the Chrome Rocker Box Bolt and Headbolt Covers.

**43824-03** Four Large Covers. **\$23.95**  
Fits '00-later front and rear 12-point caliper mounting bolts (except Springer front calipers, '15-later XG, '08-later Touring, '08-later Trike and '06 VRSCR models).

**40955-05** Four Large and Two Small Covers. **\$28.95**  
Fits '00-later front brake calipers (except Springer models, '15-later XG, '04-later XL models, '08-later Touring, '08-later Trike, '06-later VRSC models and models equipped with caliper covers). Also fits rear calipers on '06-later Softail models (except FXCW).

**40959-05** Three Large and Two Small Covers. **\$23.95**  
Fits '00-later rear brake calipers (except '15-later XG, '04-later XL models, '08-later Touring, '08-later Trike, '06-later FXST, FXSTB, FXSTS and FLSTSB, '06-later VRSC models and models equipped with caliper covers).

SOFTAIL

Notice: The prices appearing in this catalog are the manufacturer's suggested retail prices. Actual retail prices may vary.

# 304 SOFTAIL®

## Chassis Trim – Brakes

### A. CALIPER COVER – CHROME

Chrome-plated caliper covers styled with stepped contours and textured recess for a distinctive look. Does not require brake line removal.

**43759-00** Front. **\$42.95**  
Fits left-hand calipers on '00-'07 FXDWG and '00-'07 Softail® models (except Springer™ and FXSTD models). Will not fit with braided brake lines.

**43553-00** Rear. **\$38.95**  
Fits '00-'05 Dyna® and '00-'07 Softail models (except '06-'07 FXST, FXSTB, FXSTS, FLSTFSE2 and '07 FLSTF). (Will not fit with braided brake lines.)



A. FRONT CALIPER COVER – CHROME



A. REAR CALIPER COVER – CHROME

### B. BANJO BOLT KIT – CHROME

Replace the Original Equipment 12-point zinc finish brake line hardware with brilliant chrome custom tapered banjo bolts.

**41842-06** **\$29.95**  
Fits '91-'03 XL, '91-later Dyna (except FXDF), '95-'14 Softail and '99-'00 FXR models equipped with single front brake. Does not fit on the Dyna or Softail ABS Hydraulic Control Unit or with Banjo Bolt Cover P/N 32715-98. Kit includes one 7/16" banjo bolt, three 3/8" banjo bolts and eight sealing washers.



B. BANJO BOLT KIT – CHROME

### C. BRAKE BLEEDER AND BANJO BOLT COVERS

#### 1. Brake Bleeder Screw Cover

This cover adds chrome to the unfinished bleeder valve on all stock H-D® calipers. Package of two.

**43834-98** **\$23.95**  
Fits '84-later stock calipers (except XR models).

#### 2. Chrome Banjo Bolt Cover

Die-cast chrome cover provides a custom look to your stock banjo bolts. Fits banjo bolts on front and rear brake master cylinders and front and rear calipers. Installs in seconds.

**32715-98** **\$21.95**  
Fits '84-later models with stock master cylinders and calipers. (Does not fit VRSC™ Rear Master Cylinder, '06-later VRSC calipers, '15-later XG, '08-later Touring and Trike or '04-later XL models.)



C. BRAKE BLEEDER AND BANJO BOLT COVERS

### D. BRAKE CALIPER TRIM DISCS

Available in 1-3/8" and 1-3/4" diameters to accommodate front and rear calipers on most '99-earlier models and front calipers on '00-later Springer models. Easy to install.

- 1. 44095-96** "H-D Motor Co." – 1.375" Diameter. **\$16.95**
- 44093-96** "H-D Motor Co." – 1.75" Diameter. **\$16.95**
- 2. 99661-92T** Gold Live to Ride – 1.375" Diameter. **\$16.95**
- 99663-92T** Gold Live to Ride – 1.75" Diameter. **\$16.95**
- 3. 99679-98** Flames – 1.375" Diameter. **\$11.95**



D. BRAKE CALIPER TRIM DISCS

### E. CALIPER HARDWARE KIT – CHROME

Chrome-plated hardware is a great finishing touch to chrome Brake Calipers. This kit replaces the Original Equipment black 12-point bolts on a single caliper.

**44473-02A** **\$44.95**  
Fits '00-'07 models (except Springer front caliper, '04-later XL, '06-later FX Softail rear calipers and '06-later VRSC models).



E. CALIPER HARDWARE KIT – CHROME

*Notice: The prices appearing in this catalog are the manufacturer's suggested retail prices. Actual retail prices may vary.*



# SOFTAIL® 305

Chassis Trim



**F. BRAKE CALIPER INSERT — DEEP DISH**



**F. BRAKE CALIPER INSERTS**

**F. BRAKE CALIPER INSERTS**

Easy-to-install inserts add a finishing touch to the front and rear brake calipers. Select a style that follows your custom direction. Self-adhesive backing.

Fits '00-later front and rear brake calipers on all models (except Springer™ front, '08-later Touring, '08-later Trike, '04-later XL, '15-later XG and '06-later VRSC™ models).

<b>1. 44542-03</b>	Deep Dish.	<b>\$16.95</b>
<b>2. 44477-99</b>	Classic Chrome.	<b>\$16.95</b>
<b>3. 44476-99</b>	"Harley-Davidson" Script.	<b>\$16.95</b>
<b>4. 44474-99</b>	Flames.	<b>\$16.95</b>

**G. SEAT POST – CHROME**

Finish your bike down to the last detail. This mirror-polished and chrome-plated seat post replaces the Original Equipment black painted post and adds a dash of chrome from the seat base to the engine. Kit includes chrome mounting hardware.

<b>48875-07</b>		<b>\$69.95</b>
Fits '07-later Softail® models (except FXCW, FXCWC, FXS, FXSB, FXSBSE and FXSTSSE3).		



**G. SEAT POST – CHROME**



**G. SEAT POST – CHROME**

**H. REAR FENDER STRUT HARDWARE KIT – CHROME**

Finish the show-winning look with brilliant chrome hardware. Manufactured to Original Equipment specifications, these kits replace the zinc-plated exposed fender strut hardware with chrome-plated button head screws and custom machined washers.

<b>94691-08</b>	Fits '08-later FLSTC models.	<b>\$34.95</b>
<b>94692-08</b>		<b>\$49.95</b>
Fits '08-later FXSTB, FLSTSB and FXSTSSE2/3 models.		
<b>94693-08</b>		<b>\$54.95</b>
Fits '08-later FLSTN models (except FLSTNSE).		
<b>94694-08</b>	Fits '08-later FXSTC models.	<b>\$44.95</b>
<b>94560-07</b>	Fits '07 FLSTC models.	<b>\$34.95</b>
<b>94561-07</b>		<b>\$44.95</b>
Fits '06-'07 FXST, FXSTB, FXSTS, FLSTFSE2 and '07 FLSTF, FXSTSSE models.		
<b>94562-07</b>		<b>\$54.95</b>
Fits '05-'07 FLSTSC, '06 FLST and '07 FLSTN models.		
<b>94416-05</b>		<b>\$44.95</b>
Fits '03-'05 FXST, FXSTB and FXSTS models, '03-'06 FLSTF and '05-'06 FLSTN models (shown).		



**H. REAR FENDER STRUT HARDWARE KIT – CHROME**

SOFTAIL

*Notice: The prices appearing in this catalog are the manufacturer's suggested retail prices. Actual retail prices may vary.*

# 306 SOFTAIL®

Chassis Trim

## A. MID-FRAME COVER KIT

Chrome-plated Mid-Frame Cover stretches from the fuel tank to the fender strut to conceal the painted frame rails. This easy-to-install bolt-on kit includes left and right side covers and all necessary mounting hardware.

**47245-05** **\$99.95**  
Fits '00-'07 FXSTD, FLSTC and FLSTF models.

## B. FRONT FUEL TANK MOUNTING HARDWARE KIT – CHROME

Beauty lies in the details. And this chrome-plated Fuel Tank Mounting Hardware Kit ensures you won't leave this one overlooked. The perfect finishing touch to your fuel tank, the kit includes the machined washers and custom nuts required for your model.

**62965-01** **\$29.95**  
Fits '00-later Softail® models (except FLSTSE/2/3, FLSTNSE and FXSBSE).

## C. BAR & SHIELD LOGO COIL COVER

Featuring a radical open-face design with a Bar & Shield logo silhouette, this chrome coil cover matches chrome Voltage Regulator Covers P/N 74597-01, 74582-00 and 74578-97 for an integrated custom look. Includes all mounting hardware.

**74616-04** **\$39.95**  
Fits '01-later EFI equipped Softail models (except FXCW, FXCWC, FXS, FXSB, FXSBSE and FXST-Aus) and '04-later EFI equipped Dyna® models.

## D. VOLTAGE REGULATOR – CHROME

Original Equipment voltage regulators with a sparkling triple-plated chrome finish. Hand-buffed, then copper-, nickel- and chrome-plated, these brilliant chrome-plated regulators are the perfect highlight for any Harley-Davidson® motorcycle.

**74567-11** Fits '11-later Softail models. **\$149.95**

**74610-08** Fits '08-'10 Softail models. **\$149.95**

**74610-01** Fits '01-'06 Softail models. **\$149.95**

**74537-93A** **\$149.95**

Fits '89-'95 1340 models, '96 FLT, FLHT and FLHR models (except fuel injected), '96-'99 Softail and '96-'98 Dyna® models.

## E. VOLTAGE REGULATOR COVER – CHROME

With a look that creates its own electricity, this chrome-plated cover features an embossed Bar & Shield logo and an open-center grill that allows air to flow right through for regulator cooling. Designed for easy installation. Chrome mounting hardware included.

**74597-01** **\$44.95**

Fits '01-later Softail models. Will fit models equipped with Bullet Front Spoiler P/N 57039-XX. Will not fit with other Softail front spoilers.

**74582-00** **\$44.95**

Fits '00 Softail models. (Will not fit with front spoiler.)

**74578-97** Fits '89-'99 Softail models. **\$49.95**



A. MID-FRAME COVER KIT



B. FRONT FUEL TANK MOUNTING HARDWARE KIT – CHROME



C. BAR & SHIELD LOGO COIL COVER



D. VOLTAGE REGULATOR – CHROME



E. VOLTAGE REGULATOR COVER – CHROME

*Notice: The prices appearing in this catalog are the manufacturer's suggested retail prices. Actual retail prices may vary.*





**F. CLASSIC COVERS KIT (94921-09 SHOWN)**

# SOFTAIL® 307

Chassis Trim

## F. CLASSIC COVERS KIT

Customize your bike down to the last detail. These hardware Cover Kits include the chrome-plated ABS caps and plugs in the sizes and styles required to dress the viewable hardware on the motorcycle. Classic Covers are available as complete "Bike Kits" with the covers for both engine and chassis hardware or as "Engine-only" kits to dress the Twin Cam or XL engine. The kits are easy to install, with no tools required.

**94923-09** Bike Kit. **\$259.95**  
Fits '09-later Softail® models (except FXCW, FXCWC, FLS and FLSTSB).

**94948-07** Bike Kit. **\$289.95**  
Fits '00-'08 Softail models.

**94943-07** Engine Kit. **\$144.95**  
Fits Twin Cam-equipped models.

## G. HERITAGE SOFTAIL® CLASSIC REAR FENDER LEATHER MUD FLAP

Get nostalgic with top-grain cowhide decorated with bright spots and a Heritage-style concho. A perfect match with your Heritage saddlebags. Kit includes installation hardware and template.

**59071-98** Fits '86-later FLSTC models. **\$59.95**

## H. HERITAGE SPRINGER® LEATHER MUD FLAP WITH FRINGE

Made from premium, plated leather with black trim, these flaps have fringe and an '97-'03 FLSTS concho and black trim. Includes chrome hardware, support bracket and fender mounting template.

**59027-99** **\$59.95**  
Fits '97-'03 FLSTS models front or rear fender. Also fits '86-later FLSTC, '86-'06 FLSTF and '93-'96 FLSTN models.

## I. STUDED REAR FENDER MUD FLAP

Black mud flap with accenting decorative studs.

**59230-88** **\$29.95**  
Fits '08-earlier FLHT, FLHS, FLHRC, FLT, FLTR, '86-'90 FLST, '86-'06 FLSTF and '93-'96 FLSTN models. (Does not fit '09-later Touring or models with rear bumper rail.)

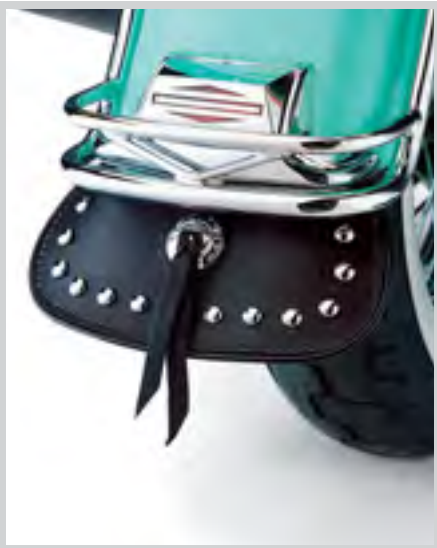

**G. HERITAGE SOFTAIL CLASSIC REAR FENDER LEATHER MUD FLAP**



**H. HERITAGE SPRINGER LEATHER MUD FLAP WITH FRINGE**

**I. STUDED REAR FENDER MUD FLAP**

*Notice: The prices appearing in this catalog are the manufacturer's suggested retail prices. Actual retail prices may vary.*

GENUINE MOTOR PARTS &amp; ACCESSORIES



2015

## TOURING & TRIKE

There's no better way to eat up the highway miles—be it on a wide-open two-lane or busy interstate—than on a Touring family motorcycle. Unmatched comfort, performance, and style to take you as far as you want to go.







TOURING

# WHAT'S NEW

For 2015, we've taken what was always great about the Harley-Davidson® Road Glide® model and made it even better. The sleek new frame-mounted fairing delivers a streamlined look and more "open" feel, even as it provides improved wind protection. New adjustable vents let you shape the wind to match your ride—just one of the many ways you can make this incredible bike your own.

FLTRXS | PRODUCTION COLOR: SUPERIOR BLUE



TRAVEL-PAK  
TOUR-PAK® LINER

ROAD ZEPPELIN®  
AIR ADJUSTABLE SEAT

BOOM!™ AUDIO  
SADDLEBAG LID SPEAKERS

CHOPPED TOUR-PAK®  
LUGGAGE

H-D® DETACHABLES™  
TOUR-PAK® RACK

SCREAMIN' EAGLE®  
STREET THUNDER MUFFLERS

BOOM!™ AUDIO  
AMP & SPEAKER KIT

COLOR-MATCHED  
INNER FAIRING

CHROME HAND  
CONTROLS

12" WIND SPLITTER  
WINDSHIELD

ROAD GLIDE®  
WINDSHIELD TRIM

BOOM!™ AUDIO  
HIDDEN ANTENNA

WIND DEFLECTORS

CHROME FRONT END KIT

VENTILATOR ELITE  
AIR CLEANER

STEALTH FOOT CONTROLS

DAYMAKER™  
LED FOG LAMPS

AGGRESSOR WHEELS & ROTORS





TOURING

## ROAD KING®

FLHR | PRODUCTION COLOR: VIVID BLACK

This menacing Road King® motorcycle rules with an iron fist. The Black Ice Agitator wheels lead the way and connect the rider to the road through a blacked-out front end and 16" Fat Ape bar\*. From the Street Stalker™ front fender to the tip of the CVO™ model-style rear fender, a Dark Custom™ attitude reigns, and bright red calipers lend a regal touch.

SEE WHAT'S ON THIS BIKE AT [H-D.COM/GALLERY](https://www.harley-davidson.com/gallery)

\*Handlebar height is regulated in many areas. Check local laws before installing.





TOURING

## ULTRA CLASSIC®

FLHTCU | PRODUCTION COLOR: MYSTERIOUS RED SUNGLO

Touring practicality and hot-rod style in one. Geared up for the road, this bike's Sundowner™ seat and 8-speaker BOOM!™ Audio sound system will keep you comfortable and entertained for hours in the saddle. And when you reach your destination, pop off the detachable Tour-Pak® luggage, twist the throttle, and prowl the streets in stripped-down style.

SEE WHAT'S ON THIS BIKE AT [H-D.COM/GALLERY](http://H-D.COM/GALLERY)





TOURING

**ULTRA CLASSIC® LOW**

FLHTCUL | PRODUCTION COLOR: AMBER WHISKEY/CHARCOAL PEARL

At first glance, this beautiful Ultra Low looks understated and elegant. But when the sun goes down and the lights come on, its true personality shines. LED headlamp and fog lamps light the road ahead, and LED saddlebag side and rear marker lighting commands the attention it deserves – especially from those lucky enough to be following along.

SEE WHAT'S ON THIS BIKE AT [H-D.COM/GALLERY](https://www.harley-davidson.com/gallery)





TOURING

## ULTRA LIMITED

FLHTK | PRODUCTION COLOR: SUPERIOR BLUE

Luxury, style and performance—all the requirements of a couple traveling together. Unparalleled comfort from the Hammock seat and passenger armrests. Striking chrome accents. Non-stop entertainment from the 6-speaker BOOM!™ Audio sound system. Breathtaking acceleration with Screamin' Eagle® performance upgrades. This machine has it all.





TOURING

## ULTRA LIMITED LOW

FLHTKL | PRODUCTION COLOR: DEEP JADE PEARL / VIVID BLACK

Luxury touring within almost any rider's reach. The low-profile suspension puts the rider closer to the ground. With a sleek Wind Splitter windscreen, blacked-out finishes, LED lighting, and premium 6-speaker BOOM!™ Audio sound system, there are no shortcuts when it comes to style.

SEE WHAT'S ON THIS BIKE AT [H-D.COM/GALLERY](https://www.harley-davidson.com/gallery)





TOURING

## STREET GLIDE®

FLHX | PRODUCTION COLOR: MYSTERIOUS RED SUNGLO

Hit the country road if you want to, but this sleek Street Glide® model is just as eager to play with the urban crowd. Rich blacked-out finishes play in perfect harmony with the Mysterious Red, and the BOOM!™ Audio sound system and Street Cannon mufflers provide a silky soundtrack. Just relax in the Road Zeppelin® saddle, and turn up the volume.

SEE WHAT'S ON THIS BIKE AT [H-D.COM/GALLERY](https://www.harley-davidson.com/gallery)

Handlebar height is regulated in many areas. Check local laws before installing.





TOURING

## STREET GLIDE® SPECIAL

FLHX | COLORSHOP CUSTOM PAINT: LIMITED - ARCTIC FLASH

Black, white, and red all over. A blend of well-chosen extras help make this Street Glide® Special motorcycle something extra special. Color Shop Arctic Flash paint gets things started, and contrasting silver and black Agitator wheels and Burst Collection components finish the look. Then we tie it all together with complementing red brake calipers.

SEE WHAT'S ON THIS BIKE AT [H-D.COM/GALLERY](https://www.harley-davidson.com/gallery)





TOURING

## ROAD GLIDE®

FLTRX | COLORSHOP CUSTOM PAINT: LIMITED - MIDNITE BLAZE

The Road Glide® motorcycle returns with a new look and a fresh attitude. This custom beauty features Midnite Blaze paint that sets the stage for blacked-out Agitator wheels, forks and engine trim, and then ups the ante with premium 4-speaker BOOM!™ Audio and Screamin' Eagle® performance upgrades. This is hot-rod bagger style at its finest.

SEE WHAT'S ON THIS BIKE AT [H-D.COM/GALLERY](https://www.harley-davidson.com/gallery)





TOURING

## ROAD GLIDE® SPECIAL

FLTRXS | COLORSHOP CUSTOM PAINT: LIMITED-ARCTIC FLASH

Hit the road in glorious solitude. Stripped bare, this solo ride attracts attention wherever it goes. The blend of dark and light flows from the Color Shop Arctic Flash paint and continues to the contrast cut Burst Collection engine and chassis trim. But add a passenger pillion and the Chopped Tour-Pak® luggage, and you will never be alone again.

SEE WHAT'S ON THIS BIKE AT [H-D.COM/GALLERY](https://www.harley-davidson.com/gallery)





TOURING

## FREEWHEELER™

FLRT | PRODUCTION COLOR: AMBER WHISKEY

Introducing the H-D® Freewheeler™ trike, the sleekest, sexiest three-wheeler around. This version sports a practical detachable windshield, Sundowner™ touring seat, passenger backrest and luggage rack, along with stylish chrome forks, blacked-out engine trim, and a raft of brilliant LED lighting. You'll stand out in a crowd wherever you ride.

SEE WHAT'S ON THIS BIKE AT [H-D.COM/GALLERY](https://www.harley-davidson.com/gallery)



TOURING

**TRI GLIDE® ULTRA**

FLHTCUTG | PRODUCTION COLOR: VIVID BLACK

Vivid Black and chrome set the tone for this elegant Tri Glide® model, delivering high-end luxury in a three-wheeled package. Start with a heated Harley® Hammock touring seat. Add BOOM!™ Audio amp and speakers. Dress it up with Anarchy contrast chrome wheels. Layer on the chrome accents. And drive it home with LED headlamps and accent lighting.





**STREET GLIDE® SPECIAL TRANSFORMATION**

**GREEN WITH ENVY**

If you're looking for stripped-down bagger style, highway comfort, and modern technology, the Street Glide® Special motorcycle delivers it all—with a decidedly unruly attitude.

This sweet Street Glide® Special motorcycle is all about blurring the lines between a classic touring bike and hot-rod bagger. It starts with the rich Deep Jade Green finish that carries all the way through to the color-matched batwing inner fairing and stretched BOOM!™ Audio saddlebags.

It builds when everything else is dipped in chrome—from the Aggressor wheels and fork sliders to the tip of the Mini-Ape Handlebar® and the Nightstick exhaust. And it's finished with the addition of removable Chopped Tour-Pak® luggage. Only then do you get to see the complete picture.



CHOPPED TOUR-PAK® LUGGAGE

STRETCHED BOOM!™ AUDIO SADDLEBAGS

SCREAMIN' EAGLE® NIGHTSTICK MUFFLERS

BOOM!™ AUDIO SADDLEBAG SPEAKERS

RALLYRUNNER SEAT®

VENTILATOR ELITE AIR CLEANER

SLIPSTREAM FOOT CONTROL

SLIPSTREAM GRIPS & MIRRORS

WIND SPLITTER WINDSHIELD

BOOM!™ AUDIO AMP & SPEAKERS

CHROME FRONT END KIT

AGGRESSOR WHEELS & ROTORS

\*Handlebar height is regulated in many areas. Check local laws before installing.



FIT

Parts list available at [h-d.com/gallery](http://h-d.com/gallery)

Throw your fists to the wind with the Mini-Ape Handlebar®. Shaped to rest your hands just above the top of the classic batwing fairing, these bars feature a tall stance and minimal amount of pull back that help to achieve a cool yet comfortable riding profile.



FUNCTION

From a solo ride to work to a two-up ride across the country, the Street Glide® model can be anything you want it to be. With the turn of a thumbscrew, you change the seat—from the twist of the H-D® Detachables™ cam lock, you can install a backrest or Tour-Pak® luggage.



STYLE

Chrome is king. The wide-open Aggressor wheels and rotors add lightness to this Street Glide® model's profile, and focus your eye on the brilliant finish on the Twin Cam engine and Slipstream hand and foot controls.



PERFORMANCE

The Screamin' Eagle® Ventilator Elite air cleaner and Nightstick 2-into-2 mufflers work together to pass a large volume of air through the 103HO Twin Cam engine—delivering maximum performance and an aggressive exhaust note.



CARE AND MAINTENANCE

While it's tempting to use standard "auto parts store" cleaning and service supplies, hold out for the real thing. Genuine Harley-Davidson® coolant, oils, filters, batteries and service parts are engineered for the unique surfaces and operating conditions your Harley® motorcycle will encounter.



LIGHTED SADDLEBAG LID SPOILERS



AGGRESSOR WHEELS & BRAKE ROTORS



CRAFTSMANSHIP

We design and build the bikes, so we don't need to "reverse-engineer" parts to try and make them fit. Everything we make is rigorously tested to ensure it meets our high standards, and the finishes of our accessories match the bike's surfaces for a consistent appearance.



H-D® DETACHABLES™ PASSENGER BACKREST



BOOM!™ AUDIO BAGGER & SPEAKER KIT

## 336 TOURING & TRIKE

Windshields – Road King®

### A. WIND SPLITTER VENTED WINDSHIELD

Reduce helmet buffeting at speed. The Harley-Davidson® Detachables™ Wind Splitter Vented Windshield features an exclusive fingertip-adjustable center vent that reduces turbulence behind the windscreen. When open, the controlled airflow fills the negative pressure area behind the shield and helps to smooth the flow of air over the top of the screen and around the rider. The revised flow reduces helmet bobbing and neck fatigue so you can comfortably spend more time in the saddle. The open vent also provides cooling airflow to the rider at low speeds and in city traffic.

Engineered to provide the riding comfort of a larger windshield, this low-profile screen's contemporary contour sets it apart from the crowd. The shape keeps the windshield below your site line so you don't look through bugs and road grime and the detachable design means you can ride without the shield when the mood strikes. The shield is formed of hard-coated polycarbonate for strength and scratch resistance and the dark-smoked finish reduces glare. The slim polished stainless steel brackets mount to the Original Equipment rubber isolated docking points for ease of installation and removal.

**57400176** **\$429.95**

Fits '94-later Road King® models (except FLHRS). Does not fit with Mini Tach or Boom!™ Audio Cruiser Speakers Stock on '13-'14 FLHRSE. Windshield dimensions: Overall height – 22.4" height from headlamp opening – 16.1", width – 20.3".

### B. VENTILATOR KING-SIZE H-D® DETACHABLES™ WINDSHIELD

In a nutshell, a windshield should provide a barrier between the rider and errant bugs, discarded cigarette butts, flying debris and bad air. The shield should manage airflow and wind blasts to create a pocket of still air for both rider and passenger comfort. But if you ride in a warm climate or spend time at low speeds stuck in traffic, you need to keep some air circulating around your body to stay comfortable. The Ventilator Windshield features clear injection-molded vents that allow you to adjust the airflow to match the riding conditions. Opening the vents redirects the air across your chest for a cooling effect and closing the vents provides maximum wind and weather protection. But when you want to ride "naked," the detachable shield can be removed completely and reinstalled in seconds to match your riding mood.

**57400024** 21" Clear. **\$379.95**

Fits '94-later Road King models. Will fit '04-later FLHRS models with the additional purchase of Mounting Hardware Kit P/N 58221-04. Windshield dimensions: Overall height – 28.0"; width – 22.0".



A. WIND SPLITTER VENTED WINDSHIELD



B. VENTILATOR KING-SIZE H-D DETACHABLES WINDSHIELD

*Notice: The prices appearing in this catalog are the manufacturer's suggested retail prices. Actual retail prices may vary.*



# TOURING & TRIKE 337

Windshields – Road King®



**C. ROAD KING H-D DETACHABLES WINDSHIELD – CLEAR**

## C. ROAD KING® H-D® DETACHABLES™ WINDSHIELDS

Designed to be installed or removed without tools in seconds, a detachable windshield gives you the freedom to define your ride at the drop of a hat. Ride across the country protected from the elements, then quickly remove the windshield to hit the streets in style. These one-piece windshields are formed from hard-coated polycarbonate material to resist scratching and the complete assembly features polished stainless brackets that mount to the Original Equipment rubber isolated docking points for ease of installation and removal. Windshields are available in a variety of heights to match your size and riding style.

Fits '94-later Road King® models. Will fit '04-later FLHRS models with the additional purchase of Mounting Hardware Kit P/N 58221-04.

**57995-96** 22" Clear. **\$334.95**  
Windshield dimensions: Overall height – 29.0"; width – 23.1".

**58325-06** 18" Clear. **\$334.95**  
Windshield dimensions: Overall height – 25.0"; width – 23.1".

**57767-00** 16" Clear. **\$309.95**  
Windshield dimensions: Overall height – 23.0"; width – 23.1".

**57981-97** 16" Light Smoke. **\$349.95**  
Windshield dimensions: Overall height – 23.0"; width – 23.1".

**Also available:**

### ROAD KING CUSTOM WINDSHIELD DOCKING HARDWARE KIT

Kit includes the hardware required to install a H-D® Detachables™ Road King Windshield on the Road King Custom model.

**58221-04** Fits '04-later FLHRS models. **\$29.95**

## D. REPLACEMENT WINDSHIELD SCREEN

Formed of polycarbonate and available in a size that suits your riding needs. Kit includes screen, cross brace tape and instructions.

Fits '94-later Road King models (except FLHRSE5/6 models).

**58433-96** 22" Clear. **\$159.95**

**58194-94** 22" Light Smoke. **\$169.95**

**58135-94** 20" Light Smoke. **\$159.95**

**57768-00** 16" Clear. **\$144.95**

**58195-94** 16" Light Smoke. **\$159.95**



**C. ROAD KING DETACHABLE WINDSHIELD – 16" LIGHT SMOKE**

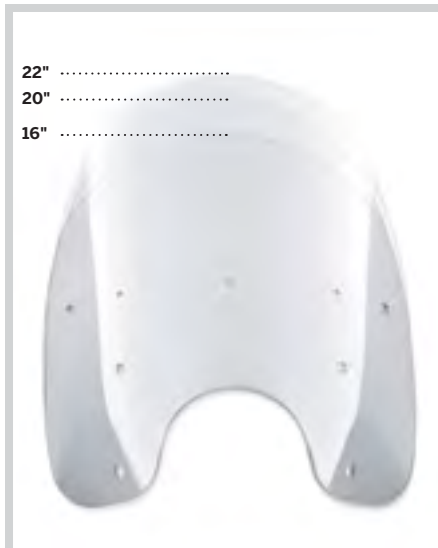

**D. REPLACEMENT WINDSHIELD SCREEN**

*Notice: The prices appearing in this catalog are the manufacturer's suggested retail prices. Actual retail prices may vary.*

## 338 TOURING & TRIKE

Windshields – Road King®

### A. ROAD KING® 14" H-D® DETACHABLES™ WIND DEFLECTOR

Maintain the same low-down mini-shield styling of the Road King® Dark Smoke Wind Deflector with a little extra wind protection. This 3.0" taller oversized dark smoke screen features polished stainless steel mounting brackets to provide the same ease of installation as the stock Road King windshield.

**57357-07** 14" Dark Smoke. **\$329.95**

Fits '94-later Road King models. Will fit FLHRS models with the additional purchase of Mounting Hardware Kit P/N 58221-04. Stock on '07 FLHRSE models. Windshield dimensions: Overall height – 21.0"; width – 21.4".



A. ROAD KING 14" H-D DETACHABLES WIND DEFLECTOR



B. ROAD KING 11" H-D DETACHABLES WIND DEFLECTOR

### B. ROAD KING 11" H-D DETACHABLES WIND DEFLECTOR

Keep the wind and glare out of your eyes with this Smoked Wind Deflector. This dark smoke detachable mini-shield follows the form of a traditional Harley-Davidson® Road King windshield, but its much smaller size adds a touch of low-down attitude.

**58163-02** 11" Dark Smoke. **\$309.95**

Fits '94-later Road King models. Will fit FLHRS models with the additional purchase of Mounting Hardware Kit P/N 58221-04. Stock on '08 FLHRSE2 models. Windshield dimensions: Overall height – 18.0"; width – 19.4".

### C. REPLACEMENT 14" WINDSHIELD

Customize the wind deflector height on your Custom Vehicle Operations™ Road King motorcycle to match your riding style, without compromising the low-down look. Kit includes 3.0" taller dark smoke windshield, cushion cross brace tape and installation instructions. Requires reuse of Wind Deflector windshield brackets.

**58799-02** 14" Dark Smoke. **\$144.95**

Fits '02 FLHRSE models or Road King models equipped with Smoked Wind Deflector P/N 58163-02. Stock on '02 FLHRSE models. Windshield dimensions: Overall height – 21.0"; width – 21.4".



C. REPLACEMENT 14" WINDSHIELD

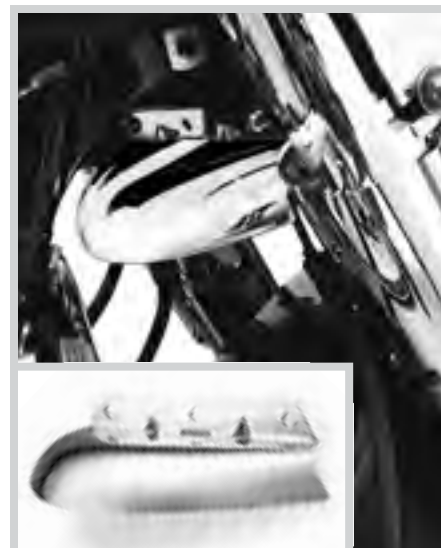

D. FRONT FORK AIR BAFFLE – CHROME

### D. FRONT FORK AIR BAFFLE – CHROME

Deflect the cold night wind rushing between the fork tubes of your Touring model. This stylish chrome air baffle replaces the Original Equipment black baffle on '00-earlier models. Includes chrome mounting hardware.

**58520-79TC** **\$27.95**

Fits '80-'13 FLT, FLHT, FLHX and FLHR models. Does not fit Trike models.

### E. FORK-MOUNT WIND DEFLECTORS – CHROME

Dress your bike for comfort and style. Wind Deflectors extend the windshield's coverage for superior protection in any weather. The scooped Deflectors are shaped to channel the air flow and direct the rush of air and turbulence around the rider. Deflectors attach to the fork brackets for a clean, integrated look and the chrome finish is the perfect complement to polished or chrome front end components. Easy-to-install kit includes all required mounting hardware.

**57400146A** **\$89.95**

Fits '95-later FLHR, FLHRC, FLHRS and '14-later FLHRSE models. Does not fit FLHT, FLHTC, FLHX and FLHXS models. Does not fit models equipped with Fairing Lowers. Does not fit '95-'13 models equipped with Lighted Fork Slider Kit or Custom Auxiliary Lighting Bracket Kit P/N 69227-04A or 68000043.



E. FORK-MOUNT WIND DEFLECTORS – CHROME

Notice: The prices appearing in this catalog are the manufacturer's suggested retail prices. Actual retail prices may vary.



NEW



F. H-D DETACHABLES 20" WINDSHIELD – FREEWHEELER MODELS

## TOURING & TRIKE 339

Windshields – Freewheeler™

### F. H-D® DETACHABLES™ WINDSHIELDS – FREEWHEELER™ MODELS

Designed to be installed or removed without tools in seconds, a detachable windshield gives you the freedom to define your ride at the drop of a hat. Ride across the country protected from the elements, then quickly remove the windshield to hit the streets in style. These one-piece windshields are formed from hard-coated polycarbonate material to resist scratching and the complete assembly features polished stainless brackets that mount to rubber isolated docking points for ease of installation and removal. Windshields are available in a variety of heights to match your size and riding style.

Fits '15-later FLRT models.

<b>57400273</b>	20" Clear.	<b>\$349.95</b>
<b>57400274</b>	16" Light Smoke.	<b>\$359.95</b>

NEW

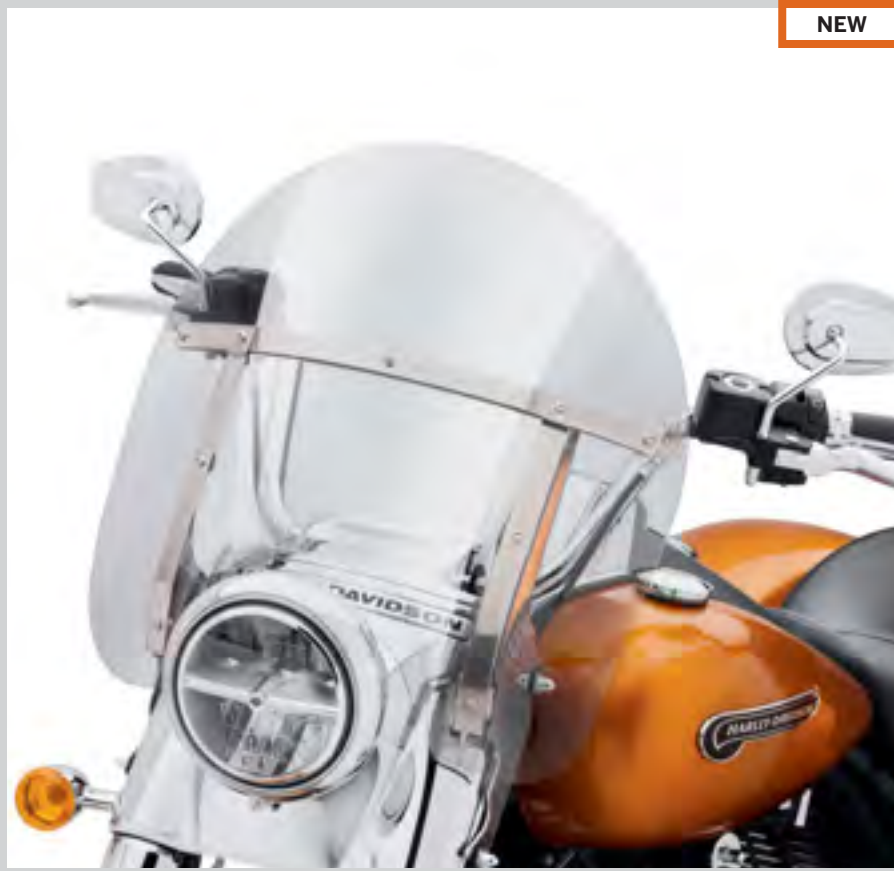

F. H-D DETACHABLES 16" WINDSHIELD – FREEWHEELER MODELS

TOURING

Notice: The prices appearing in this catalog are the manufacturer's suggested retail prices. Actual retail prices may vary.

# 340 TOURING & TRIKE

Windshields – Electra Glide®

## A. WIND SPLITTER WINDSHIELD – BATWING FAIRING

In the world of functional performance, size does matter. After all, it's simple to understand that the larger the windshield area, the greater the amount of wind deflection. The Wind Splitter Windshield is a great look for all Touring models and is shaped for the perfect combination of effective airflow management and "wow" styling. The sweeping design complements the shape of the fairing and the inner dash panel and adds height over a traditional low-profile wind deflector in the center where it counts. The shape decreases wind noise and improves your ability to hear the motorcycle's sound system. The rich smoked finish does not interfere with your forward view and looks great against any paint color. The easy-to-install Wind Splitter features a center-mount Bar & Shield medallion for a distinctive finishing touch.

Fits '14-later Electra Glide®, Street Glide® and Tri Glide® models.

**57400204** 4.5" Dark Smoke. **\$154.95**  
Does not fit with Windshield Bags or Pouches.

**57400205** 7" Dark Smoke. **\$159.95**  
Does not fit with Windshield Bags or Pouches.

**57400206** 10" Light Smoke. **\$164.95**

Fits '96-'13 Electra Glide®, Street Glide® and Trike models. Does not fit with zÜmo® 550 GPS Navigator, Windshield Bags or Pouches.

**57400091** 4.5" Dark Smoke. **\$159.95**

**57164-10** 7" Dark Smoke. **\$164.95**

**57400092** 10" Light Smoke. **\$169.95**



A. WIND SPLITTER WINDSHIELD – ELECTRA GLIDE  
(4.5" DARK SMOKE SHOWN)



A. WIND SPLITTER WINDSHIELD – ELECTRA GLIDE  
(7" DARK SMOKE SHOWN)



A. WIND SPLITTER WINDSHIELD – ELECTRA GLIDE  
(10" LIGHT SMOKE SHOWN)

Notice: The prices appearing in this catalog are the manufacturer's suggested retail prices. Actual retail prices may vary.



# TOURING & TRIKE 341

Windshields – Electra Glide®



**B. BATWING FAIRING WINDSHIELDS**



**B. BATWING FAIRING WINDSHIELD – 15"**



**B. BATWING FAIRING WINDSHIELD – 12"**



**B. BATWING FAIRING WINDSHIELD – 10"**



**C. SPORT WINDSHIELD – 10"**



**D. BATWING FAIRING WIND DEFLECTOR – MEDIUM PROFILE**



**E. BATWING FAIRING WIND DEFLECTOR – LOW PROFILE**



**F. BATWING FAIRING 4" BLACK WIND DEFLECTOR**

## B. BATWING FAIRING WINDSHIELDS

Tailor your bike to your size and riding style. For the best compromise between adequate protection from the elements and a clear view of the road ahead, select a windshield that tops out just below eye level. This reduces helmet buffeting while allowing a view unobstructed by dirt, bugs and rain drops. Harley-Davidson® windshields are formed of hard-coated polycarbonate for strength and scratch resistance and are available in a variety of heights and tints to suit your riding needs.

Fits '14-later Electra Glide®, Street Glide® and Tri Glide® models.

<b>57400224</b>	15" Clear.	<b>\$134.95</b>
<b>57400228</b>	12" Clear.	<b>\$134.95</b>
<b>57400226</b>	12" Light Smoke.	<b>\$134.95</b>
<b>57400227</b>	10" Clear.	<b>\$134.95</b>
<b>57400225</b>	10" Light Smoke.	<b>\$135.95</b>

Fits '96-'13 Electra Glide, Street Glide and Trike models.

<b>58314-97</b>	15" Clear.	<b>\$139.95</b>
<b>58187-96</b>	12" Clear.	<b>\$139.95</b>
<b>58302-96</b>	12" Light Smoke.	<b>\$139.95</b>
<b>58301-96</b>	10" Clear.	<b>\$139.95</b>
<b>58303-96</b>	10" Light Smoke.	<b>\$139.95</b>

Fits '86-'95 FLHT models. (not shown)

<b>58187-86</b>	12" Clear.	<b>\$149.95</b>
-----------------	------------	-----------------

Fits '83-'85 FLHT models. (not shown)

<b>58181-78</b>	18.5" Clear.	<b>\$149.95</b>
-----------------	--------------	-----------------

## C. SPORT WINDSHIELD

Combine the mini-shield styling of a wind deflector with a little extra wind protection. This 10.0" Sport Shield features a traditional wind screen shape, but adds a forward "flip" to the trailing edge to deflect the air flow over the rider. You get a shield that's still easy to look over, but without the turbulence usually associated with a short wind deflector. The light-smoke shield is formed from hard-coated polycarbonate for strength and scratch resistance.

<b>57400213</b>	10" Light Smoke.	<b>\$159.95</b>
-----------------	------------------	-----------------

Fits '14-later Electra Glide, Street Glide and Tri Glide models.

## D. BATWING FAIRING WIND DEFLECTOR – MEDIUM PROFILE

Style meets function. This 7.0" tall Wind Deflector splits the difference between the wind deflector and a low windshield, offering sport styling with a little greater wind protection. Harley-Davidson windshields are formed of hard-coated polycarbonate for strength and scratch resistance and the dark smoke tint complements any paint color.

<b>57400229</b>	7" Dark Smoke.	<b>\$134.95</b>
-----------------	----------------	-----------------

Fits '14-later Electra Glide, Street Glide and Tri Glide models.

<b>57185-05</b>	7" Dark Smoke.	<b>\$129.95</b>
-----------------	----------------	-----------------

Fits '96-'13 Electra Glide, Street Glide and Trike models.

Stock on '05 FLHTCSE models.

## E. BATWING FAIRING WIND DEFLECTOR – LOW PROFILE

Maintain your forward view with this low-profile wind deflector. The shield adds a radical shape to the traditional Batwing fairing and the dark smoke tint complements any paint color. Harley-Davidson windshields are formed of hard-coated polycarbonate for strength and scratch resistance.

<b>57400243</b>	5" Dark Smoke.	<b>\$134.95</b>
-----------------	----------------	-----------------

Fits '14-later Electra Glide, Street Glide and Tri Glide models.

Stock on '14 FLHX models.

<b>58207-04</b>	4" Dark Smoke.	<b>\$129.95</b>
-----------------	----------------	-----------------

Fits '96-'13 Electra Glide, Street Glide and Trike models.

Stock on '04 FLHTCSE models.

## F. BATWING FAIRING 4" BLACK WIND DEFLECTOR

Opaque black 4.0" tall deflector provides radical styling for the ultimate custom cruiser.

<b>58204-98</b>	4" Dark Smoke.	<b>\$129.95</b>
-----------------	----------------	-----------------

Fits '96-'13 Electra Glide, Street Glide and Trike models.

TOURING

Notice: The prices appearing in this catalog are the manufacturer's suggested retail prices. Actual retail prices may vary.

# 342 TOURING & TRIKE

Windshields – Electra Glide®

## A. CHROME WINDSHIELD TRIM – GROOVED

Custom polished and chrome-plated billet windshield trim accents the outer fairing and dresses your bike in style. The grooved design grabs your eye and adds character to the base of the windshield. Easy to install, the kit includes stainless steel mounting hardware.

**61400224** **\$149.95**

Fits '14-later Electra Glide®, Street Glide® and Tri Glide® models.



A. CHROME WINDSHIELD TRIM – GROOVED

## B. EDGE CUT WINDSHIELD TRIM

Live your life on the edge. Custom windshield trim features a crisp anodized finish that is machined to expose the highlights of raw aluminum. The contrasting cut back look makes a powerful visual statement and works great with both traditional and contemporary customizing styles. Easy to install, the kit includes stainless steel mounting hardware.

**61300358** **\$169.95**

Fits '14-later Electra Glide, Street Glide and Tri Glide models.

## C. BAR & SHIELD WINDSHIELD TRIM

This highly polished stainless steel windshield trim is accented by four slots that allow the color of the outer fairing to show through. This unique trim piece is highlighted with Bar & Shield logo machined into the surface. Kit includes stainless steel mounting hardware.

**61300275** **\$99.95**

Fits '14-later Electra Glide, Street Glide and Tri Glide models.

**59133-99** **\$84.95**

Fits '96-'13 Electra Glide, Street Glide and Trike models.



B. EDGE CUT WINDSHIELD TRIM

## D. CHROME WINDSHIELD MOLDING

Chrome Windshield Molding accents the outer fairing on Electra Glide models. Easily installed, including all necessary hardware and instructions.

**61300310** **\$49.95**

Fits '14-later Electra Glide, Street Glide and Tri Glide models.

**59123-96** **\$44.95**

Fits '96-'13 Electra Glide, Street Glide and Trike models.



C. BAR & SHIELD WINDSHIELD TRIM



D. CHROME WINDSHIELD MOLDING

*Notice: The prices appearing in this catalog are the manufacturer's suggested retail prices. Actual retail prices may vary.*





**E. ADJUSTABLE AIR DEFLECTORS**



# TOURING & TRIKE 343

Windshields – Electra Glide®

## E. ADJUSTABLE AIR DEFLECTORS

The Adjustable Air Deflectors feature an infinitely adjustable friction pivot that holds the wing in position to direct the air where you need it. Close the vent to direct airflow around the fairing or open the vent to maximize airflow on hot days. Available in dark or light smoke finish, the translucent deflectors are easy to install with the included mounting hardware.

Fits '14-later Street Glide® models. Original Equipment on Electra Glide® and Tri Glide® models.

**57000529** Dark Smoke. **\$119.95**

Fits '08-'13 Electra Glide, Street Glide and Trike models.

**58156-08A** Dark Smoke. **\$119.95**

**58166-08A** Light Smoke. **\$119.95**

## F. ADJUSTABLE AIR DEFLECTOR KIT

Help keep your cool on hot summer rides. The smoked Adjustable Air Deflectors feature a spring-loaded detent system that locks in four different positions. Close the vent to direct airflow around the fairing or open the vent to maximize airflow on hot days. Easy to install, the complete kit includes left and right deflector and all necessary mounting hardware.

**57804-07** Light Smoke. **\$119.95**

Fits '96-'13 Electra Glide, Street Glide and Trike models.



**F. ADJUSTABLE AIR DEFLECTOR KIT**



## G. FAIRING AIR DEFLECTORS

Designed to deflect air away from the rider's elbows and upper torso, these easy-to-install Air Deflectors reduce the draft behind the fairing. Fixed-position deflectors are available in your choice of black or smoked finish to match your styling direction.

Fits '96-'13 Electra Glide, Street Glide and Trike models.

**58568-98A** Black. **\$39.95**

**57740-05** Dark Smoke. **\$49.95**

**58120-96A** Light Smoke. **\$49.95**



**G. FAIRING AIR DEFLECTORS**



*Notice: The prices appearing in this catalog are the manufacturer's suggested retail prices. Actual retail prices may vary.*

# 344 TOURING & TRIKE

Windshields – Road Glide®

## A. WIND SPLITTER WINDSHIELD – ROAD GLIDE®

In the world of functional performance, size does matter. After all, it's simple to understand that the larger the windshield area, the greater the amount of wind deflection. The Wind Splitter Windshield is a great look for all Touring models and is shaped for the perfect combination of effective air flow management and "wow" styling. The sweeping design complements the shape of the fairing and the inner dash panel and adds height over a traditional low-profile wind deflector in the center where it counts. The shape decreases wind noise and improves your ability to hear the motorcycle's sound system. The rich smoked finish does not interfere with your forward view and looks great against any paint color. The easy-to-install Wind Splitter features a center-mount Bar & Shield medallion for a distinctive finishing touch.

Fits '15-later Road Glide® models.

<b>57400271</b>	12" Light Smoke.	<b>\$194.95</b>
<b>57400270</b>	15" Light Smoke.	<b>\$209.95</b>

Fits '98-'13 Road Glide models.

<b>57400093</b>	9" Dark Smoke.	<b>\$159.95</b>
<b>57166-10A</b>	12" Dark Smoke.	<b>\$164.95</b>
<b>57400094</b>	15" Light Smoke.	<b>\$169.95</b>



NEW



NEW

A. 12" WIND SPLITTER WINDSHIELD – (57400271 SHOWN)



NEW



NEW

A. 15" WIND SPLITTER WINDSHIELD – (57400270 SHOWN)



A. 9" WIND SPLITTER WINDSHIELD – ROAD GLIDE  
(57400093 SHOWN)



A. 12" WIND SPLITTER WINDSHIELD –  
(57166-10A SHOWN)



A. 15" WIND SPLITTER WINDSHIELD –  
(57400094 SHOWN)

Notice: The prices appearing in this catalog are the manufacturer's suggested retail prices. Actual retail prices may vary.



# TOURING & TRIKE 345

Windshields – Road Glide®

NEW



**B. ROAD GLIDE 19" WINDSHIELD**

NEW



**B. ROAD GLIDE 15.5" WINDSHIELD**

## B. ROAD GLIDE® WINDSHIELDS

Tailor your bike to your size and riding style. For the best compromise between adequate protection from the elements and a clear view of the road ahead, select a windshield that tops out just below eye level. This reduces helmet buffeting while allowing a view unobstructed by dirt, bugs and rain drops. Harley-Davidson® windshields are formed of hard-coated polycarbonate for strength and scratch resistance and are available in a variety of heights to suit your riding needs.

Fits '15-later Road Glide® models.

**57400279** 19" Clear. **\$169.95**

**57400281** 15.5" Clear. **\$159.95**

## C. ROAD GLIDE 19" WINDSHIELD – CLEAR

The tall windshield is approximately 3" taller than stock and is hard-coated for durability.

**58283-04B** Fits '04-'13 Road Glide models. **\$174.95**

## D. ROAD GLIDE 10" WINDSHIELD – LIGHT SMOKE

This low-profile windshield option is approximately 6" shorter than stock with a light smoke tinted look. The windshield is hard-coated for durability.

**58284-04B** Fits '04-'13 Road Glide models. **\$159.95**

## E. ROAD GLIDE 7" CONTOURED WIND DEFLECTOR – LIGHT SMOKE

Go low with this light smoke Road Glide® model windshield that is contoured for a unique style. Stock on FLTRSEI2 models.

**58753-01B** Fits '04-'13 Road Glide models. **\$144.95**



**C. ROAD GLIDE 19" WINDSHIELD – CLEAR (SHOWN WITH ROAD GLIDE WINDSHIELD TRIM)**



**D. ROAD GLIDE 10" WINDSHIELD – LIGHT SMOKE (SHOWN WITH ROAD GLIDE WINDSHIELD TRIM)**



**E. ROAD GLIDE 7" CONTOURED WIND DEFLECTOR – LIGHT SMOKE**

*Notice: The prices appearing in this catalog are the manufacturer's suggested retail prices. Actual retail prices may vary.*

# 346 TOURING & TRIKE

Windshields – Road Glide®

## A. ROAD GLIDE® CONTOURED WIND DEFLECTOR – BLACK

Go low with this Road Glide® model windshield that is contoured for a unique style.

**57400280** 6" Black. **\$139.95**

Fits '15-later Road Glide models. Original Equipment on '15-later FLTRX and FLTRXS models.

**57988-09** **\$149.95**

Fits '98-'13 Road Glide models. Will not fit with Road Glide Windshield Trim P/N 58519-07.

## B. ROAD GLIDE 5" WIND DEFLECTOR – BLACK

Opaque black deflector provides radical styling for the ultimate custom cruiser.

**57957-98A** **\$119.95**

Fits '98-'13 Road Glide models. Will fit with Road Glide Windshield Trim P/N 58519-07.

## C. ROAD GLIDE WIND DEFLECTOR KIT

Easy to install, these snap-fit Wind Deflectors reduce and redirect the airflow that rises between the fairing and fork tubes. The resulting reduction in updraft can dramatically reduce buffeting for many riders.

**57000510** **\$39.95**

Fits '15-later Road Glide models. Stock on '15 FLTRUSE.

**57000063** **\$39.95**

Fits '98-'13 Road Glide models. (Will not fit models equipped with the Fuel Tank retrofit mounting kit.) Stock on '11-'13 CVO™ Road Glide.

NEW



A. ROAD GLIDE CONTOURED WIND DEFLECTOR – BLACK  
(57400280 SHOWN)



A. ROAD GLIDE 6" CONTOURED WIND DEFLECTOR – BLACK  
(57988-09 SHOWN)



B. ROAD GLIDE 5" WIND DEFLECTOR – BLACK



C. ROAD GLIDE WIND DEFLECTOR KIT



C. WIND DEFLECTOR –  
(57000510 SHOWN)



C. WIND DEFLECTOR –  
(57000063 SHOWN)

Notice: The prices appearing in this catalog are the manufacturer's suggested retail prices. Actual retail prices may vary.



NEW

# TOURING & TRIKE 347

Windshields – Road Glide®

## D. ROAD GLIDE® SPLIT WINDSHIELD TRIM

Stock on the 2015 CVO™ Road Glide®, this easy to install, 2 piece trim kit adds a speedy looking splash of chrome to the base of the windshield.

**57400299** Chrome. **\$119.95**  
Fits '15-later Road Glide models. Stock on '15 FLTRUSE models.

## E. ROAD GLIDE WINDSHIELD TRIM

The fairing is a key visual element of your bike, so it demands the bold design of this elegant contoured windshield trim. This sweeping trim hugs the curvature of the fairing and conceals the base of the windshield and the windshield gasket for a clean, finished look. The multi-piece design simplifies installation. Kit includes mounting hardware and "Road Glide" medallion.

Fits '04-'13 Road Glide models (except FLTRXSE and FLTRUSE).

**58519-07A** Chrome. **\$149.95**  
**57400150** Gloss Black. **\$149.95**



D. ROAD GLIDE SPLIT WINDSHIELD TRIM



E. ROAD GLIDE WINDSHIELD TRIM – CHROME  
(SHOWN WITH CONTOURED WIND DEFLECTOR)



E. ROAD GLIDE WINDSHIELD TRIM – GLOSS BLACK  
(SHOWN WITH WIND SPLITTER WINDSHIELD)

TOURING

Notice: The prices appearing in this catalog are the manufacturer's suggested retail prices. Actual retail prices may vary.

# 348 TOURING & TRIKE

## Fairing Accessories

### A. THREE-POCKET FAIRING POUCH

Convenient storage space at your fingertips. Designed to complement H-D® wind deflectors and windshields, this fairing pouch is ideal for storing mobile devices, sunglasses and other small items. The sturdy plastic pouches are wrapped in supple UV-resistant vinyl for a premium look and feel and the magnetic closures keep your items within reach without detracting from the tastefully smooth styling.

**93300054A** **\$129.95**

Fits '14-later Electra Glide®, Street Glide® and Tri Glide® models with windshields. Not for use with Wind Splitter Windshields P/N 57400204 or 57400205, H-D® Detachables™ Two-Up Tour-Pak Mounting Rack or any H-D Detachables Two-Up Luggage Rack.



A. THREE-POCKET FAIRING POUCH – '14-LATER MODELS

### B. THREE-POCKET FAIRING POUCH

Convenient storage space at your fingertips. Designed to complement H-D wind deflectors and windshields, this fairing pouch is ideal for storing cell phones, sunglasses and other small items. The sturdy plastic pouches are wrapped in supple UV-resistant vinyl for a premium look and feel and the magnetic closures keep your items within reach, while not detracting from the tastefully smooth styling. The left-hand pouch can be easily removed to accommodate your fairing-mounted GPS unit. Attractive Harley-Davidson script is featured on the front center pouch and on the outboard – facing side, visible through the windshield.

**58900-11** **\$114.95**

Fits '96-'13 Electra-Glide, Street Glide and Trike models. Not for use with Fairing Dash Pads. Models equipped with Illuminated Windshield Molding P/N 57335-08 requires separate purchase of Screws P/N 4456 (qty 3), Bar & Shield Windshield Molding P/N 59133-99 requires separate purchase of Screws P/N 94386-92T (qty 3), Chrome Windshield Molding P/N 59213-96 requires separate purchase of Screws P/N 94397-91T (qty 3).



B. THREE-POCKET FAIRING POUCH – '96-'13 MODELS

### C. ELECTRA GLIDE LEATHER FAIRING POUCH

Easily installed inner fairing pouch is designed to hold sunglasses, cell phones or riding gloves. All-leather construction around a molded ABS plastic base for shape retention. Has an easy-to-use full-length hook-and-loop closure and features a black embroidered Bar & Shield logo on the lid.

**58248-96** **\$109.95**

Fits '96-'13 Electra Glide and Tri Glide models. Does not fit with Original Equipment or accessory Wind Deflectors. Does not fit with Fairing Mounted GPS Navigation Systems.



B. THREE-POCKET FAIRING POUCH – '96-'13 MODELS (SHOWN WITH GPS UNIT)



C. ELECTRA GLIDE LEATHER FAIRING POUCH

*Notice: The prices appearing in this catalog are the manufacturer's suggested retail prices. Actual retail prices may vary.*



# TOURING & TRIKE 349

Wind Deflectors



**D. ELECTRA GLO FAIRING EDGE LIGHT KIT**

## D. ELECTRA GLO™ FAIRING EDGE LIGHT KIT

Amplify your ride. The Electra Glo™ Fairing Edge Light Kit adds forward-facing white LED accent lights to the front profile of your bike. Formed to follow the contour of the batwing fairing, the slim strip of lamps adds a strong visual element to the iconic shape of the Electra Glide® model. The electrifying appearance adds conspicuity to get you noticed and the smoked housing conceals the lights and blends into the background when switched off. Simple "plug in" connections with no cutting or splicing of wires required.

**68000104** **\$99.95**

Fits '14-later Electra Glide, Street Glide® and Tri Glide® models.

**68000035** **\$99.95**

Fits '96-'13 Electra Glide, Street Glide and Trike models.

## E. MID-FRAME AIR DEFLECTOR

Designed for severe duty and extreme temperature applications. These black deflectors attach to the frame below the seat and direct heat away from the rider to improve comfort.

**58002-09** **\$79.95**

Fits '09-later Touring and Trike models. Original Equipment on FLHTCU, FLHTCUTG, FLTRU and FLHTK models.

**58022-07A** **\$79.95**

Fits '01-'08 Touring models. Does not fit '01-'07 models equipped with Adjustable Rider Backrests.

## F. MID-FRAME AIR DEFLECTOR TRIM

This injection-molded trim adds a touch of chrome to the Mid-Frame Air Deflectors on touring vehicles. These chrome accents blend the look of chrome from the engine and help make the deflectors look integrated with the bike.

**61400028** **\$59.95**

Fits '09-later Touring and Trike models equipped with Mid-Frame Air Deflectors.

## G. SOFT LOWERS

Extend your riding season. Full coverage Soft Lower provide wind and mud protection for the rider's legs and boots and minimize cold updrafts as the weather changes. Covers are custom shaped to hug the engine guard to minimize flapping and they simply clip in place for speedy installation as the weather changes. Two-way zippered outer edge accommodates guard-mounted highway pegs in almost any position. Reflective piping provides added visibility and convenient zippered pockets provide additional storage for maps or other small items.

**57100210** **\$89.95**

Fits '80-later Touring and Trike models equipped with engine guards. Does not fit Mustache Engine Guards. Does not fit models with Extended Reach Brake Lever or Extended Reach Shift Lever.



**E. MID-FRAME AIR DEFLECTOR**



**F. MID-FRAME AIR DEFLECTOR TRIM**



**G. SOFT LOWERS – FRONT VIEW**



**G. SOFT LOWERS – REAR VIEW**

Notice: The prices appearing in this catalog are the manufacturer's suggested retail prices. Actual retail prices may vary.

# 350 TOURING & TRIKE

Fairing Lower



## ROAD KING SHOWN WITH COLOR-MATCHED VENTED FAIRING LOWERS

### A. Color-Matched Vented Fairing Lower

Color	'83-'13		'14-later	
	P/N	Price	P/N	Price
Unpainted	58854-05	\$499.95	57100258	\$449.95
Amber Whiskey	—	—	57100257DST	\$699.95
Anniversary Vintage Black	58854-13DME	\$674.95	—	—
Big Blue Pearl	58854-12DJO	\$674.95	57100257DJO	\$699.95
Birch White	58854-05AV	\$674.95	—	—
Black Cherry	58854-05BPS	\$674.95	—	—
Black Denim	58854-09BYM	\$674.95	57100257BYM	\$699.95
Black Magic	—	—	57100257DWV	\$699.95
Black Pearl	58854-05BPY	\$674.95	—	—
Blackened Cayenne	—	—	57100257DSZ	\$699.95
Brilliant Silver	58854-05BHT	\$674.95	57100257BHT	\$699.95
Burnt Emerald	58854-13DRC	\$849.95	—	—
Candy Orange	58854-13DPU	\$674.95	—	—
Charcoal Pearl	—	—	57100257DTF	\$699.95
Charcoal Satin	—	—	57100257DUM	\$699.95
Chrome Yellow	58854-12DGV	\$674.95	—	—
Chrome Yellow Pearl	58854-13DPR	\$674.95	—	—
Cool Blue Pearl	58854-11DGR	\$674.95	—	—
Copper Pearl	58854-08CPH	\$674.95	—	—
Crimson Red Sunglo	58854-08COZ	\$674.95	—	—
Daytona Blue	—	—	57100257DUA	\$699.95
Deep Cobalt	58854-06BXT	\$674.95	—	—
Deep Jade Pearl	—	—	57100257DWF	\$699.95
Deep Purple	58854-12DKM	\$674.95	—	—

Color	'83-'13		'14-later	
	P/N	Price	P/N	Price
Ember Red Sunglo	58854-12DJS	\$674.95	—	—
Flame Blue Pearl	58854-09CWA	\$674.95	—	—
Galaxy Grey	58854-13CPB	\$849.95	—	—
Merlot Sunglo	58854-10DCE	\$674.95	—	—
Midnight Pearl	58854-12DKJ	\$674.95	—	—
Morocco Gold	—	—	57100257DTC	\$699.95
Mysterious Red Sunglo	—	—	57100257DSW	\$699.95
Obsidian	58854-13DRJ	\$849.95	—	—
Pewter Pearl	58854-07CGR	\$674.95	—	—
Radioactive Green	—	—	57100257DWJ	\$699.95
Red Hot Sunglo	58854-09CYS	\$674.95	—	—
Sand Camo Denim	—	—	57100257DSR	\$699.95
Sand Pearl	—	—	57100257DUN	\$699.95
Scarlet Red	58854-10DBJ	\$674.95	—	—
Sedona Orange	58854-11DGX	\$674.95	—	—
Spiced Rum	58854-10DEK	\$849.95	—	—
Starfire Black	58854-12DLO	\$849.95	—	—
Superior Blue	—	—	57100257DWC	\$699.95
Tequila Sunrise ('10 FLHXSE)	58854-10DEM	\$849.95	—	—
Tequila Sunrise	58854-12DKO	\$674.95	—	—
Vivid Black	58854-05DH	\$674.95	57100257DH	\$699.95
White Gold Pearl	58854-07CGS	\$674.95	—	—
White Hot Denim	58854-11DHA	\$674.95	—	—
White Hot Pearl	58854-13DJI	\$674.95	—	—

Notice: The prices appearing in this catalog are the manufacturer's suggested retail prices. Actual retail prices may vary.



# TOURING & TRIKE 351

Fairing Lower

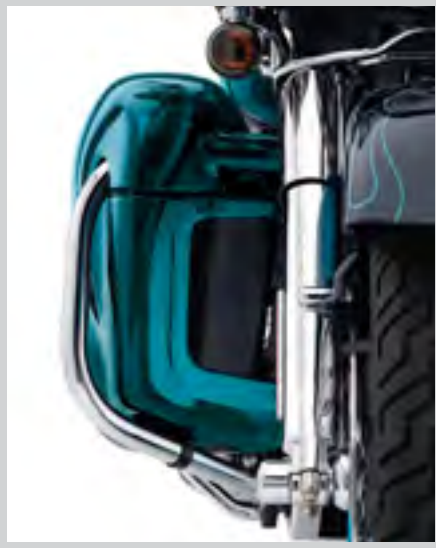

A. VENTED FAIRING LOWER – OPEN



A. VENTED FAIRING LOWER – CLOSED



A. COLOR-MATCHED VENTED FAIRING LOWER KIT – '14-LATER MODELS



A. COLOR-MATCHED VENTED FAIRING LOWER KIT – '83-'13 MODELS



B. COLOR-MATCHED ROAD GLIDE NON-VENTED FAIRING LOWER KIT



C. NON-VENTED FAIRING LOWER

## A. COLOR-MATCHED VENTED FAIRING LOWER KIT\*

Control the airflow to your lower legs for maximum riding comfort. Original Equipment on many Touring models, these Color-Matched Fairing Lower feature a venting system that allows you to adjust the amount of air that circulates across the engine. On hot days, open the vent to direct additional cooling air and on cold or rainy days, close the vents for maximum protection from the elements. The ratcheting friction lock pivot allows you to easily set the position. The complete kit includes left and right Fairing Lower, convenient glove box and lid and all necessary mounting hardware. Glove Box Doors are sold separately. NOTE: Fairing Lower Kits are painted in a single color and do not feature pinstriping.

Fits '14-later air-cooled Touring and Trike models. Does not fit Twin-Cooled™ models. Freewheeler™ models require separate purchase of Engine Guard P/N 49184-09A or 49050-09A and Steering Stabilizer Bracket P/N 83865-09. Does not fit with Mustache Engine Guards.

<b>57100258</b>	Unpainted.	<b>\$449.95</b>
<b>See Matrix</b>	Color-Matched.	—

Fits '83-'13 Touring (except '98-'09 FLTR) and Trike models. Stock on FLHTCU, FLHTK and FLHTCUTG. Models without Engine Guard will require the installation of Engine Guard P/N 49066-09 or 49050-09, Screw P/N 4924 (2), Washer P/N 2708A (1). Will not fit with Mustache Engine Guards. FLHXXX models also require the installation of Steering Stabilizer Bracket P/N 83865-09. Does not fit with Front Fender Adapter Kit 59013-02A or standard-size Heavy Breather Air Cleaner. Models equipped with Heavy Breather Air Cleaner require separate purchase of Compact Heavy Breather Kit P/N 28716-10.

<b>58854-05</b>	Unpainted.	<b>\$499.95</b>
<b>See Matrix</b>	Color-Matched.	—

## B. ROAD GLIDE® NON-VENTED FAIRING LOWER KIT\*

The unique lines of the Road Glide® models are accentuated with these fairing lowers. Available with Color-Matched factory paint or in primed finish, ready to apply your own custom design. Glove Boxes are sold separately. NOTE: All fairing lower kits are painted with a single color scheme and do not include pinstripes. FLTR and FLTRI models equipped with Stainless Steel Braided Clutch Cable P/N 38660-00A require separate purchase of Service Kit P/N 38674-01.

Fits '04-'09 FLTR/I models. (Does not fit with Front Fender Adapter Kit 59013-02A.)

<b>58861-04BDK</b>	Unpainted.	<b>\$599.95</b>
<b>58861-04DH</b>	Vivid Black.	<b>\$824.95</b>

## C. NON-VENTED FAIRING LOWER\*

Made from tough, lightweight vacuum-formed ABS, these fairing lowers protect the rider from the elements and direct cooling air to the engine. Lower attach to the engine guard without interfering with rider footboards. Kit includes all necessary mounting hardware. Glove Boxes are sold separately. NOTE: All fairing lower kits are painted with a single color scheme and do not include pinstripes.

Fits '83-'13 FLHT, FLHTC, FLHX and FLHR models. Does not fit with Front Fender Adapter Kit 59013-02A, Mustache Engine Guard P/N 49155-05, 49155-09A or 49442-10, Front Bullet Turn Signal Kit P/N 69492-05 and 69493-05. (NOTE: Requires drilling a hole in the left side fairing lower for the engine guard filler valve on '84-'87 models.)

<b>58830-88DH</b>	Vivid Black.	<b>\$674.95</b>
-------------------	--------------	-----------------

\*NOTE: This product is a "Paint to Order" accessory. Please allow for an average of 5 weeks delivery for this item.

Notice: The prices appearing in this catalog are the manufacturer's suggested retail prices. Actual retail prices may vary.

# 352 TOURING & TRIKE

## Fairing Lower

### A. FAIRING LOWER FITTED GLOVE BOX LINER KIT

Protect your belongings and reduce noise and rattles on the road. Soft-touch felt finish liner is formed to the fairing glove box interior for a perfect fit. Molded base and sides maximize the interior room and one-piece design allows easy removal for cleaning and maintenance.

**57100270** **\$39.95**

Fits '14-later Touring and Trike models equipped with Original Equipment or accessory Vented Fairing Lower. Does not fit Twin-Cooled™ models.

**58714-06** **\$29.95**

Fits '05-'13 Touring and Trike models equipped with Vented Fairing Lower.



A. FAIRING LOWER FITTED GLOVE BOX LINER KIT



### B. ROAD GLIDE® COMPARTMENT LINERS

Protect your belongings and reduce noise and rattles on the road. Soft-touch felt finish liner is formed to the fairing glove box interior for a perfect fit. Molded base and sides maximize the interior room and one-piece design allows easy removal for cleaning and maintenance.

**76000539** **\$39.95**

Fits '15-later Road Glide® models. Right liner includes integrated mobile device storage net.

**58932-98** **\$29.95**

Fits '98-'13 Road Glide models.



NEW

B. ROAD GLIDE COMPARTMENT LINERS  
(76000539 SHOWN)



B. ROAD GLIDE COMPARTMENT LINERS  
(58932-98 SHOWN)

### C. FAIRING LOWER QUICK-RELEASE HARDWARE KIT

Beat the summer heat and prepare for around-town cruising by removing the fairing lowers on your Ultra Classic® Electra Glide® model. This kit includes highly polished stainless steel clamps that are detachable without the need for tools.

**47200240** **\$129.95**

Fits '14-later FLHTCU and FLHTCUL models. Also fits '14-later Touring models equipped with Accessory Fairing Lower. Does not fit Twin-Cooled models or models equipped with fairing lower speakers.

**58146-07** **\$99.95**

Fits '05-'13 Touring and Trike models equipped with Vented Fairing Lower and '88-later Touring and Trike models equipped with Vented Fairing Lower Kit 58854-YYXX. Does not fit models equipped with fairing lower speakers.



C. FAIRING LOWER QUICK-RELEASE  
HARDWARE KIT –  
'14-LATER MODELS



C. FAIRING LOWER QUICK-RELEASE  
HARDWARE KIT –  
'05-'13 MODELS

### D. FAIRING LOWER SOFT STORAGE BAG

Protect your fairing lowers when they are removed for hot weather riding. This convenient storage bag features a heavy-weight 10-oz. cotton exterior and sturdy carrying handle. Dual zippers open to expose a soft felt interior with a sturdy divider for left and right lowers and two zippered pouches for loose hardware storage. A classic embroidered Bar & Shield logo adorns the bag's exterior.

**95983-07** **\$79.95**

Fits all styles of Harley-Davidson® Fairing Lower (except Twin-Cooled models).



C. FAIRING LOWER QUICK-RELEASE  
HARDWARE KIT



D. FAIRING LOWER SOFT STORAGE BAG

Notice: The prices appearing in this catalog are the manufacturer's suggested retail prices. Actual retail prices may vary.



# TOURING & TRIKE 353

## Fairing Lower



**E. FAIRING LOWER QUICK FLAP MAGNETIC DOORS**



**E. FAIRING LOWER QUICK FLAP MAGNETIC DOORS**

The Quick Flap Door Kit enables quick and easy access to fairing lower glove boxes. The flexible covers feature high-strength magnetic catches that replace the Original Equipment snap closures for one-handed access. Kit includes left and right side doors and magnetic catches. Combine with available Glove Box Liners for rattle-free storage.

**57100198** **\$54.95**

Fits '83-'13 Road King®, Electra Glide®, Street Glide® and Trike models equipped with vented and non-vented Fairing Lower Glove Boxes and '10-'13 Road Glide® models equipped with vented Fairing Lower Glove Boxes.

**F. FAIRING LOWER LOCKING GLOVE BOX DOORS**

Keyed-to-match security. Add secured storage to your fairing lowers. This Locking Glove Box Door Kit replaces the Original Equipment flexible snap-on covers and provides convenient, weather-resistant storage for documents, cell phones and sunglasses. The kits are "keyed to match" to your motorcycle ignition, for barrel style keys, for "one key" convenience. This locking door kit is an ideal companion to the Fitted Glove Box Liner Kit P/N 58714-06. Kit includes left and right locking door assemblies and door frames.

**57411-08** **\$195.95**

Fits '91-'13 Touring and Trike models equipped with Electra Glide Ultra style fairing lowers. Also fits accessory fairing lowers, vented and non-vented. Does not fit with Glove Box Door Pouches P/N 57400-06.



**F. FAIRING LOWER LOCKING GLOVE BOX DOORS**



**G. FAIRING LOWER GLOVE BOX DOOR POUCHES**

Pouches fit perfectly on your glove box doors to provide convenient storage of small items at your fingertips. Made of a ballistic nylon exterior and a soft, fuzzy interior with elastic sides for expandability. Perfect for your cell phone, digital media player, tollway pass or any other small items. Reinforced cover features an embroidered Bar & Shield logo. Kit includes left and right pouches.

**57400-06** **\$34.95**

Fits '91-'13 Touring and Trike models equipped with vented fairing lowers. Does not fit with Locking Glove Box Door P/N 57411-08.

**H. FLT AND FLHT FAIRING LOWER GLOVE BOXES**

Offers a convenient place to store riding gloves, sunglasses, etc. The snap-on door cover (included) is embossed with Bar & Shield logo. Available in black only.

**Ultra Classic® Styling**

**58683-89B** Left Side. **\$169.95**

Fits '04-earlier Original Equipment non-vented style FLHT Ultra Classic® Fairing Lower.

**58684-89B** Right Side. **\$169.95**

Fits '04-earlier Original Equipment non-vented style FLHT Ultra Classic Fairing Lower.

**58687-89** Left Side. **\$169.95**

Fits '98-'09 non-vented style FLT and FLTR Fairing Lower.

**58688-89A** Right Side. **\$169.95**

Fits '98-'09 non-vented style FLT and FLTR Fairing Lower.



**G. FAIRING LOWER GLOVE BOX DOOR POUCHES**



**H. FLT AND FLHT FAIRING LOWER GLOVE BOXES**



*Notice: The prices appearing in this catalog are the manufacturer's suggested retail prices. Actual retail prices may vary.*

## SEAT OF POWER

The right seat is equal parts ergonomics and comfort. Its shape anchors your position and determines the reach to the ground and to the controls and the padding supports your tailbone and hips to relieve stress and pressure. Pick the right one for you – and your passenger.



TALLBOY® SEAT



SUPER REDUCED REACH® SEAT

## LAP OF LUXURY

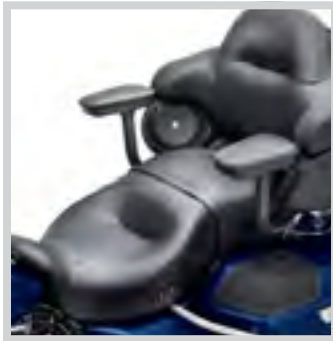

If your passenger is happy, you'll be happy. Premium passenger armrests have been ergonomically designed to provide the ultimate in passenger comfort. The soft pads provide excellent forearm support on a long ride, and eliminate the passenger's "what do I do with my hands" dilemma.

## CHANGING YOUR SEAT



Switching out your seat is simple. And because certain rides call for certain styles, some folks like to have multiple seats to match the occasion. Install a comfortable, supportive touring seat for the longer treks and swap it out for a low-profile seat for a night on the town. Please see your owner's manual for proper removal and installation of seats.

## TOURING SEAT TYPES

Solo or two-up, comfort or style, check out these seats to get an idea of where you want to sit.

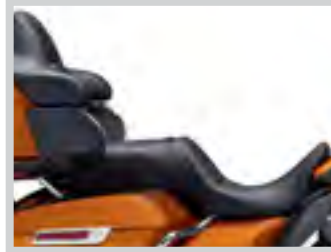

### POSITION SEATS

Designed to place the rider in the best relationship to the controls, Reach® and Tallboy® seats position short and tall riders for a comfortable extension of the arms and legs.



### TOURING SEATS

Designed for comfort, Sundowner™ and Signature Series® seats offer a broad seating surface to reduce pressure points and a dished shape holds you in place and provides additional back support.



### SUSPENSION SEATS

Harley® Hammock and Road Zeppelin® seats provide isolation from road shock with internal fabric or air bladder suspension systems that prevent "bottoming out" to increase rider comfort and endurance.

## CUSTOM SEATING PROGRAM

A personalized seat is the perfect thread to tie your bike's attitude together. Select the stitching pattern, leather inlay and thread color that best support your custom movement and you'll have your personalized seat in just three weeks. For more details, turn to page 796 or visit [h-d.com/customseat](http://h-d.com/customseat).





# TOURING & TRIKE 355

Seating – Low Profile



A. BRAWLER SOLO SEAT

## A. BRAWLER® SOLO SEAT

When it's time to go it alone, go solo in style. These premium quality cowhide leather saddles are designed to create a subtle and distinctive look. Top-grain leather seating surface and contoured foam padding add long-haul comfort and the durable hand-laid fiberglass seat pan is carpeted to protect the paint finish. Does not fit with passenger pillions.

**51525-09A** **\$349.95**

Fits '08-later Touring models. Does not fit Trike models. Does not fit models equipped with Passenger Grab Rails. Does not accept rider backrest. Seat width 13.0".

**53373-02A** **\$349.95**

Fits '97-'07 Road King® and FLHX models. Does not fit with rider backrest. Seat width 13.0".

## B. SIDEKICK® SEAT

Share your custom ride. The two-up design of these premium cowhide leather seats offers a frame-hugging look, but adds back support for the rider and additional padding for the passenger. The custom seating surface and the hand-laid fiberglass seat base show attention to detail second to none.

**51526-09A** **\$399.95**

Fits '08-later Touring models. Does not fit Trike models. Does not fit models equipped with Passenger Grab Rails. Does not accept rider backrest. Installation on '12-later CVO™ models requires removal of fender trim strips. Seat width 13.5"; passenger pillion width 6.5".

**51444-04A** **\$399.95**

Fits '97-'07 Road King and FLHX models. Does not fit with rider backrest. Seat width 13.5"; passenger pillion width 6.5".



B. SIDEKICK SEAT

*Notice: The prices appearing in this catalog are the manufacturer's suggested retail prices. Actual retail prices may vary.*

TOURING

To add custom inlays and stitching to your Brawler® or Sidekick® seat, see pages 796-797, or visit: [www.h-d.com/customseat](http://www.h-d.com/customseat).



# 356 TOURING & TRIKE

Seating – Low Profile

## A. BADLANDER® SEAT

Once again, bad is good. The popular Badlander® Custom Seat is available for your Touring model. Designed to fit your bike like a glove, this seat delivers low-slung cruiser style from rear fender to the tank console. Low and lean, the clean, smooth cover and the embroidered "Harley-Davidson" logo add up to a radical look. Does not accept a rider backrest.

**52067-08A** **\$299.95**

Fits '08-later Touring models. Does not fit Trike models. Installation on '12-later CVO™ models requires removal of fender trim strips. Seat width 13.0"; passenger pillion width 6.0".

**52066-97C** **\$299.95**

Fits '97-'07 Road King® (except FLHRS) and FLHX models. Also fits '97-'07 Electra Glide® and Road Glide® models equipped with Fuel Tank Console P/N 71288-03A or Trim Piece P/N 52447-96. Seat width 12.25"; passenger pillion width 4.5".

**52265-01A** **\$299.95**

Fits '97-'07 Electra Glide (except FLHX) and Road Glide models. Seat width 12.5"; passenger pillion width 4.5".



A. BADLANDER SEAT

## B. LOW-PROFILE SOLO TOURING SEAT – MAHOGANY BROWN

Set your custom bagger apart with a Low-Profile Solo Seat that combines street-rod style with a surprising touch of comfort. Start with a shape that distributes your weight across a wide surface area to reduce pressure points. Add a tapered nose that brings the legs closer together to shorten the reach to the ground. Finish it with rich textured mahogany-brown vinyl, upholstered in a custom diamond-pleat pattern with complementing double-row gold stitching. The result is the slammed custom seat that you crave, with enough comfort and support to let you actually spend time in the saddle. Finish the look with your choice of matching passenger pillion, sissy bar pad and Tour-Pak® backrest pad.

**52000057** **\$359.95**

Fits '09-later Touring models. Does not fit Trike models. Does not accept Rider Backrest. Seat width 15.0".

**Shown with:**

### LOW-PROFILE PASSENGER PILLION – MAHOGANY BROWN

Bring a passenger along for the ride. Dressed in rich textured brown vinyl and finished with elegant gold stitching, this Passenger Pillion is the perfect complement to the Mahogany Brown Solo Seat. Easy on-and-off installation lets you change from a two-up tourer to a stripped-down cruiser in seconds. Includes matching grab strap.

**52400040** **\$274.95**

Fits '09-later Touring models equipped with Solo Seat P/N 52000057. Pillion width 11.0". Does not fit Trike models.



B. LOW-PROFILE SOLO TOURING SEAT – MAHOGANY BROWN (SHOWN WITH LOW-PROFILE PASSENGER PILLION)

## C. LEATHER LOW-PROFILE BUCKET SEAT

A custom-look low and slammed seat, with a bucket contour for added support. Features embroidered logo and an opening that receives a matching Rider Backrest.

**52095-08A** **\$329.95**

Fits '08-later Touring and Tri Glide® models. Installation on '12-later CVO models requires removal of fender trim strips. Seat width 15.0"; passenger pillion width 8.5".

**52918-98B** **\$329.95**

Fits '97-'07 Road King (except FLHRS) and FLHX models. Also fits '97-'07 Electra Glide and Road Glide models equipped with Fuel Tank Console P/N 71288-03A or Trim Piece P/N 52447-96. Seat width 15.7"; passenger pillion width 6.5".



C. LEATHER LOW-PROFILE BUCKET SEAT

NOTE: Some Harley-Davidson® seats are made of leather. Fine leathers or other natural materials WILL gain "character," such as wrinkles or wear, with age. This is normal. A fine, aged patina and character wrinkles are a sign of the extremely high quality materials used to construct your seat or backrest. The appearance of scars or marks on the leather are a result of using natural leather panels and should not be thought of as an imperfection. Please use Harley-Davidson Leather Dressing P/N 98261-91V to protect your investment.

Notice: The prices appearing in this catalog are the manufacturer's suggested retail prices. Actual retail prices may vary.



## TOURING & TRIKE 357

Seating – Low Profile



D. RALLYRUNNER SEAT

### D. RALLYRUNNER® SEAT

The Rallyrunner® Seat features thicker padding for the rider and a wider passenger pillion for the passenger. The premium cowhide leather seating surface has a rich, luxurious feel and the carpeted hand-laid fiberglass seat base hugs the fender for a custom look. The foam padding will form to the rider's shape and provide hours of riding comfort.

**51527-09A**

**\$399.95**

Fits '08-later Touring models. Does not fit Trike models. Does not fit models equipped with Passenger Grab Rails. Does not accept rider backrest. Installation on '12-later CVO™ models requires removal of fender trim strips. Seat width 13.5"; passenger pillion width 10.0".

### E. ROAD ZEPPELIN® AIR ADJUSTABLE SEAT

The mating of comfort and style. Low-profile Road Zeppelin® Seats are equipped with a unique adjustable air bladder system that distributes your weight across the seating surface. The air bladder system removes pressure points and provides shock absorption for the rider's and passenger's tailbone. You get hours of riding comfort, without sacrificing the low-slung custom look. The combination of smooth vinyl and water-resistant textured fabric seating surfaces allows air to circulate beneath the body, reducing the air temperature between the rider and seat. The easy-to-reach integrated hand pumps and air release valves permit quick and convenient adjustment for both the rider and passenger.

**52000152**

**\$599.95**

Fits '08-later Touring models. Does not fit Trike models. Does not fit models equipped with Passenger Grab Rails or Rider Backrests. Installation on '12-later CVO models requires removal of fender trim strips. Seat width 15.5", passenger pillion width 12.0".



E. ROAD ZEPPELIN AIR ADJUSTABLE SEAT



E. ROAD ZEPPELIN AIR ADJUSTABLE SEAT

NOTE: Some Harley-Davidson® seats are made of leather. Fine leathers or other natural materials WILL gain "character," such as wrinkles or wear, with age. This is normal. A fine, aged patina and character wrinkles are a sign of the extremely high quality materials used to construct your seat or backrest. The appearance of scars or marks on the leather are a result of using natural leather panels and should not be thought of as an imperfection. Please use Harley-Davidson Leather Dressing P/N 98261-91V to protect your investment.

Notice: The prices appearing in this catalog are the manufacturer's suggested retail prices. Actual retail prices may vary.

## 358 TOURING & TRIKE

Seating – Short & Tall Rider

### REDUCED REACH® SEATS

Designed to position riders with a shorter inseam closer to the ground, Reduced Reach® Seats are shaped to place the rider in a comfortable and confident relationship to the hand and foot controls. The wide seating surface provides loads of support while riding and the narrow tapered nose brings your legs together for an easier reach to the ground at a stop. Reduced Reach Seats feature a stepped profile that provides back support and keeps the rider from sliding back during acceleration.

#### A. REDUCED REACH SEAT – '09-LATER MODELS

This Reduced Reach forward position seat brings the legs about 1.0" closer together and features enhanced back support padding that moves the rider lower and forward.\* Seat can be equipped with optional rider backrest for added support and comfort.

\*Measurements based on Original Equipment Electra Glide® seat:

'09 models – 1.0" lower, 2.5" forward

'10-'13 models – .5" lower, 2.5" forward

'14-later models – stock height, 2.0" forward

**52000131** **\$349.95**

Fits '14-later Touring and Trike models. Seat width 14.0"; passenger pillion width 13.5".

**54383-11** **\$349.95**

Fits '09-'13 Touring and Trike models. Also fits '14-later Touring models not equipped with Tour-Pak®. Installation on '12-later CVO™ models requires removal of fender trim strips. Seat width 13.0"; passenger pillion width 12.0".

#### B. REDUCED REACH SEAT – '08 MODELS

This Reduced Reach forward position seat brings the legs about 1.0" closer together so that feet rest firmly on the pavement and is shaped to move the rider approximately .5" lower\* and .5" forward. Seat can be equipped with optional rider backrest for added support and comfort.

\*Measurement based on '08 Electra Glide Original Equipment seat.

**52619-08A** **\$349.95**

Fits '08 Touring and Trike models. Seat width 15.0"; passenger pillion width 13.0".

#### C. REDUCED REACH SEAT – '97-'07 MODELS

This Reduced Reach forward position seat has a tapered nose to bring the legs closer together. The bucket-shaped pillow-look saddle features added back support padding that moves the rider approximately 1.5" lower and 1.5" forward. Seat can be equipped with an optional Rider Backrest Kit for added support.

**52544-05A** **\$349.95**

Fits '97-'07 Electra Glide (except FLHX) and '98-'07 Road Glide® models. Seat width 16.0"; passenger pillion width 13.0".

**52609-05** **\$349.95**

Fits '97-'07 Road King® (except FLHRS) and FLHX models. Also fits '97-'07 FLHT and FLTR models equipped with Fuel Tank Console P/N 71288-03A or Trim Piece P/N 52447-96. Seat width 16.0"; passenger pillion width 13.0".



A. REDUCED REACH SEAT – '09-LATER MODELS



B. REDUCED REACH SEAT – '08-LATER MODELS

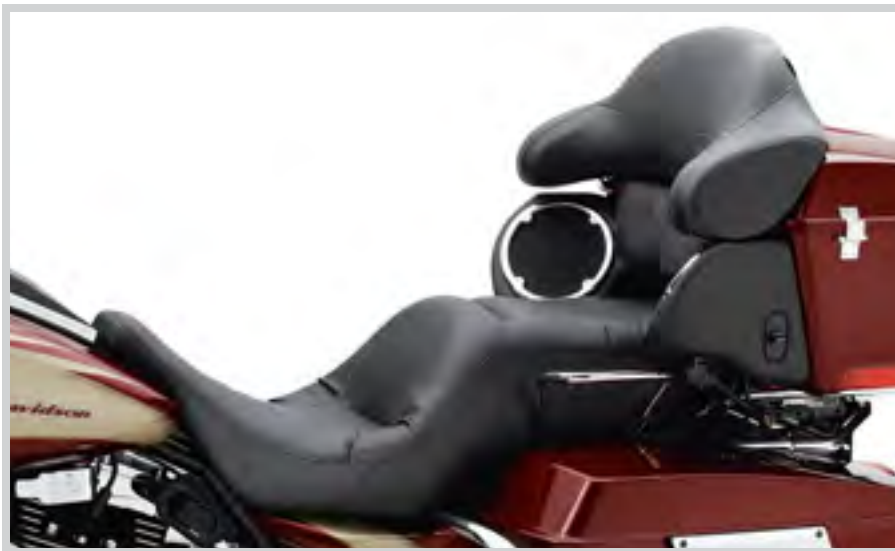

C. REDUCED REACH SEAT – '97-'07 MODELS

Notice: The prices appearing in this catalog are the manufacturer's suggested retail prices. Actual retail prices may vary.



# TOURING & TRIKE 359

Seating – Short & Tall Rider

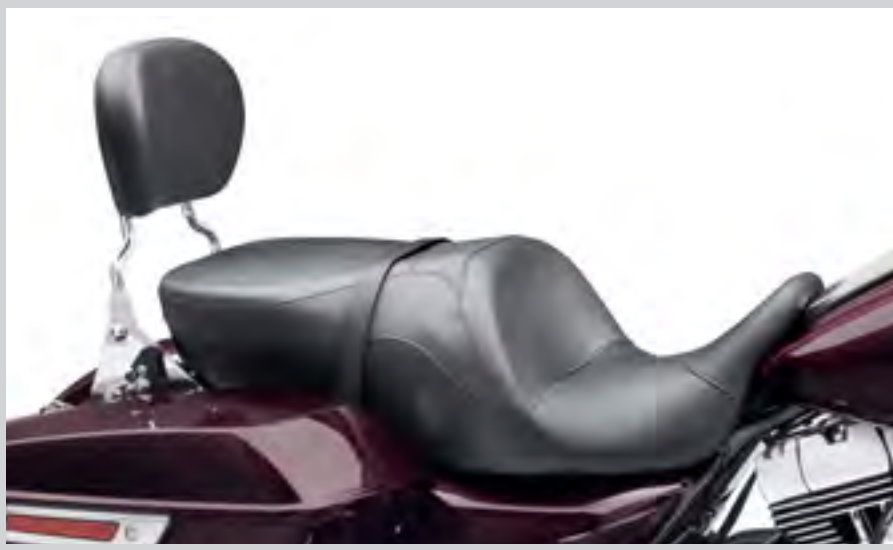

D. SUPER REDUCED REACH SEAT

## D. SUPER REDUCED REACH® SEAT

Get a little bit closer. Super Reduced Reach® forward position seats are designed to move riders with a shorter inseam even closer to the controls and to bring the legs about 1.0" closer together so that your feet rest firmly on the pavement. The scooped bucket-shape saddle is enhanced with added back support padding to move the rider lower and forward.\* The combination positions the rider closer to the hand and foot controls to offer both comfort and confidence. Seat can be equipped with optional rider backrest for added support and comfort.

\*Measurements based on Original Equipment

Electra Glide® seat:

'09 models – 2.0" lower, 2.5" forward

'10-'13 models – 1.5" lower, 2.5" forward

'14-later models – .5" lower, 2.0" forward

**52000132** **\$329.95**

Fits '14-later Touring and Tri Glide® models. Seat width 14.0"; passenger pillion width 13.5".

**54382-11** **\$349.95**

Fits '09-'13 Touring and Trike models. Also fits '14-later Touring models not equipped with Tour-Pak®. Installation on '12-later CVO™ models requires removal of fender trim strips. Seat width 13.0"; passenger pillion width 12.0".



E. TALLBOY SEAT – '08-LATER MODELS

## TALLBOY® SEATS

The correct riding position can help a tall rider sit comfortably on the bike and avoid leg cramps and back strain during a long day in the saddle. For riders with a longer inseam, a Tallboy® Seat will put you on the road to fatigue-free riding. Designed to move the rider up and back from the stock seating position, a Tallboy Seat can eliminate the "knees-high" riding position and effectively places the body for a natural arm and leg reach to the controls. Tallboy Seats feature a bucket-shaped design for added support and a wide seating surface to reduce pressure on the tailbone.

## E. TALLBOY SEAT – '08-LATER MODELS

This Tallboy Seat moves the rider back\* to provide much-needed arm and leg room for the long-limbed rider. The seat height is similar to stock and the slight bucket shape offers additional lower back support. Passenger comfort will be maximized with the Tour-Pak Luggage mounted in the rear-most position. Accepts rider backrest (except Adjustable Style) for additional touring comfort.

\*Measurements based on Original Equipment

Electra Glide seat:

'08-'13 models – stock height, 2.0" rearward

'14-later models – stock height, 1.5" rearward

**52000134** **\$349.95**

Fits '14-later Touring and Tri Glide models. Not compatible with Adjustable Rider Backrest kits or Passenger Grab Rails. Seat width 16.0"; passenger pillion width 14.5".

**52099-09A** **\$349.95**

Fits '08-'13 Touring and Trike models. Also fits '14-later Touring models not equipped with Tour-Pak. Does not fit models equipped with Adjustable Rider Backrest Kits or Passenger Grab Rails. Installation on '12-later CVO models requires removal of fender trim strips. Seat width 16.0"; passenger pillion width 14.0".



F. TALLBOY SEAT – '97-'07 MODELS

## F. TALLBOY SEAT – '97-'07 MODELS

This Tallboy one-piece seat moves the rider back .5" and up 1.25" compared to the Original Equipment seat. The new position allows additional leg and arm movement for the long-limbed rider and a comfortable seating space for the open road. The bucket design of the Tallboy Seat provides additional rider back support and the wide raised pillion places the passenger for maximum comfort and commanding view. Can also be used with Rider Backrest Kits.

**52975-05** **\$349.95**

Fits '97-'07 Electra Glide (except FLHX) and Road Glide® models. Seat width 17.5"; passenger pillion width 15.0".

**52976-05** **\$349.95**

Fits '97-'07 Road King® and FLHX models. Also fits '97-'07 Electra Glide and Road Glide models equipped with Fuel Tank Console P/N 71288-03A or Trim Piece P/N 52447-96. Seat width 17.0"; passenger pillion width 16.0".

Notice: The prices appearing in this catalog are the manufacturer's suggested retail prices. Actual retail prices may vary.

# 360 TOURING & TRIKE

Seating – Sundowner™

## SUNDOWNER™ SEATS

The Sundowner™ Seat provides the maximum in long-riding comfort. The deep-bucket design puts your body in the proper touring position and the generous padding makes it comfortable for both the rider and passenger as the miles are adding up. The dished shape back provides added rider back support and the wide passenger pillion is shaped to minimize pressure points.

### A. SUNDOWNER SEAT – SMOOTH

The smooth cover complements any Touring model. Seat accepts rider backrest for additional touring comfort.

**52000128** **\$349.95**  
Fits '14-later Touring and Tri Glide® models. Seat width 14.5"; passenger pillion width 13.0".

**52093-08A** **\$349.95**  
Fits '08-'13 Touring and Trike models. Also fits '14-later Touring models not equipped with Tour-Pak®. Installation on '12-later CVO™ models requires removal of fender trim strips. Seat width 16.0"; passenger pillion width 14.0".

**51726-05** **\$349.95**  
Fits '97-'07 Road King® and FLHX models. Also fits '97-'07 Electra Glide® and Road Glide® models equipped with Fuel Tank Console P/N 71288-03A or Trim Piece P/N 52447-96. Seat width 15.0"; passenger pillion width 12.0".

**51542-01B** **\$349.95**  
Fits '97-'07 Electra Glide (except FLHX) and Road Glide models. Seat width 16.0"; passenger pillion width 13.5".

### B. SUNDOWNER SEAT – FREEWHEELER™

This Sundowner seat is finished in rich black vinyl and is styled to complement the Freewheeler™ Trike model's Original Equipment seat.

**52000183** **\$349.95**  
Fits '15-later FLRT models. Seat width 15.0"; passenger pillion width 11.0".

### C. SUNDOWNER SEAT – ROAD KING® CLASSIC BASKETWEAVE

Decorated with pleated leather valance and chrome Road King Classic concho, the seat stays true to Road King Classic styling. Accepts rider backrest for additional touring comfort.

**51615-09A** **\$379.95**  
Fits '08-'13 Touring and Trike models. Also fits '14-later Touring models not equipped with Tour-Pak. Installation on '12-later CVO models requires removal of fender trim strips. Seat width 16.0"; passenger pillion width 14.0".

**51615-99C** **\$379.95**  
Fits '97-'07 Road King and FLHX models. Also fits '97-'07 Electra Glide and Road Glide models equipped with Fuel Tank Console P/N 71288-03A or Trim Piece P/N 52447-96. Seat width 15.0"; passenger pillion width 12.0".



A. SUNDOWNER SEAT – SMOOTH  
(52000128 SHOWN)



B. SUNDOWNER SEAT – FREEWHEELER



C. SUNDOWNER SEAT – ROAD KING CLASSIC BASKETWEAVE  
(51615-09A SHOWN)

Notice: The prices appearing in this catalog are the manufacturer's suggested retail prices. Actual retail prices may vary.



# TOURING & TRIKE 361

Seating – Sundowner™



**D. SUNDOWNER SEAT – '06-'10 STREET GLIDE STITCHING  
(51630-09A SHOWN)**

**D. SUNDOWNER™ SEAT – '06-'10 STREET GLIDE®  
STITCHING**

Decorated with “tuck and roll” pleating, the Sundowner™ Seat complements the '06-'10 Street Glide® styling. Accepts rider backrest for additional touring comfort.

**51630-09A \$369.95**

Fits '08-'13 Touring and Trike models. Also fits '14-later Touring models not equipped with Tour-Pak®. Installation on '12-later CVO™ models requires removal of fender trim strips. Seat width 16.0"; passenger pillion width 14.0".

**51630-06 \$379.95**

Fits '97-'07 FLHX and Road King® models. Also fits '97-'07 Electra Glide® and Road Glide® models equipped with Fuel Tank Console P/N 71288-03A or Trim Piece P/N 52447-96. Seat width 15.0"; passenger pillion width 12.0".

**E. SUNDOWNER SEAT – ROAD KING® BLACK STUDS**

Decorated with black studs and the embroidered Road King V-logo, the seat stays true to Road King styling. Accepts rider backrest as well for additional touring comfort.

**51617-99C \$379.95**

Fits '97-'07 Road King and FLHX models. Also fits '97-'07 Electra Glide and Road Glide models equipped with Fuel Tank Console P/N 71288-03A or Trim Piece P/N 52447-96. Seat width 15.0"; passenger pillion width 12.0".

**F. SUNDOWNER SEAT – ROAD KING CUSTOM  
STITCHING**

Decorated with complementing stitching, the Sundowner Seat holds true to the Road King Custom styling. Accepts rider backrest for additional touring comfort.

**51093-04A \$379.95**

Fits '97-'07 Road King and FLHX models. Also fits '97-'07 Electra Glide and Road Glide models equipped with Fuel Tank Console P/N 71288-03A or Trim Piece P/N 52447-96. Seat width 15.0"; passenger pillion width 12.0".



**E. SUNDOWNER SEAT – ROAD KING BLACK STUDS  
(SHOWN WITH ROAD KING PASSENGER BACKREST PAD)**



**F. SUNDOWNER SEAT – ROAD KING CUSTOM STITCHING  
(SHOWN WITH RIDER BACKREST KIT AND PASSENGER BACKREST PAD)**

TOURING

*Notice: The prices appearing in this catalog are the manufacturer's suggested retail prices. Actual retail prices may vary.*

# 362 TOURING & TRIKE

Seating – Sundowner™

## A. SUNDOWNER™ SOLO SEAT

Only one can sit on the throne. This unique seat combines the deep bucket design and added back support of the two-up Sundowner™ Seat with the stripped-down look of a solo saddle. Same great comfort as the popular two-up version, but in a solo. Matching passenger pillion is available for added versatility.

Fits '97-'07 Road King® (except FLHRS) and FLHX models. Also fits '97-'07 Electra Glide® and Road Glide® models equipped with Fuel Tank Console P/N 71288-03A or Trim Piece P/N 52447-96. All models (except FLHR) require separate purchase of Solo Seat Hardware Kit P/N 52903-01. Does not accept rider backrest. Seat width 16.0".

<b>51928-01</b>	Smooth.	<b>\$299.95</b>
<b>51092-04</b>	Road King Classic.	<b>\$319.95</b>

**Shown with:**

### SUNDOWNER PASSENGER PILLION – SMOOTH

This sculpted pillion provides your passenger with the same cushioned comfort as your Solo Sundowner Seat.

<b>51929-01</b>		<b>\$179.95</b>
-----------------	--	-----------------

Fits '97-'01 Touring models equipped with an Original Equipment or accessory solo seat (except Brawler® Solo seats). Passenger pillion width 12.5".



**A. SUNDOWNER SOLO SEAT – SMOOTH (SHOWN WITH SUNDOWNER PASSENGER PILLION)**

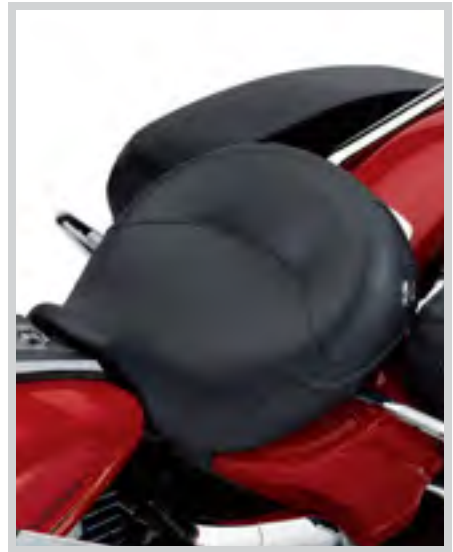

**A. SUNDOWNER SOLO SEAT – ROAD KING CLASSIC BASKETWEAVE**

## B. SIGNATURE SERIES® SOLO SEAT WITH RIDER BACKREST

The perfect combination of foam density and shape has resulted in our most comfortable seat for long-haul touring. The seat is shaped with a wide seating area to spread the pressure across the broad surface and a narrow nose area to keep your legs together for a shorter reach to the ground. The Signature Series® Solo Seat features a built-in, fully adjustable and removable rider backrest for added support. The backrest provides a 5-position height adjustment with 1.5" range and a wide range of forward/back adjustment with a quick twist of the control knob. The backrest pad features a sleek shape that provides full lower back support without pushing the rider forward. When combined with the comfortable Passenger Pillion P/N 52000133 or 51770-09 (sold separately), the slim profile of the rider backrest offers the passenger a few more inches of space and the fold-down design permits easy passenger mounting/dismounting. The rich vinyl seating surface is easy to clean and maintain and features an embossed Bar & Shield logo on the side skirts for a finishing touch.

<b>51700-09</b>		<b>\$529.95</b>
-----------------	--	-----------------

Fits '08-later Touring models. Seat width 16.5".



**B. SIGNATURE SERIES SOLO SEAT WITH RIDER BACKREST**

## C. SIGNATURE SERIES PASSENGER PILLION

This easy-to-install pillion is designed for long range passenger comfort. The wide seating surface and specific-density padding reduce pressure points and spread the weight for superior support. The smooth cover matches the Signature Series Solo Seat and the embossed Bar & Shield logo on the rear shows everyone that you are riding in style. Add a matching Smooth Passenger Backrest for the complete look.

<b>52000133</b>		<b>\$169.95</b>
-----------------	--	-----------------

Fits '14-later Touring models. Passenger pillion width 15.0".

<b>51770-09</b>		<b>\$169.95</b>
-----------------	--	-----------------

Fits '08-'13 Touring models equipped with Solo Seat P/N 51700-09. Also fits '14-later Touring models not equipped with Tour-Pak®. Installation on '12-later CVO™ models requires removal of fender trim strips. Passenger Pillion width 15.0".



**C. SIGNATURE SERIES PASSENGER PILLION**

*Notice: The prices appearing in this catalog are the manufacturer's suggested retail prices. Actual retail prices may vary.*



# TOURING & TRIKE 363

Seating – Sun Ray®



**D. SUN RAY HEATED SEAT – '14-LATER MODELS**



**D. SUN RAY HEATED SEAT – '08-'13 MODELS**



**E. SUN RAY HEATED SEAT – '97-'07 MODELS**

## **D. SUN RAY® HEATED SEAT – '08-LATER MODELS**

Chase away the chill on long fall and winter rides. This second generation heated seat features dual-zone heated rider and passenger positions with separate high/low/off toggle controls for personal comfort selection. The one-piece seat with integrated heat pad and control system is simple to install and the heating element is switched on/off with the ignition to avoid draining the battery. Smooth styling complements any Touring model. Can be used with optional Rider Backrest Kits.

**52000135** Vinyl. **\$824.95**

Fits '14-later Touring and Tri Glide® models. Separate purchase of Electrical Harness Extension P/N 69200722 is required. Seat width 15.0"; passenger pillion width 15.0".

**52633-08A** Vinyl. **\$824.95**

Fits '08-'13 Touring and Trike models. Also fits '14-later Touring models not equipped with Tour-Pak®. '14-later Touring models require the separate purchase of Electrical Harness Extension P/N 69200722. Installation on '12-later CVO™ models requires removal of fender trim strips. Seat width 15.0"; passenger pillion width 15.0".

## **E. SUN RAY HEATED SEAT – '97-'07 MODELS**

Chase away the chill on long fall and winter rides. This Sun Ray® Heated Seat features dual-zone heated rider and passenger positions with separate high/low/off toggle controls for personal comfort selection. The durable leather seating surface with embossed ostrich skin pattern covers a deep bucket rider seat and a supportive passenger pillion for cross-country comfort. The one-piece seat with integrated heat pad and control system is simple to install and the heating element is switched on/off with the ignition to avoid draining the battery. Can be used with Rider Backrest Kits.

**51718-06** Leather. **\$999.95**

Fits '97-'07 Electra Glide® (except FLHX) and '98-'07 Road Glide® models. Seat width 17.0"; passenger pillion width 16.0".

# 364 TOURING & TRIKE

Seating – Harley® Hammock

## A. HARLEY® HAMMOCK RIDER AND PASSENGER TOURING SEAT

Protect the backside of both rider and passenger from harsh road conditions. With its revolutionary suspension systems, this Harley® Hammock Rider and Passenger Touring Seat offers increased isolation from sharp road impacts. For the rider, sling-like fabric suspension system acts like a hammock to reduce impacts and the two inches of traditional foam on top provides additional support. For the passenger, a multiple spring-board style suspension system along with two inches of traditional foam provides 15% improvement in passenger comfort. The generous seat length accommodates a wide variety of rider sizes and allows fore-and-aft movement to vary the position on a long ride. Available with or without dual-zone heated rider and passenger seating areas, this seat's vinyl surface is easy to clean and maintain. Can be equipped with Rider Backrest (sold separately) on most models.

**52000177** With Heat. **\$899.95**  
Fits '14-later Touring and Tri Glide® models. Separate purchase of Electrical Harness Extension P/N 69200722 is required. Seat width 17.0"; passenger pillion width 15.0".

**52000176** Without Heat. **\$549.95**  
Fits '14-later Touring and Tri Glide models. Seat width 17.0"; passenger pillion width 15.0".

**52000004A** With Heat. **\$899.95**  
Fits '09-'13 Touring and Trike models. Also fits '14-later Touring models not equipped with Tour-Pak®. '14-later Touring vehicles require the separate purchase of Electrical Harness Extension P/N 69200722. Trike models require separate purchase of Paint Guard Kit P/N 52000013. Does not fit models equipped with Passenger Grab Rail. Installation on '12-later CVO™ models requires removal of fender trim strips. Seat width 17.5"; passenger pillion width 15.0".

**52000003A** Without Heat. **\$549.95**  
Fits '09-'13 Touring and Trike models. Also fits '14-later Touring models not equipped with Tour-Pak. Trike models require separate purchase of Paint Guard Kit P/N 52000013. Does not fit models equipped with Passenger Grab Rail. Installation on '12-later CVO models requires removal of fender trim strips. Seat width 17.5"; passenger pillion width 15.0".

**52000072** Without Heat. **\$549.95**  
Fits '97-'07 Electra Glide® and Road Glide® models. Seat width 18.0"; passenger pillion width 15.5".

**52000075** Without Heat. **\$549.95**  
Fits '97-'07 Road King® and FLHX models. Seat width 18.0"; passenger pillion width 15.5".

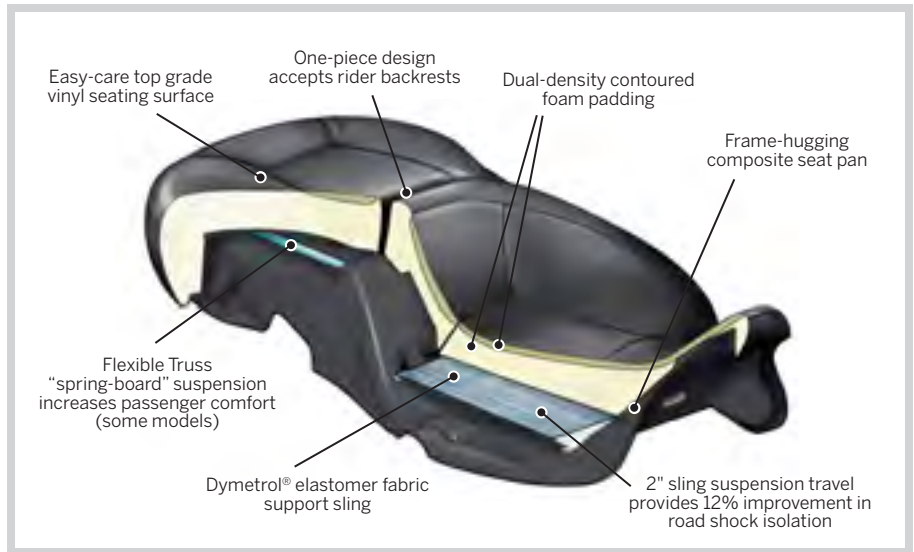

A. HARLEY HAMMOCK RIDER AND PASSENGER TOURING SEAT



A. HARLEY HAMMOCK RIDER AND PASSENGER TOURING SEAT  
'14-LATER MODELS



A. HARLEY HAMMOCK RIDER AND PASSENGER TOURING SEAT  
'97-'13 MODELS

Notice: The prices appearing in this catalog are the manufacturer's suggested retail prices. Actual retail prices may vary.



# TOURING & TRIKE 365

Seating – Harley® Hammock

## B. HARLEY® HAMMOCK RIDER TOURING SEAT

This Harley® Hammock Seat coddles the rider and supports their weight with a wide seating surface and the revolutionary sling-like fabric suspension system. The passenger rides on a generous pillion of dual-density foam, shaped for support and long-haul comfort. The Harley Hammock Seat's vinyl surface is easy to clean and maintain and is finished with a "Harley-Davidson" raised script logo. Can be equipped with Rider Backrest (sold separately) on most models.

**53051-09** **\$549.95**

Fits '08 Touring models equipped with Tour-Pak® luggage. Does not fit models equipped with Passenger Grab Rail. Installation on '12-later CVO™ models requires removal of fender trim strips. Seat width 17.5"; passenger pillion width 15.0".

## C. COMFORT STITCH SEAT

The deep bucket seat design and the smooth cover and stitching are the perfect complement to the Road King® style. The deep pocket provides additional back and thigh support for long distance comfort. Can be used with Rider Backrest Kits.

**51157-04A** **\$349.95**

Fits '97-'07 Road King and FLHX models. Also fits '97-'07 Electra Glide® and Road Glide® models equipped with Fuel Tank Console P/N 71288-03A or Trim Piece P/N 52447-96. Seat width 17.0"; passenger pillion width 16.0".

**51703-05** **\$349.95**

Fits '97-'07 Electra Glide (except FLHX) and Road Glide models. Seat width 17.0"; passenger pillion width 16.0".

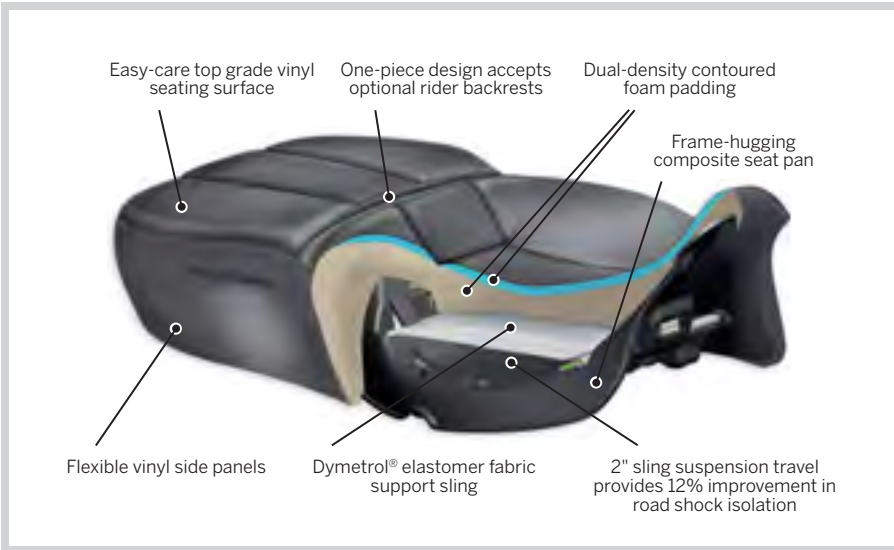

**B. HARLEY HAMMOCK RIDER TOURING SEAT**



**B. HARLEY HAMMOCK RIDER TOURING SEAT  
'08 MODELS**



**C. COMFORT STITCH SEAT FOR ROAD KING MODELS  
(SHOWN WITH COMFORT STITCH ADJUSTABLE RIDER BACKREST)**

TOURING

*Notice: The prices appearing in this catalog are the manufacturer's suggested retail prices. Actual retail prices may vary.*

# 366 TOURING & TRIKE

Seating – Road Zeppelin®

## ROAD ZEPPELIN® AIR ADJUSTABLE SEATS

The open road. That's where we developed and tested the revolutionary comfort of the Road Zeppelin® Seat. This remarkable seat removes pressure points and "hot spots" by adjusting the amount of air contained in each bladder within the seat. Easy-to-reach rocker switches on the side of the seat control the built-in compressor, adding and bleeding off air with the quick push of a button to help relieve stress from the lower back, tail-bone or lower extremities. On a long run, occasionally inflating and deflating the air bladders reduces the "numb butt" effect by improving the blood flow to the extremities. So grab a seat. And enjoy the ride.

### A. ROAD ZEPPELIN AIR ADJUSTABLE SEAT – '08-LATER MODELS

This Road Zeppelin Seat features two adjustment zones for the rider and one for the passenger and an internal air compressor that adjusts the air level nearly twice as fast as the previous version. The ergonomically-friendly seat design features a narrow front nose for ease of touching the ground at a stop, with a wide seating surface for long range rider and passenger comfort. This seat is a great addition to Trike models too. The easy-to-clean vinyl seat is finished with an embroidered Road Zeppelin logo that lets everyone see that you take riding comfort seriously. This easy-to-install seat accepts a rider backrest and passenger grab rail for additional touring comfort.

**51072-09** Comfort Stitch. **\$739.95**  
Fits '08-'13 Touring and '09-later Tri Glide® models. '14-later models requires the separate purchase of Electrical Harness Extension P/N 69200722. Installation on '12-'13 CVO™ models requires removal of fender trim strips. Seat width 20.0"; passenger pillion width 14.5".

#### Passenger Zone

Press the 3rd button to inflate and deflate the passenger area, providing maximum comfort to the backbone and support to the thigh area.

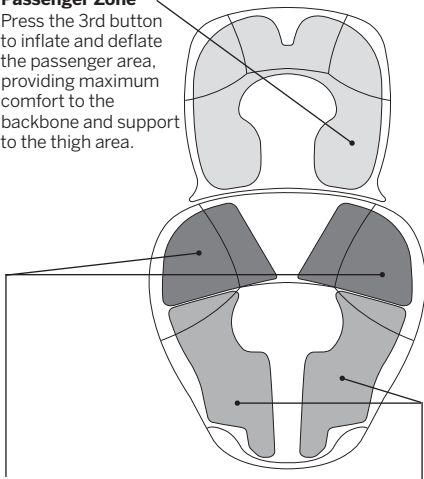

#### Lower Back Zones

Press the 2nd button (rider only) to adjust the support in the lower back zone chambers, relieving pressure points in the lower back.

#### Thigh Zones

Press the 1st button to adjust pressure in the two thigh zone chambers, improving blood flow to lower extremities and adding support to thighs.

'08-LATER MODELS



A. ROAD ZEPPELIN AIR ADJUSTABLE SEAT – '08-LATER MODELS



A. ROAD ZEPPELIN AIR ADJUSTABLE SEAT – CONTROL PANEL

*Notice: The prices appearing in this catalog are the manufacturer's suggested retail prices. Actual retail prices may vary.*



## TOURING & TRIKE 367

Seating – Road Zeppelin®



**B. ROAD ZEPPELIN AIR ADJUSTABLE SEAT – LEATHER – '97-'07 MODELS  
(SHOWN WITH RIDER AND PASSENGER BACKREST)**

### B. ROAD ZEPPELIN® AIR ADJUSTABLE SEAT – LEATHER – '97-'07 MODELS

This premium seat features leather seating surfaces for long-distance touring comfort. Kit includes protective rain cover.

**52333-97E** Leather. **\$939.95**

Fits '97-'07 Electra Glide® (except FLHX) and Road Glide® models. Seat width 21.0"; passenger pillion width 17.0".

**Shown with:**

### ROAD ZEPPELIN PASSENGER BACKREST FOR KING TOUR-PAK®

**52335-97A** **\$299.95**

Fits '97-'13 Touring and Trike models equipped with King Tour-Pak® luggage.

#### Tailbone Zones

Press the 2nd button to inflate and deflate the tailbone chamber, providing maximum comfort to the backbone.

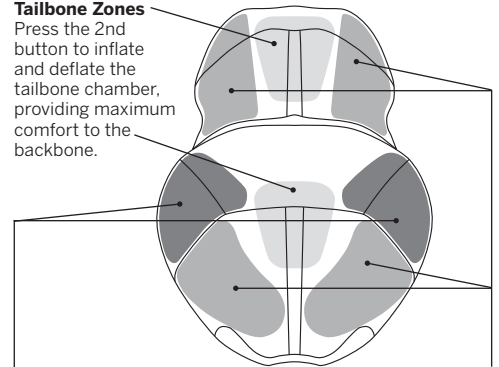

#### Lower Back Zones

Press the 3rd button (rider only) to adjust the support in the lower back zone chambers, relieving pressure points in the lower back.

#### Thigh Zones

Press the 1st button to adjust pressure in the two thigh zone chambers, improving blood flow through the lower extremities.

#### '97-'07 MODELS

### C. ROAD ZEPPELIN SEAT PAD

Experience ultimate comfort. Road Zeppelin® Seat Pads are equipped with a unique air bladder system that allows your weight to be distributed evenly across the entire seating surface, ensuring hours of comfort for both rider and passenger. The air bladder system is designed to remove pressure points and provide shock absorption to reduce vibration. The mesh cover allows air to circulate beneath the rider's body, reducing the air temperature between the rider and seat. The easy-to-reach integrated hand pump and air release valve permits quick and convenient adjustment. Shaped to conform to most Harley-Davidson® seats, the pads feature an adjustable mounting strap and a non-skid surface to keep them in place.

**52000084** Rider. **\$129.95**

Fits rider position on all models equipped with Original Equipment or accessory seats. Also fits passenger position on Touring models with large pillion area. Pad width – 14.0".

**52400060** Passenger Pillion. **\$129.95**

Fits Original Equipment and accessory passenger pillions. Pad length – 11.0"; width – 8.0".



**C. ROAD ZEPPELIN SEAT PAD**

TOURING

Notice: The prices appearing in this catalog are the manufacturer's suggested retail prices. Actual retail prices may vary.

## 368 TOURING & TRIKE

### Seating – Rider Backrests

#### A. ADJUSTABLE RIDER BACKRESTS

Add support for the long haul. With one quick pull from the integrated gas spring, you can instantly adjust the riding position through a 30-degree range. The backrest pad features a sleek shape that provides full lower back support without pushing the rider forward and a slim profile that offers the passenger a few more inches of space. The backrest features a pull knob-activated, five-position, 1.5" height adjustment. The backrest can be easily removed and folds down to allow easier passenger mounting.

Fits '97-later Touring and Tri Glide® models equipped with many one-piece slotted seats. This rider backrest may not look appropriate on select Original Equipment, CVO™ and accessory seats that are styled with a low-profile look. Installation requires separate purchase of model-specific Adjustable Rider Backrest Mounting Kit.

<b>1. 52423-09A</b>	Comfort Stitch Style.	<b>\$109.95</b>
<b>2. 52591-09A</b>	Road King® Classic Style.	<b>\$109.95</b>
<b>3. 52546-09A</b>	'06-'10 Street Glide® Style.	<b>\$109.95</b>
<b>4. 52501-09A</b>	Smooth Style.	<b>\$109.95</b>

#### Shown with:

#### ADJUSTABLE RIDER BACKREST MOUNTING KIT

Kit includes mounting bracket, adjustment handle and all required installation hardware.

**52596-09A** **\$219.95**  
Required to install Adjustable Rider Backrest on '09-later Touring models. Does not fit Trike models.

**54099-10** **\$219.95**  
Required to install Adjustable Rider Backrest on '09-later Tri Glide models.

**52593-09A** **\$219.95**  
Required to install Adjustable Rider Backrest on '97-'08 Touring models.



Pull knob in the center of backrest pad to adjust vertically to five different heights.

Push tab on side of frame to adjust angle of backrest pad 30° forward or backward.

A. ADJUSTABLE RIDER BACKREST KITS



A. ADJUSTABLE RIDER BACKRESTS (SHOWN WITH MOUNTING KIT)

*Notice: The prices appearing in this catalog are the manufacturer's suggested retail prices. Actual retail prices may vary.*



# TOURING & TRIKE 369

Seating – Rider Backrests

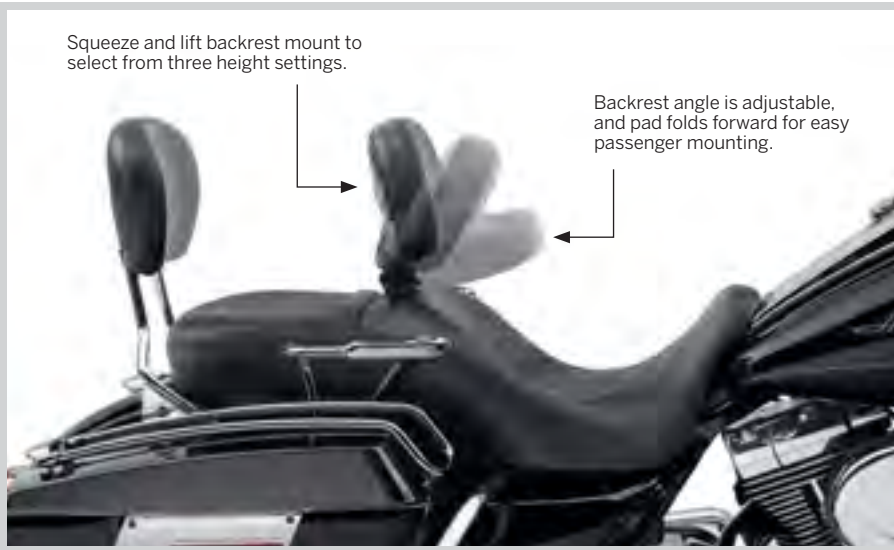

**B. RIDER BACKREST**

## B. RIDER BACKRESTS

Add back support for long-haul riding comfort. Contoured backrest pad is shaped to provide full lower back support without pushing the rider forward and the slim profile offers the passenger a few more inches of room. An adjustable support bracket with four mounting locations accommodates different seats and riding positions. The backrest pad angle can be adjusted for maximum comfort.

Fits '88-later Touring models equipped with one-piece slotted seat. Does not fit Trike models. Installation requires separate purchase of model-specific Rider Backrest Mounting Kit.

<b>1. 52572-09A</b>	Comfort Stitch Style.	<b>\$199.95</b>
<b>2. 52583-09A</b>	Road King® Classic Style.	<b>\$199.95</b>
<b>3. 51631-09A</b>	'06-'10 Street Glide® Style.	<b>\$199.95</b>
<b>4. 52900-09A</b>	Smooth Leather Style.	<b>\$219.95</b>
<b>5. 52914-09A</b>	Smooth Vinyl Style.	<b>\$199.95</b>
<b>6. 52300008</b>	'11 CVO™ Street Glide Style.	<b>\$259.95</b>

### Shown with:

#### RIDER BACKREST MOUNTING KIT

Kit includes mounting bracket and all required installation hardware.

**52589-09A** **\$44.95**  
Required to install rider backrest on '09-later Touring models. Does not fit Trike models.

**52587-09** **\$44.95**  
Required to install rider backrest on '88-'08 Touring models.



**B. RIDER BACKRESTS (SHOWN WITH MOUNTING KIT)**

# 370 TOURING & TRIKE

Seating – Accessories

## A. CIRCULATOR SEAT AND BACKREST PADS

Keep comfortable on your next long ride. These breathable Circulator Seat and Backrest Pads feature 3-D construction that promotes air movement and reduces heat build-up where the rider's body touches the seat or backrest. Designed to keep the rider cool by reducing the perspiration build-up between you and the seating surface, the Circulator Pad can be installed and removed in seconds for easy cleaning. The low-profile design minimizes seat-height change compared to inflatable pads, while enhancing comfort with its shock-absorbing construction. Manufactured of UV-stable materials, these seat and backrest pads resist fading when exposed to the sun. Elastic under-seat strap and non-slip base provide secure installation and the available Circulator Passenger Pillion Pad attaches to the rider pad with hook-and-loop tabs.

**51076-10** Large Seat Pad. **\$89.95**  
Fits Softail® and Touring models with Original Equipment and accessory seats. Will not fit Spring seats and Road Zeppelin® seats. 16.0" wide.

**51078-10** Passenger Pillion Pad. **\$69.95**  
Fits Original Equipment and accessory passenger pillions. 13.0" wide.

**52300103** Wide Backrest Pad. **\$59.95**  
Fits wide profile Rider and Passenger Backrest Pads up to 12.0" wide and 9.0" tall.

**52300105** Tour-Pak® Wrap Around Backrest. **\$69.95**  
Fits Tour-Pak Wrap Around Passenger Backrest Pads.



A. CIRCULATOR SEAT PADS (ROAD KING SHOWN)

## B. RAIN COVERS\*

Featuring a handy storage sack, this black nylon, water-resistant, Cordura® cover packs easily and shelters your seat from the storm.

**51638-97** Solo Seat. **\$29.95**  
Fits H-D® solo seats (except XR and FLSTS).

**51639-97** Touring Seat. **\$31.95**  
Fits FLSTC, FLSTS and most Touring seats. Does not fit with rider or passenger backrests.

**51637-97** Two-Up Seat. **\$31.95**  
Fits H-D two-up seats (except XR, FLSTC, FLSTS or seats with rider backrests).

**52952-97** Seat with Rider Backrest. **\$39.95**  
Fits most seats with rider backrest. Does not fit Trike models.

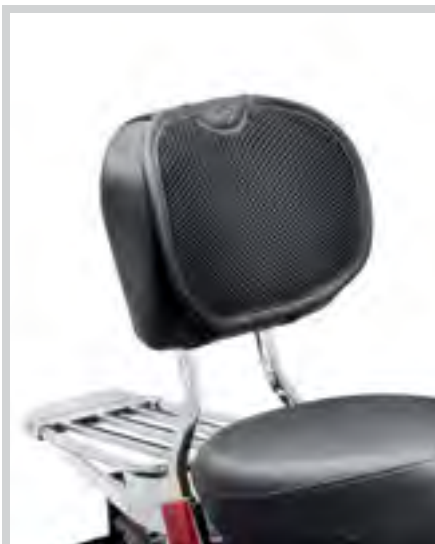

A. CIRCULATOR BACKREST PAD – WIDE



A. CIRCULATOR BACKREST PAD – WRAP AROUND



B. RAIN COVER – SOLO SEAT



B. RAIN COVER – TOURING SEAT

*Notice: The prices appearing in this catalog are the manufacturer's suggested retail prices. Actual retail prices may vary.*



# TOURING & TRIKE 371

Seating – Accessories

NEW



**C. TOUR-PAK PASSENGER ARMRESTS**  
(52400074 SHOWN)

## C. TOUR-PAK® PASSENGER ARMRESTS

If your passenger is happy, you'll be happy. Premium passenger armrests have been ergonomically designed to provide the ultimate in passenger comfort. The soft pads provide excellent forearm support on a long ride and eliminate the passenger's "what do I do with my hands" dilemma. Both armrests conveniently swing out of the way for easy mounting and dismounting and the pads and arms can be oriented in multiple positions for increased comfort. The armrest pads feature spring-loaded hinged storage compartments that can easily hold your compact personal items. The high-quality black vinyl upholstered pads and support arms blend beautifully with Original Equipment seats and speaker pods. Complete kit includes all required installation hardware.

**52400073** **\$399.95**

Fits '14-later Touring models equipped with Hard Tour-Pak® luggage (except CVO™ models). Also fits with H-D® Detachables™ Tour-Pak Mounting Racks. Does not fit Trike models.

**52400074** **\$399.95**

Fits '09-'13 Touring models equipped with Hard Tour-Pak Luggage (except CVO models). Also fits with H-D Detachables Tour-Pak Mounting racks. Does not fit Trike models. Does not fit models equipped with Ultra Boom!™ Bagger Kit P/N 76000051 or Boom! Audio Amplifier Kit P/N 76000068.

## D. FLHT/FLTR TRIM PIECE

This top-stitched trim piece opens a new world to the Standard Electra Glide® and Road Glide® model owners, allowing fitment of Road King® seats.

**52447-96** Fits '94-'07 FLHT and FLTR models. **\$29.95**

## E. TANK BRA

Manufactured from non-abrasive, fleece-backed vinyl, this Tank Bra for your Touring model features an embroidered Bar & Shield logo. It protects your fuel tank from belt buckle and key scratches and nicks from road debris. Designed for easy installation and a custom fit without tank or seat removal.

**62063-01** **\$44.95**

Fits '97-later Touring and Trike models.

NEW



**C. TOUR-PAK PASSENGER ARMRESTS**  
(52400073 SHOWN)



**C. PASSENGER ARMRESTS –**  
**RETRACTED**



**C. PASSENGER ARMRESTS –**  
**STORAGE COMPARTMENT**



**D. FLHT/FLTR TRIM PIECE**



**E. TANK BRA**

TOURING

Notice: The prices appearing in this catalog are the manufacturer's suggested retail prices. Actual retail prices may vary.

## 372 TOURING & TRIKE

Seating – Accessories

### A. PASSENGER GRAB RAIL

Add comfort and confidence for your riding companion. This easy-to-install handrail provides a convenient hand grip for your passenger and a secure tie-down point for pillion-mounted touring luggage.

Fits '14-later Touring and Tri Glide® models. Does not fit models equipped with Harley® Hammock or Tallboy® Seats.

**52400090** Chrome. **\$129.95**

**52400091** Gloss Black. **\$129.95**

Fits '09-'13 Touring models. Does not fit Trike models. Does not fit models equipped with Harley Hammock or Tallboy Seats.

**97026-09** Chrome. **\$129.95**

Fits '10-'11 FLHXXX, '06-'08 Electra Glide®, Street Glide®, Road King® and Road Glide® models. Does not fit Touring models with Tour-Pak® mounted rear speakers or models equipped with Leather Saddlebags or Harley Hammock Seats. Original Equipment on '09-'13 FLHTCUTG, '99-'05 FLHT, FLHTC and FLHTCU models.

**91583-99** Chrome. **\$129.95**



A. PASSENGER GRAB RAIL – CHROME  
(52400090 SHOWN)



A. PASSENGER GRAB RAIL – GLOSS BLACK  
(52400091 SHOWN)

### B. PASSENGER HANDRAIL COVERS

Beef up the look of the passenger handrail with these easy-to-install chrome-plated grips. The thick diameter offers a firm and comfortable hand hold for your passenger and features jet black rubber inserts, "ball-milled" grooves and Bar & Shield logo for added style. Kit includes right and left grip and stainless steel mounting hardware.

**91668-05** **\$64.95**

Fits '99-'13 Touring models equipped with Passenger Grab Rails.



A. PASSENGER GRAB RAIL  
( '09-'13 SHOWN)



B. PASSENGER HANDRAIL COVERS

### C. BILLET SEAT MOUNTING BRACKET – CHROME

The highly stylized design of this bracket adds a stunning new look to the back of most seats.

**51804-02** **\$19.95**

Replaces Bolt-On Seat Brackets P/N 51798-00, 51740-10, 52467-00, 51652-97A and 51652-83B used on most Original Equipment and accessory seats and pillions.



C. BILLET SEAT MOUNTING BRACKET – CHROME

### D. QUICK-RELEASE SEAT HARDWARE KIT

These hardware kits allow the rider to remove one-piece Harley-Davidson® seats quickly and easily.

**51676-97A** **\$19.95**

Fits '97-later XG, XL, Dyna®, Softail® (except FLS models equipped with Original Equipment seat), Touring and Trike models. Does not fit seats equipped with spring-loaded rear seat bracket.



D. QUICK-RELEASE SEAT HARDWARE KIT

*Notice: The prices appearing in this catalog are the manufacturer's suggested retail prices. Actual retail prices may vary.*



## COMFORT ON THE GO

Sometimes you need more than your bike to make it a great ride. Tour-Pak® luggage holds plenty of rain gear, extra clothing and basic supplies, while a detachable backrest means a passenger can take on the road with you.

### THE RIGHT COMBINATION



#### PUTTING IT TOGETHER

A detachable sissy bar upright and backrest pad is the starting point for a complete touring machine. Start by shopping the following pages and selecting all the components required for your particular model.

### EQUIPPED FOR THE MILES AHEAD

Solo and stripped down, two-up and fully loaded or anywhere in between, you can tailor any Harley-Davidson® motorcycle to meet the demands of the highway.



#### TWO-UP

Take a day's ride on a bike built for two. Saddlebags carry clothes and the essentials, while a Sissy Bar Backrest provides hours of passenger comfort on the open road.



#### TWO-UP TOUR-PAK® LUGGAGE

The ultimate road trip. With all this space and comfort, you and one lucky passenger are fully equipped to go wherever you want, for as long as you want. See you later.



#### SOLO TOUR-PAK LUGGAGE

Ride like you're on a mission. The saddlebags and Tour-Pak offer tons of storage space and the Solo Mounting Rack positions the Tour-Pak Pad for maximum rider back support.

### LOAD IT UP



Rain gear, extra clothing and basic supplies are easy to take along when you add luggage to your bike. Designed for maximum versatility, this complete collection of sissy bar- and luggage rack-mounted soft touring luggage ensures you will pack what you need for your next trip.

Designed by riders, for riders, the Premium Luggage Collection is formed of superior heavy-weight ballistic nylon to maintain their shape and protect your belongings over the long haul. And the secure spandex mounting system slips over the passenger backrest for a snug fit.

### CHANGING YOUR BACKREST



With a Docking Hardware Kit installed, adding or removing a detachable accessory is a simple "slide and click" proposition. Rotate the cam-lock to release the sissy bar from the rear docking points. Pivot the sissy bar forward and lift it free from the front docking points.

# 374 TOURING & TRIKE

Backrests & Racks

## A. 4-POINT DOCKING HARDWARE KIT

The ideal choice for maximum versatility, this complete kit contains the docking hardware necessary to install all H-D® Detachables™ accessory options. Even if you only install a passenger backrest today, this kit allows you to add additional accessories as your touring demands change. Provides docking points to allow installation of H-D Detachables Sissy Bar, Solo Luggage Rack, Two-Up Luggage Rack, Solo Tour-Pak® Rack or Two-Up Tour-Pak Rack.

Fits '14-later Touring models (except models equipped with rigid-mount Tour-Pak luggage).

<b>52300353</b>	Chrome.	<b>\$159.95</b>
<b>52300354</b>	Gloss Black.	<b>\$159.95</b>

Fits '09-'13 FLHR, FLHRC, FLHT, FLHX, FLTR and FLTRX, FLHRSE5, FLHXSE/2/3, FLTRSE3 and FLTRXSE/2 models. For use with H-D Detachables Sissy Bars, Solo Luggage Racks, Two-Up Luggage Racks, Solo Tour-Pak Rack and Two-Up Tour-Pak Rack. FLHRC models require separate purchase of Saddlebag Hinge Stop P/N 90580-09.

<b>54205-09A</b>	Chrome.	<b>\$159.95</b>
------------------	---------	-----------------

<b>54246-09A</b>	Gloss Black.	<b>\$159.95</b>
------------------	--------------	-----------------

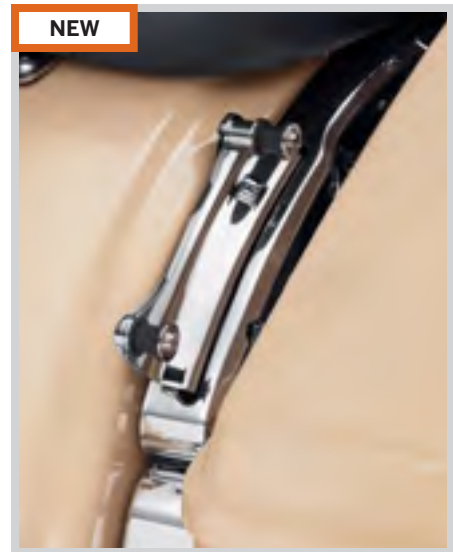

**A. 4-POINT DOCKING HARDWARE KIT – CHROME  
'14-LATER MODELS**



**A. 4-POINT DOCKING HARDWARE KIT – GLOSS BLACK  
'14-LATER MODELS**



**A. 4-POINT DOCKING HARDWARE KIT – CHROME**

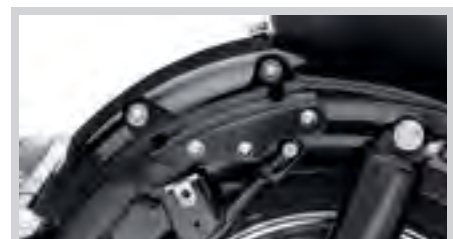

**A. 4-POINT DOCKING HARDWARE KIT  
'09-'13 MODELS**

**A. 4-POINT DOCKING HARDWARE KIT – GLOSS BLACK**

*Notice: The prices appearing in this catalog are the manufacturer's suggested retail prices. Actual retail prices may vary.*



# TOURING & TRIKE 375

Backrests & Racks

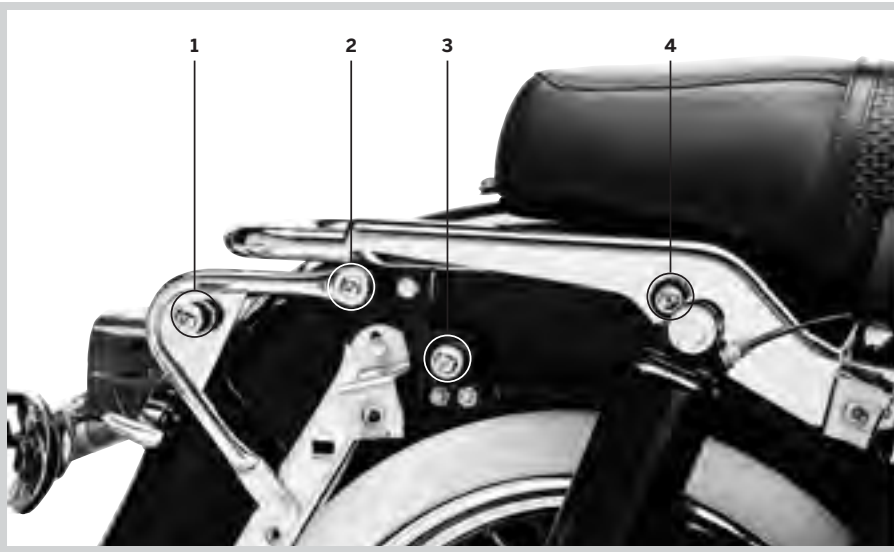

**B. H-D DETACHABLES DOCKING HARDWARE KIT – '97-'08 TOURING MODELS**

## B. H-D® DETACHABLES™ DOCKING HARDWARE KITS – '97-'08 TOURING MODELS

### For Sissy Bar, Solo Luggage Rack or Solo Tour-Pak®

Kit contains the docking hardware necessary to install H-D® Detachables™ accessories on your Road King®, Road Glide®, Street Glide® or Electra Glide® Standard model. Provides docking points to allow installation of detachable Passenger Backrest, Solo Luggage Rack or Solo Tour-Pak® Rack.

**53803-06 \$44.95**

Fits '97-'08 Touring models (except FLHTCU1 and '07-'08 FLHRSE3/4).

### For Two-Up Tour-Pak or Two-Up Luggage Rack

Kit contains the docking hardware necessary to install H-D Detachables accessories on your Road King, Road Glide, Street Glide or Electra Glide Standard model. Provides docking points to allow installation of detachable Two-Up Luggage Rack or Two-Up Tour-Pak.

**53804-06 \$59.95**

Fits '97-'08 Touring models (except FLHTCU1 and '07-'08 FLHRSE3/4).

**53988-07 \$59.95**

Fits '07-'08 FLHRSE3/4 models.

### Docking Hardware Fitment Matrix – '97-'08 Models

Touring Detachable	Docking Kit	Diagram
Sissy Bar Upright P/N 52933-97B, 52805-97B, 52935-04 or 52723-06	<b>53803-06</b>	<b>3 &amp; 4</b>
Two-Up Luggage Rack P/N 53743-97	<b>53804-06</b>	<b>1 &amp; 2</b>
Two-Up Tour-Pak Rack P/N 53276-04	<b>53804-06</b>	<b>1 &amp; 2</b>
Solo Tour-Pak Rack P/N 53260-02	<b>53803-06</b>	<b>3 &amp; 4</b>
Solo Luggage Rack P/N 53048-06	<b>53803-06</b>	<b>3 &amp; 4</b>



**C. LOCKING H-D DETACHABLES LATCH KIT – CHROME**

## C. LOCKING H-D DETACHABLES LATCH KIT

This unique lock replaces the camlock on your Harley-Davidson® Detachables accessories, providing additional security and peace of mind when parking your vehicle. The kit includes two extended-reach barrel-style keys for easy access to the lock. Key registration and replacement service is available.

Fits all models equipped with detachable Sideplates, Racks and Tour-Pak Luggage Carriers (except '09-later Touring models equipped with detachable Solo Tour-Pak Rack).

**90300087 Chrome. \$79.95**

**90300086 Black. \$69.95**

## D. H-D DETACHABLES LATCH KIT – CHROME

Decorative chrome latches are the perfect way to enhance the appearance of your detachable accessories. Meticulously polished and chrome-plated, these easy-to-install rotary latches are a direct replacement for the Original Equipment satin black parts and are a simple way to add a finishing touch to your ride. Latches feature an easy-to-pull finger release to simplify access in hard-to-reach areas.

**12600036 \$49.95**

Fits all models equipped with detachable Sideplates, One-Piece Sissy Bar Uprights, Racks and Tour-Pak Luggage Mounting Racks.



**C. LOCKING H-D DETACHABLES LATCH KIT – BLACK**

**D. H-D DETACHABLES LATCH KIT – CHROME**

*Notice: The prices appearing in this catalog are the manufacturer's suggested retail prices. Actual retail prices may vary.*

# 376 TOURING & TRIKE

## Backrests & Racks

### A. H-D® DETACHABLES™ SISSY BAR UPRIGHT

A sissy bar and passenger backrest pad is the starting point for building a complete touring machine. The backrest provides long-range comfort and support and adds a feeling of confidence and control for the passenger. Available in your choice of height, these H-D® Detachables™ One-Piece Uprights can be installed or removed in seconds to add versatility to your ride. A wide variety of Backrest Pads are available for separate purchase.

Fits '09-later Touring models equipped with required Docking Hardware Kits. '09-later Touring models equipped with rigid-mount Tour-Pak® require purchase of appropriate H-D Detachables Tour-Pak Conversion Kit.

<b>52610-09</b>	Short – Chrome.	<b>\$179.95</b>
<b>54248-09</b>	Short – Gloss Black.	<b>\$179.95</b>
<b>52627-09</b>	Standard-Height – Chrome.	<b>\$179.95</b>
<b>54247-09</b>	Standard-Height – Gloss Black.	<b>\$179.95</b>

Fits '97-'08 Road King®, FLHT, FLHX and FLTR models equipped with required Docking Kits. Fits '06-'08 FLHTC models equipped with H-D Detachables Tour-Pak Rack Mounting Kit P/N 53303-07 and Docking Hardware Kit P/N 53803-06.

<b>52935-04</b>	Short – Chrome.	<b>\$179.95</b>
<b>52933-97B</b>	Standard-Height – Chrome.	<b>\$179.95</b>
<b>52723-06</b>	Tall – Chrome.	<b>\$179.95</b>

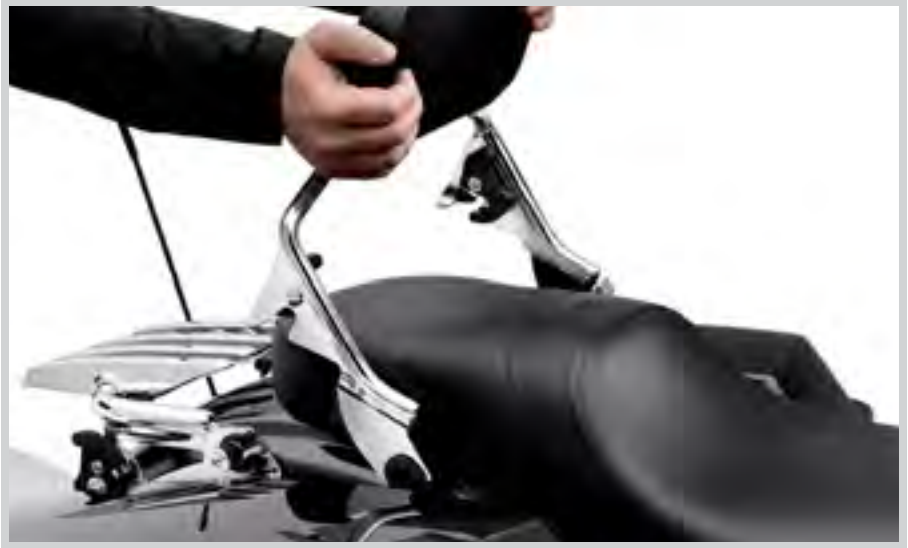

**A. H-D DETACHABLES SISSY BAR UPRIGHT – '09-LATER TOURING MODELS**

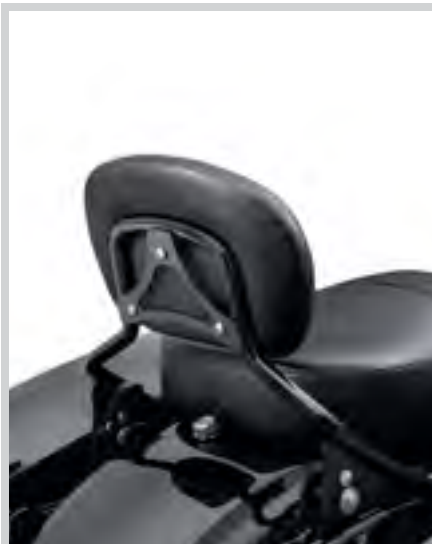

**A. SHORT H-D DETACHABLES SISSY BAR UPRIGHT – GLOSS BLACK**



**A. STANDARD-HEIGHT H-D DETACHABLES SISSY BAR UPRIGHT – CHROME**



**A. H-D DETACHABLES SISSY BAR UPRIGHT – '09-LATER MODELS**

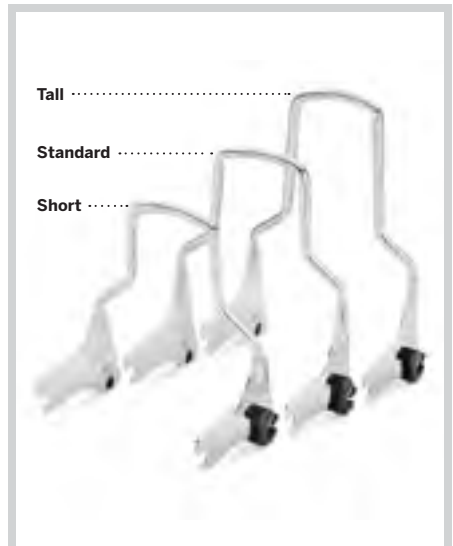

**A. H-D DETACHABLES SISSY BAR UPRIGHT – '97-'08 MODELS**

*Notice: The prices appearing in this catalog are the manufacturer's suggested retail prices. Actual retail prices may vary.*



# TOURING & TRIKE 377

## Backrests & Racks



**B. PREMIUM H-D DETACHABLES BACKREST WITH ADJUSTABLE RECLINE**



### B. PREMIUM H-D® DETACHABLES™ BACKREST WITH ADJUSTABLE RECLINE

Enhance your passenger's ride with an adjustable passenger backrest. This adjustable backrest allows the passenger to change the recline angle for maximum comfort. Simply turn the glove-friendly locking knobs and adjust the upright to one of three different recline settings. The 3 position settings provide 16 degrees of adjustment, with the mid-position that matches a standard backrest recline. The exclusive cam lock H-D® Detachables™ design lets you add or remove the passenger backrest assembly in seconds. Available in chrome and gloss black finishes.

Fits '09-later Touring models equipped with required Docking Hardware Kits (except models equipped with Stealth Detach Luggage Rack). '09-later Touring models equipped with rigid-mount Tour-Pak® require purchase of appropriate H-D Detachables Tour-Pak Conversion Kit.

<b>52300257</b>	Standard-Height – Chrome.	<b>\$299.95</b>
<b>52300258</b>	Standard-Height – Gloss Black.	<b>\$299.95</b>

### C. AIR WING SISSY BAR UPRIGHT

Combine long-range comfort with an impressive dose of style. The Air Wing Sissy Bar Upright features a sleek tapered profile capped with a beautifully crafted billet airfoil casting. The detachable sissy bar is designed to be installed or removed in seconds, adding versatility to your ride. Finish the look with the matching Air Wing Sissy Bar Backrest Pad P/N 52300302 and complementing Air Wing Two-Up Luggage Rack. The bar can be equipped with optional LED Light Kit P/N 68000076 (Red) or 68000077 (Smoked) for added rear visibility. Requires separate purchase of Wiring Harness P/N 70641-08.

Fits '09-later Touring models equipped with required Docking Hardware Kits (except models equipped with Stealth Detach Luggage Rack). '09-later Touring models equipped with rigid-mount Tour-Pak® require purchase of appropriate H-D Detachables Tour-Pak Conversion Kit.

<b>52300146</b>	Chrome.	<b>\$259.95</b>
<b>52300147</b>	Gloss Black.	<b>\$259.95</b>

#### Also available:

#### LED LIGHT KIT

This fast-acting LED Light Kit operates as a supplemental rear running light and brake light. The high, center-mount position places the light in the line-of-sight of following vehicles and the bright, fast-acting LED lamps get you noticed. Wiring is concealed inside the tubes for a clean, custom installation. Available with red or smoked lens.

Fits Air Foil Luggage Rack P/N 54290-11, 54291-11 and Air Wing Sissy Bar Upright P/N 52300146 and 52300147. Installation requires separate purchase of model-specific Wiring Harness Kit.

<b>68000076</b>	Red Lens.	<b>\$44.95</b>
<b>68000077</b>	Smoked Lens.	<b>\$44.95</b>

#### Also available:

#### LED LIGHT KIT WIRING HARNESS

Required for installation of LED Light Kit on Air Wing Sissy Bar Upright P/N 52300146 or 52300147.

<b>70641-08</b>		<b>\$13.95</b>
Fits '09-'13 Touring models equipped with Air Wing Sissy Bar Upright P/N 52300146 or 52300147.		

#### LED LIGHT KIT WIRING HARNESS

Required for installation of optional LED Light Kit on Luggage Racks and Passenger Backrests.

<b>69200772</b>		<b>\$14.95</b>
Fits '14-later Touring models equipped with Adjustable Luggage Rack P/N 50300044 or 50300076, Air Wing Racks P/N 54283-09, 50300008, 79179-08 or 53000062 and Air Wing Passenger Backrests P/N 52300146 or 52300147.		



**B. PREMIUM H-D DETACHABLES BACKREST WITH ADJUSTABLE RECLINE – CHROME**



**B. PREMIUM H-D DETACHABLES BACKREST WITH ADJUSTABLE RECLINE – GLOSS BLACK**

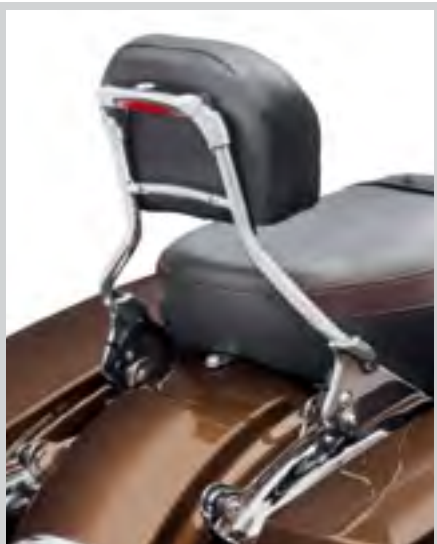

**C. AIR WING SISSY BAR UPRIGHT – CHROME**

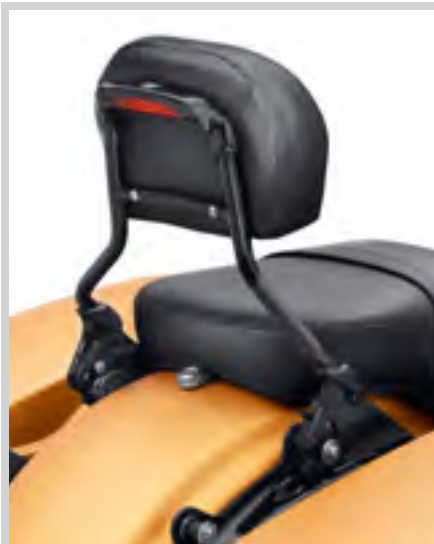

**C. AIR WING SISSY BAR UPRIGHT – GLOSS BLACK**

Notice: The prices appearing in this catalog are the manufacturer's suggested retail prices. Actual retail prices may vary.

# 378 TOURING & TRIKE

## Backrests & Racks

### A. COMPACT PASSENGER BACKREST PAD

Sized to complement low-profile custom seats, this Compact Leather Backrest Pad combines practical passenger support with custom compact style. The leather cover with smooth insert complements both synthetic and leather seating surfaces.

**52408-07A** **\$199.95**

Fits Short H-D® Detachables™ Passenger Sissy Bar Upright P/N 52935-04, 52610-09 or 54248-09. Will not fit seats with tall passenger pillion pads. Pad height 6.5"; width 10.5".



A. COMPACT PASSENGER BACKREST PAD



### B. SHORT PASSENGER BACKREST PAD – SMOOTH LOOK

Smooth top-stitched pad complements most seating surfaces.

**51579-05A** **\$109.95**

Fits Short H-D Detachables Passenger Sissy Bar Upright P/N 52935-04, 52610-09 or 54248-09. Will not fit seats with tall passenger pillion pads. Pad height 6.5"; width 10.5".

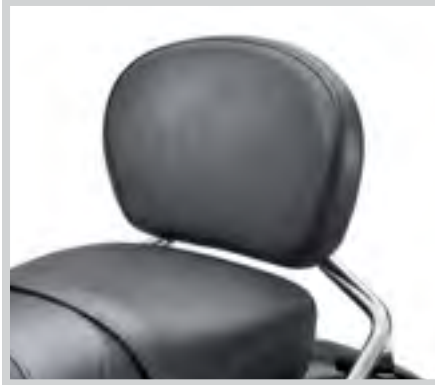

B. SHORT PASSENGER BACKREST PAD – SMOOTH LOOK

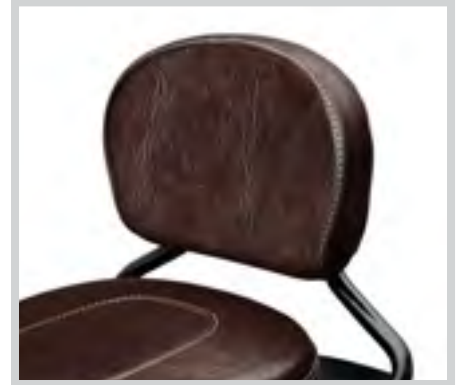

C. SHORT PASSENGER BACKREST PAD – MAHOGANY BROWN

### C. SHORT PASSENGER BACKREST PAD – MAHOGANY BROWN

Dressed in rich textured brown vinyl and finished with elegant gold stitching, this Short Passenger Backrest Pad is the perfect complement to the Mahogany Brown Seat and Pillion collection. Styled to match the '12 FLTRXSE model.

**52300141A** **\$119.95**

Fits Short H-D Detachables Passenger Sissy Bar Upright P/N 52935-04, 52610-09 or 54248-09. Will not fit seats with tall passenger pillion pads. Pad height 6.5"; width 10.5".

### D. SHORT PASSENGER BACKREST PAD – CVO ROAD GLIDE CUSTOM STYLING

Matches '13 CVO™ Road Glide® Original Equipment seat. (except the 110th Anniversary edition CVO FLTRXSE2).

**52300300** **\$129.95**

Fits Short H-D Detachables Passenger Sissy Bar Upright P/N 52935-04, 52610-09 or 54248-09. Will not fit seats with tall passenger pillion pads. Pad height 6.5"; width 10.5".

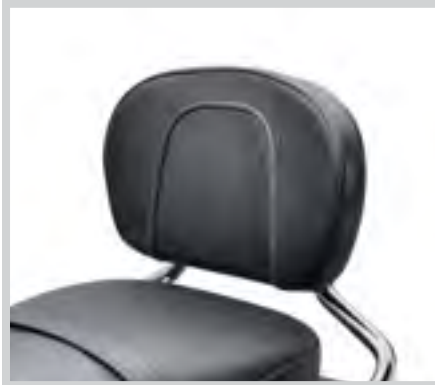

D. SHORT PASSENGER BACKREST PAD – CVO ROAD GLIDE CUSTOM STYLING



E. SHORT PASSENGER BACKREST PAD – CVO STREET GLIDE CUSTOM STYLING

### E. SHORT PASSENGER BACKREST PAD – CVO STREET GLIDE CUSTOM STYLING

Matches '15 CVO™ Street Glide® Original Equipment seat.

**52300361** **\$129.95**

Fits Short H-D Detachables Passenger Sissy Bar Upright P/N 52935-04, 52610-09 or 54248-09. Will not fit seats with tall passenger pillion pads. Pad height 6.5"; width 10.5".

### F. AIR WING PASSENGER BACKREST PAD

Styled to complement available touring and custom seats, this pad is shaped to fit the contour of the Air Wing Sissy Bar Upright P/N 52300146 or 52300147.

**52300302** **\$99.95**

Fits '09-later Touring models equipped with the Air Wing Sissy Bar Upright P/N 52300146 or 52300147.



F. AIR WING PASSENGER BACKREST PAD

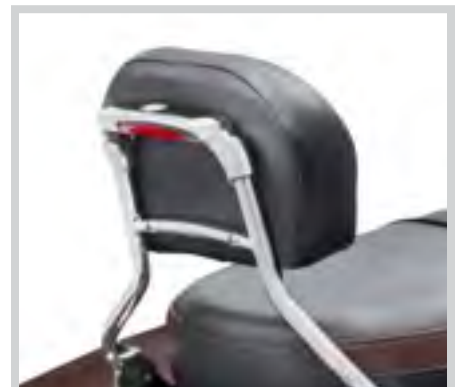

Notice: The prices appearing in this catalog are the manufacturer's suggested retail prices. Actual retail prices may vary.



# TOURING & TRIKE 379

## Backrests & Racks



**G. MID-SIZED PASSENGER BACKREST PAD – LEATHER**

### PASSENGER BACKREST PADS – MID-SIZED

Sized to fit Standard-Height and Tall Touring Sissy Bar Uprights. Available to match a wide variety of seat stitch designs, these Mid-Sized Backrest Pads feature a gentle curved shape that cradles the spine and provides hours of passenger comfort.

Fits Standard-Height H-D® Detachables™ Passenger Sissy Bar Uprights P/N 52300324, 52627-09, 54247-09, 52933-97B or 52805-97B, Tall H-D Detachables Passenger Sissy Bar Upright P/N 52723-06, Premium H-D Detachables Sissy Bar Upright 52300257 or 52300258. Pad height 8.0"; width 12.0".

### G. MID-SIZED PASSENGER BACKREST PAD – LEATHER

Styled to match Leather Low-Profile Bucket Seat P/N 52918-98A.

**52920-98B** **\$119.95**

### H. MID-SIZED PASSENGER BACKREST PAD – TOP-STITCHED

Smooth top-stitched pad complements most seating surfaces.

**52924-98B** **\$109.95**

### I. MID-SIZED PASSENGER BACKREST PAD – COMFORT STITCH

Styled to match Comfort Stitch Seats and Rider Backrests.

**51727-05A** **\$109.95**

### J. MID-SIZED PASSENGER BACKREST PAD – CUSTOM STITCHING

Styled to match Road King® Custom models.

**52657-04B** **\$99.95**

### K. MID-SIZED PASSENGER BACKREST PAD – '06-'10 STREET GLIDE® STITCHING

Styled to match the '06-'10 Street Glide® model.

**51633-06A** **\$109.95**

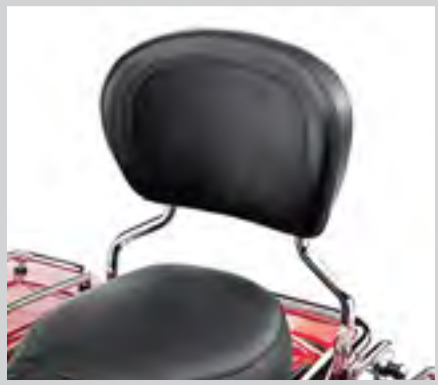

**H. MID-SIZED PASSENGER BACKREST PAD – TOP-STITCHED**

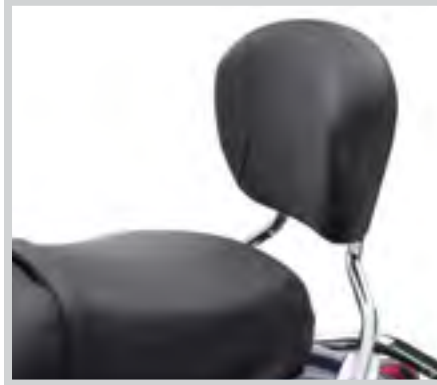

**I. MID-SIZED PASSENGER BACKREST PAD – COMFORT STITCH**

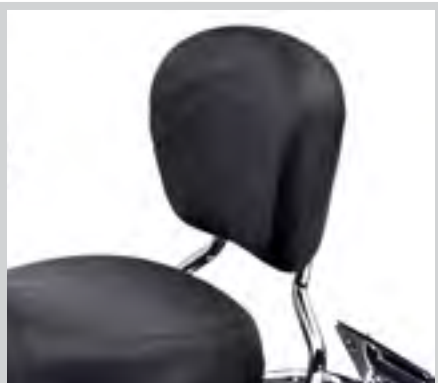

**J. MID-SIZED PASSENGER BACKREST PAD – CUSTOM STITCHING**



**K. MID-SIZED PASSENGER BACKREST PAD – STREET GLIDE STITCHING**

### PASSENGER BACKREST PADS – OVERSIZED

Sized to fit Standard-Height and Tall Touring Sissy Bar Uprights. Available to match a wide variety of seat stitch designs, these Oversized Backrest Pads feature a large surface area and a generous curved shape that surrounds the passenger's lower back and provides added support for hours in the saddle.

Fits Standard-Height H-D Detachables Passenger Sissy Bar Uprights P/N 52300324, 52627-09, 54247-09, 52933-97B or 52805-97B, Tall H-D Detachables Passenger Sissy Bar Upright P/N 52723-06, Premium H-D Detachables Sissy Bar Upright 52300257 or 52300258. Pad height 9.5"; width 13.5".

### L. OVERSIZED PASSENGER BACKREST PAD – SMOOTH

Smooth top-stitched pad complements most seating surfaces.

**52886-98D** **\$109.95**

### M. OVERSIZED PASSENGER BACKREST PAD – STUDDED

Styled to match studded Original Equipment Road King and Road King Touring Seat P/N 51617-99C.

**52709-97C** **\$109.95**



**L. OVERSIZED PASSENGER BACKREST PAD – SMOOTH**



**M. OVERSIZED PASSENGER BACKREST PAD – STUDDED**

TOURING

*Notice: The prices appearing in this catalog are the manufacturer's suggested retail prices. Actual retail prices may vary.*

# 380 TOURING & TRIKE

## Backrests & Racks

### A. BILLET BACKREST PAD MOUNT

Chrome-plated billet aluminum and an engraved Bar & Shield emblem set the tone for this custom Passenger Backrest Mount, which will make you look even better as you're rolling by. Replaces the stock mounting plate and includes chrome-plated mounting hardware.

**53086-04** Chrome. **\$69.95**

Fits Touring models equipped with H-D® Detachables™ Sissy Bar Upright P/N 52805-97B, 52933-97B, 52935-04, 52723-06, 52610-09, 52627-09, 25300257 or 52300258.

### B. STYLED BACKREST PAD MOUNT

This custom Backrest Mounting Plate replaces the stamped metal mount for a distinctive look. The mirror-finished bracket, chrome-plated mounting hardware and Vivid Black insert contrasts with a leather or vinyl backrest pad to dress your Touring bike in style.

**52825-05** Chrome. **\$49.95**

Fits Touring models equipped with H-D Detachables Sissy Bar Upright P/N 52805-97B, 52933-97B, 52935-04, 52723-06, 52610-09, 52627-09, 25300257 or 52300258.

### C. QUICK-RELEASE Sissy BAR UPRIGHT – FREEWHEELER™ MODELS

Add passenger comfort and support to your Freewheeler™ Trike model. Designed to blend with the curved lines of the trunk lid, this standard-height polished chrome upright plugs into the Original Equipment docking ports and can be removed in seconds with a simple push of the release buttons. The one-piece upright accepts most mid-sized or oversized touring model passenger backrest pads (sold separately) and is the perfect finishing element for your long-distance touring machine.

**52300324** Chrome. **\$249.95**

Fits '15-later FLRT models.

### D. AIR WING LUGGAGE RACK – FREEWHEELER MODELS

The low-profile aerodynamic styling of the Air Wing Luggage Rack draws your eye with its sleek lines and the engraved Harley-Davidson script adds a signature touch. This full-sized rack protects the trunk lid from scratches. The die-cast wing and lightweight steel tubing are hand-polished before finishing for long-lasting beauty. Kit includes all necessary mounting hardware.

**50300097** Chrome. **\$199.95**

Fits '15-later FLRT models.



A. BILLET BACKREST PAD MOUNT

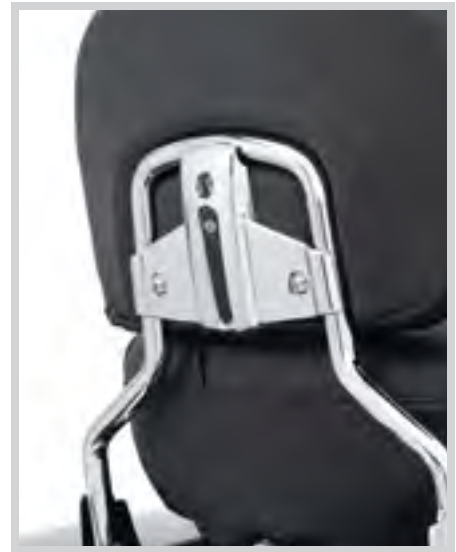

B. STYLED BACKREST PAD MOUNT

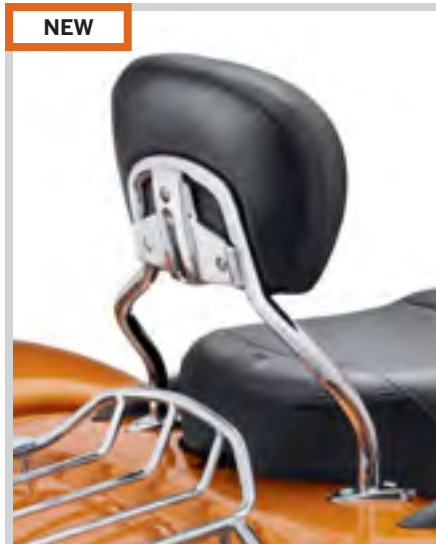

C. QUICK-RELEASE Sissy BAR UPRIGHT – FREEWHEELER MODELS (SHOWN WITH STYLED BACKREST MOUNT)



D. AIR WING LUGGAGE RACK – FREEWHEELER MODELS

Notice: The prices appearing in this catalog are the manufacturer's suggested retail prices. Actual retail prices may vary.



# TOURING & TRIKE 381

## Backrests & Racks



**E. ADJUSTABLE TWO-UP LUGGAGE RACK – CHROME (CLOSED)**



**E. ADJUSTABLE TWO-UP LUGGAGE RACK – CHROME (OPEN)**



**E. ADJUSTABLE TWO-UP LUGGAGE RACK – FINGERTIP CONTROL**



**E. ADJUSTABLE TWO-UP LUGGAGE RACK – GLOSS BLACK (CLOSED)**



**F. KING H-D DETACHABLES TWO-UP LUGGAGE RACK – CHROME**



**F. KING H-D DETACHABLES TWO-UP LUGGAGE RACK – GLOSS BLACK**

### E. ADJUSTABLE TWO-UP LUGGAGE RACK\*

Expand your options at the push of a button. This stylish rack offers style, function and practicality in one. The Adjustable Two-Up Luggage Rack features telescoping side extensions that allow the rider to customize the rack's width in seconds. To accommodate a wide soft bag or duffel, just press the buttons, slide out the side extensions and increase the usable surface area by 50%. When an oversize rack is not required, just slide in the extensions for a clean look. The beefy rack accommodates a load capacity up to 30 pounds and the side rails feature convenient mounting points that easily accept bag tie-down straps and bungee cords. The H-D® Detachables™ rack can be completely removed from the bike in seconds and is designed to accept the internally-wired LED Light Kit P/N 68065-10 or 68219-10 (sold separately) for added visibility from the rear. Rack Dimensions: 12.0" D x 12.75" W (Unexpanded); 12.0" D x 18.75" W (Expanded).

Fits '09-later Touring models equipped with 4-Point Docking Hardware Kits (except '09-later CVO™ models with rigid-mount Tour-Pak®). Models equipped with Original Equipment rigid-mount Tour-Pak require purchase of appropriate H-D Detachables Tour-Pak Rack Kit. FLHX, FLHXS, FLTR and FLTRX models require separate purchase of Antenna Relocation Kit or Hidden Antenna Kit. Some FLHRC EU registration plates may interfere with rack.

<b>50300044</b>	Chrome.	<b>\$399.95</b>
<b>50300076</b>	Gloss Black.	<b>\$399.95</b>

#### Also available:

#### LED LIGHT KIT

Fast-acting LED Light Kit operates as a supplemental rear running light and brake light. The high, center-mount position places the light in the line-of-sight of following vehicles and the bright, fast-acting red LED lamps get you noticed. Wiring is concealed inside the rack for a clean, custom installation. Available with red or smoked lens.

Fits '14-later Touring models equipped with Air Wing H-D Detachables Luggage Rack P/N 54283-09 and 50300008 and Adjustable Two-Up Luggage Rack P/N 50300044 or 50300076. Does not fit CVO models.

<b>68000111</b>	Red Lens.	<b>\$69.95</b>
<b>68000116</b>	Smoked Lens.	<b>\$69.95</b>

Fits '09-'13 Touring models equipped with Air Wing H-D Detachables Luggage Rack P/N 54283-09 and 50300008, Adjustable Two-Up Luggage Rack P/N 50300044 and 50300076. Does not fit CVO models.

<b>68065-10</b>	Smoked Lens.	<b>\$59.95</b>
<b>68219-10</b>	Red Lens.	<b>\$54.95</b>

### F. KING H-D® DETACHABLES™ TWO-UP LUGGAGE RACK\*

This stylish oversized King Two-Up Luggage Rack adds extra capacity for your cross-town or cross-country ride. The classic harp-shaped rack is constructed of large diameter steel rod, welded and perfectly polished for an elegant look. This rack is first in class with an increased load capacity up to 30 pounds. The large rack with side extensions offers a versatile flat load surface and the slotted side plates provide options for securing soft or rigid carrying bags. Designed to work with or without a H-D Detachables Passenger Backrest, the rack can be installed or removed from the bike in seconds.

Fits '09-later Touring models equipped with 4-point Docking Hardware Kits. '09-later Touring models equipped with rigid-mount Tour-Pak require purchase of appropriate H-D Detachables Tour-Pak Conversion Kit. FLHX, FLHXS, FLTR and FLTRX models require separate purchase of Antenna Relocation Kit or Hidden Antenna Kit. Some FLHRC EU registration plates may interfere with rack.

<b>50300054</b>	Chrome.	<b>\$234.95</b>
<b>50300058</b>	Gloss Black.	<b>\$234.95</b>



**\*WARNING:** Do not use this rack as a seat. Do not exceed the fender rack weight capacity. Using as seat or exceeding this capacity could cause handling problems which could result in loss of control and death or serious injury.

*Notice: The prices appearing in this catalog are the manufacturer's suggested retail prices. Actual retail prices may vary.*

# 382 TOURING & TRIKE

## Backrests & Racks

### A. AIR WING H-D® DETACHABLES™ TWO-UP LUGGAGE RACK\*

The low-profile aerodynamic styling defines the look of this Luggage Rack. Designed to work with or without H-D® Detachables™ Passenger Backrests, this rack can be installed or removed from the Docking Hardware in seconds, creating a truly versatile ride. Available in mirror chrome or rich gloss black finish, the rack draws your eye with its sleek lines and the engraved Harley-Davidson script adds a signature touch. The die-cast wing and lightweight steel tubing are hand-polished before finishing for long-lasting beauty. Kit includes all necessary mounting hardware. For added visibility, the rack is designed to incorporate the internal wiring of the Air Wing Rack Light Kit (sold separately) for a clean look.

Fits '09-later Touring models equipped with 4-point Docking Hardware Kits. '09-later Touring models equipped with rigid-mount Tour-Pak® require purchase of appropriate H-D Detachables Tour-Pak Conversion Kit. FLHX, FLHXS, FLTR and FLTRX models require separate purchase of Antenna Relocation Kit or Hidden Antenna Kit. Some FLHRC EU registration plates may interfere with rack.

<b>54283-09</b>	Chrome.	<b>\$249.95</b>
<b>50300008</b>	Gloss Black.	<b>\$249.95</b>



**A. AIR WING H-D DETACHABLES TWO-UP LUGGAGE RACK – GLOSS BLACK**



**A. AIR WING H-D DETACHABLES TWO-UP LUGGAGE RACK – CHROME**

### B. LED LIGHT KIT

Fits '14-later Touring models equipped with Air Wing H-D Detachables Luggage Rack P/N 54283-09 and 50300008 or Adjustable Two-Up Luggage Rack P/N 50300044 and 50300076. Requires separate purchase of model-specific wiring harness. Does not fit CVO™ models.

<b>68000111</b>	Red Lens.	<b>\$69.95</b>
<b>68000116</b>	Smoked Lens.	<b>\$69.95</b>

Fits '09-'13 Touring models equipped with Air Wing H-D Detachables Luggage Rack P/N 54283-09 and 50300008 or Adjustable Two-Up Luggage Rack P/N 50300044 and 50300076. Does not fit CVO models.

<b>68065-10</b>	Smoked Lens.	<b>\$59.95</b>
<b>68219-10</b>	Red Lens.	<b>\$54.95</b>



**B. AIR WING LUGGAGE RACK LED LIGHT KIT**



**B. AIR WING LUGGAGE RACK LED LIGHT KIT**

### C. STEALTH H-D DETACHABLES TWO-UP LUGGAGE RACK\*

Style and practicality in one. This classic four-bar H-D Detachables Luggage Rack flows with the long and lean lines of today's custom rides. The rails and curving support blend together for an integrated floating look and the "stealth" hidden hardware adds to the clean design.

Fits '09-later Touring models equipped with 4-point Docking Hardware Kits (except '09-later Touring models equipped with Premium H-D Detachables Backrest with Adjustable Recline P/N 523000257 and 523000258). '09-later Touring models equipped with rigid-mount Tour-Pak require purchase of appropriate H-D Detachables Tour-Pak Conversion Kit. FLHX, FLHXS, FLTR and FLTRX models require separate purchase of Antenna Relocation Kit or Hidden Antenna Kit. Some FLHRC EU registration plates may interfere with rack.

<b>53472-09</b>	Chrome.	<b>\$299.95</b>
<b>53566-09</b>	Gloss Black.	<b>\$299.95</b>

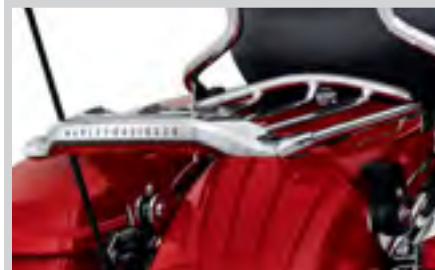

**C. STEALTH H-D DETACHABLES LUGGAGE RACK – CHROME**



**C. STEALTH H-D DETACHABLES LUGGAGE RACK – GLOSS BLACK**



**\*WARNING:** Do not use this rack as a seat. Do not exceed the fender rack weight capacity. Using as seat or exceeding this capacity could cause handling problems which could result in loss of control and death or serious injury.

*Notice: The prices appearing in this catalog are the manufacturer's suggested retail prices. Actual retail prices may vary.*



# TOURING & TRIKE 383

## Backrests & Racks

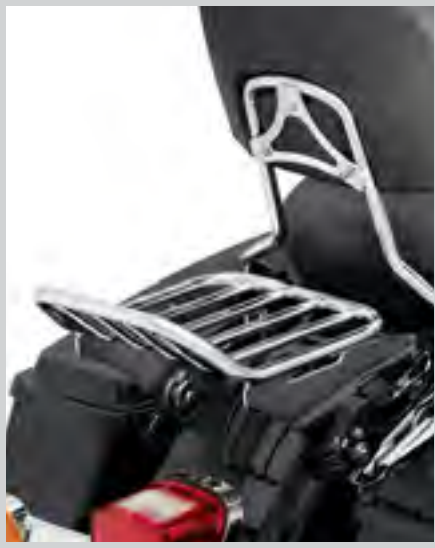

**D. H-D DETACHABLES TWO-UP LUGGAGE RACK – CHROME**

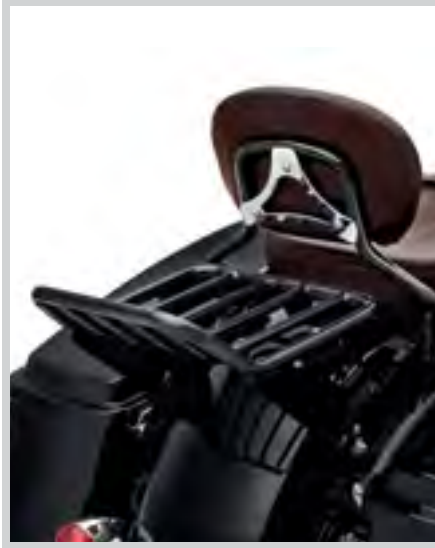

**D. H-D DETACHABLES TWO-UP LUGGAGE RACK – GLOSS BLACK**

### D. H-D® DETACHABLES™ TWO-UP LUGGAGE RACK\*

Smooth sweeping curves and a brilliant chrome finish defines the look of this Luggage Rack. Available in chrome or gloss black finish, this sleek and functional rack is an elegant solution for carrying your luggage across the country. Designed to work with or without H-D® Detachables™ Passenger Backrests, this rack can be installed or removed from the Docking Hardware in seconds, creating a truly versatile ride.

Fits '09-later Touring models equipped with 4-point Docking Hardware Kits. '09-later Touring models equipped with rigid-mount Tour-Pak® require purchase of appropriate H-D Detachables Tour-Pak Conversion Kit. FLHX, FLXS, FLTR and FLTRX models require separate purchase of Antenna Relocation Kit or Hidden Antenna Kit. Some FLHRC EU registration plates may interfere with rack.

<b>54215-09</b>	Chrome.	<b>\$219.95</b>
<b>50300042</b>	Gloss Black.	<b>\$219.95</b>

### E. LUGGAGE RACK FOR H-D DETACHABLES PASSENGER SISSY BAR UPRIGHT\*

This attractive chrome-plated rack adds additional versatility to your H-D Detachables Passenger Backrest. Designed to mount directly to the backrest upright, the rack and backrest can be easily removed or reinstalled as a unit to suit your touring or cruising style.

**53011-98** **\$209.95**

Fits '94-'08 Touring models equipped with H-D Detachables Backrests P/N 52805-97B, 52933-97B and 52723-06. (Does not fit P/N 52935-04.) FLHRC and '07-'08 FLHRSE models also require separate purchase of Saddlebag Hinge Stop Kit P/N 90580-09.



**E. LUGGAGE RACK FOR H-D DETACHABLES PASSENGER SISSY BAR UPRIGHT**



**F. H-D DETACHABLES TWO-UP LUGGAGE RACK**

### F. H-D DETACHABLES TWO-UP LUGGAGE RACK\*

Designed to work with H-D Detachables Backrests, these racks allow you to convert from a two-up traveler to a solo rider in classic style.

**53743-97** **\$209.95**

Fits '97-'08 Road King®, FLHT, FLHX and FLTR models equipped with required Docking hardware. FLTR and FLHX models require separate purchase of Antenna Relocation Kit P/N 76208-07. Does not fit with Layback License Plate Mounting Kit P/N 53385-00. Some EU registration plates may interfere with rack.

### G. H-D DETACHABLES SOLO LUGGAGE RACK\*

Add touring capabilities to your solo seat-equipped model in less than 60 seconds. This H-D Detachables Solo Rack fits over the fender when the passenger pillion is removed. The rack features sweeping curved rails and the chrome finish adds a stylish flair. Easily interchangeable with H-D Detachables Passenger Sissy Bar Upright.

**54213-09A** **\$249.95**

Fits '09-later FLHR, FLHRC, FLHT, FLHX, FLXS, FLTR, FLTRX, FLHRSE5, FLHXSE/2/3, FLTRSE3 and FLTRXSE/2 models equipped with a solo seat. Requires separate purchase of 2-Point or 4-Point Docking Hardware Kit.



**G. H-D DETACHABLES SOLO LUGGAGE RACK – ('09-LATER MODELS SHOWN)**



**H. STEALTH RIGID LUGGAGE RACK**

### H. STEALTH RIGID LUGGAGE RACK\*

Style and practicality in one. The classic four-bar luggage rack has been updated to flow with the long and lean lines of today's custom rides. The chrome-plated rails are rigid-mounted to the curving fender support and blend together for an integrated floating look and the "stealth" hidden hardware adds to the clean design.

**53938-04** **\$309.95**

Fits '06-'08 FLHX models. Also fits '99-'08 Electra Glide® Standard, Road King (except FLHRSE3/4) and Road Glide® models with separate purchase of Bullet Turn Signal Bar and License Plate Relocation Kit P/N 53702-04.



**\*WARNING:** Do not use this rack as a seat. Do not exceed the fender rack weight capacity. Using as seat or exceeding this capacity could cause handling problems which could result in loss of control and death or serious injury.

Notice: The prices appearing in this catalog are the manufacturer's suggested retail prices. Actual retail prices may vary.

## 384 TOURING & TRIKE

### Backrests & Racks

#### H-D® DETACHABLES™ TOUR-PAK® MOUNTING RACKS

Fully loaded, stripped down or anywhere in between, you can tailor your Harley-Davidson® Touring motorcycle to meet the demands of the highway. With H-D® Detachables™ docking hardware, you can transform your ride in the blink of an eye. Switch from a comfortable passenger backrest to load-hauling Tour-Pak® luggage in seconds. You can easily remove the Tour-Pak for easy maneuverability around town and reinstall it for an epic ride across the country. It's your choice and Harley-Davidson provides the flexibility to do it your way.



A. H-D DETACHABLES TWO-UP TOUR-PAK MOUNTING RACK



B. H-D DETACHABLES SOLO TOUR-PAK MOUNTING RACK



RACK INSTALLED



RACK REMOVED



**\*WARNING:** Do not use this rack as a seat. Do not exceed the fender rack weight capacity. Using as seat or exceeding this capacity could cause handling problems which could result in loss of control and death or serious injury.

*Notice: The prices appearing in this catalog are the manufacturer's suggested retail prices. Actual retail prices may vary.*



# TOURING & TRIKE 385

Backrests & Racks

NEW



**A. H-D DETACHABLES TWO-UP TOUR-PAK MOUNTING RACK – GLOSS BLACK**

NEW



## A. H-D® DETACHABLES™ TWO-UP TOUR-PAK® MOUNTING RACK\*

Change your riding style in less than 60 seconds. The ultimate in touring flexibility, this Tour-Pak® Rack makes the convenience and protection of a Razor-Pak®, Chopped, King or Leather Tour-Pak Luggage System a simple on-and-off proposition. Simple turn latches mount the rack to the bike's docking points and allow you to replace the Tour-Pak with a detachable sissy bar upright for around-town cruising. The mounting rack positions a Tour-Pak behind the passenger pillion and allows the passenger to use the luggage as a supporting backrest. Adjustable over a .75" range, the Tour-Pak can be located for maximum passenger room and comfort. Tour-Pak, Passenger Backrest Pad and Docking Hardware Kit sold separately.

Fits '14-later Road King®, Road Glide® and Street Glide® models. Requires separate purchase of Docking Hardware Kit. Street Glide and Road Glide models require Boom!™ Audio Hidden AM/FM/WB Antenna P/N 76000513 or Antenna Relocation Kit P/N 76000582.

<b>53000221</b>	Chrome.	<b>\$199.95</b>
<b>53000459</b>	Gloss Black.	<b>\$199.95</b>

Fits '09-'13 FLHR, FLHRC, FLHT, FLHX, FLTR, FLTRX, FLHRSE5, FLHXSE/2/3, FLTRSE3 and FLTRXSE/2 models. Requires separate purchase of 4-Point Docking Hardware Kit. FLHX and FLTR models require separate purchase of Tour-Pak Antenna Relocation Kit P/N 76556-09. FLHRSE5, FLHXSE/2/3, FLTRSE3 and FLTRXSE/2 models require separate purchase of Boom!™ Audio Hidden Antenna Kit P/N 76000266.

<b>53276-09A</b>	Chrome.	<b>\$194.95</b>
------------------	---------	-----------------

Fits '97-'08 Road King, FLHT, FLHX and FLTR models equipped with required docking hardware. FLTR and FLHX models require Antenna Relocation Kit P/N 76326-00A. Does not fit with Layback License Plate Mounting Kit P/N 53385-00. Some EU registration plates may interfere with Tour-Pak Rack. Models with rear fender tip trim can be adapted with the separate purchase of License Plate Relocation Kit P/N 60095-00A.

<b>53276-04</b>	Chrome.	<b>\$194.95</b>
-----------------	---------	-----------------

## B. H-D DETACHABLES SOLO TOUR-PAK® MOUNTING RACK\*

The Solo Tour-Pak Rack moves a Razor-Pak, Chopped or King Tour-Pak forward to a comfortable back-supporting position. The rack is designed to position the Tour-Pak for solo riding and is adjustable over a .75" range. Simply remove the Tour-Pak from the convenient H-D® Detachables™ docking hardware, add a passenger pillion and the bike is ready for two-up riding. Tour-Pak, Backrest Pad and Docking Hardware sold separately.

<b>53000225</b>	Chrome.	<b>\$209.95</b>
-----------------	---------	-----------------

Fits '14-later Road King, Road Glide and Street Glide models equipped with a solo seat. Requires separate purchase of Docking Hardware Kit and Boom!™ Audio Hidden AM/FM/WB Antenna P/N 76000513. Chopped Tour-Pak requires separate purchase of Tour-Pak Spacer Kit P/N 53000461. Not for use with Three-Pocket Fairing Pouch P/N 93300054 if used with Docking Kit P/N 52300131.

<b>53260-09A</b>	Chrome.	<b>\$199.95</b>
------------------	---------	-----------------

Fits '09-'13 FLHR, FLHRC, FLHT, FLHX, FLTR, FLTRX, FLHRSE5, FLHXSE/2/3, FLTRSE3 and FLTRXSE/2 models equipped with a solo seat. Requires separate purchase of 2-Point or 4-Point Docking Hardware Kit. FLHX and FLTR models require separate purchase of Tour-Pak Antenna Relocation Kit P/N 76556-09. FLHRSE5, FLHXSE/2/3, FLTRSE3 and FLTRXSE/2 models require separate purchase of Boom! Audio Hidden Antenna Kit P/N 76000266.

<b>53260-02</b>	Chrome.	<b>\$209.95</b>
-----------------	---------	-----------------

Fits '97-'08 Road King, FLHT, FLHX and FLTR models equipped with solo seat and required docking hardware.



**A. H-D DETACHABLES TWO-UP TOUR-PAK MOUNTING RACK – '14-LATER MODELS**



**A. H-D DETACHABLES TWO-UP TOUR-PAK MOUNTING RACK – '09-'13 MODELS**



**A. H-D DETACHABLES TWO-UP TOUR-PAK MOUNTING RACK – '97-'08 MODELS**



**B. H-D DETACHABLES SOLO TOUR-PAK MOUNTING RACK – '14-LATER MODELS**



**B. H-D DETACHABLES SOLO TOUR-PAK MOUNTING RACK – '09-'13 MODELS**



**B. H-D DETACHABLES SOLO TOUR-PAK MOUNTING RACK – '97-'08 MODELS**



**\*WARNING:** Do not use this rack as a seat. Do not exceed the fender rack weight capacity. Using as seat or exceeding this capacity could cause handling problems which could result in loss of control and death or serious injury.

Notice: The prices appearing in this catalog are the manufacturer's suggested retail prices. Actual retail prices may vary.

TOURING

# 386 TOURING & TRIKE

Backrests & Racks

## A. H-D® DETACHABLES™ TOUR-PAK® CONVERSION KIT <sup>1,2</sup> – '14-LATER

Transform your Electra Glide® model for around-town cruising. This kit includes everything needed to convert the rigid-mount Tour-Pak® luggage to an easy on-and-off detachable version. Complete kit includes Docking Hardware Kit, H-D® Detachables™ Two-Up Tour-Pak Mounting Rack, AM/FM Antenna Relocation Kit, License Plate Relocation Kit and Red Lens Electra Glo™ LED Saddlebag Run/Turn/Tail Lamp Kit.

**53000291** **\$569.95**

Fits '14-later FLHTCU, FLHTCUL, FLHTK, FLHTKL, FLHTKSE and FLTRUSE models. Models equipped with CB require separate purchase of CB Antenna Relocation Kit P/N 76000308. CVO™ models separate purchase of Lighting Module P/N 69200949.

**Also available:**

### CB ANTENNA RELOCATION KIT

Relocates your CB antenna to the rear fender to accommodate use with a H-D Detachables Two-Up Tour-Pak Luggage Mounting Rack. Kit includes mounting bracket, all mounting hardware and wiring harness.

**76000308** **\$69.95**

Fits '14-later FLHTCU, FLHTCUL, FLHTK, FLHTKL, FLHTKSE and FLTRUSE models equipped with Detachable Tour-Pak Conversion Kit P/N 53000291.

## B. H-D DETACHABLES TOUR-PAK CONVERSION KIT<sup>1</sup> – '97-'13

Transform your Electra Glide model for around-town cruising. This kit includes everything needed to convert the rigid-mount Tour-Pak to an easy on-and-off detachable version. Complete kit includes two-up docking hardware kit, H-D Detachables Two-Up Tour-Pak Rack, chrome license plate holder, reflector and AM/FM antenna relocation hardware.

**53246-09B** **\$549.95**

Fits '09-'13 FLHTC, FLHTCU, FLHTK and FLTRU models. FLHTCU and FLHTK require separate purchase of Wiring Harness P/N 70032-09. FLTRU models require separate purchase of Wiring Harness P/N 69200181.

**53303-07** **\$329.95**

Fits '97-'08 FLHTC models. '97-'05 models require separate purchase of Light Harness Kit P/N 70113-08.

**Also available:**

### TOUR-PAK QUICK DISCONNECT HARNESS FOR ULTRA MODELS

Wiring Harness Kit allows the installation of Detachable Tour-Pak Rack Kit on specified models.

**70032-09** **\$89.95**

Fits '09-'13 FLHTCU and FLHTK models equipped with Detachable Tour-Pak Rack Kit P/N 53246-09A.

**69200181** **\$99.95**

Fits '11-'13 FLTRU models equipped with Detachable Tour-Pak Rack Kit P/N 53246-09A.

**70113-08** **\$14.95**

Fits '97-'05 FLHTC models equipped with Detachable Tour-Pak Kit P/N 53303-07.

NEW



H-D DETACHABLES TOUR-PAK CONVERSION KIT – '14-LATER MODELS

NEW



A. H-D DETACHABLES TOUR-PAK CONVERSION KIT – '14-LATER MODELS

NEW



B. H-D DETACHABLES TOUR-PAK CONVERSION KIT – '97-'08 MODELS



**<sup>1</sup> WARNING:** Do not use this rack as a seat. Do not exceed the fender rack weight capacity. Using as seat or exceeding this capacity could cause handling problems which could result in loss of control and death or serious injury.



**<sup>2</sup> WARNING:** Disconnecting your DOT requirement brake lamp could reduce your visibility to others and result in death or serious injury.

Notice: The prices appearing in this catalog are the manufacturer's suggested retail prices. Actual retail prices may vary.

B. H-D DETACHABLES TOUR-PAK CONVERSION KIT – '09-'13 MODELS





NEW



NEW

**C. TOUR-PAK LUGGAGE AND SADDLEBAG INTERIOR LIGHT KIT – '14-LATER MODELS**

**TOURING & TRIKE 387**

Tour-Pak® Luggage

**C. TOUR-PAK® LUGGAGE AND SADDLEBAG INTERIOR LIGHT KIT**

Don't be left in the dark. This bright convenience lamp kit turns nighttime into day when you open your Tour-Pak® luggage or saddlebag. A brilliant white LED light pod mounts inside the Tour-Pak luggage to illuminate the interior and the two available LED light pods mount to the bottom of the Tour-Pak luggage to cast light inside the open saddlebags. Each LED light pod features a soft-touch micro switch for ease of activation and a 5-minute auto shutoff timer to prevent battery drain.

**3-Light Tour-Pak & Saddlebag Light Kit**

**68000151** **\$119.95**  
Fits '14-later Touring models equipped with rigid or detachable King Tour-Pak Luggage.

**54331-04A** **\$119.95**  
Fits '93-'13 Touring models equipped with rigid or detachable King or Chopped Tour-Pak Luggage.

**1-Light Tour-Pak Light Kit**

**68000152** **\$94.95**  
Fits '14-later Touring models equipped with rigid or detachable King Tour-Pak Luggage.

**54332-04A** **\$94.95**  
Fits '93-'13 Touring models equipped with rigid or detachable King or Chopped Tour-Pak Luggage.

**69200289** **\$89.95**  
Fits '09-'13 Trike models equipped with a King Tour-Pak.

**2-Light Saddlebag Light Expansion Kit**

**68000153** **\$59.95**  
Fits '14-later Touring models equipped with King Tour-Pak and Tour-Pak Interior Light Kit P/N 68000151.

**1-Light Saddlebag Light Expansion Kit**

**54333-04A** **\$38.95**  
Fits '93-'13 Touring models equipped with King or Chopped Tour-Pak Luggage and Tour-Pak Interior Light Kit P/N 54331-04A.



**C. TOUR-PAK LUGGAGE INTERIOR LIGHT KIT – '93-'13 MODELS**



**D. TRUNK INTERIOR LIGHT KIT**

Don't be left in the dark. This bright convenience lamp kit turns nighttime into day when you open your Trike's trunk. Two brilliant white LED light pods mount inside the trunk to illuminate the interior and the included contact switch turns the light on and off when you open and close the door. A 5-minute auto shut-off timer prevents battery drain. Kit includes wiring harness and installation hardware.

**83946-11** Fits '09-later FLHTCUTG models. **\$84.95**



**C. TOUR-PAK INTERIOR LIGHT KIT – TRIKE**



**D. TRUNK INTERIOR LIGHT KIT**

Notice: The prices appearing in this catalog are the manufacturer's suggested retail prices. Actual retail prices may vary.

## COLOR-MATCHED TOUR-PAK® LUGGAGE

When you're serious about racking up miles, Tour-Pak® luggage systems will help you pack for the trip. This Color-Matched hard luggage provides the capacity to pack for almost any riding condition. Carry the rain gear, clothing and camping equipment you need for a ride across the country or pack the groceries on a run to the corner store. Tour-Pak luggage is available in primed finish or Color-Matched to many factory color combinations. Solid colors, solid colors with complementing pinstripes and two-tone finishes are available to match most late-model Harley-Davidson color schemes.

Tour-Pak luggage systems are available in three capacities. The Razor-Pak is sized to carry a briefcase, laptop computer or a change of clothes, the Chopped Tour-Pak offers a low-profile shape, styled to complement a long and lean Touring bike and the King Tour-Pak is sized to provide maximum storage space.

Tour-Pak luggage can be installed on Touring models equipped with rigid or H-D® Detachables™ Tour-Pak Racks. Passenger backrest pads are available to complement Original Equipment or accessory seats.

### KING TOUR-PAK LUGGAGE – '97-'13 MODELS



#### CAPACITY 4,260 CI

Add long-haul convenience and storage capacity to your Road King®, Street Glide® or Electra Glide® Standard model. Color-Matched to the motorcycle base color, this Tour-Pak is factory drilled for wrap-around backrest (sold separately). Tour-Pak includes hinges and latches, bottom reinforcement plate, luggage box mat, map pouch and chrome side accents. King Tour-Pak can be equipped with optional wrap-around LED rear and side light kits (sold separately).

### KING TOUR-PAK LUGGAGE – '14-LATER MODELS



#### CAPACITY 4,290 CI

Turn your Touring model into a complete cross-country touring machine. The color-matched King Tour-Pak carrier features a streamlined profile that complements the sleek design of the '14-later Rushmore models. Tour-Pak is factory drilled for wrap-around backrest (sold separately) and equipped with chrome hinges, chrome one-touch latch, chrome side accents, luggage box mat and lid tether. Optional LED rear and side light kits are available.

### CHOPPED TOUR-PAK LUGGAGE – '97-'13 MODELS



#### CAPACITY 3,285 CI

Achieve a radical touring profile with this 3.0" lower Tour-Pak. The traditional Tour-Pak luggage shape has been chopped and sectioned for a sleek, sporty look, while maintaining the practical weather tight and secure storage that the long-distance rider demands. The Chopped Tour-Pak is completely assembled with factory hinges and latches and is pre-drilled for your choice of Chopped Tour-Pak backrest pads (sold separately).

### CHOPPED TOUR-PAK LUGGAGE – '14-LATER MODELS



#### CAPACITY 3,285 CI

Get ready to travel in style. The slim profile of the Chopped Tour-Pak is the perfect match for your radical custom bagger. But don't let the silhouette fool you – the Chopped Tour-Pak has loads of room to store all your gear. The Chopped Tour-Pak is factory drilled for your choice of Chopped Tour-Pak backrest pads (sold separately), and equipped with chrome hinges, chrome one-touch latch, luggage box mat and lid tether.



**KING TOUR-PAK® LUGGAGE**

See pages 806-807 for a complete list of available Color-Matched options.



**2014-LATER COLOR-MATCHED KING TOUR-PAK LUGGAGE  
(SHOWN WITH H-D DETACHABLES TWO-UP TOUR-PAK RACK AND BACKREST PAD)**



**1997-2013 COLOR-MATCHED KING TOUR-PAK LUGGAGE  
(SHOWN WITH H-D DETACHABLES TWO-UP TOUR-PAK RACK, BACKREST PAD AND SIDE LIGHT COVER)**

**Available to fit:**

Fits '14-later Road King®, Road Glide®, Street Glide® and select CVO™ models. Separate purchase of H-D® Detachables™ Two-Up or Solo Tour-Pak Mounting Rack and applicable Docking Hardware is required. Separate purchase of Tour-Pak Lock Kit P/N 90300030 is required.

Fits '09-'13 Electra Glide® Standard, Road King, Road Glide, Street Glide, Street Glide Trike and select CVO models. Separate purchase of detachable Two-Up or Solo Tour-Pak Mounting Rack and applicable Docking Hardware is required. Separate purchase of Tour-Pak Lock Kit P/N 53194-07 is required. FLHXXX models require addition of Tour-Pak Installation Kit P/N 54144-10 and Spacer Kit P/N 83294-10.

Fits '06-'08 Electra Glide Standard, Road King, Road Glide and Street Glide models. Separate purchase of detachable Two-Up or Solo Tour-Pak Mounting Rack and applicable Docking Hardware is required. Separate purchase of Tour-Pak Lock Kit P/N 53194-07 is required.

Fits '07-'05 Electra Glide Standard, Road King, and Road Glide models. Separate purchase of detachable Two-Up or Solo Tour-Pak Mounting Rack and applicable Docking Hardware is required. Separate purchase of Tour-Pak Lock Kit P/N 53194-07 is required.

## 390 TOURING & TRIKE

Tour-Pak® Luggage

### CHOPPED TOUR-PAK® LUGGAGE

See pages 806-807 for a complete list of available Color-Matched options.



**2014-LATER COLOR-MATCHED CHOPPED TOUR-PAK LUGGAGE  
(SHOWN WITH H-D DETACHABLES TWO-UP TOUR-PAK RACK AND BACKREST PAD)**



**1997-2013 COLOR-MATCHED CHOPPED TOUR-PAK LUGGAGE  
(SHOWN WITH H-D DETACHABLES TWO-UP TOUR-PAK RACK AND BACKREST PAD)**

**Available to fit:**

Fits '14-later Road King®, Road Glide®, Street Glide® and select CVO™ models. Does not fit FLRT models. Separate purchase of H-D® Detachables™ Two-Up or Solo Tour-Pak Mounting Rack and applicable Docking Hardware is required. Separate purchase of Tour-Pak Lock Kit P/N 90300030 is required.

Fits '97-'13 Touring models. FLHTCUTG models require separate purchase of Spacer Kit P/N 83294-10. FLHXXX models require addition of Tour-Pak Installation Kit P/N 54144-10 and Spacer Kit P/N 83294-10.



## RAZOR-PAK LUGGAGE

The ultimate in touring style. The slim but surprisingly roomy Razor-Pak Luggage is designed to add convenient luggage-carrying capacity without distracting from the lean look of your custom bagger. Ideal size to carry a briefcase, laptop computer or a change of clothes, the locking Razor-Pak top case can actually swallow compact half-helmets and some lightweight riding gear. So, get in a good day at the office, change your gear and hit Main Street in style. Razor-Pak Luggage can be mounted to rigid or H-D® Detachables™ Tour-Pak® mounting racks and accepts many of the lid racks, trim, spoilers and other accessories available for Chopped and King Tour-Pak Luggage.



**1997-2013 COLOR-MATCHED RAZOR-PAK LUGGAGE  
(SHOWN WITH H-D DETACHABLES TWO-UP TOUR-PAK RACK AND BACKREST PAD)**



### CAPACITY 1,900 CI

Surprisingly roomy Razor-Pak luggage is designed to add convenient luggage-carrying capacity without distracting from the lean look of your custom bagger.



**1997-2013 COLOR-MATCHED RAZOR-PAK LUGGAGE  
(SHOWN WITH H-D DETACHABLES TWO-UP TOUR-PAK RACK AND BACKREST PAD)**

Fits '97-'13 Touring models. FLHTCUTG models require addition of Spacer Kit P/N 83294-10. FLHXXX models require addition of Tour-Pak Rack Kit P/N 54144-10 and Spacer Kit P/N 83294-10.

<b>79175-10BDK</b>	Unpainted.	<b>\$699.95</b>
<b>79175-12DJO</b>	Big Blue Pearl.	<b>\$799.95</b>
<b>79175-10BYM</b>	Black Denim.	<b>\$799.95</b>
<b>79175-10BPY</b>	Black Pearl.	<b>\$799.95</b>
<b>79175-13DPU</b>	Candy Orange.	<b>\$799.95</b>
<b>79175-12DGV</b>	Chrome Yellow.	<b>\$799.95</b>
<b>79175-12DJS</b>	Ember Red Sunglo.	<b>\$799.95</b>
<b>79175-12DKJ</b>	Midnight Pearl.	<b>\$799.95</b>
<b>79175-10CYS</b>	Red Hot Sunglo.	<b>\$799.95</b>
<b>79175-10DGX</b>	Sedona Orange.	<b>\$799.95</b>
<b>79175-10DH</b>	Vivid Black.	<b>\$799.95</b>
<b>79175-10CGS</b>	White Gold Pearl.	<b>\$799.95</b>

#### Shown with:

#### **RAZOR-PAK BACKREST PAD – SMOOTH**

Clean, smooth styling complements most seating surfaces.

**79192-10** **\$139.95**

Fits '97-'13 models equipped with Razor-Pak luggage.

# 392 TOURING & TRIKE

## Tour-Pak® Luggage

### A. TOUR-PAK® LUGGAGE

Add cross-country luggage capacity to your ride with accessory Tour-Pak® Luggage. A cavernous interior will hold one full-face helmet or two half helmets. Kit includes backrest pad, interior rubber mat, hardware and instructions. Luggage capacity: 2,500 cubic inches. Dimensions: 18.5" W x 17.0" D x 13.0" H. Racks and docking kits sold separately. International models may require separate purchase of License Plate Relocation Kit P/N 60095-00A.

Fits '04-later XL models (except XL883N, XL1200C, XL1200N and XL1200T) equipped with Solo Tour-Pak Rack. Fits '00-later Softail® models (except FLS, FLSTNSE, FLSTSE/2/3 and FXCW, FXCWC, FXS, FXSB, FXSBSE, FXSTD, FXSTSSE3) equipped with H-D® Detachables™ Solo or Two-Up Tour-Pak Rack. Fits '97-'13 Touring models equipped with H-D Detachables Two-Up or Solo Tour-Pak Racks.

**53147-98C** **\$699.95**  
Road King Classic Leather Styling.

**53690-06A** **\$514.95**  
Smooth Vinyl.

**53057-07A** **\$729.95**  
CVO Road King Flamed Leather Styling. Installation requires separate purchase of Lock Set P/N 54360-05.



**A. ROAD KING CLASSIC LEATHER TOUR-PAK LUGGAGE**

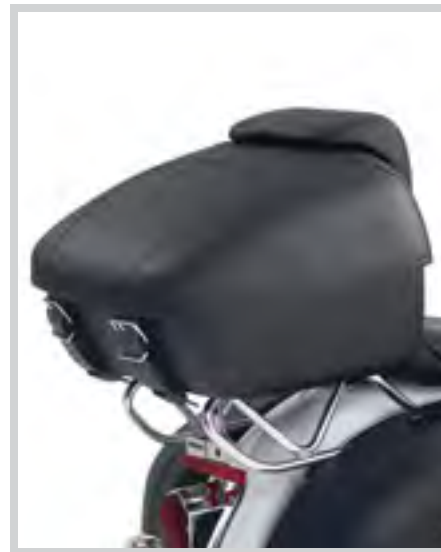

**A. SMOOTH VINYL TOUR-PAK LUGGAGE**

### B. LEATHER TOUR-PAK LOCK SET

Designed to discourage grab-and-run theft, this Lock Set provides a level of security that leather straps alone can't match. The complete kit includes external locking push-button latch release, locking mechanism, release cable, two keys, steel Tour-Pak lid mounting plate and all required installation hardware. Special order keyed-to-match lock sets are available for models with barrel-type keys. Contact your Dealer with your vehicle key code.

**54360-05** **\$199.95**  
Fits models equipped with Leather or Synthetic Leather Tour-Pak Luggage (except P/N 79189-06).



**A. CVO ROAD KING FLAMED LEATHER TOUR-PAK LUGGAGE**



**B. LEATHER TOUR-PAK LOCK SET**

### C. PREMIUM LEATHER TOUR-PAK LUGGAGE

This king-sized Tour-Pak will provide all the storage capacity you need for a trip across the country. This smooth leather-wrapped luggage is highlighted with an embossed ostrich pattern insert, leather braiding and custom stitching and features a raised center section to accommodate most full-face helmets. Tour-Pak includes Chrome Luggage Rack, Chrome Accent Spears and Interior Light. Kit does not include Tour-Pak mounting rack, hardware or instructions to relocate an antenna on models equipped with a radio or CB.

**79189-06** **\$1,499.95**  
Fits '97-'08 Road King®, Road Glide®, Electra Glide® Standard and Street Glide® models equipped with Tour-Pak Rack and appropriate Docking Hardware Kits. Road Glide and Street Glide models require separate purchase of Antenna Relocation Kit P/N 76326-00A. All models require separate purchase of Tour-Pak Installation Kit P/N 90067-06, Keyed-to-Match Tour-Pak Lock P/N 53865-06A, Lock Clip P/N 53868-06 and Fitted Tour-Pak Liners P/N 91814-06 and 53230-06. International models may require separate purchase of License Plate Relocation Kit P/N 60095-00A.

#### Shown with:

#### TOUR-PAK INSTALLATION KIT

Kit includes wrap-around passenger backrest pad and required Tour-Pak installation hardware. Does not include Tour-Pak mounting rack.

**90067-06** **\$399.95**  
Required for installation of Premium Leather Tour-Pak Luggage P/N 79189-06 on '97-'08 Road King, Road Glide, Electra Glide Standard and Street Glide models.



**C. PREMIUM LEATHER TOUR-PAK LUGGAGE (SHOWN WITH TOUR-PAK INSTALLATION KIT)**

*Notice: The prices appearing in this catalog are the manufacturer's suggested retail prices. Actual retail prices may vary.*



# TOURING & TRIKE 393

Tour-Pak® Luggage

## CHOPPED TOUR-PAK® BACKREST PADS

Chopped Tour-Pak® Backrest Pads provide deep padded support for your passenger and a low-profile shape that complements the low, lean look of your Tour-Pak. Easy to install, the floating design of the integrated mounts reduce the contact between the pad and the Tour-Pak to minimize paint scuffing. Chopped Backrest Pads are available in a wide variety of styles to match most seating surfaces.

### D. CHOPPED TOUR-PAK BACKREST PAD – SMOOTH

Clean, smooth styling complements most seating surfaces.

**52300319** **\$169.95**

Fits '14-later Touring and Tri Glide® models equipped with Chopped Tour-Pak luggage.

**52898-98A** **\$169.95**

Fits '97-'13 Touring models equipped with Chopped Tour-Pak luggage.

### E. CHOPPED TOUR-PAK BACKREST PAD – CVO™ STREET GLIDE STYLING

Matches '15 CVO™ Street Glide® Original Equipment seat.

**52300359** **\$199.95**

Fits '14-later Touring and Tri Glide models equipped with Chopped Tour-Pak luggage.

### F. CHOPPED TOUR-PAK BACKREST PAD – CVO ROAD KING STYLING

Matches '14 CVO™ Road King® Original Equipment seat with leather tuck and roll inlay.

**52300335** **\$209.95**

Fits '14-later Touring and Tri Glide models equipped with Chopped Tour-Pak luggage.

### G. CHOPPED TOUR-PAK BACKREST PAD – CVO ROAD GLIDE® CUSTOM STYLING

Matches '13 CVO Road Glide® Custom Original Equipment seat. (except the 110th Anniversary edition CVO FLTRXSE2).

**52300298** **\$209.95**

Fits '97-'13 Touring models equipped with Chopped Tour-Pak luggage.

### H. CHOPPED TOUR-PAK BACKREST PAD – '06-'10 STREET GLIDE STYLING

Styled to match the '06-'10 Street Glide® Original Equipment or Sundowner™ seat.

**51635-06** **\$199.95**

Fits '97-'13 Touring models equipped with Chopped Tour-Pak luggage.

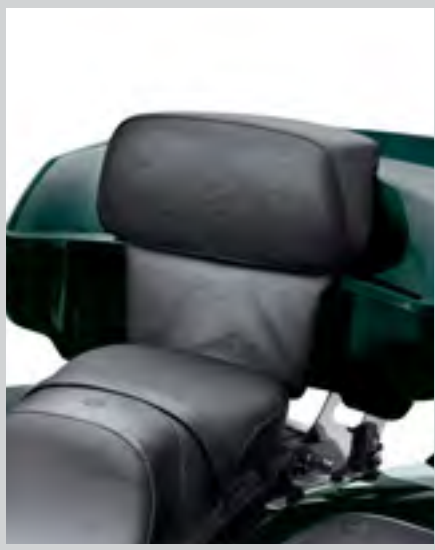

D. CHOPPED TOUR-PAK BACKREST PAD – SMOOTH  
'14-LATER MODELS



D. CHOPPED TOUR-PAK BACKREST PAD – SMOOTH  
'97-'13 MODELS

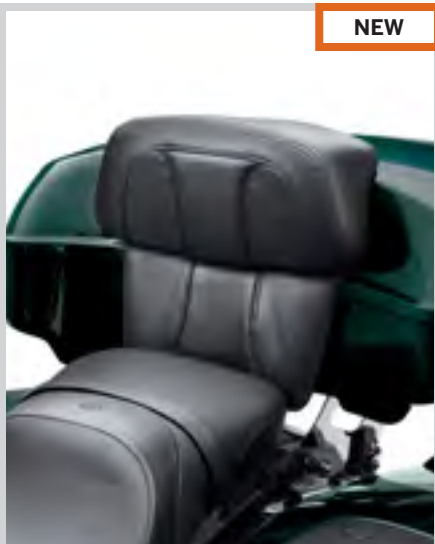

E. CHOPPED TOUR-PAK BACKREST PAD – '15 CVO STREET GLIDE STYLING

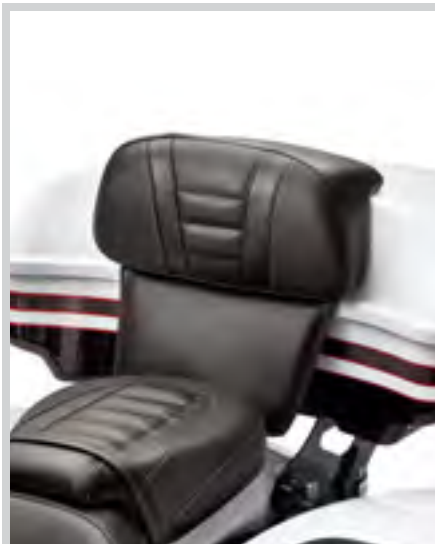

F. CHOPPED TOUR-PAK BACKREST PAD – '14 CVO ROAD KING STYLING



G. CHOPPED TOUR-PAK BACKREST PAD – '13 CVO ROAD GLIDE CUSTOM STYLING

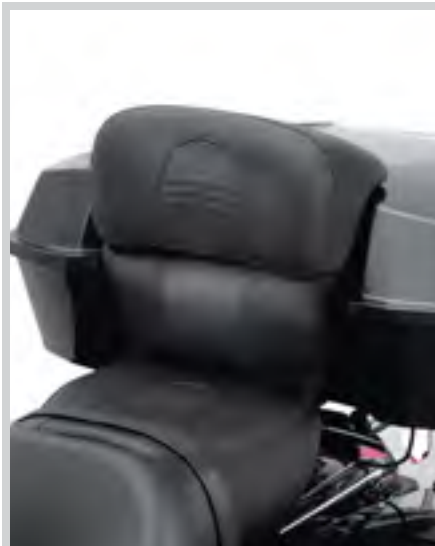

H. CHOPPED TOUR-PAK BACKREST PAD – '06-'10 STREET GLIDE STYLING

Notice: The prices appearing in this catalog are the manufacturer's suggested retail prices. Actual retail prices may vary.

# 394 TOURING & TRIKE

Tour-Pak® Accessories

## A. SUN RAY® HEATED KING TOUR-PAK® BACKREST PAD

Take the chill out of cool spring days and brisk fall nights with a heated wrap-around backrest pad. The Sun Ray® Pad features a convenient high/low/off toggle control that directs two levels of soothing warmth right where you need it. This one-piece pad with integrated heat element and thermostatic control system is simple to install and the heating element is switched off with the ignition to avoid draining the battery. Available in Smooth or Comfort Stitch styles, this pad can be teamed with a Sun Ray or Harley® Hammock Heated Seat for the ultimate in back and bottom comfort.

Fits '14-later Touring and Tri Glide® models equipped with King Tour-Pak® luggage.

**52300317** Comfort Stitch. **\$349.95**

Fits '97-'13 Touring and Trike models equipped with King Tour-Pak. Models not equipped with separate Tour-Pak backrest lower pad require separate purchase of Tour-Pak Lower Backrest Pad P/N 52400020.

**54387-11** Comfort Stitch. **\$349.95**

**Shown with:**

### TOUR-PAK LOWER BACKREST PAD

One-piece pad provides lower back comfort and protects the Tour-Pak box from scuffs and scratches. Black vinyl surface complements most leather and vinyl seats and King Tour-Pak backrests. Kit includes pad and all necessary installation hardware.

**52400020** **\$39.95**

Fits '97-'13 Touring and Trike models equipped with King Tour-Pak luggage.

### KING TOUR-PAK BACKREST PADS

Wrap-Around King Tour-Pak Backrest Pads are shaped to surround your passenger in comfort. The curved shape cradles the back and the integrated side wings fit naturally beneath your passenger's arms for added support. These backrests feature easy-to-install isolation mounts to reduce contact between the pad and the Tour-Pak. King Backrest Pads are available in a variety of styles to match most seating surfaces.

## B. KING TOUR-PAK BACKREST PAD – COMFORT STITCH

Styled to match the Comfort Stitch Touring Seat series.

**52300314** **\$229.95**

Fits '14-later Touring and Tri Glide models equipped with King Tour-Pak luggage.

**52395-03B** **\$229.95**

Fits '97-'13 Touring and Trike models equipped with King Tour-Pak luggage.

## C. KING TOUR-PAK BACKREST PAD – SMOOTH

Clean, smooth styling complements most seating surfaces.

**52300312** **\$219.95**

Fits '14-later Touring and Tri Glide models equipped with King Tour-Pak luggage.

**52892-98B** **\$219.95**

Fits '97-'13 Touring and Trike models equipped with King Tour-Pak luggage.



**A. SUN RAY HEATED KING TOUR-PAK BACKREST PAD – COMFORT STITCH '14-LATER MODELS**



**A. SUN RAY HEATED KING TOUR-PAK BACKREST PAD – COMFORT STITCH '97-'13 MODELS**



**B. KING TOUR-PAK BACKREST PAD – COMFORT STITCH '14-LATER MODELS**

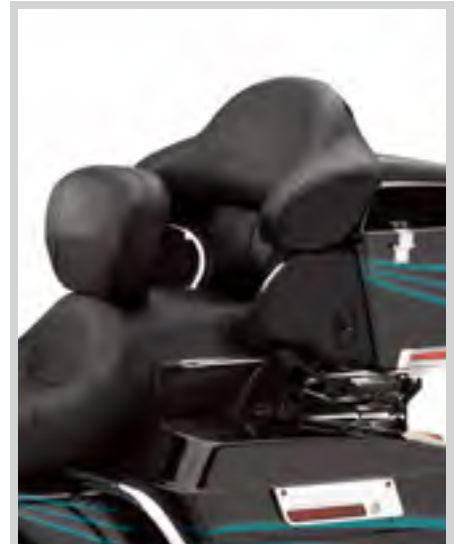

**B. KING TOUR-PAK BACKREST PAD – COMFORT STITCH '97-'13 MODELS**



**C. KING TOUR-PAK BACKREST PAD – SMOOTH '14-LATER MODELS**

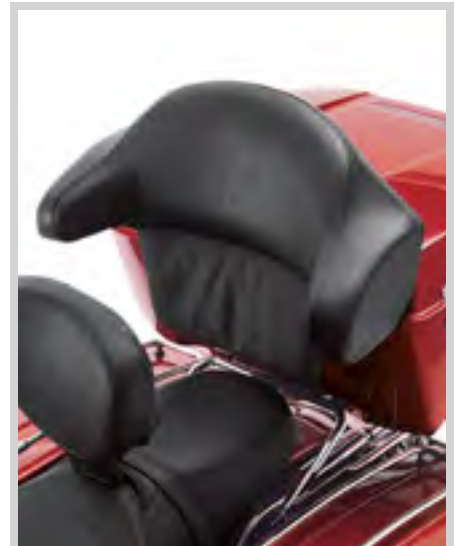

**C. KING TOUR-PAK BACKREST PAD – SMOOTH '97-'13 MODELS**

*Notice: The prices appearing in this catalog are the manufacturer's suggested retail prices. Actual retail prices may vary.*



# TOURING & TRIKE 395

Tour-Pak® Accessories

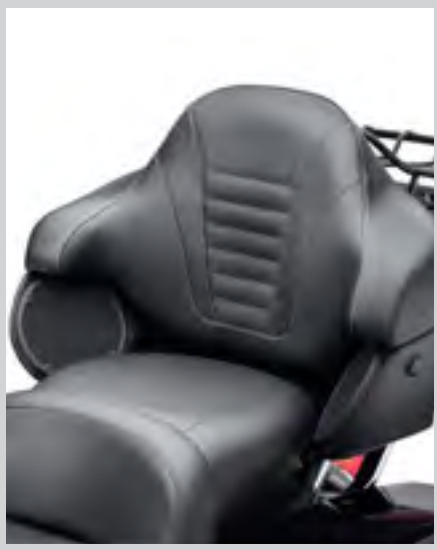

**D. KING TOUR-PAK BACKREST PAD – '14 CVO ROAD KING STYLING**



**E. KING TOUR-PAK BACKREST PAD – '13 CVO ROAD GLIDE CUSTOM STYLING**



**F. KING TOUR-PAK BACKREST PAD – '15 CVO STREET GLIDE STYLING**



**G. KING TOUR-PAK BACKREST PAD – LEATHER ROAD ZEPPELIN**

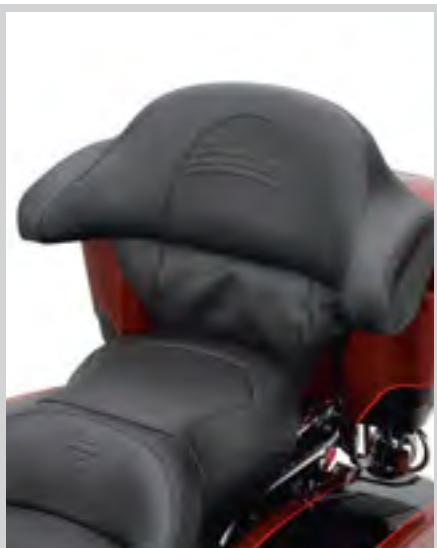

**H. KING TOUR-PAK BACKREST PAD – '06-'10 STREET GLIDE STYLING**



**I. KING TOUR-PAK BACKREST PAD – ROAD KING STYLING**

**D. KING TOUR-PAK BACKREST PAD – CVO™ ROAD KING® STYLING**

Matches '14 CVO™ Road King® Original Equipment seat.

**52300334** **\$299.95**

Fits '14-later Touring and Tri Glide® models equipped with King Tour-Pak® luggage.

**E. KING TOUR-PAK BACKREST PAD – CVO ROAD GLIDE CUSTOM STYLING**

Matches '13 CVO Road Glide® Original Equipment seat (except the 110th Anniversary edition CVO FLTRXSE2).

**52300295** **\$299.95**

Fits '97-'13 Touring and Trike models equipped with King Tour-Pak luggage.

**F. KING TOUR-PAK BACKREST PAD – CVO STREET GLIDE STYLING**

Matches '15 CVO Street Glide® Original Equipment seat.

**52300360** **\$299.95**

Fits '14-later Touring and Tri Glide models equipped with King Tour-Pak luggage.

**G. KING TOUR-PAK BACKREST PAD – LEATHER ROAD ZEPPELIN®**

Styled to match the tufted leather Road Zeppelin® seat.

**52335-97A** **\$299.95**

Fits '97-'13 Touring and Trike models equipped with King Tour-Pak luggage.

**H. KING TOUR-PAK BACKREST PAD – '06-'10 STREET GLIDE STYLING**

Styled to match the '06-'10 Street Glide Original Equipment or Sundowner™ seat.

**51634-06A** **\$239.95**

Fits '97-'13 Touring and Trike models equipped with King Tour-Pak luggage.

**I. KING TOUR-PAK BACKREST PAD – ROAD KING STYLING**

Embroidered "Road King" logo and smooth look matches your stock FLHR seat.

**52274-94B** **\$229.95**

Fits '94-'13 Touring and Trike models equipped with King Tour-Pak luggage.

# 396 TOURING & TRIKE

Tour-Pak® Accessories

## A. AIR WING TOUR-PAK® LUGGAGE RACK\*

The low-profile aerodynamic styling of the Air Wing Tour-Pak® Luggage Rack enhances the look of any Razor-Pak, Chopped or King Tour-Pak lid. Available in mirror-chrome or rich gloss black finish, the rack draws your eye with its sleek lines and the engraved Harley-Davidson script adds a signature touch. This full-sized rack protects both Tour-Pak lid and passenger backrest from scratches. The die-cast wing and lightweight steel tubing are hand-polished before finishing for long-lasting beauty. Kit includes all necessary mounting hardware. For added visibility, the rack is designed to incorporate the internal wiring of the Air Wing Rack Light Kit P/N 68271-08 or 68250-08 (sold separately) for a clean look.

Fits King, Chopped and Razor-Pak Tour-Pak lids. Mounting hole pattern matches Premium Tour-Pak Luggage Rack P/N 53665-87.

<b>79179-08</b>	Chrome.	<b>\$199.95</b>
<b>5300063</b>	Gloss Black.	<b>\$199.95</b>



**A. AIR WING TOUR-PAK LUGGAGE RACK – CHROME**



**A. AIR WING TOUR-PAK LUGGAGE RACK – GLOSS BLACK**

## B. AIR WING RACK LED LIGHT KIT

Custom fit to the Air Wing Tour-Pak Rack, this fast-acting LED Light Kit operates as a supplemental rear running light and brake light. The high, center-mount position places the rear light in the line-of-sight of following vehicles and the bright, fast-acting LED lamps get you noticed. Wiring is concealed inside the rack tubes for a clean, custom installation.

Fits '14-later Touring and Trike models equipped with Air Wing Tour-Pak Luggage Rack P/N 79179-08 or 53000063. Also fits '14-later FLHTKSE and '15-later FLTRUSE models with Original Equipment Tour-Pak Rack.

<b>68000112</b>	Red Lens.	<b>\$69.95</b>
<b>68000113</b>	Smoked Lens.	<b>\$69.95</b>

Fits '97-'13 Touring models equipped with the Air Wing Tour-Pak Luggage Rack P/N 79179-08 or 53000063. Also fits FLHTCUSE4/5/6/7/8 models with Original Equipment Tour-Pak Rack.

<b>68271-08A</b>	Smoked Lens.	<b>\$69.95</b>
<b>68250-08A</b>	Red Lens.	<b>\$69.95</b>



**B. AIR WING RACK LED LIGHT KIT – SMOKED LENS**



**C. PREMIUM TOUR-PAK LUGGAGE RACK**

## C. PREMIUM TOUR-PAK LUGGAGE RACK\*

This full-sized rack is especially designed to complement Tour-Pak lids with armrest-style passenger backrests. Protects both Tour-Pak lid and passenger backrest from scratches. Lightweight steel tubing incorporates high-quality welded joints and is hand-polished and chrome-plated using copper as a base coat followed by nickel and chrome to provide long-lasting beauty. Comes complete with all necessary mounting hardware.

<b>53665-87</b>		<b>\$129.95</b>
-----------------	--	-----------------

Fits King, Chopped and Razor-Pak Tour-Pak lids.



## D. STEALTH TOUR-PAK LUGGAGE RACK\*

Style and practicality in one. This classic six-bar Tour-Pak luggage rack flows with the long and lean lines of today's custom rides. The cantilevered aerodynamic rails appear to float above the center spar, imparting a lighter-than-air profile. Hidden hardware adds to the clean design. The Stealth Rack mounts in the same position as the Original Equipment Ultra Limited rack or the accessory Premium and Air Wing Tour-Pak luggage racks, so no additional drilling is required on those models. Use Bungee Cord Soft-Hook Extensions P/N 52300140 to keep your luggage firmly in place.

Fits King, Chopped and Razor-Pak Tour-Pak lids. Does not fit with Color-Matched Tour-Pak Spoiler kits.

<b>53000242</b>	Chrome.	<b>\$239.95</b>
<b>53000247</b>	Gloss Black.	<b>\$239.95</b>



**D. STEALTH TOUR-PAK LUGGAGE RACK – CHROME**



**D. STEALTH TOUR-PAK LUGGAGE RACK – GLOSS BLACK**



**\*WARNING:** Do not use this rack as a seat. Do not exceed the fender rack weight capacity. Using as seat or exceeding this capacity could cause handling problems which could result in loss of control and death or serious injury.

*Notice: The prices appearing in this catalog are the manufacturer's suggested retail prices. Actual retail prices may vary.*



## TOURING & TRIKE 397

Tour-Pak® Accessories



**E. TOUR-PAK ACCENT RAIL – CHROME  
'14-LATER MODELS**

### **E. TOUR-PAK® ACCENT RAIL – CHROME**

Fabricated from highly polished steel tubing, these premium quality chrome-plated Accent Rails frame the wrap-around Tour-Pak® lights for a custom look. The rails provide an added level of protection from pass-by contact. Kit includes all necessary mounting hardware.

**53000229** **\$129.95**

Fits '14-later FLHTCU, FLHTCUL, FLHTK, FLHTKL, FLHTCUTG and models equipped with accessory King Tour-Pak and LED Wrap-Around Light. Does not fit CVO™ FLHTKSE or FLTRUSE models.

**53667-89A** **\$109.95**

Fits '13-earlier Ultra Classic® models (except FLHTCUSE5/6/7/8) and any King Tour-Pak equipped with King Tour-Pak Brake/Tail Lamp Kit P/N 68012-88E.

### **F. TOUR-PAK REAR LIGHT TRIM**

Add a custom touch to the Original Equipment Tour-Pak rear lighting. This mirror-chrome trim covers the satin black surface and adds a brilliant finishing touch to the rear of the bike. Self-adhesive mounting simplifies installation.

**53000329** **\$79.95**

Fits '14-later FLHTCU, FLHTCUL, FLHTK, FLHTKL, FLHTCUTG and models equipped with accessory King Tour-Pak and LED wrap-around tail lamp.

### **G. ULTRA TOUR-PAK BRAKE LIGHT ACCENT COVERS – CHROME**

Kit includes a pair of triple chrome-plated steel brake lamp accents and a complementing chrome center trim piece that wraps any Ultra King Tour-Pak luggage.

**59239-93** **\$104.95**

Fits '89-'13 FLHTCU and FLHTCUTG models and other Touring models equipped with King Tour-Pak and Ultra Classic Brake Lamp Kit P/N 68012-88E. (Does not fit '10-'13 FLHTCUSE.)



**E. TOUR-PAK ACCENT RAIL – CHROME  
'13-EARLIER MODELS**



**F. TOUR-PAK REAR LIGHT TRIM**



**G. ULTRA TOUR-PAK BRAKE LIGHT ACCENT COVERS – CHROME**

Notice: The prices appearing in this catalog are the manufacturer's suggested retail prices. Actual retail prices may vary.

# 398 TOURING & TRIKE

Tour-Pak® Accessories

## A. LED KING TOUR-PAK® BRAKE/TURN/TAIL LAMP KIT – SMOKED

Add a sinister touch to the rear of your bike. This smoked LED lamp kit is a direct plug-in replacement for the stock LED red lens wrap-around Tour-Pak® light. The bright fast-acting LEDs glow bright red when activated, but nearly disappear behind the dark smoke lens when off. The lamp features a flat black surround that complements any solid or two-tone paint color and accommodates single and dual-antenna applications. No cutting or splicing is required for installation.

**67800368** Smoked Lens. **\$299.95**  
Fits '14-later FLHTCU, FLHTCUL, FLHTK, FLHTKL and FLHTCUTG models.



A. LED KING TOUR-PAK BRAKE/TURN/TAIL LAMP KIT – SMOKED

## B. LED KING TOUR-PAK BRAKE/TURN/TAIL LAMP KIT

Add high-mount turn signals, running and brake lamps to your Classic and Ultra King Tour-Pak. This wrap-around light kit is equipped with bright, fast-acting LED lamps that grab the attention of following traffic. The corner lights operate in run/brake/turn mode and the center lamp functions as a run and brake lamp. The slim-line design mounts to the exterior surface of the Tour-Pak and can be used to replace the Original Equipment Ultra-style lamp. When equipped with Tour-Pak Liner P/N 53302-07 (sold separately), this kit eliminates the interior bulges and maximizes the carrying capacity inside. Available with smoked or red lens, the lamp features a flat black surround that complements any solid or two-tone paint color. Kit accommodates single and dual-antenna applications. No cutting or splicing is required for installation and kit includes a simple drilling template, interior mounting plates, mounting hardware and wiring harness.

Fits '97-'13 Touring models (except CVO™) equipped with King Tour-Pak luggage.

**67931-11** Smoked Lens. **\$499.95**  
**67932-11** Red Lens. **\$499.95**



B. LED KING TOUR-PAK BRAKE/TURN/TAIL LAMP KIT – RED LENS

## C. KING TOUR-PAK BRAKE/TAIL LAMP KIT

Dual filament bulbs provide both brake and tail lamp. Meets DOT requirements. Includes template to assist in cutting out lens housing openings, step-by-step instructions, wiring and all necessary mounting hardware. Dealer installation recommended.

**68172-06** **\$239.95**  
Fits '97-'13 FLHTCU, FLHTK, FLTRU, FLHTCUTG and other models equipped with Ultra-style Tour-Pak. (Does not fit '10-'13 FLHTCUSE.)

**68012-88E** **\$239.95**  
Fits '88-'05 King Tour-Pak. (NOTE: Kit accommodates single antenna applications.)

NOTE: Original Equipment on Ultra Classic® Models.



B. LED KING TOUR-PAK BRAKE/TURN/TAIL LAMP KIT – SMOKED LENS



C. KING TOUR-PAK BRAKE/TAIL LAMP KIT

Notice: The prices appearing in this catalog are the manufacturer's suggested retail prices. Actual retail prices may vary.



NEW

# TOURING & TRIKE 399

Tour-Pak® Accessories



**D. TOUR-PAK SIDE MARKER LIGHT TRIM**

**D. TOUR-PAK® SIDE MARKER LIGHT TRIM**

Add a custom touch to the Original Equipment Tour-Pak® side lighting. Mirror-chrome trim surrounds the side marker lights for a bit of flash and the self-adhesive backing simplifies installation. Kit includes left and right side trim.

**53000330** **\$79.95**

Fits '14-later Electra Glide® and Tri Glide® models with Original Equipment King Tour-Pak-mounted side lights. Also fits '14-later models equipped with accessory King Tour-Pak and Side Marker Light Kits P/N 54352-09 or 69494-06.

**E. TOUR-PAK SIDE MARKER LIGHT KIT**

This wrap-around Side Marker Light Kit adds a splash of light to the lower edge of the Tour-Pak Luggage System. Kit replaces the chrome side trim along the lower edge of the Tour-Pak on Electra Glide Classic models or replaces the Original Equipment red lens featured on Ultra Classic® Electra Glide and Tri Glide models. Available in your choice of red or smoked lens. The smoked lens remains stealthy while the ignition is off, but glows red when the lights are switched on. Complete kit includes left and right lens housings, wiring harness and all required installation hardware.

**54352-09** Smoked Lens. **\$119.95**

Fits '06-later Touring and Trike models equipped with King Tour-Pak luggage.

**69494-06** Red Lens. **\$119.95**

Fits '06-later Touring and Trike models equipped with King Tour-Pak luggage. Original Equipment on the '06-later FLHTCU, FLHTCUL, FLHTK, FLHTKL and FLHTCUTG models.

**F. TOUR-PAK SIDE LIGHT ACCENT COVERS – CHROME**

Formed of triple chrome-plated steel, these easy-to-install accent covers add a touch of flash to your Tour-Pak side marker lights. Sold in pairs.

**59349-97** Fits '97-'05 King Tour-Pak Luggage. **\$69.95**



**E. TOUR-PAK SIDE MARKER LIGHT KIT – SMOKED (ON)**



**E. TOUR-PAK SIDE MARKER LIGHT KIT – RED**

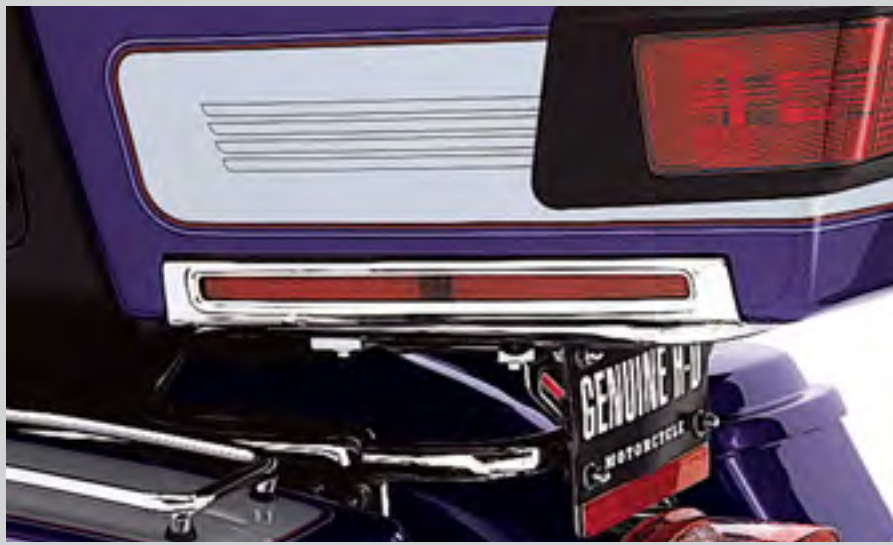

**F. TOUR-PAK SIDE LIGHT ACCENT COVERS – CHROME**

TOURING

*Notice: The prices appearing in this catalog are the manufacturer's suggested retail prices. Actual retail prices may vary.*

# 400 TOURING & TRIKE

Tour-Pak® Accessories

## A. TOUR-PAK® HINGE AND LATCH KIT – GLOSS BLACK

Upgrade the appearance of your Tour-Pak® luggage. These Original Equipment-style hinges and latch are polished and finished in rich gloss black. The complete kit includes hinges, latch and all necessary hardware.

**53000343** \$199.95

Fits '14-later Touring and Tri Glide® models equipped with Chopped or King Tour-Pak Luggage.



A. TOUR-PAK HINGE AND LATCH KIT – GLOSS BLACK

## B. PREMIUM TOUR-PAK HINGES

Upgrade the appearance of your Tour-Pak with billet-style premium hinges. Styled to complement the Original Equipment Tour-Pak latches, these hinges add a clean, bold look with no exposed hardware. Available in mirror-chrome or gloss black finish, the complete kit includes two hinges and all necessary hardware. Drill is required to remove the factory installed hinge mounting rivets.

Fits '88-'13 Touring and Trike models equipped with Razor-Pak, Chopped or King Tour Pak luggage.

**79211-08A** Chrome. \$52.95

**53000131** Gloss Black. \$52.95



B. PREMIUM TOUR-PAK HINGES – CHROME

B. PREMIUM TOUR-PAK HINGES – GLOSS BLACK

## C. PREMIUM TOUR-PAK LATCHES

Styled to complement the Premium Tour-Pak Hinges, these die-cast latches provide a bold look to your ride. Designed to eliminate the traditional catch and clamp design, these latches make access to the Tour-Pak luggage easier than ever. Simply press down on the top of the lid to secure the latching mechanism. The self-aligning design positions the lid perfectly for no-fuss closure. A simple push of the button releases the lock and pops the lid open for convenience. Latches feature hidden hardware for a clean appearance and the front latch wraps around the Original Equipment lock for a custom touch. Kit includes front and rear latch and all mounting hardware.

Fits '06-'13 Touring and Trike models equipped with King or Ultra Tour-Pak Luggage. Does not fit with Leather, Razor-Pak or Chopped Tour-Pak Luggage. Does not fit models equipped with Tour-Pak Lock Covers P/N 53000217 or 53000218.

**53000252** Chrome. \$109.95

**53000253** Gloss Black. \$99.95



C. PREMIUM TOUR-PAK LATCHES – CHROME

C. PREMIUM TOUR-PAK LATCHES – GLOSS BLACK

## D. TOUR-PAK LOCK COVER

This elegant die-cast cover with a Bar & Shield logo adds a custom touch to your Tour-Pak lock. Simply use your thumb to rotate the domed cover to expose the Original Equipment lock. A detent holds the cover in the open position and provides unhindered access for your key. Easy to install, the protective cover is held firmly in place by the Original Equipment lock and lock mounting hardware.

Fits '88-'13 Touring and Trike models equipped with King, Razor-Pak or Chopped Tour-Pak Luggage. Does not fit with Premium Tour-Pak Latches P/N 53000252 or 53000253.

**53000217** Chrome. \$32.95

**53000218** Gloss Black. \$32.95



D. TOUR-PAK LOCK COVER – CHROME

D. TOUR-PAK LOCK COVER – GLOSS BLACK

Notice: The prices appearing in this catalog are the manufacturer's suggested retail prices. Actual retail prices may vary.



# TOURING & TRIKE 401

Tour-Pak® Accessories



**E. TOUR-PAK LATCHES – GLOSS BLACK**

## **E. TOUR-PAK® LATCHES – GLOSS BLACK**

Add a custom touch to your Tour-Pak® luggage. Styled to complement available gloss black Premium Tour-Pak Hinges, these Original Equipment-style latches are polished and finished in rich gloss black. The complete kit includes latches, hasps and all necessary hardware.

**53000130** **\$39.95**  
Fits '88-'13 Touring and Trike models equipped with Razor-Pak, Chopped or King Tour-Pak Luggage.

## **F. EZ TOUR-PAK LID CATCH**

Add the convenience of a self-aligning Tour-Pak lid to your Touring bike. Simply close the lid and latch it down. This easy-to-install kit eliminates the need to shift the position of the lid because the latches line up perfectly every time.

**53000195** **\$14.95**  
Fits '85-'13 Touring and Trike models equipped with King, Ultra or Razor-Pak Tour-Pak Luggage. Does not fit Chopped, Leather or Sport Tour-Pak Luggage.



**F. EZ TOUR-PAK LID CATCH**

## **G. TOUR-PAK SPEAR TRIM KIT – CHROME**

These die-cast and chrome-plated trim spears add a sweeping slash of chrome to the Tour-Pak lid. These easy-to-install self-adhesive spears can also be used to cover the mounting holes when removing Tour-Pak Lid Rack P/N 53665-87 or 53101-96.

**53887-05** **\$43.95**  
Fits '93-'13 Touring and Trike models with King, Chopped or Razor-Pak Tour-Pak Luggage.

## **H. TOUR-PAK LID ACCENT PANEL – CHROME AND SIMULATED LEATHER**

Chrome and leather are the classic materials to dress your Harley® motorcycle. And this Chrome and Simulated Leather Accent Panel is just the thing for customizing your Tour-Pak. The mirror-finish heavy chrome trim band with "Harley-Davidson" logo surrounds a field of black vinyl that fits the recess on your Tour-Pak lid. Includes installation hardware.

**53911-01** **\$64.95**  
Fits '93-'05 Touring models equipped with King or Chopped Tour-Pak. (Does not fit with Mini Tour-Pak Lid Rack P/N 53100-96.) Will not fit with previously installed Tour-Pak Lid Organizer P/N 53249-01A.



**G. TOUR-PAK SPEAR TRIM KIT – CHROME**



**H. TOUR-PAK LID ACCENT PANEL – CHROME AND SIMULATED LEATHER**

## **I. RETRACTABLE TOUR-PAK LID TETHER**

Add the convenience of a Retractable Tether to your Tour-Pak. When extended to its full length, the strong cord holds the lid open at least 10° past vertical for improved stability and easy packing. Then the device automatically coils the tether cord inside the housing to eliminate pinched cords when closing the lid. The attractive housing with Bar & Shield logo attaches to the existing mounting points and replaces the Original Equipment cord.

**54171-11** **\$31.95**  
Fits '13-earlier Touring and Trike models equipped with a King, Ultra, Chopped or Razor-Pak Tour-Pak Luggage. Will not fit Leather or Sport Tour-Pak Luggage.

## **J. RETRACTABLE TRUNK DOOR TETHER**

Add the convenience of a Retractable Tether to your Trike trunk door. The tethers easily mount to your trunk door and replace the stock support cords. When you open the trunk door, the tether smoothly deploys from the housing to support the door in the full open position. Then as you close the door, the device automatically coils the tether cord inside the housing to eliminate pinched cords. The attractive housing with Bar & Shield logo attaches to the existing mounting points. Sold in pairs.

**53000237** **\$54.95**  
Fits '11-later Tri Glide® models.



**I. RETRACTABLE TOUR-PAK LID TETHER**



**J. RETRACTABLE TRUNK DOOR TETHER**

*Notice: The prices appearing in this catalog are the manufacturer's suggested retail prices. Actual retail prices may vary.*

# 402 TOURING & TRIKE

## Saddlebag Accessories

### A. COLOR-MATCHED SADDLEBAG LID SPOILER KIT\*

Aero styling and a practical addition to rear visibility. Color-matched Saddlebag Lid Spoilers equipped with bright fast acting LED lamps that will get you noticed.

#### '14-later Models

Designed for easy installation, these Saddlebag Lid Spoilers feature your choice of Red- or Smoked-lens LED lamps (sold separately) that function as auxiliary running, brake and turn signals.

Fits '14-later Touring models with hard saddlebags and Saddlebag Lid Spoiler Light Kit P/N 90200735 or 90200736.

#### '93-'13 Models

Saddlebag Lid Spoilers include integrated bright red LED auxiliary running/brake lights that are a simple plug-in installation on '97-'13 models.

Fits '93-'13 Touring models with Color-Matched Hard Saddlebags.

#### Also available:

##### LED LIGHT KIT – SADDLEBAG SPOILERS

Custom fit to Saddlebag Lid Spoilers, these fast-acting LED Light Kits operate as a supplemental rear running light, brake light and turn signals. The bright, fast-acting red LED lamps get you noticed and the mounting position places the light above the traditional rear fender-mounted lamps and closer to the line-of-sight of following vehicles. Wiring is concealed for a clean, custom installation. Available with red or smoked lens.

Fits '14-later Touring models equipped with Saddlebag Spoiler Kit (sold in pairs).

**90200735** Red Lens. **\$99.95**

**90200736** Smoked Lens. **\$99.95**

### B. COLOR-MATCHED TOUR-PAK® SPOILER KIT\*

The combination of contoured styling and the practicality of an integrated auxiliary LED running/brake light blend form and function into the Tour-Pak® Spoiler.

#### '14-later Models

Designed for easy installation, the Tour-Pak Spoiler features a high-mounted LED running and brake light that gets you noticed. You choose Red- or Smoked-lens LED lamp (sold separately) to match your styling direction.

Fits '14-later Touring models equipped with King or Chopped Tour-Pak luggage and Tour-Pak Spoiler Light Kit P/N 53000238 or 53000239.

#### '97-'13 Models

Easy-to-install Tour-Pak Spoiler kit includes brilliant red-lens LED lamp and wiring harness.

Fits '97-'13 Touring and Trike models with King, Chopped or Razor-Pak Tour-Pak luggage. Spoiler may contact antennas on FLHTK models.

#### Also available:

##### LED LIGHT KIT – TOUR-PAK SPOILERS

Custom fit to Tour-Pak Spoilers, these fast-acting LED Light Kits operate as a supplemental rear running light and brake light. The high mounting position places the light in the line-of-sight of following vehicles, and the bright, fast-acting red LED lamps get you noticed. Wiring is concealed for a clean, custom installation. Available with red or smoked lens.

Fits '14-later Touring models equipped with Tour-Pak Spoiler Kit. FLHX, FLHXS, FLTRX and FLTRXS models will require separate purchase of Wiring Harness P/N 69201157.

**53000238** Red Lens. **\$99.95**

**53000239** Smoked Lens. **\$99.95**

##### LED REPLACEMENT LIGHT KITS

Fits Color-Matched Tour-Pak Spoiler or Saddlebag Spoiler on '94-'13 models.

**68160-99** Tour-Pak Spoiler. **\$64.95**

**68192-99** Saddlebag Spoiler. **\$44.95**

See page 811 for a complete list of available Color-Matched options.

\*NOTE: This product is a "Paint to Order" accessory. Please allow for an average of 5 weeks delivery for this item.



A. COLOR-MATCHED SADDLEBAG LID SPOILER KIT – '14-LATER MODELS



A. COLOR-MATCHED SADDLEBAG LID SPOILER KIT – '93-'13 MODELS



B. COLOR-MATCHED TOUR-PAK SPOILER KITS – '14-LATER MODELS



B. COLOR-MATCHED TOUR-PAK SPOILER KITS – '93-'13 MODELS



# TOURING & TRIKE 403

Saddlebag Accessories



C. ROAD KING CLASSIC LEATHER SADDLEBAG KIT

## C. ROAD KING® CLASSIC LEATHER SADDLEBAG KIT

The perfect combination of style and function. These traditional leather saddlebags are a direct replacement for the Color-Matched Hard Saddlebags featured on the Road King® model and their installation transforms the look of your ride. The bags are formed from a leather-covered composite to hold its shape and feature embossed leather accents, a Road King Classic medallion and easy-open quick-release clips hidden behind traditional leather strap and chrome buckle closures. Kit includes left and right bags and reflectors.

**90201079** **\$899.95**

Fits '14-later Road King models.

## D. ROAD KING® SADDLEBAG LOCK SET

Add theft deterrence to your Road King® rigid leather saddlebags. Special order keyed-to-match lock set available. Contact your Dealer with your vehicle key code. Kit includes two keys.

**46316-04** **\$279.95**

Fits '98-later Road King Classic models.

**46287-04** **\$69.95**

Fits '04-'07 Road King Custom models.

## E. TRIKE SADDLEBAGS

Add additional storage at your fingertips. These vinyl-wrapped rigid side bags are a perfect match to either the Original Equipment or accessory seats and are contoured to fit comfortably under the passenger's legs. Featuring an easy-to-grip chrome-plated Bar & Shield finger pull, the forward-opening bags snap shut with a strong magnetic closure. The interior can accommodate 2 soda cans or water bottles side by side and is the ideal spot for sunscreen, glasses and your cell phone. Luggage capacity: 700 cubic inches total.

**84031-11** **\$419.95**

Fits '09-later FLHTCUTG and FLHXXX models.

## F. SADDLEBAG EXTENSION KIT

Give your saddlebags the "tail dragger" look. Originally featured on the '09 CVO™ Road Glide®, these extensions visually stretch the saddlebags and wrap around the exhaust for a true "low rider" look. Manufactured from the same durable ABS material as the Original Equipment saddlebags, these primed extensions are ready to paint and attach to the saddlebag bottoms. No filler or re-painting of the Original Equipment bag is necessary. Finish the look with available Color-Matched Saddlebag Filler Strips (sold separately).

**90999-09** **\$349.95**

Fits '04-'13 Touring models equipped with Color-Matched Hard Saddlebags.



D. ROAD KING SADDLEBAG LOCK SET



E. TRIKE SADDLEBAGS



F. SADDLEBAG EXTENSION KIT

Notice: The prices appearing in this catalog are the manufacturer's suggested retail prices. Actual retail prices may vary.

# 404 TOURING & TRIKE

Saddlebag Accessories

## A. COLOR-MATCHED STRETCHED SADDLEBAG BOTTOMS\*

Add the long low "slammed" look to your Touring bike without compromising the suspension travel and ride height. These Stretched Saddlebag Bottoms wrap around the exhaust to add visual length to the bike and hide the muffler bracket and hanger from view. The full-depth extended Saddlebag Bottoms add additional storage capacity and are manufactured of the same materials as the latest Original Equipment saddlebags for a glass-smooth painted surface. Available primed or factory-finished to match your Original Equipment painted finish. These Stretched Bottoms are pre-drilled to accept your existing saddlebag lids and latches. Simply attach the extended saddlebag bottom to your saddlebag lids with the included hardware and install on the bike like the original bags.

### Available to fit:

Fits '14-later Touring models with Color-Matched Hard Saddlebags.

Fits '93-'13 Touring models with Color-Matched Hard Saddlebags.

See page 810 for a complete list of available Color-Matched options.



A. COLOR-MATCHED STRETCHED SADDLEBAG BOTTOMS – '14-LATER MODELS  
(SHOWN WITH SADDLEBAG LID SPOILERS)



A. COLOR-MATCHED STRETCHED SADDLEBAG BOTTOMS – '93-'13 MODELS  
(SHOWN WITH SADDLEBAG LID SPOILERS)

\*NOTE: This product is a "Paint to Order" accessory. Please allow for an average of 5 weeks delivery for this item.

Notice: The prices appearing in this catalog are the manufacturer's suggested retail prices. Actual retail prices may vary.



# TOURING & TRIKE 405

Saddlebag Accessories



**B. COLOR-MATCHED SADDLEBAG FILLER STRIP KITS – SOLID ('14-LATER MODEL)**



**B. COLOR-MATCHED SADDLEBAG FILLER STRIP KITS – SLOTTED ('14-LATER MODEL)**



**B. COLOR-MATCHED SADDLEBAG FILLER STRIP KIT – SOLID ('09-'13 MODEL)**



**B. COLOR-MATCHED SADDLEBAG FILLER STRIP KIT – SLOTTED ('09-'13 MODEL)**

## **B. COLOR-MATCHED SADDLEBAG FILLER STRIP KITS\***

For those who seek perfection, these kits fill in the gaps between the fender and the rear of the saddlebags, hiding the saddlebag mounting bracket. Choose between primed, highly polished chrome or Color-Matched to your sheet metal and bags for a truly custom look.

### **Available to fit:**

#### **Solid**

Fits '14-later Touring models with hard saddlebags. Does not fit with accessory Saddlebag Guard Rails. Does not fit Street Glide®, Road Glide®, Tri Glide® or Freewheeler™ models.

#### **Slotted**

Fits '14-later Touring models with hard saddlebags and accessory saddlebag guard rails. Does not fit Street Glide, Road Glide, Tri Glide or Freewheeler models.

#### **Solid**

Fits '09-'13 FLHT, FLHR and FLHTK models.

#### **Slotted**

Fits '09-'13 Touring models equipped with Nostalgic Saddlebag Rail P/N 91286-09 and 91286-10.

#### **Solid**

Fits '93-'08 Electra Glide® (except FLHX) models, '94-'08 FLHR models (except FLHRCI with rear docking kit and FLHRS) and '93 FLHS models. (Will not fit models equipped with Nostalgic and Triple Rail Saddlebag Guard Rails or chrome Saddlebag Guard Kit P/N 90839-93A, 91216-97; Electra Glo™ Light Rails; Leather Saddlebags P/N 90652-94A, 90843-93; or with Fender Rail P/N 91019-92A. Does not fit '98-'08 FLTR.)

**Also available** (not shown):

#### **CHROME SADDLEBAG FILLER STRIP KIT**

Fits '95-'08 Electra Glide (except FLHX), '94-'08 FLHR (except FLHRS) and '93 FLHS models equipped with Nostalgic Saddlebag Guard Rails P/N 90839-94; fits '98 FLHRCI with Nostalgic Saddlebag Guard Rails P/N 91265-98. (Will not fit models equipped with Leather Saddlebags P/N 90652-94A, 90843-93 or Fender Rail P/N 91019-92A. Will not fit '98-'08 FLHRCI with H-D® Detachables™ Docking Kit or '98-'08 FLTR.)

**45896-98** Slotted.

**\$109.95**

See page 809 for a complete list of available Color-Matched options.

\*NOTE: This product is a "Paint to Order" accessory. Please allow for an average of 5 weeks delivery for this item.

Notice: The prices appearing in this catalog are the manufacturer's suggested retail prices. Actual retail prices may vary.

# 406 TOURING & TRIKE

## Saddlebag Guards

### A. SADDLEBAG SUPPORT KIT

Complete the stripped-down look by eliminating the rear saddlebag guards. This kit replaces the Original Equipment loop saddlebag guard and support with an inconspicuous bolt-on bar that supports the saddlebag for a clean, custom appearance. Kit includes left and right support and all necessary mounting hardware.

**90200981** **\$99.95**  
Fits '14-later FLHR, FLHTCU, FLHTCUL, FLHTK, FLHTKL and FLHTKSE models. Stock on '14-later FLHRSE, FLHX, FLHXS, FLHXSE, FLTRUSE, FLTRX and FLTRXS models.

**90881-09A** **\$149.95**  
Fits '09-'13 Touring models (except FLHRC and FLHTCUSE4/5/6/7/8). Stock on '09-'13 FLHX, FLTR, FLTRU, FLTRX, FLHRSE5, FLHXSE/2/3, FLTRSE3 and FLTRXSE/2 models. Does not fit with Saddlebag Filler Strip Kits.

**46565-04** **\$149.95**  
Fits '97-'08 Touring (except FLHRC) models. Stock on FLHRS, FLHX and '04-'08 FLTR models.



**A. SADDLEBAG SUPPORT KIT ('14-LATER MODELS)**

### B. REAR SADDLEBAG GUARD AND SUPPORT KIT\*

Add protection and style to your ride. Complete kit replaces the under-saddlebag support found on some Touring models with loop-style saddlebag guards for a traditional look. Featured as Original Equipment on many Touring models, these chrome-plated guards protect the leading edge of the saddlebag, and are shaped to accept Saddlebag Guard Bags (sold separately) for added storage. Kit includes saddlebag supports, left and right guards and all necessary mounting hardware.

**90200787** Chrome. **\$229.95**  
Fits '14-later FLHX, FLHXS, FLRTX, FLTRXS, FLTRUSE and FLHRSE models. Stock on '14-later FLHR, FLHRC, FLHTCU, FLHTCUL, FLHTK, FLHTKL and FLHTKSE models.

**90200788** Gloss Black. **\$229.95**  
Fits '14-later FLHX, FLHXS, FLRTX, FLTRXS, FLTRUSE and FLHRSE models.

**49282-09B** Chrome. **\$229.95**  
Fits '09-'13 FLHX, FLTR, FLTRU, FLTRX, FLHRSE5, FLHXSE/2/3, FLTRSE3 and FLTRXSE/2 models.

**49291-07** Chrome. **\$229.95**  
Fits '04-'08 FLHRS, FLHX, FLTR and '05 FLHTCSE2 models.



**A. SADDLEBAG SUPPORT KIT ('09-'13 MODELS)**



**B. REAR SADDLEBAG GUARD AND SUPPORT KIT – CHROME ('14-LATER MODELS)**



**B. REAR SADDLEBAG GUARD AND SUPPORT KIT – GLOSS BLACK '14-LATER MODELS**



**B. REAR SADDLEBAG GUARD AND SUPPORT KIT – CHROME '09-'13 MODELS**



**\*WARNING:** These guards may provide limited leg and cosmetic vehicle protection under unique circumstances (fall over while stopped, very low speed slide). They are not made nor intended to provide protection from bodily injury in a collision with another vehicle or any other object.

*Notice: The prices appearing in this catalog are the manufacturer's suggested retail prices. Actual retail prices may vary.*



# TOURING & TRIKE 407

## Saddlebag Guards



**C. REAR SADDLEBAG GUARDS – GLOSS BLACK ('14-LATER MODELS)**



**C. REAR SADDLEBAG GUARDS – GLOSS BLACK\***

Add a sinister look to your ride. Designed to replace the Original Equipment chrome-plated guards featured on many Touring models, the blacked-out finish minimizes the look without a reduction in protection.

**90200791 \$179.95**

Fits '14-later FLHR, FLHRC, FLHTCU, FLHTCUL, FLHTK, FLHTKL and FLHTKSE models. Installation requires reuse of Original Equipment saddlebag supports.

**49283-09 \$189.95**

Fits '09-'13 Touring models. FLHX, FLTR, FLTRU, FLTRX, FLHRSE5, FLHXSE/2/3, FLTRSE3 and FLTRXSE/2 models require separate purchase of Saddlebag Supports P/N 49194-09A and 90781-09A, Nut P/N 7531 (Qty 2) and Antenna Mounting Bracket P/N 76516-09.

**46548-03 \$189.95**

Fits '97-'08 Touring models. ('04-'08 FLTR, FLHX and FLHRS models require the separate purchase of Saddlebag Supports P/N 49194-85 and 90781-93 and two P/N 3601 and 7686.)

**D. COMFORT PROFILE REAR SADDLEBAG GUARD KIT\***

The unique profile of these chrome-plated Rear Saddlebag Guards gives your passenger more leg room. A perfect replacement for the Original Equipment saddlebag guards.

**49179-09 \$189.95**

Fits '09-'13 Touring models (except FLHTC, FLHTCU and FLHTCUSE4/5/6/7/8). FLHX, FLTR, FLTRU, FLTRX, FLHRSE5, FLHXSE/2/3, FLTRSE3 and FLTRXSE/2 models require separate purchase of Saddlebag Supports P/N 49194-09A and 90781-09A, Nut P/N 7531 (Qty 2) and Antenna Mounting Bracket P/N 76516-09. FLHRC models require separate purchase of reflectors P/N 59370-98 and 59371-98.

**49087-01 \$189.95**

Fits '97-'08 FLHR, FLTR, FLHX and FLHT models. FLHRCI models require separate purchase of Reflector P/N 59370-98 and 59371-98. '04-'08 FLTR, FLHX and FLHRS models require separate purchase of Saddlebag Supports P/N 49194-85 and 90781-93 and two each of P/N 3601 and 7686. (Will not fit Saddlebag Guard Bags.)



**C. REAR SADDLEBAG GUARDS – GLOSS BLACK ('09-'13 MODELS)**



**E. BILLET SADDLEBAG MOUNT BRACKET TRIM**

Give the rider following you something to look at. This chrome-plated "ball-milled" billet bracket replaces the mounting bolts between the lower saddlebag rail and the fender, for a clean, custom look. Kit includes two brackets and required hardware.

**90200666 \$69.95**

Fits '09-'13 Touring models (except FLHX, FLHXSE/2/3, FLTRX and FLTRXSE/2). Does not fit with Saddlebag Guard Rails P/N 91179-10, 91286-10, or Saddlebag Filler Strip Kits.

**91777-02 \$69.95**

Fits '96-'08 Touring models (except FLHX). Does not fit with Saddlebag Guard Rails P/N 90839-04 or 91265-98, Filler Strip Kits P/N 45898-98, 45899-98, 45896-98 or 45897-98 or Active Exhaust Kit P/N 65467-05.



**D. COMFORT PROFILE REAR SADDLEBAG GUARD KIT**



**E. BILLET SADDLEBAG MOUNT BRACKET TRIM ('96-'08 MODELS)**



**E. BILLET SADDLEBAG MOUNT BRACKET TRIM ('09-'13 MODELS)**



**\*WARNING:** These guards may provide limited leg and cosmetic vehicle protection under unique circumstances (fall over while stopped, very low speed slide). They are not made nor intended to provide protection from bodily injury in a collision with another vehicle or any other object.

Notice: The prices appearing in this catalog are the manufacturer's suggested retail prices. Actual retail prices may vary.

# 408 TOURING & TRIKE

## Saddlebag Rails

### A. SADDLEBAG GUARD RAILS

Protect the sides and rear of your saddlebags from bumps and bruises. Saddlebag Guard Rails surround the lower portion of the bag, and add a traditional look to your Touring bike. The thick-walled chrome-plated tubing and the elegant cast mounts clamp securely to the Original Equipment saddlebag guards for a seamless look. The rails are pre-assembled to simplify installation, and the kit includes left and right rails and all required mounting hardware.

**90200561** **\$289.95**

Fits '14-later Touring models (except FLHRC, FLHRSE, FLHX, FLHXS, FLTRX, FLTRXS and FLTRUSE). FLHTKSE models require separate purchase of Slotted Saddlebag Filler Strips.



**A. SADDLEBAG GUARD RAILS  
(‘14-LATER MODELS)**

### B. TWIN RAIL CHROME SADDLEBAG GUARD KIT

Kit comes with rear saddlebag guards, side rails, mounting hardware and instructions for easy installation.

**90892-09** **\$339.95**

Fits '09-'13 FLHR, FLHT, FLHTK, FLTR and FLTRU models. Stock on '09-'13 FLHTC and FLHTCU models. FLTR and FLTRU models require separate purchase of Saddlebag Supports P/N 49194-09A, 90781-09A, Nut P/N 7531 (qty 2) and Antenna Mounting Bracket P/N 76516-09.

**91216-97** **\$339.95**

Fits '97-'08 FLHT, FLHR, FLHTCUSE/2/3 and '98-'08 FLTR models. '04-'08 FLTR models require the separate purchase of Saddlebag Supports P/N 49194-85 and 90781-93, Nut P/N 7686 (Qty 2) and Screw P/N 3601 (Qty 2).



**B. TWIN RAIL CHROME SADDLEBAG GUARD KIT  
(‘09-‘13 MODELS)**

### C. NOSTALGIC SADDLEBAG GUARD RAILS

Forge a link with the Panhead era by easily bolting on these Nostalgic Saddlebag Guard Rails. The soft curves of the nostalgic twin tube design hug the shape of the bag for a custom look, and the sturdy welded steel tubing is hand-polished and chrome-plated for a sparkling finish.

**91286-10** **\$239.95**

Fits '09-'13 FLHR, FLHT and FLHTK models. Also fits FLTR and FLTRU models with separate purchase of Chrome Saddlebag Guard Kit P/N 49282-09B.

**90839-94A** **\$239.95**

Fits '95-'08 FLHT Standard, '94-'08 FLHR and '93 FLHS models. (Does not fit FLHX, FLHRC and FLHRS.)

**91179-10** **\$239.95**

Fits '09-'13 FLHRC models.

**91265-98A** **\$239.95**

Fits '98-'08 FLHRC/I models only.



**C. NOSTALGIC SADDLEBAG GUARD RAILS – HARD SADDLEBAGS**



**C. NOSTALGIC SADDLEBAG GUARD RAILS – ROAD KING CLASSIC SADDLEBAGS**

*Notice: The prices appearing in this catalog are the manufacturer's suggested retail prices. Actual retail prices may vary.*



# TOURING & TRIKE 409

Saddlebag Rails



**D. SADDLEBAG GUARD RAIL INSERTS**

## D. SADDLEBAG GUARD RAIL INSERTS

These ribbed trim panels nest between the saddlebag guard rails for a gleaming chrome accent. Styled to complement the raised rib design of Harley-Davidson® front fender skirts, engine/transmission interface covers and passenger foot-board covers, the Guard Rail Inserts complete a fender-to-fender customizing statement. Kit includes all necessary mounting hardware.

**90251-09** **\$144.95**  
Fits '09-'13 Electra Glide® Classic and Ultra Classic® models and models equipped with Twin Rail Saddlebag Guard Rails.

**90206-02** **\$144.95**  
Fits '93-'08 Electra Glide Classic and Ultra Classic, '98-'08 Road Glide®, '93-'96 Tour Glide™ Ultra Classic and '93-'08 Electra Glide Standard with Chrome Saddlebag Guard Kit P/N 90839-93A.

## E. SKULL SADDLEBAG GUARD RAIL INSERTS

These ribbed trim panels with a chrome skull medallion nest between the saddlebag guard rails for a gleaming chrome accent. Styled to complement the Skull Collection front fender skirts, the Guard Rail Inserts complete a fender-to-fender customizing statement. Kit includes all necessary mounting hardware.

**90255-09** **\$144.95**  
Fits '09-'13 Electra Glide Classic and Ultra Classic models and models equipped with Twin Rail Saddlebag Guard Rails.

**90214-05** **\$144.95**  
Fits '93-'08 Electra Glide Classic and Ultra Classic, '98-'08 Road Glide, '93-'96 Tour Glide Ultra Classic and '93-'08 Electra Glide Standard with Chrome Saddlebag Guard Kit P/N 90839-93A.



**E. SKULL SADDLEBAG GUARD RAIL INSERTS**

## F. ELECTRA GLO™ LIGHT RAILS

Molded housings incorporate wave-soldered circuit boards with tungsten filament bulbs for enhanced illumination. Precision-molded Lexan® polycarbonate lenses lined with light-diffusing panels offer consistent, even light dispersion. Assembled and wired for bolt-on and plug-in installation. Kit includes bracketry, hardware, and instructions.

**68682-09** **\$599.95**  
Fits '09-'13 Road King®, Street Glide® and Electra Glide models equipped with hard saddlebags. Installation on models not factory-equipped with saddlebag guards requires separate purchase of Saddlebag Guard Rail Kit P/N 90892-09.

**90531-93** **\$579.95**  
Fits '94-'08 FLTCU, FLHTCU, FLHTC and '98-'03 FLTR models. Will not fit '06-'08 FLHX models.

NOTE: Installation on '93 FLHS and '94-'96 FLHR models requires Saddlebag Guard Kit P/N 90839-93A. Installation on '97-later FLHT and FLHR (except '98-later FLHRC and FLHRS) models requires Saddlebag Guard Kit P/N 91216-97. Must be purchased separately. To install on '93-'96 models equipped with accessory Triple Saddlebag Rail Kit P/N 90845-93A, Left and Right Outer Guard Rail Clamps P/N 90919-93 and P/N 90917-93 are required and must be purchased separately.



**F. ELECTRA GLO LIGHT RAILS**

Notice: The prices appearing in this catalog are the manufacturer's suggested retail prices. Actual retail prices may vary.

# 410 TOURING & TRIKE

## Saddlebag Lid Rails

### A. TOURING SADDLEBAG LID RAILS

Protect your saddlebag lids from scratches and boot marks. Elegant welded rails are formed of high-quality tubing, and are beautifully polished and chrome plated to a mirror-like finish. The rails are shaped to wrap down the front of the saddlebag lid, and are designed to accept model-specific medallions (sold separately) for a custom touch. The three-point mount simplifies installation, and the complete kit includes left and right rails, and mounting hardware.

**90200876** **\$139.95**  
Fits '14-later Touring models with Color-Matched Hard Saddlebags.

**90200737** **\$129.95**  
Fits '93-'13 Touring models with Color-Matched Hard Saddlebags. Does not fit models with leather covered bags or models equipped with Saddlebag Wing Tips P/N 53826-00B.



A. TOURING SADDLEBAG LID RAILS

### B. AIR WING SADDLEBAG LID RAIL KIT

The low-profile aerodynamic styling of the Air Wing Saddlebag Lid Rail enhances the look and protects the lid of your Color-Matched Hard Saddlebags. Available in mirror-chrome or gloss black finish, the rails cascade down the front of the saddlebag to protect the paint from a misplaced boot heel, and the die-cast wing design at the rear complements the style of the Air Wing Luggage Rack. Kit includes all necessary mounting hardware. For added visibility, add the available Air Wing Light Kit (sold separately).

Fits '14-later Touring models with Color-Matched Hard Saddlebags.

**90200792** Chrome. **\$149.95**  
**90200793** Gloss Black. **\$149.95**

Fits '93-'13 Touring models with Color-Matched Hard Saddlebags. Does not fit models with leather covered bags or models equipped with Saddlebag Wing Tips P/N 53826-00B.

**88299-09** Chrome. **\$139.95**  
**90200391** Gloss Black. **\$139.95**



B. AIR WING SADDLEBAG LID RAIL KIT – CHROME

### C. AIR WING RAIL LED LIGHT KIT

Custom fit to the Air Wing Rails, this fast-acting LED Light Kit operates as a supplemental rear running light and brake light. The high and outside mounting position places the lights in the line-of-sight of following vehicles, and the bright, fast-acting LED lamps get you noticed. Wiring is concealed inside the rack tubes for a clean, custom installation.

Fits '14-later Touring models equipped with Air Wing Saddlebag Rails P/N 90200792 or 90200793.

**68000115** Red. **\$79.95**  
**68000114** Smoked. **\$79.95**

Fits '93-'13 Touring models equipped with the Air Wing Saddlebag Lid Rails P/N 88299-09, 90200391 and '09-'13 Trike models equipped with Air Wing Trike Fender Rails P/N 61400058.

**68286-10** Smoked. **\$79.95**  
**68388-10** Red. **\$79.95**



B. AIR WING SADDLEBAG LID RAIL KIT – GLOSS BLACK



C. AIR WING RAIL LED LIGHT KIT

*Notice: The prices appearing in this catalog are the manufacturer's suggested retail prices. Actual retail prices may vary.*



# TOURING & TRIKE 411

Saddlebag Lid Rails



**D. SADDLEBAG LID RAIL MEDALLIONS**

## D. SADDLEBAG LID RAIL MEDALLIONS

Personalize your ride. Mirror-chrome medallions fit between the forward-facing portions of the Touring Saddlebag Lid Rails or the Air Wing Saddlebag Lid Rails for a custom look. Model-specific script is deeply carved into the surface, and filled with a rich black finish for immediate identification. Chrome-plated installation bracket and stainless steel hardware mount from the back side for a clean, uncluttered look. Kit includes left and right medallion and all mounting hardware.

Fits '14-later Touring models equipped with Premium Saddlebag Lid Rails P/N 90200876 or Air Wing Saddlebag Lid Rails P/N 90200792 or 90200793.

<b>90200954</b>	Ultra.	<b>\$36.95</b>
<b>90200951</b>	Limited.	<b>\$36.95</b>
<b>90200957</b>	FLHX.	<b>\$36.95</b>

Fits '93-'13 Touring models equipped with Touring Saddlebag Lid Rails P/N 90200737 or Air Wing Saddlebag Lid Rails P/N 88299-09 or 90200391.

<b>90200741</b>	Ultra.	<b>\$29.95</b>
<b>90200740</b>	Limited.	<b>\$29.95</b>
<b>90200742</b>	FLHX.	<b>\$29.95</b>

## E. AIR WING FENDER RAIL FOR TRIKE

The low-profile aerodynamic shape of the Air Wing Fender Rail enhances the look and protects the surface of your Trike's rear fenders. The mirror-chrome rails follow the sleek contours of the fenders, and the slim rails and die-cast rear wings complement the available Air Wing Tour-Pak® Luggage Rack. Kit includes left and right rail and all necessary mounting hardware.

**61400058** Chrome. **\$169.95**  
Fits '09-later FLHTCUTG and FLHXXX models. Does not fit with Trike Fender Bra P/N 57892-11.

**Also available:**

### AIR WING RAIL LED LIGHT KIT

Custom fit to the Air Wing Rails, this fast-acting LED Light Kit operates as a supplemental rear running light and brake light. The high and outside mounting position places the lights in the line-of-sight of following vehicles, and the bright, fast-acting LED lamps get you noticed. Wiring is concealed inside the rack tubes for a clean, custom installation.

Fits '93-'13 Touring models equipped with the Air Wing Saddlebag Lid Rails P/N 88299-09, 90200391 and '09-'13 Trike models equipped with Air Wing Trike Fender Rails P/N 61400058.

<b>68286-10</b>	Smoked.	<b>\$79.95</b>
<b>68388-10</b>	Red.	<b>\$79.95</b>



**E. AIR WING FENDER RAIL FOR TRIKE**



**E. AIR WING FENDER RAIL FOR TRIKE**



**E. AIR WING FENDER RAIL FOR TRIKE (SHOWN WITH AIR WING LIGHT KIT)**

*Notice: The prices appearing in this catalog are the manufacturer's suggested retail prices. Actual retail prices may vary.*

## 412 TOURING & TRIKE

### Saddlebag Accessories

#### A. BILLET SADDLEBAG HINGE COVER KIT – EDGE CUT

Dress your saddlebags in style. Edge Cut Saddlebag Hinge Covers feature a rich black finish that is machined to expose the highlights of raw aluminum. The contrasting cut-back look makes a powerful visual statement, and works great with both traditional and contemporary customizing styles. These covers replace the Original Equipment covers, but retain the stock hinges and locks for easy installation. Kit includes left and right covers, mounting hardware and saddlebag-mounted red reflectors.

**90200915** **\$159.95**

Fits '14-later Touring models equipped with hard saddlebags. HDI models require separate purchase of amber Reflector P/N 59289-92 and 59290-92.

**90200421** **\$139.95**

Fits '93-'13 Touring models equipped with hard saddlebags. HDI models require separate purchase of Reflector P/N 59289-92 and 59290-92.



**A. BILLET SADDLEBAG HINGE COVER KIT –  
EDGE CUT  
(90200915 SHOWN)**



**A. BILLET SADDLEBAG HINGE COVER KIT –  
EDGE CUT  
(90200421 SHOWN)**

#### B. BILLET SADDLEBAG HINGE COVER KIT – CHROME GROOVED

This sweep of chrome will set the tone for a very special Touring custom. Manufactured from billet aluminum, this polished and plated cover replaces the Original Equipment saddlebag hinge for a striking look. The grooved "ball-milled" design and curved leading and trailing edge add a feeling of forward motion, even while parked on Main Street. Kit includes chrome-plated mounting hardware and red saddlebag-mounted reflectors.

**90201084** **\$159.95**

Fits '14-later Touring models equipped with hard saddlebags. HDI models require separate purchase of amber Reflector P/N 59289-92 and 59290-92.

**90645-03A** **\$139.95**

Fits '93-'13 Touring models equipped with hard saddlebags. HDI models require separate purchase of Reflector P/N 59289-92 and 59290-92.



**B. BILLET SADDLEBAG HINGE COVER KIT –  
CHROME GROOVED  
(90201084 SHOWN)**



**B. BILLET SADDLEBAG HINGE COVER KIT –  
CHROME GROOVED  
(90645-03A SHOWN)**

#### C. SADDLEBAG LATCH AND HINGE KIT – GLOSS BLACK

Gloss Black Saddlebag Hinge Covers and finger-operated Latches are an easy way to give your Touring bike a unique monochrome look. These latches add a dark custom touch to the motorcycles' s profile, and complement almost any paint combination. Easy to install with Original Equipment hardware and reflectors.

**90200914** Latch Lever and Hinge Cover Kit. **\$194.95**

Fits '14-later Touring models equipped with hard saddlebags. Hinge Cover is standard equipment on FLHX models.

**90201052** Latch Lever only. **\$74.95**

Fits '14-later Touring models equipped with hard saddlebags.



**C. SADDLEBAG LATCH AND HINGE KIT – GLOSS BLACK**



**C. SADDLEBAG LATCH AND HINGE KIT – GLOSS BLACK**

*Notice: The prices appearing in this catalog are the manufacturer's suggested retail prices. Actual retail prices may vary.*



# TOURING & TRIKE 413

Saddlebag Accessories



**D. SADDLEBAG LATCH KIT – THE BURST COLLECTION**

## D. SADDLEBAG LATCH KIT – THE BURST COLLECTION

Sculpted machining sends reflections of light in all directions. Latches feature a rich black anodized finish that is machined to expose the highlights of raw aluminum. The contrasting cut-back look makes a powerful visual statement, and works great with both traditional and contemporary customizing styles. These covers replace the Original Equipment latch covers, but retain the stock hinges and locks for easy installation. Kit includes left and right hinge covers, chrome plated mounting hardware and saddlebag-mounted reflectors.

**90200821** **\$169.95**

Fits '93-'13 Touring models equipped with hard saddlebags. HDI models require separate purchase of Reflectors P/N 59289-92 and 59290-92.

## E. BILLET SADDLEBAG LATCH KIT – MIDNIGHT FLAME

Styled to carry the "Flame" theme from front to back, this Flame Saddlebag Latch will get you noticed. The smooth black rubber insert is set into the brilliant chrome surface, defining the traditional "Hot Rod" flame pattern. The billet covers replace the Original Equipment latch covers, but retain the stock hinges and locks for easy installation. Kit includes chrome-plated mounting hardware and saddlebag-mounted reflectors.

**90690-04A** **\$159.95**

Fits '93-'13 Touring models equipped with hard saddlebags. HDI models require separate purchase of Reflector P/N 59289-92 and 59290-92.

## F. SADDLEBAG LATCH PLATE

Saddlebag Latch Plates are an easy way to give your Touring bike a unique monochrome look. Available in Vivid Black or Primed finish, these latches add a splash of color to the motorcycle profile. Easy to install with Original Equipment hardware.

Fits '93-'13 Touring models equipped with Color-Matched Hard Saddlebags. HDI models require separate purchase of Reflectors P/N 59289-92 and 59290-92.

**91143-06BEO** Primed. (pair) **\$84.95**

**90853-06DH** Vivid Black – Right Side. **\$49.95**

**90857-06DH** Vivid Black – Left Side. **\$49.95**



**E. BILLET SADDLEBAG LATCH KIT – MIDNIGHT FLAME**

## G. SADDLEBAG LID SPEAR TRIM KIT

These die-cast and chrome-plated trim spears add a sweeping slash of chrome to the saddlebag lid. Kit includes left and right trim strips, gaskets, mounting hardware and installation template.

**53878-03** **\$84.95**

Fits '93-'13 Touring models equipped with Color-Matched hard saddlebags. Does not fit with Saddlebag Lid Speakers, Saddlebag Lid Rails, Lid Bra Kit P/N 57805-03 or previously installed Saddlebag Lid Organizer P/N 53548-02A.

## H. SADDLEBAG WING TIPS

This chrome-plated steel trim is an ideal way to customize your saddlebag lids, and to protect the leading edge from road debris. Mounting hardware included. Sold in pairs.

**53826-00B** **\$74.95**

Fits '93-'13 Touring models equipped with Color-Matched Hard Saddlebags. (Does not fit with Saddlebag Rails except P/N 53662-87T.)

## I. ROAD KING® CLASSIC SADDLEBAG TRIM

Chrome-plated, extruded and machined aluminum trim for saddlebag lid. Saddlebag trim complements the details of the Road King® fuel console. Includes four extruded trim spears and polished, stainless steel button head mounting hardware. Designed for use on the FLHRC leather saddlebags. Also looks great on Color-Matched hard bags.

**53767-98** **\$134.95**

Fits '98-later Road King Classic models. Also fits '93-'13 models with H-D® Color-Matched Hard Saddlebags. Does not fit with Saddlebag Lid Speakers.



**F. SADDLEBAG LATCH PLATE – VIVID BLACK**



**G. SADDLEBAG LID SPEAR TRIM KIT**



**H. SADDLEBAG WING TIPS**



**I. ROAD KING CLASSIC SADDLEBAG TRIM**

Notice: The prices appearing in this catalog are the manufacturer's suggested retail prices. Actual retail prices may vary.

# 414 TOURING & TRIKE

## Saddlebag Lighting

### A. ELECTRA GLO™ LED SADDLEBAG RUN/BRAKE/TURN LAMP\*

Add functional lighting to the rear of your Touring bike. These running, directional and brake lights command the attention of following vehicles. The bright, fast-acting LED lamps glow red when the ignition is on, and intensify when the turn signals or brakes are activated. The lamps act as a supplement to the Tour-Pak® luggage mounted rear lighting. The lamps are housed in a low-profile chrome frame that is contoured to hug the curve of the hard saddlebags. The self-adhesive lamps fit seamlessly beneath the saddlebag lid and add a stylish touch of color, even when the bike is parked. Complete kit includes left and right lamps, modulator and quick-disconnect wiring harness.

Fits '14-later FLHTCU, FLHTCUL, FLHTK and FLHTKL models. Does not fit FLHTKSE.

<b>67800241</b>	Red Lens.	<b>\$209.95</b>
<b>67800242</b>	Smoked Lens.	<b>\$209.95</b>

Fits '14-later FLHX, FLHXS, FLTRX and FLTRXS models. Does not fit Canadian models.

<b>67800448</b>	Red Lens.	<b>\$209.95</b>
<b>67800450</b>	Smoked Lens.	<b>\$209.95</b>

Fits '14-later FLHR models with hard saddlebags. Also fits FLHTKSE, FLHRSE, FLTRUSE and Canadian FLHX, FLHXS, FLTRX and FLTRXS models.

<b>67800449</b>	Red Lens.	<b>\$209.95</b>
<b>67800451</b>	Smoked Lens.	<b>\$209.95</b>

### B. ELECTRA GLO SADDLEBAG SIDE MARKER LIGHT KIT

This wrap-around Side Marker Light Kit adds a splash of light to the lower edge of the color-matched saddlebags. Available in your choice of red or smoked lens, the bright band of LED lamps is housed in a mirror chrome frame that hugs the bottom of the saddlebag. The low-profile self-adhesive Electra Glo™ lamps can be installed on models equipped with standard-length saddlebags, and are compatible with optional saddlebag guard rails. Easy to install kit includes left and right lamp and quick-disconnect wiring harness.

Fits '14-later Touring models with hard saddlebags. Not compatible with CVO™ or other models equipped with Stretched Saddlebags. Installation requires separate purchase of Electrical Connection Update Kit P/N 69200722.

<b>68000082</b>	Red Lens.	<b>\$249.95</b>
<b>68000083</b>	Smoked Lens.	<b>\$249.95</b>



A. ELECTRA GLO LED SADDLEBAG RUN/BRAKE/TURN LAMP



A. ELECTRA GLO LED SADDLEBAG RUN/BRAKE/TURN LAMP – SMOKED LENS



B. ELECTRA GLO SADDLEBAG SIDE MARKER LIGHT KIT – RED LENS



B. ELECTRA GLO SADDLEBAG SIDE MARKER LIGHT KIT – SMOKED LENS



B. ELECTRA GLO SADDLEBAG SIDE MARKER LIGHT KIT – RED AND SMOKED LENS



**\*WARNING:** Disconnecting your DOT requirement brake lamp could reduce your visibility to others and result in death or serious injury.

Notice: The prices appearing in this catalog are the manufacturer's suggested retail prices. Actual retail prices may vary.



# TOURING & TRIKE 415

Luggage Accessories



**C. SADDLEBAG GUARD BAG WITH WATER BOTTLE HOLDER – BAR & SHIELD LOGO ('14-LATER MODELS SHOWN)**

**C. SADDLEBAG GUARD BAG WITH WATER BOTTLE HOLDER**

Convenient on-the-go storage. Sturdy synthetic leather bags snap to the saddlebag guards for easy access. The storage compartment features a hook-and-loop outer flap and a zippered inner closure to store sunglasses, wallets and cell phones, and the adjoining sleeve securely grips a removable water bottle to help keep you hydrated on the road.

**Bar & Shield Logo**

Fits '93-later Touring models equipped with Saddlebag Guards.

<b>93300060</b>	Right Side.	<b>\$79.95</b>
<b>93300061</b>	Left Side.	<b>\$79.95</b>

**Road King® Classic Concho**

Fits '93-'13 Touring models equipped with saddlebag guard rails. Does not fit Comfort Profile Guard Rails.

<b>92137-05</b>	Left Side.	<b>\$84.95</b>
<b>92136-05</b>	Right Side.	<b>\$84.95</b>



**C. BAG WITH WATER BOTTLE HOLDER – BAR & SHIELD LOGO ('93-'13 MODELS SHOWN)**

**C. BAG WITH WATER BOTTLE HOLDER – ROAD KING CLASSIC CONCHO ('93-'13 MODELS SHOWN)**

**D. SADDLEBAG GUARD BAG**

Keep your essentials close at hand. Bags are constructed of sturdy synthetic leather, with a hook-and-loop flap covers a dual zippered opening that provides easy access to the interior. A separate internal zippered soft pouch is perfect for storing smaller items or sunglasses. Synthetic leather bags snap tightly to the saddlebag guard.

**Bar & Shield Logo**

Fits '93-later Touring models equipped with Saddlebag Guards.

<b>93300062</b>	Right Side.	<b>\$79.95</b>
<b>93300063</b>	Left Side.	<b>\$79.95</b>

**Road King Classic Concho**

Fits '93-'13 Touring models equipped with saddlebag guard rails. Does not fit Comfort Profile Guard Rails.

<b>91219-98</b>	Left Side.	<b>\$84.95</b>
<b>91220-98</b>	Right Side.	<b>\$84.95</b>



**D. SADDLEBAG GUARD BAG – BAR & SHIELD LOGO ('14-LATER MODELS SHOWN)**



**D. SADDLEBAG GUARD BAG – BAR & SHIELD LOGO ('93-'13 MODELS SHOWN)**

**D. SADDLEBAG GUARD BAG – ROAD KING CLASSIC CONCHO ('93-'13 MODELS SHOWN)**

*Notice: The prices appearing in this catalog are the manufacturer's suggested retail prices. Actual retail prices may vary.*

# 416 TOURING & TRIKE

## Luggage Accessories

### A. PREMIUM TOUR-PAK® FITTED LINING

Line your Touring bike's luggage to protect your belongings and reduce noise and rattles on the road. Soft-touch felt-finish liner is formed to the interior for a perfect fit. Molded base and sides maximize the interior room, and one-piece design allows easy removal for cleaning and maintenance.

**53301-06** King Ultra Tour-Pak® **\$89.95**

Fits '93-'13 Touring and Trike models equipped with King Tour-Pak luggage with incandescent wrap-around Tail Lamp Kit. Does not fit '10-later CVO™ Touring models, FLHTK or models with Tour-Pak bottom tub mounted accessories.

**53302-07** King Classic Tour-Pak. (not shown) **\$89.95**

Fits '93-'13 Touring and Trike models equipped with King Tour-Pak luggage without incandescent wrap-around Tail Lamp Kit. Does not fit with Tour-Pak bottom tub mounted accessories.

**53000322** Chopped Tour-Pak. **\$79.95**

Fits '14-later Touring and Trike models equipped with Chopped Tour-Pak luggage. Does not fit with Tour-Pak bottom tub mounted accessories.

**53000323** King Tour-Pak. **\$89.95**

Fits '14-later Touring and Trike models equipped with King Tour-Pak luggage.

**53285-06** Chopped Tour-Pak. **\$79.95**

Fits '13-earlier Touring and Trike models equipped with Chopped Tour-Pak luggage. Does not fit with Tour-Pak bottom tub mounted accessories.

### B. PREMIUM FITTED SADDLEBAG LINING

Protect your belongings and reduce noise and rattles on the road. Premium soft-touch felt-finish liner is formed to the hard saddlebag interior for a perfect fit. Molded base and sides maximize the interior room, and one-piece design allows easy removal for cleaning and maintenance.

**90200918** **\$189.95**

Fits '14-later Touring models equipped with Color-Matched Hard Saddlebags. Does not fit Police model saddlebags.

**92189-06** **\$159.95**

Fits '93-'13 Touring models equipped with Original Equipment Color-Matched Hard Saddlebags. Does not fit Police model saddlebags.



A. PREMIUM TOUR-PAK FITTED LINING – KING ULTRA '93-'13 MODELS



A. PREMIUM TOUR-PAK FITTED LINING – KING '14-LATER MODELS



A. PREMIUM TOUR-PAK FITTED LINING – CHOPPED '14-LATER MODELS



A. PREMIUM TOUR-PAK FITTED LINING – CHOPPED '13-EARLIER MODELS



B. PREMIUM FITTED SADDLEBAG LINING – '14-LATER MODELS



B. PREMIUM FITTED SADDLEBAG LINING – '93-'13 MODELS

*Notice: The prices appearing in this catalog are the manufacturer's suggested retail prices. Actual retail prices may vary.*



# TOURING & TRIKE 417

Luggage Accessories



**C. TOUR-PAK LID FITTED LINING WITH ORGANIZER – PREMIUM BLACK**



**C. TOUR-PAK® LID FITTED LINING WITH ORGANIZER – PREMIUM BLACK**

Equip the Tour-Pak® lid to protect and store your belongings. This Premium Lid Lining features a soft-touch black felt finish to reduce noise, and a convenient series of storage pouches that provide easy access to all your essentials. Four flap pouches, and one mesh and one clear pocket provide plenty of storage and a great way to keep keys, cell phones, glasses, and papers handy. Hook-and-loop fasteners secure the one-piece formed lining to the lid, and allow easy removal for cleaning and maintenance.

**53000392** **\$159.95**  
Fits '14-later Touring and Trike models equipped with King or Chopped Tour-Pak luggage.



**D. TOUR-PAK LID ORGANIZER/LINER – GRAY**



**D. TOUR-PAK LID FITTED LINING WITH ORGANIZER – GRAY**

Add practical storage to your Tour-Pak luggage. This Lid Lining features a convenient six pocket organizer to keep smaller items conveniently at hand, and is shaped to fit the contours of the Tour-Pak lid for a finished look. The organizer features 4 enclosed pouches, 1 mesh pouch and 1 clear mobile-device pouch. The soft gray finish is the perfect match for the Original Equipment Tour-Pak bottom liner, and the hook-and-loop fasteners permit easy removal for cleaning.

**53000302** **\$134.95**  
Fits '14-later Touring and Trike models equipped with King or Chopped Tour-Pak luggage.



**E. TOUR-PAK LID ORGANIZER – COLOR-MATCHED TOUR-PAK**



**E. TOUR-PAK LID ORGANIZER – LEATHER TOUR-PAK**

**E. TOUR-PAK LID ORGANIZER**

A true innovation in storage convenience and efficiency, this ingenious lid organizer helps keep smaller items conveniently located under your Tour-Pak lid for easy access. The organizer features five different-sized nylon-meshed pockets, as well as two flaps for additional storage. A great way to keep keys, cell phones, glasses, and papers handy.

**53249-01B** **\$94.95**  
Fits '93-'13 Touring and Trike models equipped with a King, Ultra, Chopped or Razor-Pak Tour-Pak. Does not fit '08-later CVO™ Ultra models with Power Locks, or models equipped with Tour-Pak Spoiler Kit P/N 53149-series, Tour-Pak Light P/N 54302-98A, Mini Tour-Pak Lid Rack P/N 53100-96 or Contoured Tour-Pak Luggage Rack P/N 79148-06.

**54011-04** **\$89.95**  
Fits '96-'13 XL, Softail® and Touring models equipped with Leather or Synthetic Leather Tour-Pak luggage (except 79189-06). Does not fit with Tour-Pak Luggage Racks, Interior Light Kits or Lock Kits.

**F. SADDLEBAG LID ORGANIZER**

Convenient storage underneath the saddlebag lids with four easy access compartments for small items. Styled to match the Tour-Pak Lid Organizer, these easy-to-install accessories include an embroidered "Harley-Davidson" script. Sold in pairs.

**53548-02A** Hard Saddlebags. **\$84.95**  
Fits '93-'13 Touring models equipped with Color-Matched Hard Saddlebags. Does not fit with hard saddlebags on Police models, saddlebag lid rails and saddlebag lid trim kits.

**54008-04** Leather Saddlebags. **\$84.95**  
Fits Touring models equipped with FLHRC saddlebags.



**F. SADDLEBAG LID ORGANIZER – COLOR-MATCHED HARD SADDLEBAGS**



**F. SADDLEBAG LID ORGANIZER – LEATHER SADDLEBAGS**

TOURING

Notice: The prices appearing in this catalog are the manufacturer's suggested retail prices. Actual retail prices may vary.

# 418 TOURING & TRIKE

## Luggage Accessories

### A. TOUR-PAK® WALL ORGANIZER

Convenient storage system wraps the interior walls of your King Tour-Pak® for easy access to keys, cell phones, maps, and gloves. The organizer features a variety of mesh and enclosed pockets, sized perfectly to keep small items close at hand. Easily installed with included hook-and-loop tabs.

**53000303** **\$99.95**

Fits '14-later Touring and Trike models equipped with King Tour-Pak luggage.

**54014-05** **\$89.95**

Fits '93-'13 Touring and Trike models equipped with Ultra or King Tour-Pak luggage. Does not fit with Chopped or Razor-Pak Tour-Pak.



A. TOUR-PAK WALL ORGANIZER – '14-LATER MODELS

### B. SADDLEBAG WALL ORGANIZER

Convenient storage system equips the interior wall of your Color-Matched Saddlebags for easy access to keys, cell phones, maps, and gloves. The organizer features a combination of mesh and enclosed pouches and pockets that are sized for safe, rattle-free packing. The organizer features a rigid backing that easily attaches to the wall of the saddlebag with the Original Equipment quick-release saddlebag fasteners. Kit includes left- and right-hand organizer.

**90200882** **\$99.95**

Fits '14-later Touring models equipped with Color-Matched Hard Saddlebags.

**88232-06** **\$54.95**

Fits '93-'13 Touring models equipped with Hard Saddlebags.



A. TOUR-PAK WALL ORGANIZER – '93-'13 MODELS

### C. SADDLEBAG TOOL TETHER

A great way to bring along tools, spark plugs, and other small items, this unique Tool Tether replaces the saddlebag check strap. The hook-and-loop flaps lock the tools in place and help keep your saddlebag organized. Tools not included.

**53579-01** **\$34.95**

Fits '93-'13 Touring models equipped with Color-Matched Hard Saddlebags.



B. SADDLEBAG WALL ORGANIZER – ('14-LATER MODELS SHOWN)

### D. TRUNK DOOR ORGANIZER

For on-the-road storage and efficiency, this ingenious organizer helps keep smaller items conveniently located on your trunk door for easy access. The easy-to-install self-adhesive organizer features two large nylon-mesh pockets with hook-and-loop-secured flaps that offer quick access to keys, cell phones, glasses, gloves, and maps. Organizer features an embossed "Harley-Davidson" script logo. Add the matching Tour-Pak Lid Organizer P/N 53249-01B inside the Tour-Pak luggage for maximum organization.

**93300001** **\$59.95**

Fits '09-later FLHTCUTG and FLHXXX models.



C. SADDLEBAG TOOL TETHER

D. TRUNK DOOR ORGANIZER

*Notice: The prices appearing in this catalog are the manufacturer's suggested retail prices. Actual retail prices may vary.*



# TOURING & TRIKE 419

Luggage Accessories



**E. PREMIUM TRAVEL-PAK – KING TOUR-PAK**



**E. PREMIUM TRAVEL-PAK –  
CHOPPED TOUR-PAK**



**E. PREMIUM TRAVEL-PAK –  
HARD SADDLEBAGS**



**F. TRAVEL-PAK – '93-'13  
KING TOUR-PAK**



**F. TRAVEL-PAK –  
'94-'13 HARD SADDLEBAGS**



**F. TRAVEL-PAK – LEATHER TOUR-PAK**



**F. TRAVEL-PAK –  
LEATHER SADDLEBAGS**

## E. PREMIUM TRAVEL-PAKS

This collection of fitted luggage provides convenient storage for your next long ride. The bags are manufactured of water resistant ballistic nylon that matches the premium luggage collection. The exterior features comfortable carrying handles, heavy-duty glove-friendly zippers, a zippered pocket, D-rings for optional carrying straps. The padded interior features a variety of convenient storage pockets and plenty of open storage. Saddlebag right-hand bag features an internal padded laptop pocket and plenty of smart storage spaces.

**93300072** King Tour-Pak®. **\$99.95**

Fits '93-later Touring and Trike models equipped with King Tour-Pak luggage.

**93300071** Chopped Tour-Pak. **\$89.95**

Fits '93-later Touring and Trike models equipped with Chopped Tour-Pak luggage.

**93300070** Hard Saddlebags. **\$129.95**

Fits '93-later Touring models equipped with Hard Saddlebags. Sold in pairs.

## F. TRAVEL-PAKS

Simplify packing and unpacking your motorcycle. These well-constructed, water-resistant bags are designed to fit perfectly into Touring model luggage systems. The soft sides conform to the interior of the luggage to help use every available inch of space. Styled with a Bar & Shield logo, they feature heavy-duty zippers and convenient carrying handles.

**53605-97** King Tour-Pak. **\$59.95**

Fits '93-later Touring and Trike models equipped with King and Ultra Tour-Pak luggage.

**91783-96** Chopped Tour-Pak. (not shown) **\$54.95**

Fits '97-later Touring and Trike models equipped with Chopped Tour-Pak luggage.

**91885-97A** Hard Saddlebags. **\$59.95**

Fits '93-later Touring models equipped with Color-Matched Hard Saddlebags and '09-later VRSCF models equipped with Rigid Saddlebags P/N 91172-09. Sold in pairs.

**53621-98** Leather Tour-Pak. **\$49.95**

Fits '96-'13 XL, Softail® Touring models equipped with Leather Tour-Pak luggage.

**91887-98** Leather Saddlebags. **\$59.95**

Fits '98-later FLHRC and FLHRS models. Sold in pairs.

Notice: The prices appearing in this catalog are the manufacturer's suggested retail prices. Actual retail prices may vary.

# 420 TOURING & TRIKE

## Luggage Accessories

### A. TRUNK TRAVEL-PAKS

These well-constructed, ballistic nylon bags are designed to fit perfectly into the rear or top-load trunk of the Harley-Davidson® Trike models. Styled to compliment the Premium Luggage Collection, the twin bags feature white piping and a reflective Bar & Shield logo. The bags feature glove-friendly zippered access to the main compartment and convenient outer pouches. Comfortable carrying straps make transportation a breeze. Sold in pairs.

**53000431** **\$114.95**  
Fits '09-later FLHTCUTG, '10-'11 FLHXXX and '15-later FLRT models.



A. TRUNK TRAVEL-PAKS



A. TRUNK TRAVEL-PAKS

### B. RIDER BRIEFCASE

Commute to work in style. Leather and vinyl briefcase is designed with the rider in mind, and is sized to fit effortlessly into hard saddlebags on Touring models. The oversized handle and the non-slip shoulder strap are comfortable to carry, and glove-friendly zippers are easy to operate. The large messenger-style flap is secured with quick-release snaps concealed behind the traditional straps and buckles. When open, the interior reveals a zippered front storage pouch that features a key ring holder, secure cellphone pocket, a PDA accessory pocket, pen loops, interior zippered pocket and card holders. The main compartment features a padded laptop and tablet pocket and open storage for files and documents. Snap close side ports allow headphone and charger cable access. Size: 16.5" X 11.5" X 5.0", fits laptops up to 15.0" X 10.0" (accommodates most 17.0" screens).

**93300092** **\$249.95**  
Sized to fit Touring models equipped with Color-Matched Hard Saddlebags.



A. TRUNK TRAVEL-PAKS

### C. SADDLEBAG COOLER

Keep beverages and snacks cold right in your saddlebag on those hot summer rides. This zippered bag is fully lined and insulated, and fits the full length of your saddlebag.

**90200991** **\$69.95**  
Fits '93-later Touring models equipped with Color-Matched Hard Saddlebags.



B. RIDER BRIEFCASE



C. SADDLEBAG COOLER

*Notice: The prices appearing in this catalog are the manufacturer's suggested retail prices. Actual retail prices may vary.*



# TOURING & TRIKE 421

Paint Protection

NEW



**D. SADDLEBAG LID BRA**  
(90200992 SHOWN)



**D. SADDLEBAG LID BRA**  
(57805-03A SHOWN)

**D. SADDLEBAG LID BRA**

Protect your saddlebags from boot scuffs, stone chips and road debris. These custom-fit Saddlebag Lid Bras are made with non-abrasive, fleece-backed vinyl material and feature small Bar & Shield logos. Easy to install with hook-and-loop tabs. Kit includes left and right side Lid Bras.

**90200992** **\$89.95**

Fits '14-later Touring models with Color-Matched Hard Saddlebags. Does not fit with Saddlebag Lid Rails, Saddlebag Lid Spoilers or Saddlebag Lid Speakers.

**D. SADDLEBAG LID BRA**

Protect your Original Equipment hard saddlebags from scratches and road debris. The Saddlebag Lid Bra is made with non-abrasive, fleece-backed vinyl material and features an embroidered Bar & Shield logo. Easy to install with hook-and-loop tabs. Kit includes left and right side Lid Bra.

**57805-03A** **\$89.95**

Fits '93-'13 Touring models equipped with Color-Matched Hard Saddlebags. Does not fit with Police Model Hard Saddlebags, Saddlebag Lid Rails, Saddlebag Lid Spoilers, or Saddlebag Wing Tips.

**E. TOUR-PAK LID BRA**

Protect your Razor-Pak, Chopped or King Tour-Pak® luggage from scratches and road debris. The Tour-Pak Lid Bra is made with non-abrasive fleece-backed vinyl material and features an embroidered Bar & Shield logo. Easy to install with hook-and-loop tabs.

**57844-05** **\$99.95**

Fits '96-'13 models equipped with Razor-Pak, Chopped Tour-Pak and King Tour-Pak luggage. Does not fit with Tour-Pak Lid Racks, Tour-Pak Lid Spoilers or Tour-Pak Interior Light Kits.

**F. TRIKE REAR FENDER BRA**

Protect your Trike's rear fenders from boot scuffs and road debris. These rich black Fender Bras are constructed of non-abrasive fleece-backed smooth vinyl, and are simple to install. Featuring a prominent embossed Bar & Shield logo, these Bras are styled to coordinate with the matching Fairing Bra P/N 57800-00 and the Tour-Pak Lid Bra P/N 57844-05.

**57892-11** **\$99.95**

Fits '09-later FLHTCUTG and '10-'11 FLHXXX models. Not for use with Chrome Fender Trim Kit P/N 83812-09.

**G. SCUFF GUARDS**

Guard against heel marks and stone chips on the leading edges of the rear fender and body of your Trike model. These heavy-duty molded rubber pads are shaped to match the contour of the body, and are easy to install with the pre-applied adhesive. The ribbed surface pattern mirrors the Original Equipment footboard inserts, and offers a clean, smooth-flowing look between the footboards and body.

Fits '09-later FLHTCUTG and '10-'11 FLHXXX models.

**1. 83968-10** Body Scuff Guards. **\$29.95**

**2. 83976-10** Fender Scuff Guards. **\$39.95**



**E. TOUR-PAK LID BRA**



**F. TRIKE REAR FENDER BRA**



**G. SCUFF GUARDS — BODY & FENDER**



**G. SCUFF GUARDS — FENDER**



**G. SCUFF GUARDS — BODY**

Notice: The prices appearing in this catalog are the manufacturer's suggested retail prices. Actual retail prices may vary.

# 422 TOURING & TRIKE

## Paint Protection

### TRANSPARENT PAINT GUARD KITS

This transparent skin is designed to protect your paint from bugs, boot scuffs and road debris. The crystal-clear material protects the paint without changing the overall look of your bike. And the optical properties of the material disguise minor scuffs and scratches. The application process is similar to that of tinted window film and the material can be removed and replaced when it is no longer cosmetically appealing. Scratches to paint can be expensive to repair but scratches to this film can be removed by applying a small amount of heat with a heat gun.

#### A. SADDLEBAGS – LID

**11100098** **\$79.95**

Fits '14-later Touring models with Color-Matched Hard Saddlebags. Does not fit models with leather-covered bags, or Boom!™ Audio Speaker Lids. Not recommended for use on denim or aftermarket paint.

**11100028A** **\$79.95**

Fits '93-'13 Touring models with Color-Matched Hard Saddlebags. Does not fit models with leather-covered bags. Do not use with denim or aftermarket paint.

#### B. SADDLEBAGS – FRONT

**11100097** **\$49.95**

Fits '14-later Touring models with Color-Matched Hard Saddlebags. Does not fit models with leather-covered bags. Not recommended for use on denim or aftermarket paint.

**11100082** **\$49.95**

Fits '93-'13 Touring models with Color-Matched Hard Saddlebags. Not recommended for use on denim or aftermarket paint.

#### C. TOURING SIDE COVERS

**11100078** **\$39.95**

Fits '97-later Touring models. Not recommended for use on denim or aftermarket paint.

#### D. FRONT FENDER

**11100080** **\$39.95**

Fits Dyna® FLD, most FL Softail® (except Springer™) and Touring models. Not recommended for use on denim or aftermarket paint.

#### E. FAIRING LOWERS

**11100086** **\$49.95**

Fits '83-'13 Touring (except '98-'09 FLTR) and Trike equipped with Vented Fairing Lower. Not recommended for use on denim or aftermarket paint.



A. TRANSPARENT PAINT GUARD KITS, SADDLEBAGS – LID



A. TRANSPARENT PAINT GUARD KITS, SADDLEBAGS – LID '93-'13 MODELS



A. TRANSPARENT PAINT GUARD KITS, SADDLEBAGS – LID '14-LATER MODELS



B. TRANSPARENT PAINT GUARD KITS, SADDLEBAGS – FRONT



C. TRANSPARENT PAINT GUARD KITS – TOURING SIDE COVERS

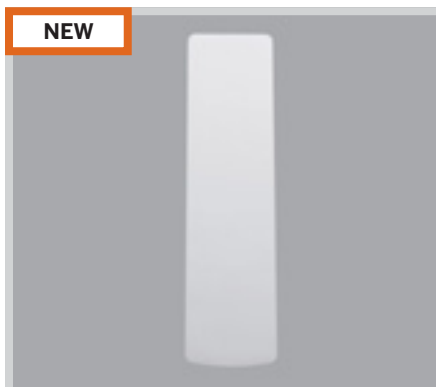

D. TRANSPARENT PAINT GUARD KITS – FRONT FENDER



E. TRANSPARENT PAINT GUARD KITS – FAIRING LOWERS

Notice: The prices appearing in this catalog are the manufacturer's suggested retail prices. Actual retail prices may vary.



# TOURING & TRIKE 423

Paint Protection

NEW



F. TRANSPARENT PAINT GUARD KIT  
(83989-10A SHOWN)



F. TRANSPARENT PAINT GUARD KIT  
(11100125 SHOWN)

## F. TRANSPARENT PAINT GUARD KIT – TRIKE

This transparent skin is designed to protect parts of the Trike bodywork from boot scuffs and road debris. The crystal-clear material protects the area surrounding the passenger foot-board and are pre-cut to fit the leading and inner surface of the rear fender, the fascia panel of the trunk and the side covers. Scratches in the material can be "healed" by applying a small amount of heat with a heat gun. The application process is similar to that of tinted window film and the material can be removed and replaced when it is no longer cosmetically appealing.

**83989-10A** **\$134.95**

Fits '09-later FLHTCUTG and '10-'11 FLHXXX models. Not recommended for use on denim or aftermarket paint.

**11100125** **\$134.95**

Fits '15-later FLRT models. Not recommended for use on denim or aftermarket paint.

## G. FAIRING BRA – BAT WING FAIRING

Offering a custom look and protection from the elements for your fairing, this Fairing Bra is made with non-abrasive, fleece-backed vinyl material and features a Bar & Shield logo. It is designed for easy installation and a custom fit.

**57000307** **\$109.95**

Fits '14-later Electra Glide®, Street Glide® and Tri Glide® models.

**57800-00** **\$109.95**

Fits '96-'13 Electra Glide, Street Glide and Trike models. Requires separate purchase of Chrome Windshield Molding P/N 59213-96.

## H. FAIRING BRA – ROAD GLIDE®

With a custom fit and an embossed Bar & Shield logo, this fleece-lined vinyl Fairing Bra protects your Road Glide® fairing from the elements with a touch of style. Designed for easy installation, this one-piece Fairing Bra helps protect your paint from stone chips and bug residue.

**57846-01** Fits '98-'13 Road Glide models. **\$124.95**

NEW



G. FAIRING BRA – BAT WING FAIRING  
(57000307 SHOWN)



G. FAIRING BRA – BAT WING FAIRING  
(57800-00 SHOWN)



H. FAIRING BRA – ROAD GLIDE

TOURING

Notice: The prices appearing in this catalog are the manufacturer's suggested retail prices. Actual retail prices may vary.

# 424 TOURING & TRIKE

## Electrical Accessories

### A. CIGARETTE LIGHTER AND SOCKET KIT

Need a light? This complete kit is designed as a direct replacement for stock fairing mounted 12V accessory outlet. Kit includes heat-resistant fairing mounted receptacle, short knob pop out lighter with weather skirt and wire connectors. Not intended to be used as an accessory power outlet.

**69200605** **\$29.95**  
Fits '14-later Touring and Tri Glide® models equipped with fairing mounted 12V accessory outlet.



**A. CIGARETTE LIGHTER AND SOCKET KIT**

### B. AUXILIARY POWER PORT

Power your cell phone, GPS, portable music player or tire inflator from this handy 12-volt power port. Conventional style power outlet accepts most 12V automotive power adaptor plugs, and features a flip-top cover to protect the port while not in use.

**69200826** **\$40.95** Tour-Pak® Mount.  
Fits '14-later FLHTCU, FLHTCUL and FLHTCUTG models. Original Equipment on FLHTK and FLHTKL.

**91671-10** **\$49.95** Tour-Pak Mount.  
Fits '96-'13 FLHTCU and '06-'13 FLHTC, FLTRU and FLHTCUTG models. Also fits '06-'13 Touring models with accessory King Tour-Pak luggage and '98-'13 Touring models with Tour-Pak mounted rear speaker pods. Not for use with Accessory Fitted Liners or Premier Liner.

**69200091** **\$40.95** Saddlebag Mount.  
Fits models equipped with 12-volt battery. Does not fit VRSC™ models, throw-over style saddlebags or swingarm bags. Not for use with accessory Fitted Liners or Premier Liner. Requires separate purchase of Battery Charging Harness P/N 94624-97B, if not already equipped.

**91843-97** **\$29.95** Side-Panel Mount.  
Fits '94-'13 Touring and Trike models.

**69201099** **\$29.95** Side-Panel Mount.  
Fits '14-later Touring and Trike models.



**B. AUXILIARY POWER PORT – TOUR-PAK MOUNT**

### C. USB CHARGING ADAPTOR

Charge your cell phone, MP3 players, and other hand-held devices while on the road. Compact Adaptor plugs into standard or accessory 12-volt power ports, and provides a standard USB-style outlet that accepts many phone and music player power cords.

**69200357** **\$19.95**  
For use with 12V Auxiliary Power Port.



**B. AUXILIARY POWER PORT – SADDLEBAG MOUNT**



**B. AUXILIARY POWER PORT – SIDE-PANEL MOUNT**

**C. USB CHARGING ADAPTOR**

*Notice: The prices appearing in this catalog are the manufacturer's suggested retail prices. Actual retail prices may vary.*



# TOURING & TRIKE 425

## Electrical Accessories



**D. 54-AMP HIGH OUTPUT CHARGING SYSTEM**

### D. 54-AMP HIGH OUTPUT CHARGING SYSTEM

The Harley-Davidson® High Output Charging System is engineered to provide 30% more power than the stock system at idle. With 54 amps of output at 4000 rpm, accessories will operate at their peak performance – no more dimming lights, reduced audio performance or under-performing heated gear. This is a recommended installation anytime a multi-amp audio system is installed on the vehicle in order to achieve the full capability of your audio system. It is also recommended when installing heated seats, heated gear and other higher draw powered accessories.

Stock on select CVO™ Touring models, the complete kit includes high performance rotor, stator, voltage regulator and all gaskets and hardware required for installation.

**29900028** **\$489.95**  
Fits '11-later Touring, '10-later CVO Touring and '09-later Trike models. Stock on '14-later FLHTKSE, FLTRUSE and FLHXSE.



**E. 45-AMP CHARGING SYSTEM FOR ELECTRA GLIDE MODELS**

### E. 45-AMP CHARGING SYSTEM FOR ELECTRA GLIDE® MODELS

Standard equipment on H-D® Touring-style Police motorcycles, this high-output charging system knows how to work for a living. Add more electronics – including lights – on your Electra Glide® model without worrying about whether you've got the juice to back it up.

**29999-97B** Fits '99-'05 FLHT models. **\$269.95**



**F. 32-AMP HIGH-OUTPUT ALTERNATOR KIT**

### F. 32-AMP HIGH-OUTPUT ALTERNATOR KIT

Stock on all '89-later carbureted 1340 models. 50% increase in amperage for the heavily accessorized motorcycle.

**29985-87** **\$249.95**  
Fits '84-'88 FLT, FLHT, and FXR (wet clutch) models. (Will not fit '84-'88 Softail®.) Stock on all '89-'95 and some '96-'97 Evolution® 1340-equipped models.



**NEW**

**G. AUXILIARY POWER SWITCH KIT – FAIRING MOUNT (71400106 SHOWN)**

### G. AUXILIARY POWER SWITCH KIT – FAIRING MOUNT

Styled to match the Original Equipment fairing dash panel switches. These Auxiliary Power switches allow you to control additional fog lamps, auxiliary lighting, heated gear or electrical accessories with the touch of a finger. Kit includes two auxiliary switches, wire harnesses and installation hardware.

**71400106** **\$79.95**  
Fits '14-later Electra Glide and Tri Glide® models.



**NEW**

### H. ELECTRICAL CONNECTION UPDATE KIT – TOURING

Harness plugs into accessory connector to provide 12-volt power leads. Required to install Heated Grips, XM Radio, Cruiser Amp & Speaker Systems, zūmo® GPS, Digital Oil Pressure Gauge, Garage Door Opener Kits, Heated Seats and decorative lighting on '14-later Touring and Trike models.

**69200722** **\$23.95**  
Fits '14-later Touring and Trike models.

### I. SWITCHED CIRCUIT ADAPTER HARNESS

This harness allows two accessories to be connected to the switched accessory circuit featured on '94-later Touring models. You then may switch two accessories on or off simultaneously as required.

**70264-94A** **\$19.95**  
Fits '94-later Touring and Trike models. Required on '14-later Touring and Trike models when connecting multiple powered accessories using Electrical Connection Kit P/N 69200722.



**H. ELECTRICAL CONNECTION UPDATE KIT – TOURING**



**70264-94A**

**70270-04**

**I. SWITCHED CIRCUIT ADAPTER HARNESS & ELECTRICAL ACCESSORY ADAPTER**

#### Also available:

#### ELECTRICAL ACCESSORY ADAPTER

Harness accommodates the addition of multiple electrical accessories to the main battery power circuit on specified models.

**70270-04** **\$15.95**  
Fits '04-'13 XL, XR and Touring and Trike models. Also fits '07-later VRSC™, '04-'11 Dyna® and '04-'10 Softail® models.

*Notice: The prices appearing in this catalog are the manufacturer's suggested retail prices. Actual retail prices may vary.*

# NEVER IN A TIGHT SPOT

On the road, you've got to feel good in the saddle. Whether you're cruising around town or out for the long haul, your bike should welcome you like an old friend and feel like an extension of yourself. So, once you've picked the bike, it's time to choose the suspension that best equips your ride to your personal dimensions.



## A STRONG FOUNDATION



Being sure-footed at a stop or when parking your bike enhances your feelings of control and confidence. Adjusting the ride height by lowering the suspension may be the first step in fitting the bike to your inseam length. Combining a low-profile suspension and a narrow seat is the easiest way for a shorter rider to fit comfortably on a larger bike.

### THE FIT SHOP LIST



Here are a few options to consider when outfitting your bike to fit you. Find your model and flip to the pages for more information. For more details, visit [h-d.com/fitshop](http://h-d.com/fitshop).

2015	SUSPENSION	SEATS	HANDLEBARS	FOOT SUPPORTS
FLHR FLHRC	Premium Ride Low Front Suspension Premium Ride Low Rear Suspension Profile® Low Rear Suspension	Super Reduced Reach® Seat Reduced Reach Seat Brawler®/Sidekick® Seat Badlander® Seat Low-Profile Bucket Seat Tallboy® Seat Sundowner™ Seat Harley Hammock® Seat Road Zeppelin® Seat	12" & 16" Fat Ape Road King® Fat Bar Reduced Reach Bar Tallboy Bar	Adjustable Highway Pegs Extended Shift Levers Extended Reach Rider Footboards Adjustable Passenger Footboards & Pegs
FLHTCU FLHTK	Premium Ride Low Front Suspension Premium Ride Low Rear Suspension Profile Low Rear Suspension	Super Reduced Reach Seat Reduced Reach Seat Brawler / Sidekick Seat Badlander Seat Low-Profile Bucket Seat Tallboy Seat Sundowner Seat Harley Hammock Seat Road Zeppelin Seat	Bat Wing Mini-Ape Reduced Reach Bar Tallboy Bar	Adjustable Highway Pegs Extended Shift Levers Extended Reach Rider Footboards Adjustable Passenger Footboards & Pegs
FLHX FLTRXS	Premium Ride Low Front Suspension	Super Reduced Reach Seat Reduced Reach Seat Brawler / Sidekick Seat Badlander Seat Low-Profile Bucket Seat Tallboy Seat Sundowner Seat Harley Hammock Seat Road Zeppelin Seat	Bat Wing Mini-Ape Reduced Reach Bar Tallboy Bar	Adjustable Highway Pegs Extended Shift Levers Extended Reach Rider Footboards Adjustable Passenger Footboards & Pegs
FLTRX FLHXS	Premium Ride Low Front Suspension	Super Reduced Reach Seat Reduced Reach Seat Brawler / Sidekick Seat Badlander Seat Low-Profile Bucket Seat Tallboy Seat Sundowner Seat Harley Hammock Seat Road Zeppelin Seat	Road Glide® Bar	Adjustable Highway Pegs Extended Shift Levers Extended Reach Rider Footboards Adjustable Passenger Footboards & Pegs
FLRT (Freewheeler™)	-	Reduced Reach Seat Sundowner Seat	Tallboy Bar	Adjustable Highway Pegs Extended Shift Levers Extended Reach Rider Footboards
FLHTCUTG (Tri Glide®)	-	Super Reduced Reach Seat Reduced Reach Seat Tallboy Seat	Bat Wing Mini-Ape Reduced Reach Bar Tallboy Bar	Adjustable Highway Pegs Extended Shift Levers Extended Reach Rider Footboards



# TOURING & TRIKE 427

## Suspension



**A. PREMIUM RIDE SINGLE CARTRIDGE FORK KIT**



**B. PREMIUM RIDE DOUBLE CARTRIDGE FORK KIT**



**C. PREMIUM RIDE CARTRIDGE STYLE FRONT END LOWERING KIT (54599-02 SHOWN)**



**D. PROFILE LOW TOURING FRONT LOWERING KIT (54564-09 SHOWN)**



**D. PROFILE LOW TOURING FRONT LOWERING KIT (46875-09 SHOWN)**



**D. PROFILE LOW TOURING FRONT LOWERING KIT (54614-05 SHOWN)**

### A. PREMIUM RIDE SINGLE CARTRIDGE FORK KIT<sup>1</sup>

This Cartridge Fork Kit converts the standard Original Equipment front suspension into a high-performance suspension with superior ride quality. The Cartridge Fork Kit complements the Premium Ride Hand-Adjustable Rear Shocks (Low-Profile and Standard-Height) by providing a balanced suspension system capable of delivering superior ride characteristics. The front fork kit improves resistance to front brake dive, improves cornering and enhances bottoming control. A perfect addition during the installation of chrome or gloss black lower fork sliders, the kit includes fork pipes, cartridges, fork bolts, main springs and oil seals. Available in Standard Ride Height and Low Ride Height versions.

**45500158** Standard-Height. **\$349.95**  
Fits '14-later Touring models. Does not fit Trike models.

**45500157** Low-Profile. **\$349.95**  
Fits '14-later Touring models. Does not fit Trike models. Stock on '15-later FLHTKL and FLHTCUL models. Must only be installed on vehicles equipped with lowered rear shocks.

### B. PREMIUM RIDE DOUBLE CARTRIDGE FORK KIT<sup>1</sup>

This Double Cartridge Fork Kit converts the standard Original Equipment front suspension into a high-performance suspension with superior ride quality. The Double Cartridge Fork Kit complements the Premium Ride Hand-Adjustable Rear Shocks (Low-Profile and Standard-Height) by providing a balanced suspension system capable of delivering superior ride characteristics. The front fork kit improves resistance to front brake dive, improves cornering and enhances bottoming control. A perfect addition during the installation of chrome or gloss black lower fork sliders, the kit includes fork pipes, cartridges, fork bolts, main springs and oil seals.

**45500106** **\$429.95**  
Fits '09-'13 Touring models. Does not fit Trike models.

### C. PREMIUM RIDE CARTRIDGE STYLE FRONT END LOWERING KIT<sup>1</sup>

A complete kit designed to lower the front end of your Touring bike by approximately 1.0". A great accessory to add when installing your Chrome or Gloss Black Lower Fork Sliders. Must only be installed on vehicles equipped with Profile Low Touring Shocks P/N 54631-02B.

**54599-02** Fits '02-'08 Road King® models. **\$199.95**

**54598-02** **\$139.95**  
Fits '02-'05 Touring models (except Road King).

### D. PROFILE® LOW TOURING FRONT LOWERING KIT<sup>1,2</sup>

Place the rider's feet firmly on the ground. This kit utilizes components designed to provide a 1.0" decrease in ride height.

**54564-09** **\$159.95**

Fits '09-'13 Touring models (except FLHR, FLHRC, FLTRSE3, FLTRXSE/2, FLHRSE5, FLHXSE/2/3, FLHP and FLHPE models). Does not fit Trike models. Must only be installed on vehicles equipped with Profile® Low Touring Shocks P/N 54635-09 or Premium Ride Low Shocks P/N 54680-10. Can be installed on FLHX and FLTRX models with Original Equipment rear shocks.

**46875-09** **\$159.95**

Fits '09-'13 Road King models. Must only be installed on vehicles equipped with Profile Low Touring Shocks P/N 54635-09.

**54614-05** **\$104.95**

Fits '02-'08 Road King models. Must only be installed on vehicles equipped with Profile Low Touring Shocks P/N 54631-02B.

**54628-06** **\$104.95**

Fits '06-'08 Touring models (except Road King or FLH Police models). Must only be installed on vehicles equipped with Profile Low Touring Shocks P/N 54631-02B. Can be installed on FLHX models with Original Equipment rear shocks.



<sup>1</sup>**WARNING:** Installation of any accessory suspension components may affect cornering clearance and jiffy stand operation. This could distract the rider, causing loss of control and death or serious injury.



<sup>2</sup>**WARNING:** The Profile Low Front Spring Kit cannot be used independently and must be used with the appropriate Profile Rear Shock Lowering Kit. Installation of any accessory suspension components may affect cornering clearance and jiffy stand operation. This could distract the rider, causing loss of control and death or serious injury.

Notice: The prices appearing in this catalog are the manufacturer's suggested retail prices. Actual retail prices may vary.

## 428 TOURING & TRIKE

### Suspension

#### A. PREMIUM RIDE HAND-ADJUSTABLE TOURING SHOCKS\*

Experience the ultimate in superior ride quality with these Premium Touring Shocks. These shocks utilize a single tube, nitrogen charged emulsion design. The design offers enhanced compression and rebound damping compared to the Original Equipment-style air adjustable shocks. This provides a controlled yet plush ride with much less bottoming. Larger chambers (40mm diameter pistons and 14mm rods) allow these shocks to react more quickly to impacts. This keeps the tires tracking while minimizing harshness transmitted through the frame. A simple knob behind the left saddlebag allows the rider to conveniently modify the spring preload via a hydraulic adjuster. Available in Standard Ride Height and Low Ride Height versions.

**54000091** Low-Profile. **\$549.95**  
Fits '09-later Touring models. Does not lower '09-later FLHX, FLTRX, and FLTRSE3 models. Stock on FLHRSE5, FLHXSE/2/3, FLTRXSE/2, FLHXS, FLHXSE, FLHTKL, FLHTCUL, and FLTRXS models. Does not fit Trike models.

**54000008** Standard-Height. **\$549.95**  
Fits '09-later Touring models (except models equipped with Front Lowering Kits).



A. PREMIUM RIDE HAND-ADJUSTABLE TOURING SHOCKS



A. PREMIUM RIDE HAND-ADJUSTABLE TOURING SHOCKS



**\*WARNING:** Installation of any accessory suspension components may affect cornering clearance and jiffy stand operation. This could distract the rider, causing loss of control and death or serious injury.

*Notice: The prices appearing in this catalog are the manufacturer's suggested retail prices. Actual retail prices may vary.*



# TOURING & TRIKE 429

Suspension



**B. PROFILE LOW TOURING SHOCKS**

## **B. PROFILE® LOW TOURING SHOCKS\***

Lower the seat height of your Touring model without compromising the ride. The Profile® Low Touring Shocks have been re-valved for a comfortable ride while lowering the seat height by up to .75". The kit maintains the air adjustability feature of the stock shocks.

**54635-09** **\$299.95**

Fits '09-later Touring models. Does not lower '09-later FLHX, FLXS, FLTRX, FLTRXS, FLHTKL, FLHTCUL, FLHRSE5, FLHXSE/2/3, FLTRXSE/2 and FLTRSE3 models. Does not fit Trike models.

**54631-02B** **\$339.95**

Fits '97-'08 Touring models (except FLHRSE3/4). Does not lower FLHRS or FLHX models.

## **TOURING SUSPENSION AIR PUMPS**

This pump was designed to allow safe and simple adjustment of the front and rear air suspension on Touring motorcycles. Unlike a bicycle pump or a fuel station air hose, the hand-operated pump with controllable "micro bleed" valve allows precise adjustment to air volume, and the "no loss" air connector maintains shock pressure when the fitting is removed. The swivel air hose simplifies valve stem attachment.

## **C. ANALOG TOURING SUSPENSION AIR PUMP**

Aluminum housing is compact, lightweight, and durable, and fits easily into your bag for "on-the-road" adjustments. The high-quality 0-60 psi gauge ensures accurate air pressure.

**54630-03A** **\$49.95**

For use with Touring air suspension components.

## **D. DIGITAL TOURING SUSPENSION AIR PUMP**

Display units can easily be changed between PSI and KPa. The LCD readout operates on a long-lasting, replaceable lithium coin-type battery (CR2032 3V, P/N 66000107).

**54000033** **\$69.95**

For use with Touring air suspension components.



**C. ANALOG TOURING SUSPENSION AIR PUMP**



**D. DIGITAL TOURING SUSPENSION AIR PUMP**



**\*WARNING:** Installation of any accessory suspension components may affect cornering clearance and jiffy stand operation. This could distract the rider, causing loss of control and death or serious injury.

Notice: The prices appearing in this catalog are the manufacturer's suggested retail prices. Actual retail prices may vary.

# 430 TOURING & TRIKE

## Foot Controls

### A. EXTENDED REACH RIDER FOOTBOARD PANS

This kit extends the rider footboard forward of the stock location by one inch, providing the tall rider a comfortable riding position. When paired with Extended Reach Brake and Shift Levers, these pans allow riders with large boot sizes ample room to reposition their feet during a long ride. Available in traditional D-shape or Swept Wing design, Extended Reach footboard pans accept Original Equipment or accessory rider footboard inserts. The kit includes left and right footboard pans.

Fits '02-later Touring and Trike models (except FLHTKL and FLHTCUL). Also fits '97-'01 Touring models equipped with Extended Reach Billet Style Brake Lever P/N 42638-03.

<b>50409-04</b>	Traditional Shape.	<b>\$89.95</b>
<b>54145-10</b>	Swept Wing.	<b>\$89.95</b>

### B. EXTENDED LENGTH RIDER RUNNING BOARDS

Stretching your legs and moving your feet during a long ride relieves muscle tension and reduces rider fatigue. At 4.0" longer (1.0" in front, 3.0" in back) and .5" wider than the Original Equipment rider footboards, these ergonomically friendly running boards provide plenty of space for riders to reposition their feet for maximum comfort. When used in conjunction with available Extended Brake and Shift Levers, the long legged rider will have even more room to stretch out on long rides. The easy-to-install kit includes left and right footboard pans with vibration-isolated inserts that are styled to complement the Crested Bar & Shield controls collection, or most other chrome and rubber collections.

<b>50500158</b>	Chrome.	<b>\$199.95</b>
Fits '00-later FL Softail® (except FLS, FLSTFB, FLSTN, FLSTNSE, and FLSTSE/2/3, '08-later Touring (except FLHTKL and FLHTCUL) and '09-'13 Trike models. Not for use with Jiffy Stand Kit P/N 5000000 or Jiffy Stand Extension Kit P/N 50233-00, 50000008 and 50000023.		

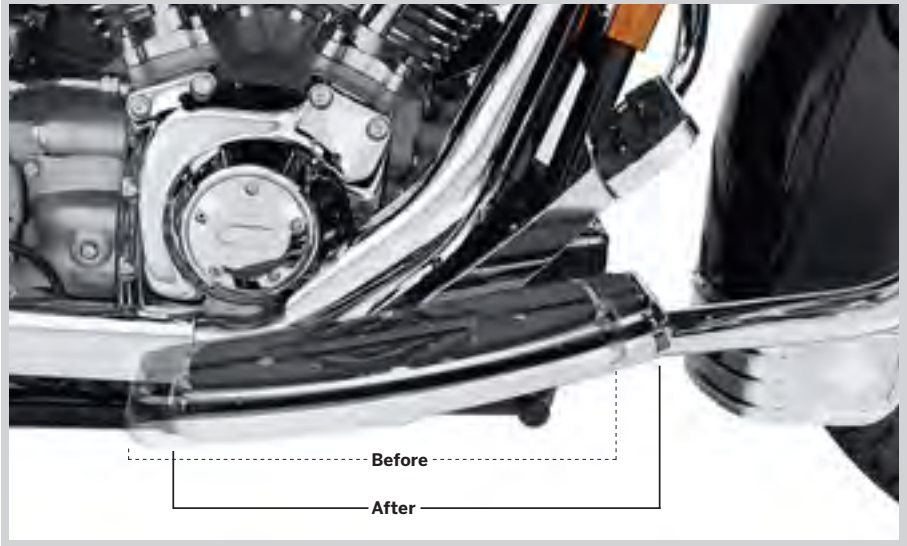

A. EXTENDED REACH RIDER FOOTBOARD PANS – TRADITIONAL SHAPE

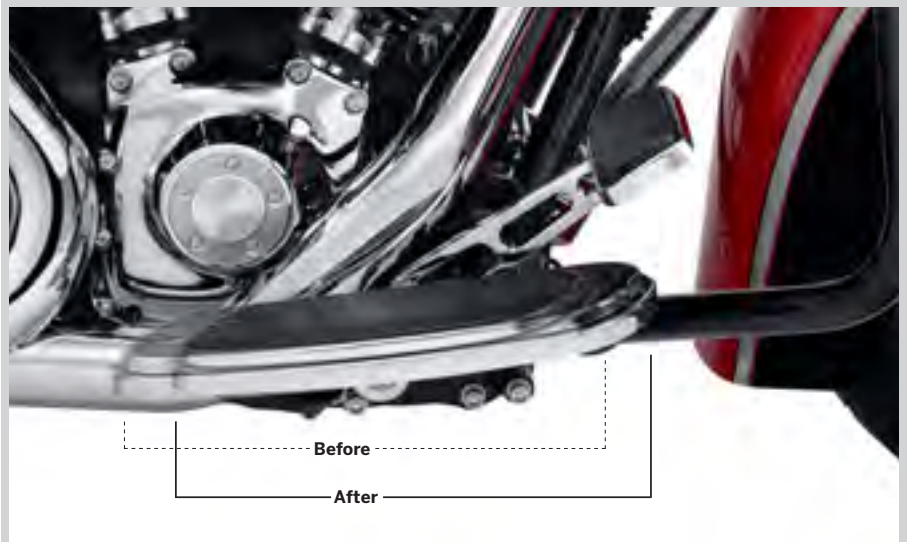

A. EXTENDED REACH RIDER FOOTBOARD PANS – SWEEP WING



B. EXTENDED LENGTH RIDER RUNNING BOARDS

Notice: The prices appearing in this catalog are the manufacturer's suggested retail prices. Actual retail prices may vary.





**C. BILLET STYLE BRAKE LEVER – EXTENDED REACH**



**C. EXTENDED BRAKE LEVER – COMPARISON TO STOCK LENGTH**



**D. BILLET STYLE HEEL/TOE SHIFT LEVER – EXTENDED REACH**

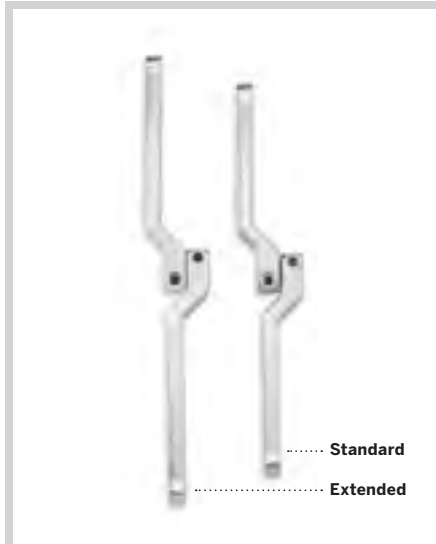

**D. EXTENDED HEEL/TOE SHIFT LEVER – COMPARISON TO STOCK**



**E. JIFFY STAND EXTENSION**

### C. BILLET STYLE BRAKE LEVER – EXTENDED REACH

Ride tall in the saddle. This billet style Brake Lever features a 1.0" longer arm than the Original Equipment brake lever, allowing tall riders to stretch their legs and straighten their knees for added comfort and control. The additional room also provides riders with large boot sizes ample room to move and reposition their feet on the footboard. Styled to complement our billet style mirror stems, these Billet Style Brake Levers are forged, machined and polished for a beautiful, custom look. When combined with the available Extended Reach Shift Lever, long-limbed riders can straighten their legs and ride in comfort. Brake pedal pads sold separately.

**41600012** Chrome. **\$169.95**  
Fits '08-'13 Touring models (except FLHTCU, FLHTK, FLTRU and models equipped with fairing lowers).

**42638-03** Chrome. **\$169.95**  
Fits '97-'07 Touring models.

### D. BILLET STYLE HEEL/TOE SHIFT LEVER – EXTENDED REACH

Stretch out in style. Both the heel and toe sections of this Shift Lever are 1.0" longer than traditional levers, separating the distance between the heel/toe shift by 2.0" total. This added space provides a comfortable riding position for a tall rider, and allows a rider with a large boot extra room to move. Styled to complement our billet style mirror stems, these Billet Style Shift Levers are forged, machined and polished for a beautiful, custom look. When combined with the available Extended Reach Brake Lever, long-limbed riders can straighten their legs and ride in comfort. Kit includes a front and rear lever and mounting hardware.

**33600001** Chrome. **\$149.95**  
Fits '86-later FL Softail®, '88-later Touring and Trike models.

### E. JIFFY STAND EXTENSION

Jiffy Stand Extension Kits have been ergonomically designed to simplify the deployment and retraction of the jiffy stand. The extension is shaped to simplify locating the tab with your boot, and aid in swinging the jiffy stand into position. The move feels natural, and adds confidence when parking your motorcycle in a tight spot. Kit mounts to Original Equipment jiffy stand, and includes all required mounting hardware.

**50000023** **\$39.95**  
Fits '91-later Touring models.

# 432 TOURING & TRIKE

## Foot Controls

### A. BILLET STYLE REAR BRAKE LEVER

Styled to complement our billet style mirror stems and shift levers, these Billet Style Rear Brake Levers are forged from billet aluminum, then machined and polished for a beautiful, custom look. Available in your choice of finishes. Lever matches the length of the Original Equipment brake lever. Brake pedal pads sold separately.

Fits '14-later Touring and Trike models.

<b>41600079</b>	Edge Cut.	<b>\$174.95</b>
<b>41600082</b>	Chrome.	<b>\$174.95</b>

Fits '08-'13 Touring and Trike models.

<b>42638-08A</b>	Chrome.	<b>\$169.95</b>
<b>40091-10</b>	Edge Cut.	<b>\$169.95</b>
<b>46883-09</b>	Satin Black.	<b>\$169.95</b>

Fits '97-'07 Touring models.

<b>42638-00A</b>	Chrome.	<b>\$169.95</b>
------------------	---------	-----------------

### B. RIDER FOOTBOARD HEEL GUARD

Avoid damaged boots and hours of cleaning melted rubber scuff marks from your exhaust shield. This Heel Guard mounts to the right-side rider footboard and protects your boot from contact with the hot exhaust shield. The subtle curved shape keeps the boot heel away without restricting fore-and-aft movement of the rider's foot. Kit includes chrome guard with cutaway Bar & Shield logo and all mounting hardware.

**50500225** **\$64.95**

Fits '12-later Dyna® FLD, '86-later FL Softail®, '86-later Touring and '09-later Trike models equipped with Traditional and Swept Wing footboards. Does not fit models equipped with Half-Moon, Tapered or Burst footboards, Extended Reach Rider Footboards P/N 50409-04 or 54145-10, Rider Running Boards P/N 50500158 or Screamin' Eagle® Fat Exhaust Shield Kits.



A. BILLET STYLE REAR BRAKE LEVER – CHROME



A. BILLET STYLE REAR BRAKE LEVER – EDGE CUT



A. BILLET STYLE REAR BRAKE LEVER – SATIN BLACK



B. RIDER FOOTBOARD HEEL GUARD



B. RIDER FOOTBOARD HEEL GUARD

Notice: The prices appearing in this catalog are the manufacturer's suggested retail prices. Actual retail prices may vary.



# TOURING & TRIKE 433

## Foot Controls



**C. BILLET STYLE HEEL/TOE SHIFT LEVER – CHROME**

### C. BILLET STYLE HEEL/TOE SHIFT LEVER

Styled to complement our billet style mirror stems, these Billet Style Shift Levers are forged from 7075-T6 aluminum, then machined and polished for a beautiful, custom look. Available in your choice of mirror-chrome, satin black powder coat, or edge cut black anodized and machined aluminum finishes. Kit includes a front and rear lever and chrome hardware.

Fits '86-later FL Softail®, '88-later Touring and Trike models.

<b>34535-00B</b>	Chrome.	<b>\$149.95</b>
<b>34045-10</b>	Edge Cut.	<b>\$149.95</b>
<b>34023-08</b>	Satin Black.	<b>\$149.95</b>

### D. FOLDING HEEL SHIFTER

Give your left foot a little extra room. Folding Heel Shifter permits the rider to move the rear shift peg out of the way when on the open road, while retaining heel/toe shift functionality around town. Positive detent holds the peg in the selected position, and can be adjusted while riding. Easy to install, the replacement rear lever is chrome-plated, and shaped to match the Original Equipment toe shift lever. Lever accepts stock or accessory shifter peg.

**33876-07** **\$79.95**

Fits '86-later FL Softail, '88-later Touring and Trike models.

### E. HEEL/TOE SHIFTER SHAFT COVER

Conceal the splined end of the shifter shaft when you remove the heel shift lever. The easy-to-install chrome-plated aluminum billet cap is held in place with a flush Allen® screw for a clean look.

**35471-05** **\$18.95**

Fits '82-later FL Softail, Touring and Trike models equipped with heel/toe shift levers. Installation requires removal of heel shift lever.

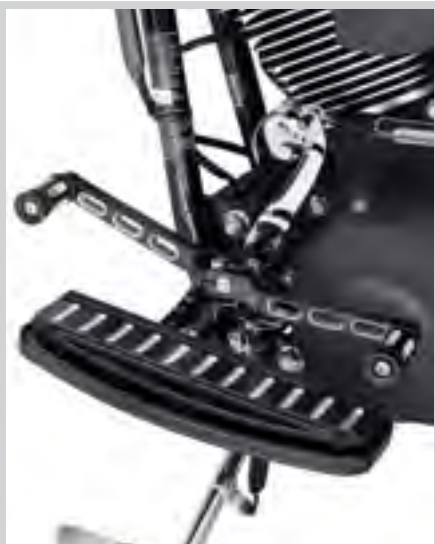

**C. BILLET STYLE HEEL/TOE SHIFT LEVER –  
EDGE CUT**



**C. BILLET STYLE HEEL/TOE SHIFT LEVER –  
SATIN BLACK**



**D. FOLDING HEEL SHIFTER –  
RETRACTED POSITION**



**E. HEEL/TOE SHIFTER SHAFT COVER**

*Notice: The prices appearing in this catalog are the manufacturer's suggested retail prices. Actual retail prices may vary.*

# 434 TOURING & TRIKE

## Foot Controls

### A. CUSTOM GEAR SHIFT LINKAGES

Kick your custom into gear with this collection of high-quality Custom Shift Linkages. Available in a variety of designs to match your bike's style, these aluminum linkages feature aircraft-quality rod ends for easy adjustment and smooth operation. The easy-to-install linkage kit includes a transmission lever cover and decorative acorn nuts and bolts for a complete custom look.

Fits '86-later Softail®, Touring and Trike models. (Does not fit '97-'99 FLSTS models or models equipped with Softail Extended Reach Forward Controls.)

<b>1. 33900134</b>	Silencer Brushed Nickel.	<b>\$129.95</b>
<b>2. 33857-09</b>	FLHX Black Anodized.	<b>\$129.95</b>
<b>3. 33915-09</b>	Diamond Black.	<b>\$129.95</b>
<b>4. 34018-08</b>	Slotted – Black Anodized.	<b>\$129.95</b>
<b>5. 34850-09</b>	Skull.	<b>\$129.95</b>
<b>6. 33851-09</b>	Road King® Scripted.	<b>\$129.95</b>
<b>7. 33840-09</b>	Flame.	<b>\$149.95</b>
<b>8. 33801-09</b>	Harley-Davidson Scripted.	<b>\$129.95</b>
<b>9. 33762-09</b>	Ball-Milled with Bar & Shield Logo.	<b>\$129.95</b>
<b>10. 33760-09</b>	Slotted with Bar & Shield Logo.	<b>\$129.95</b>
<b>11. 33884-09</b>	Smooth with Bar & Shield Logo.	<b>\$109.95</b>
<b>12. 33823-09</b>	Tribal.	<b>\$149.95</b>
<b>13. 33814-98A</b>	Round.	<b>\$89.95</b>

### B. GEAR SHIFT LINKAGE COVERS

A simple and inexpensive way to detail your Touring bike. These easy-to-install chrome-plated covers conceal the stock gear shifter linkage for a brilliant finish. Kit includes all necessary mounting hardware.

Fits '99-later Touring and Trike models with stock gear shift linkage.

<b>1. 46301-01</b>	Diamond.	<b>\$47.95</b>
<b>2. 46303-01</b>	"Harley-Davidson" Script.	<b>\$42.95</b>
<b>3. 46305-01</b>	Engraved "Harley-Davidson".	<b>\$42.95</b>



A. CUSTOM GEAR SHIFT LINKAGES



B. GEAR SHIFT LINKAGE COVERS

Notice: The prices appearing in this catalog are the manufacturer's suggested retail prices. Actual retail prices may vary.



# TOURING & TRIKE 435

## Foot Controls



**C. REAR MASTER CYLINDER COVER – CHROME (46463-08 SHOWN)**



**C. REAR MASTER CYLINDER COVER – CHROME**



**D. REAR MASTER CYLINDER KIT – CHROME**



**E. JIFFY STAND BRACKET COVER – CHROME**



**F. BLACK RIDER FOOTBOARD PANS – TRADITIONAL SHAPE**



**F. BLACK RIDER FOOTBOARD PANS – SWEEP WING SHAPE**



**G. STREAMLINER RIDER FOOTBOARD KIT**



**H. STREAMLINER PASSENGER FOOTBOARD AND MOUNT KIT**

### C. REAR MASTER CYLINDER COVER – CHROME

An easy way to add chrome to your bike is with this chrome-plated version of the stock master cylinder cover.

**46463-08** **\$59.95**  
Fits '08-later Touring models.

**46425-05A** **\$39.95**  
Fits '06-later Dyna® non-ABS models, Softail® and '05-'07 Touring models.

**45149-99C** **\$39.95**  
Fit '00-'05 Softail and '99-'04 Touring models.

### D. REAR MASTER CYLINDER KIT – CHROME

Dress your foot controls in brilliant chrome. This kit replaces the black painted rear master cylinder with a polished and plated version, manufactured from Original Equipment components for proper fit and function. The kit includes the mirror-finish master cylinder body, matching chrome master cylinder cover and polished cover hardware.

**41777-05A** **\$169.95**  
Fits '06-later Softail and '05-'07 Touring models.

**41775-04B** **\$169.95**  
Fits '00-'05 Softail and '99-'04 Touring models.

### E. JIFFY STAND BRACKET COVER – CHROME

Chrome-plated cover conceals the black jiffy stand bracket for a cleaner appearance. Works with fairing lowers. No hardware required.

**50251-01** **\$41.95**  
Fits '96-'07 Touring models.

### F. BLACK RIDER FOOTBOARD PANS

Complete the blacked-out transformation. Replace the Original Equipment chrome footboard pans with sinister gloss black. Kit includes both the right and left pan, and is installed using the Original Equipment hardware and insert pad. Custom footboard inserts are sold separately.

Fits '12-later Dyna FLD, '86-later FL Softail (except FLS and FLSTFB), Touring and Trike models (except FLHTKL and FLHTCUL).

**51322-08** **\$89.95**  
Traditional Shape.

**51060-08** **\$89.95**  
Swept Wing Shape.

### G. STREAMLINER RIDER FOOTBOARD KIT

Add the sleek sweeping footboard design from the Street Glide® to your Touring bike. Kit includes vibration-isolation footboard pads with three chrome bands, and the complete chrome-plated pans that easily bolt in place of the Original Equipment footboards.

**50631-04** **\$229.95**

Fits '12-later Dyna FLD, '86-later FL Softail (except FLS and FLSTFB), Touring and Trike models (except FLHTKL and FLHTCUL).

### H. STREAMLINER PASSENGER FOOTBOARD AND MOUNT KIT

Styled to match the rider footboards on the Road King® Custom, Road Glide® Custom and Street Glide® models, these Swept Wing Passenger Footboards feature a Streamliner-style rubber pad surrounded by a chrome accent. The smooth Swept Wing footboard pan is chrome-plated throughout to add a custom touch, even in the folded position. Designed for convenient bolt-on installation, the complete kit includes chrome-plated aluminum footboards, rubber pads, mounting hardware and passenger footboard supports.

**50378-07B** **\$389.95**

Fits '93-later Touring models.

*Notice: The prices appearing in this catalog are the manufacturer's suggested retail prices. Actual retail prices may vary.*

# 436 TOURING & TRIKE

## Passenger Footboards

### A. ADJUSTABLE PASSENGER FOOTBOARD MOUNT KIT

Maximize your passenger's riding comfort. These chrome 5-position adjustable mounts raise and lower the passenger footboard. The lowest position is 2.0" forward from stock, and the highest position is 2.5" higher than stock. Easy to adjust with a common hex wrench. Kit includes left and right adjustable support assembly and all required mounting hardware. Footboard pans and inserts sold separately.

**50768-07** **\$379.95**

Fits '93-later Touring models. Does not fit Trike models.



A. ADJUSTABLE PASSENGER FOOTBOARD MOUNT KIT

### B. PASSENGER FOOTBOARD AND MOUNT KIT

Convenient bolt-on installation. Includes specially designed mounting stud/brackets for proper installation. Footboards fold up when not in use. Kit includes Original Equipment-style aluminum footboards, rubber pads, mounting hardware and passenger footboard supports.

**50379-07B** **\$144.95**

Fits '93-later Touring and Trike models.



A. ADJUSTABLE PASSENGER FOOTBOARD MOUNT KIT

B. PASSENGER FOOTBOARD AND MOUNT KIT

### C. PASSENGER FOOTBOARD SUPPORTS – BLACK

Add the comfort and convenience of passenger footboards to your Touring motorcycle. These supports are designed to allow installation of traditional D-shaped, Swept Wing, Tapered or Old-Style Passenger Footboards (sold separately) on Touring models. Kit includes left and right supports and installation hardware. Add your choice of passenger footboard pan design and footboard insert to complete your custom look.

**50500042** **\$104.95**

Fits '93-later Touring and Trike models.



A. ADJUSTABLE PASSENGER FOOTBOARD MOUNT KIT

B. PASSENGER FOOTBOARD AND MOUNT KIT

### D. PASSENGER FOOTBOARD SUPPORTS – CHROME

Polished and plated to a mirror finish, this chrome version of the Original Equipment black passenger footboard support adds a custom touch and complements accessory floorboard inserts and covers. Kit includes left and right support, and reuses stock hardware for installation.

**53070-00A** **\$139.95**

Fits '93-later Touring and Trike models.



C. PASSENGER FOOTBOARD SUPPORTS – BLACK

D. PASSENGER FOOTBOARD SUPPORTS – CHROME

### E. REDUCED REACH PASSENGER FOOTBOARD MOUNT KIT

Kit raises the height of your passenger footboards by approximately 2.25" for increased passenger comfort. Especially desirable on '97-later Touring models due to the frame and saddlebag guard change.

**50789-99B** **\$129.95**

Fits '93-later Touring models. Does not fit Trike models. Does not fit with saddlebag guard bags.

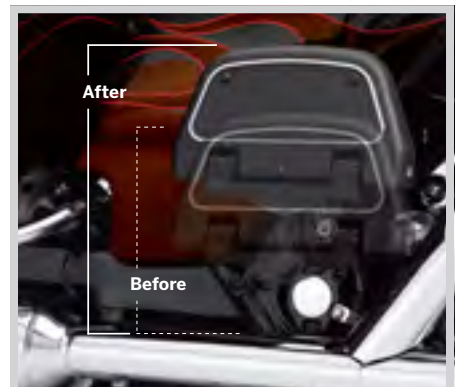

E. REDUCED REACH PASSENGER FOOTBOARD MOUNT KIT

Notice: The prices appearing in this catalog are the manufacturer's suggested retail prices. Actual retail prices may vary.



# TOURING & TRIKE 437

Passenger Footboards



F. ADJUSTABLE AUXILIARY PASSENGER FOOTPEG MOUNTS

## F. ADJUSTABLE AUXILIARY PASSENGER FOOTPEG MOUNTS

These 3-position adjustable passenger footpeg mounts will keep your companion happy over the long haul. Push-button adjustment lets the passenger reposition their feet to keep blood flowing in all the lower extremities. When combined with the standard footboard, both short and long-limbed passengers should be able to find a comfortable riding position. Pegs can also be pivoted fully rearward to allow the rider the room to get his or her feet on the ground when walking the bike in and out of parking spaces. Kit includes beautifully chromed left- and right-side adjustable mounts and all installation hardware. Complete the custom look with your choice of footpegs (sold separately).

**54157-10**

**\$239.95**

Fits '10-later Touring models with Original Equipment passenger footboards (except CVO™ models or models equipped with Adjustable Passenger Footboard Mount Kit P/N 50768-07). Also fits '93-later Touring models equipped with Passenger Footboard Kit P/N 50378-07B, 50379-07B or 53070-00A. Does not fit Trike models or models equipped with sidecars. Will not fit with Footpeg P/N 49117-77TB, 49110-98, 91821-85, 50643-82, 50647-82, 49500-92T, 49234-98, 50978-99, 50976-99, 50911-08, 50113-10, 50695-08, 49128-82, 50056-10, 50039-10, 49312-10, 50451-09 and 50178-09.



F. ADJUSTABLE AUXILIARY PASSENGER FOOTPEG MOUNTS

## G. ADJUSTABLE PASSENGER FOOTPEG MOUNT KIT

Maximize your passenger's riding comfort. Proper foot position reduces the cramped or stretched-out feeling, and relieves pressure on the knees and the tailbone. These adjustable mounts raise and lower the passenger footpeg to accommodate taller and shorter passengers. Easy to adjust with common tools, the mount adjusts through a 360° range (depending on model), allowing both fore and aft and up and down height adjustment. Kit includes left and right adjustable support assembly and all required mounting hardware. Footpegs sold separately.

**50763-09**

**\$149.95**

Fits models with H-D® male mount-style passenger footpeg supports (except Softail® models). Does not fit with Heel Raiser Footpeg Kit P/N 50178-09. Does not fit the rider position.

## H. PASSENGER FOOTPEG MOUNT KIT – CHROME

Designed specifically for the sport-touring rider, this chrome-plated kit allows passenger footboards to be removed and replaced with a variety of male mount-style Harley-Davidson® footpegs. The kit has 3 adjustable height positions and includes all hardware.

**50198-97B**

**\$129.95**

Fits '93-later Touring models. Does not fit Trike models.



G. ADJUSTABLE PASSENGER FOOTPEG MOUNT KIT

H. PASSENGER FOOTPEG MOUNT KIT – CHROME

*Notice: The prices appearing in this catalog are the manufacturer's suggested retail prices. Actual retail prices may vary.*

# 438 TOURING & TRIKE

## Passenger Footboards

### A. PASSENGER FOOTBOARD PANS – CHROME

Replace the factory black painted passenger footboard with the custom look of smooth chrome. The kit includes left- and right-hand traditional D-shaped footboard pans, chrome-plated, and ready to install with your Original Equipment hardware. Footboard inserts and footboard supports sold separately.

**50752-04** **\$169.95**

Fits '86-later Touring and Trike, '00-later Softail® and '06-later Dyna® models equipped with passenger footboard supports.

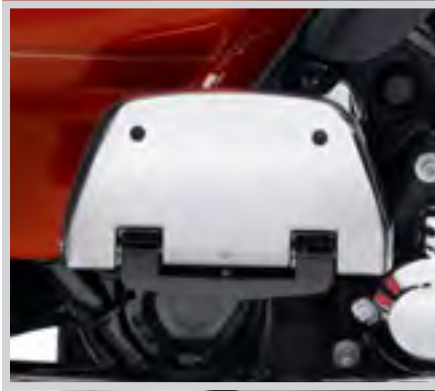

A. PASSENGER FOOTBOARD PANS – CHROME

### B. SWEEP WING PASSENGER FOOTBOARD PANS

These unique Swept Wing Passenger Footboard pans complement the Swept Wing Rider Footboard shape, and allow you to replace the Original Equipment passenger footpegs on certain models with footboards. When folded, the footboard displays a mirror-chrome surface in your choice of smooth or "ball-milled" grooved design. Footboard inserts and footboard supports sold separately.

Fits '86-later Touring, '00-later Softail and '06-later Dyna models equipped with passenger footboard supports. Does not fit Trike models.

**50716-04** Chrome – Smooth. **\$159.95**

**50357-04** Chrome – Grooved. **\$169.95**

**50500041** Black – FLHX Script. **\$169.95**



B. SWEEP WING PASSENGER FOOTBOARD PANS – CHROME SMOOTH

### C. HALF-MOON PASSENGER FOOTBOARD PANS AND INSERTS

Styled to match the Half-Moon Rider Footboards, these classic passenger footboards add both style and comfort to your nostalgic ride. Available in mirror-finish chrome or gloss black finish, the kit includes left and right footboard pan and vibration-isolation footboard inserts. Model-specific footboard mounts are sold separately.

Fits '86-later Touring, '00-later Softail and '06-later Dyna models equipped with passenger footboard supports. Does not fit Trike models.

**50807-08** Chrome. **\$189.95**

**50810-08** Gloss Black. **\$179.95**



B. SWEEP WING PASSENGER FOOTBOARD PANS – CHROME GROOVED

B. SWEEP WING PASSENGER FOOTBOARD PANS – BLACK FLHX SCRIPT



C. HALF-MOON PASSENGER FOOTBOARD PANS – CHROME

C. HALF-MOON PASSENGER FOOTBOARD PANS – GLOSS BLACK

*Notice: The prices appearing in this catalog are the manufacturer's suggested retail prices. Actual retail prices may vary.*



# TOURING & TRIKE 439

Passenger Footboards



**D. ROAD KING CLASSIC PASSENGER FOOTBOARD COVERS**



## **D. ROAD KING® CLASSIC PASSENGER FOOTBOARD COVERS**

The latest in the family of Road King® Classic-inspired accessories, this chrome-plated steel footboard cover features a chrome die-cast Road King Classic medallion with black accents and a stylish leather accent piece. Mounting hardware included.

**50246-00** **\$79.95**

Fits '87-later Touring and Trike, '86-later FL Softail® and '06-later Dyna® models equipped with traditional D-shaped aluminum passenger footboards.

## **E. V-LOGO PASSENGER FOOTBOARD COVERS**

V-Logos are die-cast aluminum integrated with the cover, then chrome-plated for a desirable shine. Includes all mounting hardware.

**50194-96** **\$65.95**

Fits '87-later Touring and Trike, '86-later FL Softail and '06-later Dyna models equipped with traditional D-shaped aluminum passenger footboards.



**E. V-LOGO PASSENGER FOOTBOARD COVERS**



**F. CONCHO PASSENGER FOOTBOARD COVERS**

## **F. CONCHO PASSENGER FOOTBOARD COVERS**

Heritage Softail® Classic-inspired conchos make these covers look great whether footboards are up or down.

**50193-96** **\$79.95**

Fits '87-later Touring and Trike, '86-later FL Softail and '06-later Dyna models equipped with traditional D-shaped aluminum passenger footboards.

## **G. WILLIE G SKULL PASSENGER FOOTBOARD COVERS**

Chrome-plated steel footboard cover disguises the Original Equipment passenger footboard, and features a three-dimensional sculptured medallion with the Harley-Davidson skull logo. This easy-to-install kit includes all required mounting hardware.

**50836-07** **\$79.95**

Fits '87-later Touring and Trike, '86-later FL Softail and '06-later Dyna models equipped with traditional D-shaped aluminum passenger footboards.



**G. WILLIE G SKULL PASSENGER FOOTBOARD COVERS**



**H. HARLEY-DAVIDSON SCRIPT PASSENGER FOOTBOARD COVERS**

## **H. HARLEY-DAVIDSON SCRIPT PASSENGER FOOTBOARD COVERS**

Easy installation using chrome hardware.

**50782-91** **\$65.95**

Fits '87-later Touring and Trike, '86-later FL Softail and '06-later Dyna models equipped with traditional D-shaped aluminum passenger footboards.

## **I. ELECTRA GLO™ LIGHTED PASSENGER FOOTBOARD COVER KIT**

This innovative LED light kit covers the bottom side of the passenger footboard. When the passenger footboard is folded in the up position, the light will shine to the side and act as an auxiliary side marker light. When the board is folded down, the light illuminates the ground with a pool of soft light. Kit includes a pair of LED lamps with red lenses, chrome covers with Bar & Shield logo, chrome hardware, and all necessary installation components.

NOTE: Some local regulations prohibit using colored lights during vehicle operation on public streets. May not conform to local lighting regulations.

**50541-03A** **\$179.95**

Fits '84-later Softail, Touring and Trike models equipped with traditional D-shaped passenger footboards. '14-later Touring and Trike models require separate purchase of Wiring Harness P/N 69200722.



**I. ELECTRA GLO LIGHTED PASSENGER FOOTBOARD COVER KIT**

Notice: The prices appearing in this catalog are the manufacturer's suggested retail prices. Actual retail prices may vary.

# 440 TOURING & TRIKE

## Engine Guards

### A. MUSTACHE ENGINE GUARD\*

Combine classic shape and modern function for a unique twist on engine protection. The flow of this engine guard complements the bike's traditional style while the gracefully curved upper section incorporates highway pegs into the shape. The integrated rubber pads offer a comfortable and slip-resistant cushion for your feet while traveling the open road. One-piece engine guard kit includes all required mounting hardware.

Fits '09-later Touring models (except Road Glide®). Does not fit models equipped with fairing lowers.

**49155-09A** Chrome. **\$269.95**

**49442-10** Gloss Black. **\$269.95**

Fits '97-'08 Touring models (except Road Glide). Does not fit models equipped with fairing lowers.

**49155-05B** Chrome. **\$269.95**

### B. ENGINE GUARD – GLOSS BLACK\*

Protect your bike without sacrificing ground clearance or style. The one-piece engine guard is designed to complement the lines of the motorcycle, and the black finish adds the perfect finishing touch. Before the tough black powder coat finish is applied, these engine guards get an extra layer of protection from an E-Coat dip. So go on and install Engine Guard Mount Footpegs because this finish will go the distance.

**49050-09A** **\$214.95**

Fits '09-later Touring and Trike models. FLHXXX and FLRT models require the separate purchase of Steering Damper Bracket P/N 83865-09.

**46549-03** Fits '97-'08 Touring models. **\$214.95**



A. MUSTACHE ENGINE GUARD – CHROME



A. MUSTACHE ENGINE GUARD – GLOSS BLACK



B. ENGINE GUARD – GLOSS BLACK



**\*WARNING:** Engine guards may provide limited leg and cosmetic vehicle protection under unique circumstances (fall over while stopped, very low speed slide). They are not made nor intended to provide protection from bodily injury in a collision with another vehicle or any other object.



**\*WARNING:** Do not use engine guard footpegs under normal stop and go operating conditions. Doing so could result in death or serious injury.



**\*WARNING:** Do not use highway pegs under normal stop and go operating conditions. Doing so could result in death or serious injury.

Notice: The prices appearing in this catalog are the manufacturer's suggested retail prices. Actual retail prices may vary.



# TOURING & TRIKE 441

## Engine Guards



C. ENGINE GUARD – CHROME

### C. ENGINE GUARD – CHROME\*

Protect your bike without sacrificing ground clearance or style. The one-piece engine guard is designed to complement the lines of the motorcycle, and the bright chrome finish adds the perfect finishing touch.

**49050-09A** **\$214.95**

Fits '09-later Touring and Trike models. FLHXXX and FLRT models require the separate purchase of Steering Damper Bracket P/N 83865-09.

### D. CENTER STAND

Lifting your bike upright and off the side stand is ideal for cleaning and servicing, and reduces the space required for parking – handy where space is at a premium in a crowded garage, a small parking spot, or at a ride-in bike show. The robust chrome Center Stand attaches directly to the frame and does not reduce the lean angle. Designed to work with all Original Equipment suspension configurations and with Profile® suspension lowering kits, the adjustable feet can be set to lift the rear tire clear of the pavement, or to keep the rear tire on the ground for reduced lifting effort. The lifting lever is inconspicuously tucked away, and fits with all Harley-Davidson® Original Equipment and accessory footboards. Kit includes chrome stand, black mounting brackets, and all necessary installation hardware.

**91573-09A** **\$334.95**

Fits '09-later Touring models (except FLHTCUSE2/3/4/5/6, FLHTKSE, FLTRUSE and models equipped with Adjustable Passenger Footboard Mount Kit P/N 50768-07) with Original Equipment or Profile Low Suspension.

**91573-06** **\$339.95**

Fits '99-'08 Touring models with Original Equipment or Profile Low Suspension.

### E. DISPLAY STAND

This chrome Display Stand is perfect for ride-in shows. This brilliant polished chrome stand also makes it easier to check transmission fluid levels.

**99002-97A** **\$269.95**

Fits '97-'08 Touring models. Does not fit FLHRSE3/4, FLHTCUSE2/3 or '07-'08 Police models. Does not fit with oil coolers.



D. CENTER STAND



D. CENTER STAND



E. DISPLAY STAND



**\*WARNING:** Engine guards may provide limited leg and cosmetic vehicle protection under unique circumstances (fall over while stopped, very low speed slide). They are not made nor intended to provide protection from bodily injury in a collision with another vehicle or any other object.

Notice: The prices appearing in this catalog are the manufacturer's suggested retail prices. Actual retail prices may vary.

# 442 TOURING & TRIKE

## Chassis Trim – Front End

### A. LOWER FORK SLIDERS – CHROME

Competitively-priced, these chrome-plated Lower Fork Sliders give your bike upfront style. To ensure proper fitment and function, these sliders are manufactured from Original Equipment components. A perfect addition during the installation of Premium Ride or Profile® Low Front suspension components, the kit features polished, triple chrome-plating and stamped "Harley-Davidson" logo.

**45500171** **\$449.95**

Fits '14-later Touring models.

**45500200** **\$449.95**

Fits '14-later Trike models.

**45500167** **\$449.95**

Fits '00-'13 Touring models.

**45315-98** **\$449.95**

Fits '84-'99 Touring models.

**83819-09** **\$449.95**

Fits '09-'13 Trike models.

### B. LOWER FORK SLIDERS – GLOSS BLACK

These gloss black coated sliders are the ultimate extension of your bike's "dark side" and make a perfect custom addition to your blacked-out ride. Manufactured to Original Equipment specifications, the durable black coating is a great match to other H-D® black components. A perfect addition during the installation of Premium Ride or Profile Low front suspension components, this kit includes right and left sliders.

**45500172** **\$449.95**

Fits '14-later Touring models.

**46546-03** **\$429.95**

Fits '00-'13 Touring models.



A. LOWER FORK SLIDERS – CHROME



B. LOWER FORK SLIDERS – GLOSS BLACK

Notice: The prices appearing in this catalog are the manufacturer's suggested retail prices. Actual retail prices may vary.



# TOURING & TRIKE 443

Chassis Trim – Front End



**C. FRONT END KIT – CHROME**  
(‘14-LATER MODELS)



**C. FRONT END KIT – CHROME**  
(‘08-'13 MODELS)



**D. FRONT END KIT – GLOSS BLACK**  
(‘14-LATER MODELS)



**D. FRONT END KIT – GLOSS BLACK**  
(‘08-'13 MODELS)

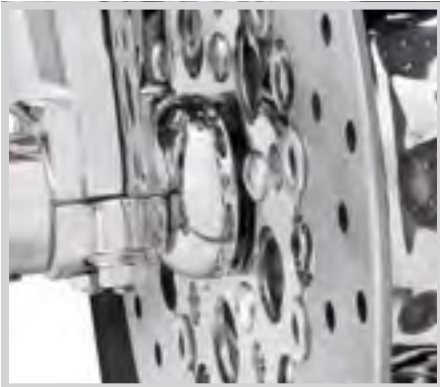

**E. FRONT WHEEL SPACERS – CHROME, DOMED**



**E. FRONT WHEEL SPACERS – CHROME, DOMED**



**E. FRONT WHEEL SPACERS –**  
**CHROME, TAPERED**



**E. FRONT WHEEL SPACERS –**  
**CHROME, STRAIGHT**

## C. FRONT END KIT – CHROME

The front forks on a Harley-Davidson® motorcycle set the tone for the bike, and can lead the way to a full-bore custom statement. So start customizing by adding chrome where it will have the most noticeable impact on the overall look of the bike: your front end. A perfect addition during the installation of Premium Ride or Profile® Low Front suspension components. This package includes components necessary to completely chrome the front forks and includes Chrome Fork Sliders, Chrome Upper Fork Slider Covers, and Classic Chrome Front Axle Nut Covers (kit components vary depending on model).

**45800037** **\$569.95**

Fits '14-later Touring models.

**45800035** **\$569.95**

Fits '08-'13 Touring models (except models with ABS option).

**45800034** **\$569.95**

Fits '08-'13 Touring models with ABS option.

**45800036** **\$569.95**

Fits '00-'07 Touring models.

## D. FRONT END KIT – GLOSS BLACK

Lead the way to the dark side. This complete blacked-out Front End Kit includes all the major components required to convert the Original Equipment satin-finished front end to a dark custom style. A perfect addition during the installation of Premium Ride or Profile Low Front suspension components. This package includes Gloss Black Fork Sliders, Gloss Black Upper Fork Slider Covers, Gloss Black Front Axle Nut Cover Kit, and Gloss Black Outer Fairing Skirt.

**45800038A** **\$599.95**

Fits '14-later Electra Glide® and Street Glide® models.

**45800022** **\$589.95**

Fits '08-'13 Electra Glide and Street Glide models.

## E. FRONT WHEEL SPACERS – CHROME

Complete your total front end with these highly polished chrome-plated wheel spacers. Manufactured to the Original Equipment tolerances, they deliver exact fitment and custom shine.

**41371-08** **\$49.95**

Domed.  
Fits '08-later Touring models with ABS brakes.

**41458-08** **\$49.95**

Tapered.  
Fits '08-later Touring models (except models with ABS brakes). Does not fit with Fork Slider End Cover P/N 46282-07.

**41610-02** **\$49.95**

Straight.  
Fits '00-'07 Touring models.

# 444 TOURING & TRIKE

## Chassis Trim – Front End

### A. UPPER FORK SLIDER COVERS – CHROME

Brilliant chrome accents for the upper fork legs. Perfect for finishing off that chromed front end look. When used with H-D® Genuine Motor Accessory Chrome Lower Fork Sliders, you've got a front end that's completely chromed and an appearance that's utterly impressive.

**45600022** **\$94.95**  
Fits '14-later Touring and Trike models.

**45963-97** **\$79.95**  
Fits '49-'84 FL, '80-'13 Touring and Trike, '86-later FLS, FLST, FLSTC, FLSTF (except '07), FLSTFB and FLSTN models.  
Stock on FLSTNSE and FLSTSE.



A. UPPER FORK SLIDER COVERS – CHROME

### B. UPPER FORK SLIDER COVERS – GLOSS BLACK

The classic Harley-Davidson® motorcycle color is black. It shows your attitude, your feelings and your desire to be different from the rest. These gloss black accessories are the ultimate extension of the Harley-Davidson philosophy. Manufactured from Original Equipment components, these parts provide superior fit and finish.

**45600023** **\$94.95**  
Fits '14-later Touring and Trike models.

**45591-02** **\$79.95**  
Fits '49-'84 FL, '80-'13 Touring, '86-later FLS, FLST, FLSTC, FLSTF (except '07), FLSTFB, FLSTSE/2/3, FLSTNSE and FLSTN models.



B. UPPER FORK SLIDER COVERS – GLOSS BLACK

### C. UPPER FORK SLIDER COVERS – CAST CHROME

Add a true custom look to the front forks on your Touring ride. These one-piece cast and chrome plated upper fork covers complement both traditional and contemporary customizing styles and look great with satin finish, chrome or gloss black fork sliders.

**45600032** **\$189.95**  
Fits '14-later Touring and Trike models.

### D. EDGE CUT UPPER FORK SLIDER COVERS

Add an edgy look to your front forks. These billet aluminum one-piece covers are finished in rich black and machined to expose the raw aluminum. The resulting contrasting surfaces complement both traditional and contemporary customizing styles, and look great with the Original Equipment satin-finished front end or with accessory chrome or black sliders. For a complete look, pair these covers with available edge cut wheels, controls, grips, mirrors and saddlebag latches.

**45600031** **\$199.95**  
Fits '14-later Touring and Trike models.

**45600006** **\$189.95**  
Fits '80-'13 Touring and Trike models.



C. UPPER FORK SLIDER COVERS – CAST CHROME



D. EDGE CUT UPPER FORK SLIDER COVERS

*Notice: The prices appearing in this catalog are the manufacturer's suggested retail prices. Actual retail prices may vary.*



# TOURING & TRIKE 445

Chassis Trim – Front End



**E. BAR & SHIELD LOGO UPPER FORK SLIDER COVERS**



**E. BAR & SHIELD LOGO UPPER FORK SLIDER COVERS**

Add a personal "Harley-Davidson" touch to your chrome front end conversion with these Upper Fork Slider Covers. The chrome-plated covers feature a recessed, engraved Bar & Shield emblem and a beaded contour at the base of the cover. Kit replaces Original Equipment satin fork slider covers for a complete finished look.

**46116-03** **\$94.95**  
Fits '49-'84 FL and '80-'13 Touring and Trike models.

**F. FLAMED UPPER FORK SLIDER COVERS**

Raised three-dimensional flames leap from the surface of the mirror-finished Upper Fork Slider Covers. The ideal finishing touch to a chrome front fork conversion, these covers replace the Original Equipment uppers for a custom look. Kit includes left and right covers.

**46165-03** **\$94.95**  
Fits '49-'84 FL and '80-'13 Touring and Trike models.



**F. FLAMED UPPER FORK SLIDER COVERS**



**G. FORK COVER MEDALLIONS – THE BURST COLLECTION**

These 5" medallions feature a curved mounting surface that fit perfectly to Upper Fork Slider Covers. Includes a slider cover mounting template. Easy to install. Sold in pairs.

**14100434** **\$59.95**  
Fits '49-'84 FL, '80-later Touring and Trike, '86-later FLST, FLSTC, FLSTF (except '07), FLSTFB, FLSTSE/2 and FLSTN models.

**H. FORK AXLE RETAINER NUT KIT – CHROME**

It's the details that count. Complete the chrome transformation by adding this finishing touch to your chrome fork sliders. This Axle Retainer Nut Kit includes the stylish chrome-plated nuts and chrome lockwashers necessary to replace the stock hardware.

**45813-03** **\$8.95**  
Fits '84-later Touring and Trike, '86-'07 FLST, FLSTC, FLSTF, FLSTN, '91-'07 FXST and FXSTB and '91-'05 FXDWG models.

**Also available:**

**FORK SLIDER DRAIN SCREW KIT – CHROME**

It's the details that count. Complete the chrome transformation by adding this finishing touch to your chrome fork sliders. This Fork Slider Drain Screw Kit includes two chrome-plated drain screws and the seals required to replace the stock hardware.

**45848-03** **\$3.95**  
Fits '87-later Softail® (except Springer™, FXCW, FXCWC, FXSB, FXSBSE and FXSTD), '87-'13 Touring and '93-'05 FXDWG models.



**G. FORK COVER MEDALLIONS – THE BURST COLLECTION**



**H. FORK AXLE RETAINER NUT KIT – CHROME**



*Notice: The prices appearing in this catalog are the manufacturer's suggested retail prices. Actual retail prices may vary.*

# 446 TOURING & TRIKE

Chassis Trim – Front End

## FRONT AXLE NUT COVERS

Cover the front axle in style. Available in your choice of styles, these custom axle nut covers look great with Original Equipment satin-finish fork sliders or as the finishing touch to a complete chrome or blacked-out front end. Easy to install kits include all necessary mounting hardware. Sold in pairs.

### A. FRONT AXLE NUT COVERS

Fits '02-'11 VRSC™ (except VRSCF, VRSCR and '12-later VRSCDX), '15-later XG, '08-later XL, '08-later Dyna®, '07-later Softail® (except Springer™, FXCW, FXCWC, FLSTNSE, FXSBSE, FXST-Aus and FXSTD) and '08-later Touring and Trike models.

<b>44117-07A</b>	Chrome – Die-cast.	<b>\$27.95</b>
<b>43000026</b>	Gloss Black – Die-cast.	<b>\$27.95</b>
<b>44116-07A</b>	Chrome – Billet.	<b>\$42.95</b>
<b>43428-09</b>	Gloss Black – Billet.	<b>\$42.95</b>

Fits '00-'07 Touring models and '04-'07 Dyna models (except '04-'05 FXDWG and '07 FXDSE).

<b>43062-04</b>	Chrome – Die-cast.	<b>\$27.95</b>
<b>43061-04</b>	Chrome – Billet.	<b>\$42.95</b>

Fits '88-'07 XL, '91-'03 Dyna FXD, FXDX, FXDXT, FXDL, FXDS-CONV.; '93-'05 FXDWG, '84-'06 Softail (except Springer and FXSTD), '80-'99 Touring models. Also fits '88-'07 FXR and '87-later FLXR/FXRS-SP and FXWG models.

<b>43899-86A</b>	Chrome – Die-cast.	<b>\$27.95</b>
------------------	--------------------	----------------

### B. WILLIE G SKULL FRONT AXLE NUT COVERS

<b>43163-08A</b>		<b>\$34.95</b>
------------------	--	----------------

Fits '02-'11 VRSC (except VRSCF, VRSCR and '12-later VRSCDX), '15-later XG, '88-later XL, '91-later Dyna, '84-later Softail (except Springer, FXCW, FXCWC, FXSB, FXSBSE, FXSTD and FLSTNSE) and '99-later Touring and Trike models.

### C. ALUMINATOR® FRONT AXLE NUT COVERS

<b>44114-07</b>		<b>\$42.95</b>
-----------------	--	----------------

Fits '02-'11 VRSC (except VRSCF, VRSCR and '12-later VRSCDX), '08-later Dyna, '07-later Softail (except Springer, FXCW, FXCWC, FXSB, FXSBSE, FXST-Aus, FXSTD and FLSTNSE) and '08-later Touring models.

<b>43059-04</b>		<b>\$42.95</b>
-----------------	--	----------------

Fits '00-'07 Touring models and '04-'07 Dyna models (except '04-'05 FXDWG and '07 FXDSE).

<b>43907-94</b>		<b>\$42.95</b>
-----------------	--	----------------

Fits '88-'07 XL, '91-'03 Dyna FXD, FXDX, FXDXT, FXDL, FXDS-CONV.; '93-'05 FXDWG, '84-'06 Softail (except Springer and FXSTD), '80-'99 Touring models. Also fits '88-'07 FXR and '87-later FLXR/FXRS-SP, FXWG models.

### D. "H-D MOTOR CO." LOGO FRONT AXLE NUT COVERS

<b>44148-07A</b>		<b>\$29.95</b>
------------------	--	----------------

Fits '02-'11 VRSC (except VRSCF, VRSCR and '12-later VRSCDX), '15-later XG, '08-later XL, '08-later Dyna, '07-later Softail (except Springer, FXCW, FXCWC, FXSB, FXSBSE, FXST-Aus, FXSTD and FLSTNSE) and '08-later Touring and Trike models.

<b>43063-04</b>		<b>\$27.95</b>
-----------------	--	----------------

Fits '00-'07 Touring models and '04-'07 Dyna models (except '04-'05 FXDWG and '07 FXDSE).

<b>43864-96</b>		<b>\$29.95</b>
-----------------	--	----------------

Fits '88-'07 XL, '91-'03 Dyna FXD, FXDX, FXDXT, FXDL, FXDS-CONV.; '93-'05 FXDWG, '84-'06 Softail (except Springer and FXSTD), '80-'99 Touring models. Also fits '88-'07 FXR and '87-later FLXR/FXRS-SP, FXWG models.

### E. TAPERED FRONT AXLE NUT COVERS

<b>44109-07</b>		<b>\$27.95</b>
-----------------	--	----------------

Fits '02-'11 VRSC, (except VRSCF, VRSCR and '12-later VRSCDX), '08-later Dyna, '07-later Softail (except Springer, FXCW, FXCWC, FXSB, FXSBSE, FXST-Aus, FXSTD and FLSTNSE) and '08-later Touring models.

<b>43051-01</b>		<b>\$27.95</b>
-----------------	--	----------------

Fits '00-'07 Touring and '04-'07 Dyna models (except '04-'05 FXDWG and '07 FXDSE).



A. FRONT AXLE NUT COVERS – CHROME



A. FRONT AXLE NUT COVERS – GLOSS BLACK



B. WILLIE G SKULL FRONT AXLE NUT COVERS



C. ALUMINATOR FRONT AXLE NUT COVERS



D. "H-D MOTOR CO." LOGO FRONT AXLE NUT COVERS



E. TAPERED FRONT AXLE NUT COVERS

Notice: The prices appearing in this catalog are the manufacturer's suggested retail prices. Actual retail prices may vary.





**F. BURST FRONT AXLE NUT COVERS**



**G. FORK SLIDER END COVERS**



**H. AIR WING CALIPER COVER**



**I. FRONT CALIPER COVER**



**J. AIR WING CALIPER AND ROTOR COVER**



**K. CALIPER ROTOR COVER – CHROME**

# TOURING & TRIKE 447

Chassis Trim – Front End

## F. BURST FRONT AXLE NUT COVERS

Finish your blacked-out forks in style. Rich black and prismatic machined surfaces provide the contrast, and the race-track ridges and the inner spider design make a powerful visual statement. This easy to install kit includes mounting hardware.

**43000031 \$69.95**

Fits '02-'11 VRSC™ (except VRSCF, VRSCR and '12-later VRSCDX), '15-later XG, '08-later XL, '08-later Dyna®, '07-later Softail® (except Springer™, FXCW, FXCWC, FXSB, FXSBSE, FXSTD and FLSTNSE) and '08-later Touring and Trike models.

## G. FORK SLIDER END COVERS

Lead the way with chrome. This Fork Slider End Cover Kit is contoured to complement the shape of the front fork slider. Designed to conceal the front axle and fork slider hardware, the smooth chrome surface complements both Original Equipment satin finish and accessory chrome lower fork sliders. Complete kit includes all necessary installation hardware.

**46282-07 \$84.95**

Fits '00-'13 Touring (except models equipped with ABS brakes). Installation requires removal of Original Equipment or accessory axle nut covers. Does not fit with Tapered Wheel Spacers P/N 4145-08. Does not fit Trike models.

## H. AIR WING CALIPER COVER

Surround your calipers in chrome. These mirror-chrome deep-drawn steel covers hide the Original Equipment painted calipers, and feature a sweeping Air Wing design and subtle Bar & Shield logo to enhance the look. Installation does not require brake line removal. Kit includes left- and right-hand covers and all necessary mounting hardware.

**44729-09 \$94.95**

Fits '08-'13 Touring models. Does not fit Trike models.

## I. FRONT CALIPER COVER

Chrome-plated caliper covers styled with stepped contours and textured recess for a distinctive look. Split cover design does not require brake line removal. Sold in pairs.

**43798-00 \$79.95**

Fits '00-'07 Touring models. Does not fit with braided brake lines.

## J. AIR WING CALIPER AND ROTOR COVER

Add a custom look to the front of your bike. These easy-to-clean mirror-chrome rotor covers surround the brake disc for a stylish appearance, and the matching deep-drawn steel covers hide the Original Equipment painted calipers. The Caliper Covers feature a sweeping Air Wing design and subtle Bar & Shield logo to enhance the look. Installation does not require brake line removal. Kit includes left- and right-hand covers and all necessary mounting hardware.

**44013-09A \$199.95**

Fits '08-'13 Touring models (except '09 FLTRSE3). Does not fit Trike models.

## K. CALIPER ROTOR COVER – CHROME

Add clean, chrome style to your front end with this cover, which features high-quality chrome-plating that complements the lines of your bike.

**42230-00 \$214.95**

Fits '00-'07 Touring models. Requires separate purchase of (1) Medallion Kit P/N 42231-00, 42235-00 or 42232-00.

TOURING

*Notice: The prices appearing in this catalog are the manufacturer's suggested retail prices. Actual retail prices may vary.*

# 448 TOURING & TRIKE

## Chassis Trim – Brakes

### A. BRAKE CALIPER KIT – RED

Dress your bike in the latest high-performance look. Brilliant red calipers make a powerful visual statement, and set your bike apart from the ordinary. Manufactured from Original Equipment components for proven performance, these calipers will add a stylish touch to the stock bike, or add the perfect finish to a complete custom equipped with chrome or blacked-out wheels, rotors, and fork sliders.

**41300116** Front – Dual Disc. **\$499.95**  
Fits '06-later VRSC™, '08-later Touring and '09-'13 Trike models. Brake pads sold separately.

**41300120** Front – Dual Disc. **\$399.95**  
Fits '02-'05 VRSC, '00-'03 XL, '00-'07 Dyna® and '00-'07 Touring models with dual disc front brakes. Brake pads sold separately.



A. FRONT BRAKE CALIPER KIT – RED  
(41300116 SHOWN)

### B. BRAKE CALIPER KIT – CHROME

Add the shine of chrome to your bike with these highly polished Chrome Brake Caliper Kits. Manufactured from Original Equipment components for proven performance, these calipers are a great addition to the stock bike, or add the finishing touch to a complete custom equipped with chrome wheels, rotors, and fork sliders. (Brake pads and pad pins not included.)

**42012-06A** Front – Dual Disc. **\$899.95**  
Fits '06-later VRSC, '08-later Touring and '09-'13 Trike models.

**44392-00A** Front – Dual Disc. **\$799.95**  
Fits '00-'03 XL, '02-'05 VRSC, '00-'07 Dyna, Softail® and Touring models equipped with dual disc front brakes.



A. FRONT BRAKE CALIPER KIT – RED  
(41300120 SHOWN)



B. FRONT BRAKE CALIPER KIT – CHROME  
(42012-06A SHOWN)



B. FRONT BRAKE CALIPER KIT – CHROME  
(44392-00A SHOWN)

Notice: The prices appearing in this catalog are the manufacturer's suggested retail prices. Actual retail prices may vary.



# TOURING & TRIKE 449

Chassis Trim – Brakes



**C. CALIPER SCREEN INSERT – CHROME**



## C. CALIPER SCREEN INSERT – CHROME

These chrome-plated Caliper Inserts replace the Original Equipment satin-finish screens featured on Brembo® brake calipers. Easy pop-in installation. Sold individually.

Fits '06-later VRSC™ and '08-later Touring models

<b>42054-05</b>	Front.	<b>\$29.95</b>
<b>42053-05</b>	Rear.	<b>\$29.95</b>

## D. BRAKE CALIPER INSERTS

Easy-to-install inserts add a finishing touch to the front and rear brake calipers. Select a style that follows your custom direction. Self-adhesive backing.

Fits '00-later front and rear brake calipers on all models (except Springer™ front, '08-later Touring and Trike, '04-later XL, '15-later XG and '06-later VRSC models).

<b>1. 44477-99</b>	Classic Chrome.	<b>\$16.95</b>
<b>2. 44476-99</b>	"Harley-Davidson" Script.	<b>\$16.95</b>
<b>3. 44474-99</b>	Flames.	<b>\$16.95</b>
<b>4. 44542-03</b>	Deep Dish.	<b>\$16.95</b>



**D. BRAKE CALIPER INSERTS**



**E. BRAKE CALIPER TRIM DISCS**

## E. BRAKE CALIPER TRIM DISCS

Available in 1.375" and 1.75" diameters to accommodate front and rear calipers on most '99-earlier models, and front calipers on '00-later Springer models. Easy to install.

<b>1. 44095-96</b>	"H-D Motor Co." – 1.375" Diameter.	<b>\$16.95</b>
<b>1. 44093-96</b>	"H-D Motor Co." – 1.75" Diameter.	<b>\$16.95</b>
<b>2. 99661-92T</b>	Gold Live to Ride – 1.375" Diameter.	<b>\$16.95</b>
<b>2. 99663-92T</b>	Gold Live to Ride – 1.75" Diameter.	<b>\$16.95</b>
<b>3. 99679-98</b>	Flames – 1.375" Diameter.	<b>\$11.95</b>

## F. BANJO BOLT KIT – CHROME

Replace the Original Equipment zinc finish brake line hardware with brilliant chrome custom banjo bolts.

**41843-08** **\$49.95**

Fits '06-later VRSC, '08-later Touring and '09-'13 Trike models.

## BANJO BOLT KIT – CHROME

Replace the Original Equipment 12-point zinc finish brake line hardware with brilliant chrome custom tapered banjo bolts.

**41844-06** **\$29.95**

Fits '02-'05 VRSCA and VRSCB models and '93-'07 Touring models. Does not fit with Banjo Bolt Cover P/N 32715-98. Kit includes three .375" banjo bolts and six sealing washers.

## G. CALIPER HARDWARE KIT – CHROME

Chrome-plated hardware is a great finishing touch to Chrome Brake Calipers. This kit replaces the Original Equipment black 12-point bolts on a single caliper.

**44473-02A** **\$44.95**

Fits '00-'07 models (except Springer front caliper, '04-later XL, '06-later FX Softail rear calipers and '06-later VRSC models).



**F. BANJO BOLT KIT – CHROME**



**F. BANJO BOLT KIT – 41843-08**



**F. BANJO BOLT KIT – 41844-06**



**G. CALIPER HARDWARE KIT – CHROME**

Notice: The prices appearing in this catalog are the manufacturer's suggested retail prices. Actual retail prices may vary.

# 450 TOURING & TRIKE

Chassis Trim – Brakes

## A. CUSTOM CALIPER BOLT COVER KIT

Cover your 12-point caliper bolts in chrome. These easy-to-install chrome covers are held firmly in place with a steel spring clip, and are styled to match the Chrome Rocker Box Bolt and Headbolt Covers.

**43824-03** Four Large Covers. **\$23.95**

Fits '00-later front and rear 12-point caliper mounting bolts (except Springer™ front calipers, '15-later XG, '08-later Touring and Trike and '06 VRSCR models).

**40955-05** Four Large and Two Small Covers. **\$28.95**

Fits '00-later front brake calipers (except Springer, '15-later XG, '04-later XL, '08-later Touring and Trike, '06-later VRSC™ and models equipped with caliper covers). Also fits rear calipers on '06-later Softail® models (except FXCW).

**40959-05** Three Large and Two Small Covers. **\$23.95**

Fits '00-later rear brake calipers (except '15-later XG, '04-later XL, '08-later Touring and Trike, '06-later FXST, FXSTB, FXSTS and FLSTSB, '06-later VRSC and models equipped with caliper covers).



A. CUSTOM CALIPER BOLT COVER KIT

## B. 1. BRAKE BLEEDER SCREW COVER

This cover adds chrome to the unfinished bleeder valve on all stock H-D® calipers. Package of two.

**43834-98** **\$23.95**

Fits '84-later stock calipers (except XR models).

## 2. BANJO BOLT COVER

Die-cast chrome cover provides a custom look to your stock banjo bolts. Fits banjo bolts on front and rear brake master cylinders and front and rear calipers. Installs in seconds.

**32715-98** **\$21.95**

Fits '84-later models with stock master cylinders and calipers. (Does not fit VRSC Rear Master Cylinder, '06-later VRSC calipers, '08-later Touring and Trike or '04-later XL models.)



B. BLEEDER SCREW AND BANJO BOLT COVERS

## C. BRAKE ROTOR HARDWARE KIT – CHROME

It's the details that make the difference, like this chrome hardware kit that really gets your bike noticed. This hardware adds a unique chrome-plated finish to the Original Equipment or accessory floating brake rotors.

**41500095** Button Head – Front **\$39.95**

Fits '09-later Touring models equipped with Enforcer or Impeller Wheels.

**91800029** Shoulder Bolts – Front. **\$29.95**

Fits '02-later models equipped with Open Brake Rotor P/N 44343-01, 44553-06A, 41500012A, 41500040 or 41500042.

**46646-05** Button Head – Front. **\$13.95**

Fits '90-later models (except VRSC and '14-later Touring and Trike models equipped with Open Brake Rotor P/N 44343-01, 44553-06A, 41500012, 41500040 or 41500042).

**46647-05** Button Head – Rear. **\$13.95**

Fits '92-later models.



C. BRAKE ROTOR HARDWARE KIT – CHROME  
(41500095 SHOWN)



C. BRAKE ROTOR HARDWARE KIT – CHROME  
(91800029 SHOWN)



C. BRAKE ROTOR HARDWARE KIT – CHROME  
(46646-05 SHOWN)

*Notice: The prices appearing in this catalog are the manufacturer's suggested retail prices. Actual retail prices may vary.*



# TOURING & TRIKE 451

Fender Trim



**D. AIR WING FRONT FENDER RAIL**

## D. AIR WING FRONT FENDER RAIL\*

Shaped by the wind, this aerodynamic front fender rail features an inverted-wing tip and support rails that complement the sweeping lines of the fender. As a stylish replacement for the traditional rubber bumper and rails, the completed installation mirrors the design of the Original Equipment fender tip and spears. The hidden hardware adds to the clean, custom appearance. The mirror-chrome surface and embossed Harley-Davidson lettering finishes the look.

**59600022** \$99.95

Fits '14-later FLHTCU, FLHTCUL, FLHTK and FLHTKL models.

**59600012** \$99.95

Fits '80-'13 FLHR, FLHRC, FLT, FLHT, FLHTC, FLHTCU, FLHTK, FLHTCUTG and '80-'93 FLHS models. Does not fit '98-later FLHX, FLTR or FLHRS models or any models with a clean front fender.



**D. AIR WING FRONT FENDER RAIL**



**E. ELECTRA GLIDE SPORT AND ROAD KING FRONT BUMPER ASSEMBLY**

## E. ELECTRA GLIDE® SPORT AND ROAD KING® FRONT BUMPER ASSEMBLY\*

Add style and protection to the front fender of your Electra Glide® Sport or Road King® motorcycle.

**91085-83D** \$139.95

Fits '87-'93 FLHS, '94-'13 FLHR and '96-'13 FLHT models.

Does not fit '98-later FLTR models or Trike models.

## F. V-LOGO FRONT FENDER RAIL\*

A stylish re-creation of a popular Hydra Glide accessory, this twin tube design sweeps smartly back along the front fender. Matching Touring Front Fender Rail P/N 91100-94 integrates the styling from front to rear. Includes mounting hardware and installation instructions.

**91099-94A** \$99.95

Fits '80-'13 FLT, FLHT, FLHTC, FLHTCU, FLHTK, FLHR, FLHRC, FLHTCUTG and '80-'93 FLHS models. Does not fit '98-later FLHX, FLTR or FLHRS models.

## G. V-LOGO REAR FENDER RAIL\*

Designed with a similar styling theme to match our Touring V-Logo Front Fender Rail P/N 91099-94A. Replaces the stock rear fender rail and rubber bumper on Touring models. Chrome-plated twin tubes are crowned with a hand-polished and chrome-plated cast V-Logo reminiscent of the Harley-Davidson® 1953 Golden Anniversary medallion. Includes hardware and installation instructions.

**91100-09** \$99.95

Fits '09-later FLHR, FLHRC, FLHT, FLHTC, FLHTCU, FLHTCUL, FLHTK, FLHTKL, FLTR and FLTRU models. Does not fit with mud flaps.

**91100-94** \$99.95

Fits '80-'08 FLT, FLHT, FLHR, FLHRC, '98-'03 FLTR and '80-'93 FLHS models. Does not fit with mud flaps.

## H. FENDER RAIL INSERTS

This accessory closes the fender rail gap and features a Bar & Shield logo with black grooves for a clean, custom look. Kit includes all necessary hardware and mounting brackets.

**91358-99A** Front. \$89.95

Fits '80-'13 Tour Glide™, FLHTC, FLHTCU and FLHTCUTG models. Does not fit '98-later FLTR, FLHRS or '94-later FLHR models.

**91357-99A** Rear. \$74.95

Fits '80-'08 Tour Glide, FLHS, FLHR, FLHT/C and FLHTCU models and '06-'08 FLHX models. Does not fit FLHRCI, FLHRS and FLTR.



**F. V-LOGO FRONT FENDER RAIL**



**G. V-LOGO REAR FENDER RAIL**



**H. FENDER RAIL INSERT – FRONT**



**H. FENDER RAIL INSERT – REAR**



**\*WARNING:** Fender rails are decorative items only. Do not strap anything to the rails. Adding any additional weight to the front fender could adversely affect vehicle handling, causing loss of control and death or serious injury.

Notice: The prices appearing in this catalog are the manufacturer's suggested retail prices. Actual retail prices may vary.

# 452 TOURING & TRIKE

## Fender Trim

### A. FRONT FENDER TRIM KIT – CHROME

Replace the Original Equipment stainless steel fender trim with a splash of chrome. Kit includes left and right side trim strip.

**59209-91T** \$29.95

Fits '82-'13 Touring models (except Road Glide® and Road King® Custom), '86-later FLSTN and FLSTC models. Does not fit models equipped with clean front fender.



A. FRONT FENDER TRIM KIT – CHROME

### B. FRONT FENDER TRIM

Add a sweeping dash of chrome to the front fender. Chrome-plated tapered spear features a stepped design that accentuates the flowing fender lines. Self-adhesive backing simplifies installation.

**14100618** \$44.95

Fits Dyna® FLD, FL Softail®, Touring and Trike models with full front fender.

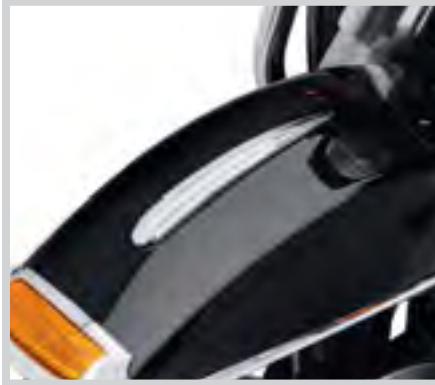

B. FRONT FENDER TRIM KIT

### C. BAR & SHIELD LOGO FRONT FENDER SPEAR

This chrome-plated trim spear adds a sweeping dash of chrome to the front fender. Featuring a raised Bar & Shield logo set against a textured black field, this self-adhesive medallion is easy to install.

**91195-04** Large. \$44.95

Fits Dyna FLD, FL Softail, Touring and Trike models (except FLSTSB).



C. BAR & SHIELD LOGO FRONT FENDER SPEAR

### D. BAR & SHIELD FENDER TIP LENS KIT

Chrome-plated polycarbonate construction features translucent Bar & Shield emblems. The kit includes front and rear lenses. Front lens features an amber Bar & Shield, rear lens features a red Bar & Shield. Quick and easy installation.

**59081-96** Front and Rear. \$29.95

Fits '80-'08 FLHT, FLT, FLHS, FLHR models and '86-'08 FLSTC, '93-'96 FLSTN models. (Does not fit Springer™, FLHRS or FLTR models.)



D. BAR & SHIELD FENDER TIP LENS

### E. FENDER TIP LENS KIT WITH SKULL LOGO

This chrome-plated Fender Tip Lens Kit adds a little attitude to your ride. The kit features front and rear lenses with a translucent illuminated skull silhouette. The easy-to-install kit includes an amber front lens and red rear lens.

**59651-01** \$29.95

Fits '80-'08 Electra Glide®, Tour Glide™, FLHS, Road King (except Road King Classic and FLHRS) and '86-'08 FLSTC and '93-'96 FLSTN models.



E. FENDER TIP LENS WITH SKULL LOGO

### F. "LIVE TO RIDE" LOGO FENDER TIP

Made of durable ABS plastic. Includes mounting hardware and installation instructions.

**59068-96** Front. \$35.95

Fits '80-'13 FLT, FLHTCUTG, FLHR, FLSTC and '93-'96 FLSTN models (replaces fender lamp assembly). (Does not fit Springer, FLHRS and FLTR models.)

**59069-96** Rear. \$35.95

Fits '80-'08 FLT, FLHR, FLSTC and '93-'96 FLSTN models (replaces fender lamp assembly). (Does not fit Springer, FLHRS or FLTR Road Glide models.)



F. "LIVE TO RIDE" LOGO FENDER TIP

### G. "H-D" CLASSIC FENDER TIP

Stock on Road King Classic models, these nostalgic-look fender tips are also available for other models. Replaces fender lamp assembly.

**59002-98** Front. \$31.95

Fits '80-'13 FL, FLHR and FLHTCUTG models and '86-'08 FLSTC models.

**59052-98** Rear. \$31.95

Fits '80-'08 FL and FLHR models and '86-'99 FLSTC models. (Does not fit FLSTF and FLTR models.)



G. "H-D" CLASSIC FENDER TIP

Notice: The prices appearing in this catalog are the manufacturer's suggested retail prices. Actual retail prices may vary.





**H. FRONT FENDER RAIL AND STANCHION KIT**

# TOURING & TRIKE 453

Fender Trim

**H. FRONT FENDER RAIL AND STANCHION KIT\***

Chrome-plated accents straight from our 1947 catalog. Includes template for easy installation.

**91117-97 \$69.95**

Fits '84-later FL Softail® (except FLS, FLSTF, FLSTNSE, FLSTFB, FLSTSE/2/3 and FLSTSB) and Touring models.

**I. WILLIE G SKULL FENDER SKIRT**

This decorative chrome-plated fender skirt is a direct replacement for stock fender skirt. Features a three-dimensional sculptured concho with skull design set off with black accents. Mounting hardware included.

**59582-02A \$59.95**

Fits '80-'13 Touring, '09-'13 Trike, '86-'08 FLSTC, '06 FLST and '93-'96 FLSTN models equipped with Original Equipment fender skirt.

**J. FLAMES FENDER SKIRT**

Designed as an easy-to-install replacement for the Original Equipment fender skirt, this chrome steel fender skirt features an embossed 3-D flame design. Kit includes mounting hardware.

**60179-06 \$59.95**

Fits '80-'13 Touring, '09-'13 Trike, '86-'08 FLSTC, '06 FLST and '93-'96 FLSTN models equipped with Original Equipment fender skirt.

**K. BAR & SHIELD FENDER SKIRT**

This rigid-steel fender skirt, designed to replace the original factory-equipped aluminum trim, is formed, polished, and chrome-plated. Its ribbed pattern offers a unique styling element and adds rigidity. Subtle but distinctive brushed aluminum Bar & Shield logos are framed by a stamped-in ribbed outline on both sides.

**59228-91 \$59.95**

Fits '80-'13 Touring, '09-'13 Trike, '86-'08 FLSTC, '06 FLST and '93-'96 FLSTN models equipped with Original Equipment fender skirt.

**L. ROAD KING® CLASSIC FENDER SKIRT**

The latest in the family of Road King-inspired accessories, this chrome-plated steel fender skirt features four raised accent ribs and a die-cast Road King® Classic medallion in chrome with black accents. Mounting hardware included.

**59005-98 \$59.95**

Fits '80-'13 Touring and '09-'13 Trike models equipped with Original Equipment fender skirt.

**M. V-LOGO FENDER SKIRT**

V-Logos are die-cast aluminum integrated with the fender skirt, then chrome-plated for a desirable shine. Includes all mounting hardware.

**59146-96 \$59.95**

Fits '80-'13 Touring, '09-'13 Trike, '86-'08 FLSTC, '06 FLST and '93-'96 FLSTN models equipped with Original Equipment fender skirt.

**N. CONCHO FENDER SKIRT**

This decorative fender skirt features conchos inspired by the Heritage Softail® Classic motorcycle.

**59147-96 \$59.95**

Fits '80-'13 Touring, '09-'13 Trike, '86-'08 FLSTC, '06 FLST and '93-'96 FLSTN models equipped with Original Equipment fender skirt.



**I. WILLIE G SKULL FENDER SKIRT**



**J. FLAMES FENDER SKIRT**



**K. BAR & SHIELD FENDER SKIRT**



**L. ROAD KING CLASSIC FENDER SKIRT**



**M. V-LOGO FENDER SKIRT**



**N. CONCHO FENDER SKIRT**



**\*WARNING:** Fender rails are decorative items only. Do not strap anything to the rails. Adding any additional weight to the front fender could adversely affect vehicle handling, causing loss of control and death or serious injury.

Notice: The prices appearing in this catalog are the manufacturer's suggested retail prices. Actual retail prices may vary.

# 454 TOURING & TRIKE

## Fender Trim

### A. FRONT FENDER ADAPTER KIT

Add a true custom style to your Touring model. This polished and chrome-plated Adapter Kit will allow you to install the smooth curving Fat Boy® or Street Stalker® front fender on your Touring bike. Manufactured from 6061-T6 billet aluminum, this kit includes all necessary mounting hardware. See your Dealer for primed or Color-Matched fender options.

**58900085** **\$99.95**  
Fits '14-later Touring models (except models equipped with fairing lowers). Does not fit Trike models.

**59013-02A** **\$84.95**  
Fits '00-'13 FLHT, FLHX, FLHTC, FLHTCU and FLHTK models. Does not fit Trike models.

### B. FL TOURING CLEAN FRONT FENDER

With no holes, this fender provides the starting point for customization. Offered in primed finish and ready to bolt onto existing brackets.

**59045-00B** **\$299.95**  
Fits '94-'13 FLHR and '89-'13 FLT and FLHT models.

### C. STREET STALKER® FRONT FENDER KIT\*

The smooth curves of the Street Stalker® Front Fender easily create a clean, custom front-end look. Made from high-impact, injection-molded composite materials. Includes mounting hardware.

Fits '86-later FL Softail® models (except Springer™). Also fits '00-later Touring models (except models equipped with fairing lowers) with separate purchase of Fender Adaptor Kit P/N 59013-02A or P/N 58900085.

**59397-98** Primed. **\$134.95**  
**59397-03DH** Vivid Black. **\$199.95**



A. FRONT FENDER ADAPTER KIT – '14-LATER MODELS



A. FRONT FENDER ADAPTER KIT – '00-'13 MODELS



B. FL TOURING CLEAN FRONT FENDER

C. STREET STALKER FRONT FENDER KIT – VIVID BLACK

\*NOTE: This product is a "Paint to Order" accessory. Please allow for an average of 5 weeks delivery for this item.

Notice: The prices appearing in this catalog are the manufacturer's suggested retail prices. Actual retail prices may vary.



# TOURING & TRIKE 455

Chassis Trim



**D. WATER PUMP COVER – CHROME**



## D. WATER PUMP COVER – CHROME

Dress the Twin-Cooled™ Touring model's Water Pump Cover in style. This Chrome Water Pump is designed to hug the contours of the water pump, and conceals many of the coolant lines and fittings for a custom look. A direct replacement for the Original Equipment black plastic cover, this kit can be installed in minutes.

**61400225** **\$74.95**  
Fits '14-later FLHTCU, FLHTCUL, FLHTK, FLHTKL and FLHTCUTG models equipped with Twin-Cooled engines.

## E. OIL COOLER COVER KIT – CHROME

Dress the Touring and Trike oil cooler in style. This chrome Oil Cooler Cover is designed to hug the contours of the cooler body while allowing complete airflow across the surface. Kit includes required mounting hardware.

**63121-11A** **\$59.95**  
Fits '11-later Touring and Trike (except models equipped with Twin-Cooled engines).

**25700007** **\$59.95**  
Fits '09-'10 Touring and Trike models.

**62995-04** **\$59.95**  
Fits '99-'06 Touring models equipped with Touring Oil Cooler Kit P/N 62895-03A.

## F. VOLTAGE REGULATOR COVER – CHROME

This chrome-plated steel cover features an open-faced design to allow airflow through the voltage regulator. Chrome-plated mounting hardware included.

**74538-09** **\$44.95**  
Fits '09-'13 Touring (except models with oil coolers). Will not fit models equipped with a sidecar.

**74543-00** **\$44.95**  
Fits '97-'08 Electra Glide®, Road Glide® and Road King® (except models with oil coolers). Will not fit '07-later models equipped with a sidecar.

## G. VOLTAGE REGULATOR – CHROME

Original Equipment voltage regulators with a sparkling triple-plated chrome finish. Hand-buffed, then copper-, nickel- and chrome-plated, these brilliant chrome-plated regulators are the perfect highlight for any Harley-Davidson® motorcycle.

**74622-09** **\$179.95**  
Fits '09-later Touring and Trike models (except '14-later FLHTKSE, FLHRSE and '15-later FLTRUSE and FLHXSE).

**74622-06** Fits '06-'08 Touring models. **\$179.95**

**74622-04** Fits '04-'05 Touring models. **\$179.95**

**74537-93A** **\$149.95**  
Fits '89-'95 1340 models, '96 FLT, FLHT and FLHR models (except fuel injected), '96-'99 Softail® and '96-'98 Dyna® models.

## H. FUEL TANK MOUNTING HARDWARE KIT – CHROME

Beauty lies in the details, and this chrome-plated Fuel Tank Mounting Hardware Kit ensures you won't leave this one overlooked. The perfect finishing touch to your fuel tank, the kit includes the "Bullet Tip" custom bolts and machined washers required for the specific model application. Hardware design matches the Chrome Bullet Tip Footpeg Bolt Kit P/N 94133-01 and other available accessories.

**62920-00A** **\$39.95**  
Fits '98-later Touring and Trike models.



**E. OIL COOLER COVER KIT – CHROME ('11-LATER MODELS SHOWN)**



**E. OIL COOLER COVER KIT – CHROME ('99-'06 MODELS SHOWN)**



**F. VOLTAGE REGULATOR COVER – CHROME ('09-'13 MODELS SHOWN)**



**F. VOLTAGE REGULATOR COVER – CHROME ('97-'08 MODELS SHOWN)**



**G. VOLTAGE REGULATOR – CHROME**



**H. FUEL TANK MOUNTING HARDWARE KIT – CHROME**

TOURING

Notice: The prices appearing in this catalog are the manufacturer's suggested retail prices. Actual retail prices may vary.

# 456 TOURING & TRIKE

## Headlamp Trim

### A. GLOSS BLACK NACELLE AND HANDLEBAR COVER KIT

The classic Harley-Davidson® motorcycle color is black. It shows your attitude, your feelings and your desire to be different from the rest. These gloss black accessories are the ultimate extension of the Harley-Davidson philosophy. Manufactured from Original Equipment components, these parts provide superior fit and finish. Complete the look with a Gloss Black Headlamp Trim Ring P/N 46555-03B (sold separately).

**46547-03A** \$299.95  
Fits '94-'13 FLHR and FLHRC models.

### B. HEADLAMP TRIM RINGS – GLOSS BLACK

Finish the Dark Custom™ look by replacing the Original Equipment chrome headlamp trim ring with sinister black. Easy to install, the ring's rich black surface matches the stock headlamp shell finish for a unified look.

**46555-03B** 7" Headlamp. \$34.95  
Fits '94-'14 Touring models (except Road Glide®).

**67700117** 4" Passing Lamp. \$46.95  
Fits '62-later models equipped with Original Equipment or accessory Auxiliary Lamp Kits. Sold in pairs.

### C. HEADLAMP TRIM RING – BURST COLLECTION

Sculpted machining sends reflections of light in all directions. This Headlamp Trim Ring features a rich black anodized finish that is machined to expose the highlights of raw aluminum. The contrasting cut-back look makes a powerful visual statement, and works great with both traditional and contemporary customizing styles. Easy to install.

**61400149** \$139.95  
Fits '96-'13 Electra Glide®, Street Glide® and Trike models. (except FLHTCUSE6/7/8 or FLHXSE2). Does not fit with Fairing Bra P/N 57800-00. Does not fit with accessory headlamps 67700040A, 73390-10A or 90050-02A.

#### Shown with:

### AUXILIARY LAMP TRIM RINGS – BURST COLLECTION

Lamp Trim Rings feature a rich black anodized finish that is machined to expose the highlights of raw aluminum. Easy to install.

**61400255** Auxiliary Lamps. \$199.95  
Fits '62-later models equipped with Original Equipment or accessory Auxiliary Lamp Kits. Sold in pairs.



A. GLOSS BLACK NACELLE AND HANDLEBAR COVER KIT  
(SHOWN WITH GLOSS BLACK HEADLAMP TRIM RING)



B. HEADLAMP TRIM RINGS – GLOSS BLACK



C. HEADLAMP TRIM RING – BURST COLLECTION

Notice: The prices appearing in this catalog are the manufacturer's suggested retail prices. Actual retail prices may vary.



# TOURING & TRIKE 457

Fairing Trim



**D. TIE-DOWN BRACKETS – CHROME**



**D. TIE-DOWN BRACKETS – '14-LATER MODELS**



**D. TIE-DOWN BRACKETS – '95-LATER MODELS**



**E. OUTER FAIRING SKIRT – GLOSS BLACK**



**E. OUTER FAIRING SKIRT – '14-LATER MODELS**



**E. OUTER FAIRING SKIRT – '87-'13 MODELS**



**F. ROAD GLIDE FAIRING SUPPORT KIT – GLOSS BLACK**



**G. LOWER TRIPLE TREE COVER – CHROME**

## D. TIE-DOWN BRACKETS – CHROME

Simplify the process of securing your bike to a trailer or bike lift. These stylish chrome Tie-Down Brackets mount cleanly to the front fork cover and offer a secure method to connect tie-down straps. Moving the tie-down point from the handlebar to the triple-tree area reduces wear on the handlebar bushings and ensures a consistent easy-to-access mounting point. Just add Harley-Davidson® Ratchet Straps and Soft Hooks and you're ready to go.

**93500011** **\$59.95**  
Fits '14-later Touring models (except Road Glide® and Road King®). Does not fit Trike models.

**93500006** **\$59.95**  
Fits '00-later FLS, FLSTC and FLSTF/B, '95-later FLHR, FLHRC, '95-'13 FLHT, FLHTC, FLHX, FLHXSE/2/3 and '10-'13 FLHTCU, FLHTK and FLHTCUSE4/5/6/7. FLS, FLSTF and FLSTFB models without a windshield require separate purchase of Hardware Kit P/N 91800030.

## E. OUTER FAIRING SKIRT – GLOSS BLACK

Add a sinister touch to your batwing fairing. This classic gloss black skirt replaces the Original Equipment chrome or color-matched trim below the headlamp. The black skirt visually slims the fairing, and is the ideal finishing element on a blacked-out bike. Manufactured from Original Equipment components for superior fit and finish.

**57100227** **\$59.95**  
Fits '14-later Electra Glide® and Street Glide® models.

**46559-03** **\$99.95**  
Fits '87-'13 Touring models. Will not fit with Braided Brake Line P/N 45212-97B. Use Braided Brake Line P/N 46231-02A.

## F. ROAD GLIDE FAIRING SUPPORT KIT – GLOSS BLACK

Take your Road Glide in a different direction. Easy to install Fairing Mount replaces the Original Equipment chrome edition, and forms a seamless gloss black transition between a black engine guard and a dark color fairing. Kit includes gloss black left and right fairing support and matching engine guard clamps.

**47200278** **\$169.95**  
Fits '15-later Road Glide® models.

## G. LOWER TRIPLE TREE COVER – CHROME

This Lower Triple Tree Cover dresses up the unfinished underside of the triple tree for a complete custom look. The chrome-plated steel cover installs easily, concealing the brake splitter fitting.

**66050-03** **\$69.95**  
Fits '87-'13 Touring models. Will not fit with Braided Brake Line P/N 45212-97B. Use Braided Brake Line P/N 46231-02A.

TOURING

Notice: The prices appearing in this catalog are the manufacturer's suggested retail prices. Actual retail prices may vary.

# 458 TOURING & TRIKE

## Fairing Trim

### A. BATWING COLOR-MATCHED INNER FAIRING KIT

Add a custom touch to your motorcycle with a Color-Matched Inner Fairing and Fairing Cap. Designed to replace the Original Equipment matte black inner fairing, the color-matched finish offers a brilliant contrast to the gauge faces and accessory chrome instrument bezels.

#### Available to fit:

Fits '14-later Electra Glide® and Street Glide® models with handlebar mounted mirrors. Kit includes inner fairing, fairing cap, and media door.

Fits '14-later Street Glide models with fairing mounted mirrors. Kit includes inner fairing, fairing cap, and media door.

Fits '08-'13 Electra Glide and Street Glide models. Kit includes inner fairing and fairing cap.

Fits '04-'07 Electra Glide and Street Glide models. Kit includes inner fairing and fairing cap.

Fits '14-later Tri Glide® models. Kit includes inner fairing, fairing cap, and media door.

Fits '09-'13 Trike models. Kit includes inner fairing and fairing cap.

Fits '06-'13 Road Glide® models. Kit includes inner fairing, instrument housing and glove box doors.

See page 804-805 for a complete list of color options.



A. BATWING COLOR-MATCHED INNER FAIRING – '14-LATER MODELS



A. BATWING COLOR-MATCHED INNER FAIRING – '04-'13 MODELS

Notice: The prices appearing in this catalog are the manufacturer's suggested retail prices. Actual retail prices may vary.



NEW

## TOURING & TRIKE 459

Fairing Trim



**B. ROAD GLIDE COLOR-MATCHED INNER FAIRING KIT – '15-LATER MODELS  
(SHOWN WITH COLOR-MATCHED FAIRING AIR DUCT)**

**B. ROAD GLIDE® COLOR-MATCHED INNER FAIRING KIT**  
Add a custom touch to your motorcycle with a Color-Matched Inner Fairing and Fairing Cap. Designed to replace the Original Equipment matte black inner fairing, the color-matched finish offers a brilliant contrast to the gauge faces and accessory chrome instrument bezels.

**Available to fit:**

Fits '15-later Road Glide® models. Kit includes Color-Matched Inner Fairing Air Duct (sold separately).

Fits '06-'13 Road Glide models. Kit includes inner fairing, instrument housing and glove box doors.

See page 805 for a complete list of color options.

**Also available:**

**ROAD GLIDE COLOR-MATCHED FAIRING AIR DUCT**  
Add a custom touch to your motorcycle with a Color-Matched Inner Fairing Duct. Designed to replace the Original Equipment matte black inner fairing duct, the color-matched finish offers a brilliant contrast to the gauge faces and accessory chrome instrument bezels. Kit includes air duct baffle and actuator assembly.

Fits '15-later Road Glide models. Color-Matched Inner Fairing (sold separately).

See page 805 for a complete list of color options.



**B. ROAD GLIDE COLOR-MATCHED INNER FAIRING – '06-'13 MODELS**

Notice: The prices appearing in this catalog are the manufacturer's suggested retail prices. Actual retail prices may vary.

# 460 TOURING & TRIKE

Fairing Trim

## A. INNER FAIRING TRIM KIT

Add a touch of luxury and style to your dash. This complete kit dresses the inner fairing by surrounding the radio faceplate and front speakers with chrome. Self-adhesive bezels surround the gauges and the gloss black fascia completes the stylish look. Kit includes Gauge Trim Kit, Radio Faceplate Trim and two Front Speaker Trim Rings.

**61400199** **\$139.95**

Fits '14-later Electra Glide®, Street Glide® and Tri Glide® models. Does not fit CVO™ models or models equipped with accessory Boom!™ Audio Fairing Speakers.

## B. GAUGE TRIM KIT

A touch of chrome makes all the difference. These classic gauge bezels take just a few minutes to install, and add the beauty of chrome to your dash. Trim rings are formed to the gauge shapes and feature peel-and-stick adhesive backing for permanent installation. Kit includes chrome gauge trim rings and a gloss black mounting plate.

**61400200** **\$89.95**

Fits '14-later Electra Glide, Street Glide and Tri Glide models.

## C. RADIO TRIM BEZEL

This chrome faceplate trim accents the center section of the inner fairing and highlights the radio. Trim is formed to the radio surround and feature peel-and-stick adhesive backing for simple, permanent installation.

**61400201** **\$27.95**

Fits '14-later Electra Glide, Street Glide and Tri Glide models.



A. INNER FAIRING TRIM KIT



A. INNER FAIRING TRIM KIT



B. GAUGE TRIM KIT



C. RADIO TRIM BEZEL

Notice: The prices appearing in this catalog are the manufacturer's suggested retail prices. Actual retail prices may vary.



# TOURING & TRIKE 461

Fairing Trim



D. GAUGE BEZEL KIT – BURST COLLECTION

## D. GAUGE BEZEL KIT – BURST COLLECTION

Complete the custom look of the inner fairing. Burst Collection Gauge Bezels feature contrasting gloss black and sculpted machined surfaces that send reflections of light in all directions. The perfect match for Burst Speaker Trim, this easy to install gauge bezel kit includes two 4.0" Speedometer and Tachometer bezels and four 2.0" auxiliary gauge bezels.

**61400260** **\$226.95**  
Fits '96-'13 Electra Glide®, Street Glide®, Road Glide® and Trike models.

## E. SPEAKER TRIM – BURST COLLECTION

Sculpted machining sends reflections of light in all directions. The Burst Collection Speaker Trim features a rich black anodized finish that is machined to expose the highlights of raw aluminum. The contrasting cut-back spider makes a powerful visual statement, and works great with both traditional and contemporary customizing styles. Burst Collection Speaker Trim fits with both Original Equipment and Boom! Audio Speakers. Kit includes mounting hardware. Sold in pairs.

**76000307** Batwing Fairing. **\$139.95**  
Fits '96-'13 Electra Glide, Street Glide and Trike models with Original Equipment or Boom! Audio Fairing Mount Speakers. Does not fit '11-'12 FLHXSE. Does not fit Tour-Pak® or Fairing Lower Speakers.

**76000522** Tour-Pak Speakers. **\$221.95**  
Fits '96-'13 Electra Glide, Road Glide and Tri Glide® models with Original Equipment or Boom! Audio Tour-Pak mounted speakers.



D. GAUGE BEZEL KIT – BURST COLLECTION



E. FAIRING SPEAKER TRIM – BURST COLLECTION



E. TOUR-PAK SPEAKER TRIM – BURST COLLECTION

Notice: The prices appearing in this catalog are the manufacturer's suggested retail prices. Actual retail prices may vary.

# 462 TOURING & TRIKE

## Fairing Trim

### A. DIAMOND ICE GAUGE TRIM RINGS

These Gauge Trim Rings add a fine line of rhinestones around the perimeter of the gauge face, and a deluxe finishing touch to the dash. Chrome-plated rings feature adhesive backing for easy press-in-place installation.

**74736-10** 4" Gauge. **\$28.95**

Fits speedometers and tachometers on '05-'06 FXDC, '10-later FXDWG, '00-later XL, FXDL, FXDB, FXD, FXS, '13-later FXSB, FXSBSE, and '00-'13 Electra Glide®, Street Glide®, Road Glide® and Trike models. Sold individually.

**74737-10** 2" Gauge. **\$23.95**

Fits Voltmeter, Oil Pressure, Air Temp and Fuel Gauge on '86-'13 Electra Glide, Street Glide, Road Glide and Trike models. Sold individually.

**61400035** Dash Indicator Light. **\$19.95**

Fits '96-later FXS and '96-'13 Electra Glide, Street Glide and Trike models.

### B. DIAMOND ICE SPEAKER TRIM

Add a fine line of rhinestones around the perimeter of the Original Equipment speaker, and a little bit of flash to the dash and rear speaker boxes. These chrome-plated trim bezels mount directly over the speaker grills, and complement the complete line of Diamond Ice accessories. Easy to install, the kit includes left and right speaker trim and required mounting supplies.

**61400033** Front. **\$69.95**

Fits '96-'13 Electra Glide, Street Glide and Trike models with Original Equipment Speaker Grills. Does not fit '11-'12 FLHXSE or models equipped with Boom!™ Audio High Performance Speakers.

**61400034** Rear. **\$64.95**

Fits '98-'13 FLHTCU, FLHTK and FLHTCUTG models. Does not fit models equipped with Boom! Audio High Performance Speakers.



A. DIAMOND ICE GAUGE TRIM RINGS



A. DIAMOND ICE GAUGE TRIM RINGS



B. DIAMOND ICE SPEAKER TRIM – FRONT

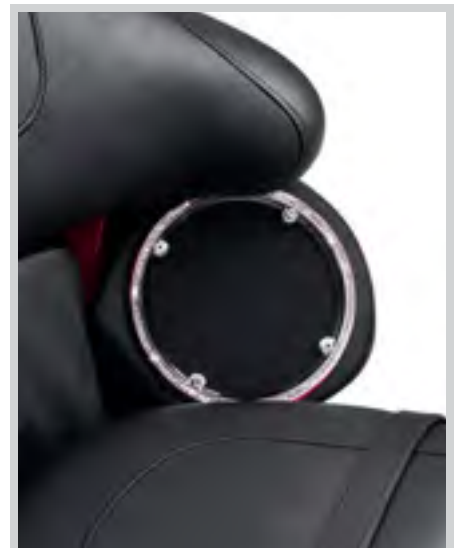

B. DIAMOND ICE SPEAKER TRIM – REAR

*Notice: The prices appearing in this catalog are the manufacturer's suggested retail prices. Actual retail prices may vary.*



# TOURING & TRIKE 463

Fairing Trim



**C. INNER FAIRING TRIM KIT  
(SHOWN WITH FAIRING DASH PAD)**



**C. INNER FAIRING TRIM KIT**



**D. CHROME INSTRUMENT BEZELS  
(SHOWN WITH FAIRING DASH PAD)**

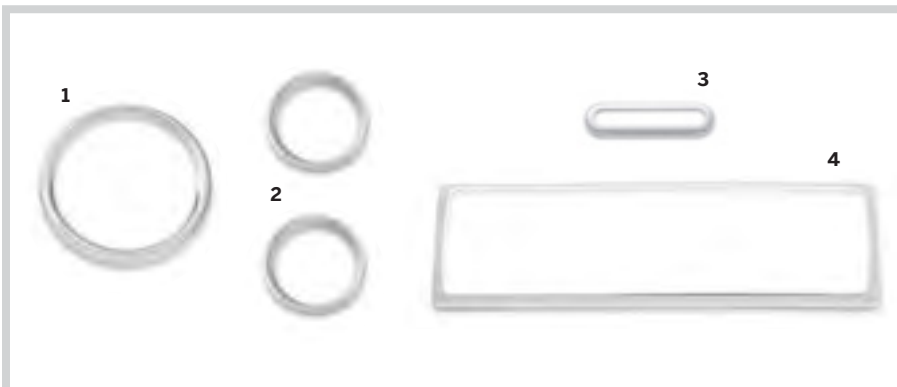

**D. CHROME INSTRUMENT BEZELS**

## C. INNER FAIRING TRIM KIT

Add a touch of luxury and style to your dash. This complete kit dresses the inner fairing by surrounding the radio faceplate and gauges with chrome. Package includes: Bar & Shield Radio Faceplate, two 4.0" Speedo/Tach Gauge Bezels, four 2.0" Gauge Bezels, Radio and Gauge Faceplate Trim and two Front Speaker Trim Rings.

**96396-09** **\$119.95**  
Fits '06-'13 Electra Glide®, Street Glide® and Trike models equipped with the Advanced Audio System Radio.

## D. CHROME INSTRUMENT BEZELS

A touch of chrome makes all the difference. These bezel covers take just seconds to install and add the beauty of chrome to your dash. Available to fit all the fairing-mount gauges, these easy-to-install, chrome-plated formed rings feature peel-and-stick adhesive backing for permanent installation.

### 1. 4" Chrome Gauge Bezel

**74541-00** **\$16.95**  
Fits Speedometer and Tachometer Gauges on '00-later XL, '00-'13 Dyna® (except FLD and FXDWG), '13-later FXSB, FXSBSE, and '00-'13 Electra Glide, Street Glide, Road Glide® and Trike Models. Sold individually.

### 1. 4" Chrome Gauge Bezel

**74560-96** **\$22.95**  
Fits Speedometer and Tachometer on '96-'99 FLHT and '98-'99 FLTR models. Sold in pairs.

### 2. 2" Chrome Gauge Bezel

**74550-92T** **\$18.95**  
Fits Voltmeter, Oil Pressure, Air Temp and Fuel Gauge on '86-'13 Electra Glide, Street Glide, Road Glide and Trike models (pair). Sold in pairs.

### 3. Chrome Indicator Lamp Bezel Cover

**74562-98** **\$16.95**  
Fits '96-'13 Electra Glide, Street Glide and Trike models.

### 4. Chrome Radio Trim Bezel

**74596-00** **\$17.95**  
Fits '98-'05 FLHTC and FLHTCU models. Also fits FLHT models with accessory radio.

# 464 TOURING & TRIKE

## Fairing Trim

### A. FAIRING DASH PAD

Original Equipment on the Screamin' Eagle® Electra Glide® Ultra model, this custom dash pad adds a recessed cockpit look to the inner fairing. The smooth top-stitched leather visor features a brilliant chrome-plated gauge eyebrow for a custom touch.

**58262-05** **\$174.95**  
Fits '97-'13 Electra Glide®, Street Glide® and Trike models.



A. FAIRING DASH PAD

### B. RADIO AND GAUGE FACEPLATE TRIM

This chrome faceplate trim is installed on the raised section of the inner fairing and highlights the air temperature gauge, oil pressure gauge, indicator lamp and the radio. Trim can be installed with Chrome Instrument Gauge Bezels P/N 74550-92T for an added custom touch.

**74612-06** **\$28.95**  
Fits '96-'13 Electra Glide, Street Glide and Trike models.



B. RADIO AND GAUGE FACEPLATE TRIM

### C. RADIO FACEPLATE TRIM

This brushed aluminum radio faceplate features self-adhesive installation on any model equipped with the Advanced Audio System Radio.

**77142-06** Skull. **\$16.95**  
Fits '06-'13 Touring models equipped with Advanced Audio System Radio.

**77143-07** Bar & Shield. **\$16.95**  
Fits '06-'13 Touring models equipped with Advanced Audio System Radio.

### D. SWITCH PANEL ACCENT

Dress for success. This handsome trim element frames the ignition and flanking rocker switches in chrome. Simple to install with peel-and-stick adhesive, the kit also includes inserts to cover inactive switch openings. Complete the chrome look with optional Radio Trim P/N 74612-06 and Chrome Gauge Bezels.

**61400001** **\$54.95**  
Fits '96-'13 Electra Glide, Street Glide and Trike models.



C. SKULL RADIO FACEPLATE TRIM



C. SKULL AND BAR & SHIELD LOGO RADIO FACEPLATE TRIM



D. SWITCH PANEL ACCENT

Notice: The prices appearing in this catalog are the manufacturer's suggested retail prices. Actual retail prices may vary.



# TOURING & TRIKE 465

Fairing Trim



**E. SPEAKER TRIM – FRONT**  
(\*14-LATER MODELS)



**E. SPEAKER TRIM – REAR**  
(\*14-LATER MODELS)



**E. SPEAKER TRIM – FRONT**  
(\*96-'13 MODELS)



**E. SPEAKER TRIM – REAR**  
(\*98-'13 MODELS)



**F. BOOM! AUDIO SPEAKER TRIM – FRONT**  
(\*14-LATER MODELS)



**F. BOOM! AUDIO SPEAKER TRIM – REAR**  
(\*14-LATER MODELS)



**F. BOOM! AUDIO SPEAKER TRIM – FRONT**  
(\*98-'13 MODELS)



**F. BOOM! AUDIO SPEAKER TRIM – REAR**  
(\*98-'13 MODELS)

## E. SPEAKER TRIM – CHROME

When it comes to style, this chrome-plated trim makes your speakers look as good as they sound. These bezels mount directly over the Original Equipment speaker grills, and add a subtle spot of chrome. Easy to install, the kit includes left and right speaker trim and required mounting supplies.

**61400197** Front. **\$39.95**  
Fits '14-later Electra Glide®, Street Glide® and Tri Glide® models with Original Equipment speakers. Does not fit CVO™ FLHTKSE models or models equipped with Boom!™ Audio High Performance Speakers.

**61400194** Rear. **\$39.95**  
Fits '14-later FLHTCU, FLHTCUL, FLHTK, FLHTKL and FLHTCUTG models with Original Equipment Tour-Pak® speakers. Does not fit CVO FLHTKSE, FLTRUSE or models equipped with Boom! Audio High Performance Speakers.

**74604-99** Front. **\$32.95**  
Fits '96-'13 Electra Glide, Street Glide and Trike models with Original Equipment Speaker Grills. Does not fit '11-'13 FLHXSE, '12-'13 FLHTCUSE or models equipped with Boom! Audio High Performance Speakers.

**74584-99** Rear. **\$35.95**  
Fits '98-'13 FLHTCU, FLHTK and FLHTCUTG models. Does not fit '12-'13 FLHTCUSE or models equipped with Boom! Audio High Performance Speakers.

## F. BOOM! AUDIO SPEAKER TRIM

Add a touch of chrome to your Boom! Audio Speakers. Chrome trim rings outline the speaker and accent the rich black speaker grill. Easy to install, the trim rings complement available chrome fairing trim. Sold in pairs.

**61400193** Front. **\$44.95**  
Fits '14-later Electra Glide, Street Glide and Tri Glide models with Boom! Audio Fairing Mount Speakers.

**61400210** Rear. **\$44.95**  
Fits '14-later Electra Glide, Street Glide and Tri Glide models with Rear Speaker Pods and Boom! Audio Tour-Pak Rear Speakers.

**76000156** Front. **\$39.95**  
Fits '98-'13 Electra Glide, Street Glide and Trike models equipped with Boom! Audio Fairing Mount Speakers.

**76000157** Rear. **\$39.95**  
Fits '98-'13 Touring models with Rear Speaker Pods and Boom! Audio Tour-Pak Rear Speakers.

# 466 TOURING & TRIKE

## Fairing Trim

### A. FAIRING MOUNT MIRRORS – BLACK

Fairing Mount Mirrors offer a truly innovative look from the traditional handlebar-mounted mirrors. Mounting just inside the inner fairing, the molded plastic mirror housings complement the contours of the batwing fairing. They provide a wide range of adjustability and feature convex mirror glass that maximizes your field of view. The Bar & Shield logo is carefully laser-etched on each mirror glass. Kit includes necessary hardware, instructions and mounting template for easy installation.

**56000076** **\$99.95**

Fits '14-later Electra Glide® and Tri Glide® models. Original Equipment on Street Glide® models.

**91945-98B** **\$99.95**

Fits '96-'13 Electra Glide and Trike models. Original equipment on Street Glide models.



A. FAIRING MOUNT MIRRORS – BLACK

### B. FAIRING MOUNT MIRRORS – CHROME

Add a splash of chrome to the batwing inner fairing. These Fairing Mount Mirrors de-clutter the handlebar and add a contemporary aero style to your ride. The attractive chrome housing provides a custom look, and the convex mirror and wide range of adjustment maximizes your field of view. A direct bolt-on replacement for Original Equipment fairing mount mirrors, the kit includes the hardware and mounting template required for easy and accurate installation on many models.

**56000077** **\$134.95**

Fits '14-later Electra Glide, Street Glide and Tri Glide models.

**56000029** **\$134.95**

Fits '96-'13 Electra Glide, Street Glide and Trike models. Original Equipment on '12 FLHXSE models.



B. FAIRING MOUNT MIRRORS – CHROME

### C. ILLUMINATED FAIRING MOUNT MIRROR COVERS – CHROME

Add auxiliary LED turn signals and a splash of chrome to the inner fairing. The perfect finishing touch to a fully-dressed inner fairing, these chrome-plated mirror housings feature fast-acting amber LED turn signals at the outer edge. Side turn signals attract attention from the drivers around you, and the plug-in, no-splice design simplifies installation.

**56000084** **\$134.95**

Fits '14-later Touring and Trike models with fairing mount mirrors. Does not fit with Split Vision Fairing Mount Mirrors P/N 92085-10.

**92600-10** **\$134.95**

Fits '06-'13 FLHX, FLHXSE and FLHXXX models, and other Electra Glide models equipped with Fairing Mount Mirrors P/N 91945-98B. Does not fit with Split Vision Fairing Mount Mirrors P/N 92085-10.



C. ILLUMINATED FAIRING MOUNT MIRROR COVERS – CHROME

### D. SPLIT VISION FAIRING MOUNT MIRRORS

See even more of the world that you just passed. These exclusive-design Split Vision Mirrors minimize blind spots and provide a wide panoramic rear view of the left and right lane, and the road behind you. The mirrors feature a large primary panel for normal view, and a second outboard convex panel for a wider field of vision. Slightly larger than the standard-view Fairing Mount Mirrors, these Split Vision Mirrors offer the same full range of adjustability. A direct bolt-on replacement for standard-view Fairing Mount Mirrors, the kit also includes the hardware and mounting template required for easy and accurate installation on many models.

**92085-10** **\$109.95**

Fits '96-'13 Electra Glide, Street Glide and Tri Glide models.

Does not fit with Chrome Fairing Mount Mirror Covers P/N 91924-09, Illuminated Chrome Mirror Covers P/N 92600-10 or Fairing Mount Mirror Covers P/N 92200001.



D. SPLIT VISION FAIRING MOUNT MIRRORS

### E. FAIRING MOUNT MIRROR COVERS – CHROME

Add a splash of chrome to the inner fairing. The chrome-plated housings wrap around the back and side of the Fairing Mount Mirrors, presenting a clean, uncluttered profile. The perfect finishing touch to a fully dressed inner fairing.

**91924-09** **\$74.95**

Fits '06-'13 FLHX, FLHXSE and FLHXXX models, and other Electra Glide models equipped with Fairing Mount Mirrors P/N 91945-98B. Does not fit with Split Vision Fairing Mount Mirrors P/N 92085-10.

D. SPLIT VISION FAIRING MOUNT MIRRORS

E. FAIRING MOUNT MIRROR COVERS – CHROME

*Notice: The prices appearing in this catalog are the manufacturer's suggested retail prices. Actual retail prices may vary.*



# TOURING & TRIKE 467

Console Trim



NEW

**F. GLOSS BLACK CONSOLE KIT**  
(70900463 SHOWN)  
(SHOWN WITH BURST FUEL DOOR)



NEW

**F. GLOSS BLACK CONSOLE KIT**  
(70900501 SHOWN)  
(SHOWN WITH BLACK FUEL DOOR)

## F. GLOSS BLACK CONSOLE KIT

Lead the way to the dark side. This blacked-out Console Kit includes the major components required to change the chrome console to a dark custom look. Manufactured from Original Equipment components for superior fit and finish, the kit includes black console, gasket, and hardware. Available for models with or without 7-pin DIN headset connector. Add your choice of Fuel Door (sold separately) to set your bike apart from the crowd.

Fits '08-later Electra Glide®, Street Glide®, Road Glide® and Trike models with center fill tank.

**70900463** Without CB Communications Port. **\$299.95**

**70900501** With CB Communications Port. **\$299.95**

## G. FUEL TANK CONSOLE – CHROME

Visually stretch the look of the fuel tank with this full-length tank console. This die-cast console has been polished and chrome-plated to a mirror-like finish, and is capped off with a satin and gloss black Bar & Shield insert. The kit is a direct replacement for the Original Equipment console, and can be used with the stock fuel door, or accented with any of the Harley-Davidson® accessory collection doors. Kit includes all necessary mounting hardware.

**71288-03A** **\$204.95**

Fits '97-'07 FLHT, FLHTC and '98-'07 FLTR models.

Installation requires the use of a Road King® style seat. Will not fit FLHT or FLHTC models equipped with a CB Intercom Kit.

## H. CB INTERCOM CHROME CONSOLE

Add a sweep of style to your fuel tank. This chrome-plated console is a direct replacement for the Original Equipment black finish CB console. The easy-to-install console features a plug-in connection for the CB microphone.

**77140-05** Fits '03-'07 FLHTCUI models. **\$84.95**

## I. PERSONAL ACCENTS CONSOLE INSERT COLLECTIONS

As a rider, there is probably no part of your bike you see more than your dash and tank console. And thanks to Personal Accents Inserts, it's also the easiest part of your bike to customize. Console inserts are available in a stylish assortment of finishes that blend with your personal direction. Matching Tour-Pak® Inserts are also available to complete the custom transformation.

See style and fitment information in Color-Shop section of this catalog.



**G. FUEL TANK CONSOLE – CHROME**



**H. CB INTERCOM CHROME CONSOLE**



**I. PERSONAL ACCENTS CONSOLE INSERT COLLECTIONS – RAISED SKULL**

Notice: The prices appearing in this catalog are the manufacturer's suggested retail prices. Actual retail prices may vary.

# 468 TOURING & TRIKE

## Console Trim

### A. FUEL TANK CONSOLE DOOR – BURST COLLECTION

Rich black surfaces and prismatic machined aluminum define the Burst Collection Fuel Door. The race-track ridges and the inner spider design make a powerful visual statement, and are the perfect match to the available Gloss Black Console and Smooth Push Button accessories. Kit includes mounting hardware.

**70900474** **\$139.95**

Fits '08-later Electra Glide®, Street Glide®, Road Glide® and Trike models with center fill tank.



**A. FUEL TANK CONSOLE DOOR – BURST COLLECTION**



**B. FUEL TANK CONSOLE DOOR – GLOSS BLACK**

### B. FUEL TANK CONSOLE DOOR – GLOSS BLACK

The gloss black fuel door is the perfect match for the Gloss Black Console Kit. The easy-to-install fuel door replaces the stock door, and reuses Original Equipment mounting hardware.

**70900465** **\$54.95**

Fits '08-later Electra Glide, Street Glide, Road Glide and Trike models with center fill tank.

### C. WILLIE G SKULL FUEL TANK CONSOLE DOOR

Add a little attitude to your ride. Styled to complement Harley-Davidson® Skull accessory items, the menacing raised skull with black-filled eyes leaps from a field of chrome. The surrounding “Harley-Davidson Motorcycles” script is the perfect finishing touch. These easy-to-install Fuel Doors replace the stock door, and reuse Original Equipment mounting hardware and lock.

**61308-09** **\$36.95**

Fits '08-later Electra Glide, Street Glide, Road Glide and Trike models with center fill tank.

**61374-04** **\$36.95**

Fits '92-'07 Electra Glide, Tour Glide™ and Road Glide models.



**C. WILLIE G SKULL FUEL TANK CONSOLE DOOR**



**D. NUMBER ONE SKULL FUEL TANK CONSOLE DOOR**

### D. NUMBER ONE SKULL FUEL TANK CONSOLE DOOR

The sinister Harley-Davidson #1 Skull logo dresses for a night on the town. This complete die-cast aluminum collection has been polished and chrome-plated to a brilliant shine, then finished with a contrasting black-filled Dark Custom™ Skull logo. These easy-to-install Fuel Doors replace the stock door, and reuse Original Equipment mounting hardware and lock.

**62378-10** **\$36.95**

Fits '08-later Electra Glide, Street Glide, Road Glide and Trike models with center fill tank.

### E. “LIVE TO RIDE” FUEL TANK CONSOLE DOOR

“Live To Ride, Ride to Live.” It has become the motto of the Harley-Davidson nation, accompanying riders over millions of miles of travel. This collection is a tribute to that way of life. These easy-to-install Fuel Doors replace the stock door, and reuse Original Equipment mounting hardware and lock. Available in your choice of gold or chrome finish.

Fits '08-later Electra Glide, Street Glide, Road Glide and Trike models with center fill tank.

**61335-09** Gold. **\$39.95**

**61300049** Chrome. **\$36.95**

Fits '92-'07 Electra Glide, Tour Glide1 and Road Glide models.

**61286-92T** Gold. **\$39.95**



**E. “LIVE TO RIDE” FUEL TANK CONSOLE DOOR – GOLD**



**E. “LIVE TO RIDE” FUEL TANK CONSOLE DOOR – CHROME**

### F. FLAMES FUEL TANK CONSOLE DOOR

Ever since they began emerging on gas tanks a few decades ago, flames have been a symbol of custom styling. Now, Harley-Davidson continues the tradition with the Flames Collection. These easy-to-install Fuel Doors replace the stock door, and reuse Original Equipment mounting hardware and lock. Available in your choice of gold or chrome finish.

Fits '08-later Electra Glide, Street Glide, Road Glide and Trike models with center fill tank.

**61319-09** Gold. **\$39.95**

**61300050** Chrome. **\$36.95**

Fits '92-'07 Electra Glide, Tour Glide and Road Glide models.

**61359-98** Gold. **\$39.95**



**F. FLAMES FUEL TANK CONSOLE DOOR – GOLD**



**F. FLAMES FUEL TANK CONSOLE DOOR – CHROME**

*Notice: The prices appearing in this catalog are the manufacturer's suggested retail prices. Actual retail prices may vary.*



# TOURING & TRIKE 469

Console Trim



**G. SKULL & CHAIN FUEL TANK CONSOLE DOOR – CHROME**



**H. SKULL & CHAIN FUEL TANK CONSOLE DOOR – SMOKEY CHROME**



**I. DIAMOND ICE FUEL TANK CONSOLE DOOR**



**J. SMOOTH PUSH-BUTTON FUEL TANK CONSOLE DOOR RELEASE – CHROME**



**J. SMOOTH PUSH-BUTTON FUEL TANK CONSOLE DOOR RELEASE – GLOSS BLACK**



**K. PUSH-BUTTON FUEL TANK CONSOLE DOOR RELEASE**



**G. SKULL & CHAIN FUEL TANK CONSOLE DOOR – CHROME**

Links to the dark side. This mirror-chrome collection stands out in a crowd, with a contrasting 3-D chain that rims the surface and surrounds the distinctive raised Willie G Skull. Select from the traditional skull design or for a little added flash, choose the version with the bright rhinestone encrusted jaw line. Either way, this complete collection is a tribute to the mechanical side of your ride. These easy-to-install fuel doors replace the stock door, and reuse Original Equipment mounting hardware and lock.

Fits '08-later Electra Glide®, Street Glide®, Road Glide® and Trike models with center fill tank.

<b>61100035</b>	Skull.	<b>\$59.95</b>
<b>61100009</b>	Jeweled Skull.	<b>\$59.95</b>

**H. SKULL & CHAIN FUEL TANK CONSOLE DOOR – SMOKEY CHROME**

The sinister smokey-chrome finish is the ideal complement to a blacked-out ride and the contrasting 3-D chain rims the surface and surrounds the distinctive Willie G Skull with black-filled eyes. These easy-to-install fuel doors replace the stock door and reuse Original Equipment mounting hardware and lock.

Fits '08-later Electra Glide, Street Glide, Road Glide and Trike models with center fill tank.

<b>61100033</b>	Skull.	<b>\$59.95</b>
-----------------	--------	----------------

**I. DIAMOND ICE FUEL TANK CONSOLE DOOR**

This easy-to-install Fuel Door sets the rhinestone-laden Bar & Shield medallion "front and center" and attracts the maximum attention.

**61307-10** **\$59.95**  
Fits '08-later Electra Glide, Street Glide, Road Glide and Trike models with center fill tank.

**J. SMOOTH PUSH-BUTTON FUEL TANK CONSOLE DOOR RELEASE**

Add stop-and-go speed at the gas pump. The smooth button replaces the lock for push-to-open convenience. No more digging in your pocket for the key. The large button is easy to operate while wearing gloves.

**53919-04A** Chrome. **\$29.95**  
Fits '92-later Electra Glide, Street Glide, Tour Glide™, Road Glide and Trike models with center fill tank.

**90300096** Gloss Black. **\$29.95**  
Fits '92-later Electra Glide, Street Glide, Tour Glide, Road Glide and Trike models with center fill tank.

**K. PUSH-BUTTON FUEL TANK CONSOLE DOOR RELEASE**

An added convenience you'll appreciate at fuel stops. This lockable replacement for your stock fuel tank console door lock allows the door to be opened without a key by depressing the center button of the lock. For basic security, it can be locked with any barrel key.

**53842-00C** **\$29.95**  
Fits '92-later Electra Glide, Street Glide, Tour Glide, Road Glide and Trike models with center fill tank.

TOURING

Notice: The prices appearing in this catalog are the manufacturer's suggested retail prices. Actual retail prices may vary.

# 470 TOURING & TRIKE

## Console Trim

### A. FORK LOCK COVER

This chrome-plated aluminum die-cast cover finishes the look of the Road King® fork lock. The protective cover adds a finishing touch to the handlebar cover and the smooth domed lid flips up to provide access to the fork lock. Includes chrome-plated flush-mount hardware.

**71790-05** Fits '94-later FLHR models. **\$49.95**



A. FORK LOCK COVER – CLOSED



A. FORK LOCK COVER – OPEN

### B. GAUGE VISOR RING

A touch of chrome makes all the difference. These easy-to-install trim rings feature an integrated eyebrow visor to shield the gauge face from the sun's glare. Self-adhesive backing for secure mount.

**74661-04** 5" Gauge. **\$27.95**  
Fits '99-'08 FXDWG, '99-'07 Road King and '99-later Softail® models (except FXS, FXSB, FXSBSE, FLSTNSE, FXST-Aus, FXSTD, FXCW, FXCWC, FLSTFSE and Softail models equipped with Chrome Console P/N 67575-04).

**74662-04** 4" Gauge. **\$25.95**  
Fits '99-later XL, '99-'13 Dyna® (except FXDWG), FXS, FXSB, FXSBSE, FXST-Aus and '98-'13 Road Glide® models.



B. GAUGE VISOR RING



C. DIAMOND ICE TRIM RING – 5" GAUGE

### C. DIAMOND ICE GAUGE TRIM RING

This Gauge Trim Ring adds a fine line of rhinestones around the perimeter of the gauge face and a deluxe finishing touch to the dash. Chrome-plated steel ring features adhesive backing for easy press-in-place installation.

**74548-10** 5" Gauge. **\$29.95**  
Fits '99-'08 FXDWG, '99-later FXDF, FLD, '07-later FXDC, '99-'07 Road King and '99-later Softail models (except FXS, FXSB, FXSBSE, FXSTD, FXCW, FXCWC, FLSTFSE, FLSTNSE, FXST-Aus and Softail models equipped with chrome Console P/N 67575-04 or 71208-07).

### D. "BULLSEYE" CONSOLE NUT

Replace your plain stock chrome acorn nut with this special chrome-plated Console Nut that features a machined "Bullseye" design highlighted with black accent rings.

**94755-99** **\$7.95**  
Fits '90-'95 and '00-later Softail models (except FXS, FXSB, FXSBSE, FXSTD, FXCW, FXCWC, FLSTSB, FXST-AUS and '09-later FLS and FLSTC), '93-'03 FXDWG, '94-'07 FLHR models.



D. "BULLSEYE" CONSOLE NUT

### E. "BULLSEYE" CONSOLE WASHER

As a replacement for the plain stock washer on Road King models, this chrome-plated billet Console Washer features a three dimensional, machined-in "Bullseye" design, highlighted with black accent rings. A stainless steel mounting screw is provided and, once installed, is hidden under the black center insert with Bar & Shield logo.

**94753-99** **\$19.95**  
Fits '94-'07 FLHR (except FLHRS) models and '84-later Softail tank panels with screw mounts.



E. "BULLSEYE" CONSOLE WASHER

### F. RIDER CUP HOLDER

Shaped to blend with the contours of your Harley-Davidson® motorcycle, this unique cup holder is easy to reach without cluttering the handlebar. The attractive chrome mount securely attaches to the frame downtube, and sweeps rearward to support the cup holder. The soft-touch insulated holder flexes to grip the beverage and features a perforated bottom to drain away rain water. Kit includes model-specific clamp, support rod, cup holder and all required mounting hardware.

**50700001** **\$54.95**  
Fits '09-later Touring and Trike models. Does not fit '14-later Touring or Trike models equipped with Fairing Lowers.



F. RIDER CUP HOLDER

*Notice: The prices appearing in this catalog are the manufacturer's suggested retail prices. Actual retail prices may vary.*



# TOURING & TRIKE 471

Chassis Trim – Rear End



**G. LOWER BELT GUARD COVER – CHROME**  
(60491-02A SHOWN)

## G. LOWER BELT GUARD COVER – CHROME

Dress your lower belt guard in chrome. This polished and chrome-plated metal guard is formed to fit over the Original Equipment belt guard for easy installation.

**60408-09** Fits '09-later Touring models. **\$79.95**

**60491-02A** Fits '97-'08 Touring models. **\$84.95**

## H. REAR SPROCKET BOLT COVER KIT

These chrome-plated covers with internal spring clips hide the Original Equipment sprocket bolts for a clean, custom look. Set of 5 covers.

**43876-04** Fits '93-later Softail®, '99-later Touring and '04-later XL models with Original Equipment .4375" hex head sprocket mounting bolts (.625" hex across the flats). **\$38.95**

## I. DOME WHEEL CENTER COVER KIT

These chrome-plated hubcaps add style and depth to the Trike's rear wheels. The snap-fit covers have no visible fasteners for a clean, custom look.

**40900044** Fits '09-later Trike models. Installation on Original Equipment wheel requires removal of wheel and factory center medallion. **\$39.95**

## J. WHEEL CENTER COVER KIT

These chrome-plated hubcaps add style and depth to the Trike's rear wheels. The snap-fit covers have no visible fasteners for a clean, custom look.

**83841-09** Fits '09-later Trike models. Installation on Original Equipment wheel requires removal of wheel and factory center medallion. **\$41.95**



**G. LOWER BELT GUARD COVER**  
(60491-02A SHOWN)



**H. REAR SPROCKET BOLT COVER KIT**



**I. DOME WHEEL CENTER COVER KIT**



**J. WHEEL CENTER COVER KIT**

*Notice: The prices appearing in this catalog are the manufacturer's suggested retail prices. Actual retail prices may vary.*

## 472 TOURING & TRIKE

Chassis Trim – Rear End

### A. FENDER TRIM KIT – CHROME

This Chrome Fender Trim Kit dresses the opening of the wheel well and adds a touch of elegance to the rear of the bike. With no visible fasteners, the trim accentuates the shape and protects the painted edge of the rear fender from minor stone chips. Self-adhesive backing for easy installation.

**83812-09** **\$104.95**  
Fits '09-later FLHTCUTG and '10-'11 FLHXXX models.



A. FENDER TRIM KIT – CHROME

### B. EXHAUST TRIM

This chrome-plated accent piece trims the exhaust openings in the trunk fascia and adds a touch of brightwork to the rear of the bike. Easy to install with no visible fasteners, the formed steel trim features pre-applied high-temp adhesive backing for a clean, uncluttered look.

**83843-09** **\$41.95**  
Fits '09-later FLHTCUTG and '10-'11 FLHXXX models.



B. EXHAUST TRIM

### C. TRUNK GUARD

Unique rear guard wraps around the bodywork to protect your finish from damage. Lightweight steel tubing incorporates high-quality welded joints and is hand-polished and chrome-plated for a brilliant finish. Kit includes all necessary mounting hardware for bolt-on installation.

**83825-09B** **\$249.95**  
Fits '09-later FLHTCUTG and '10-'11 FLHXXX models.

**49000069** **\$249.95**  
Fits '15-later FLRT models.



C. TRUNK GUARD – TRI GLIDE

NEW



C. TRUNK GUARD – FREEWHEELER

*Notice: The prices appearing in this catalog are the manufacturer's suggested retail prices. Actual retail prices may vary.*



# TOURING & TRIKE 473

Chassis Trim – Rear End

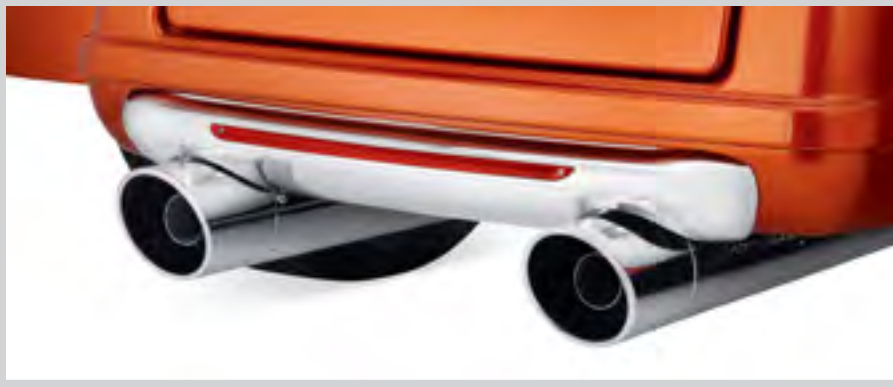

**D. ILLUMINATED FASCIA ACCENT TRIM – RED LENS**

## D. ILLUMINATED FASCIA ACCENT TRIM

Sweeping chrome trim dresses the trunk fascia for a distinctive yet functional look. The inset LED light bar glows as a running lamp when the ignition is on and functions as an auxiliary red lamp when the brakes are applied. Available with smoked or red LED lens to match your customizing direction. Can be installed on models equipped with Trunk Guard.

Fits '14-later Tri Glide® models. Will not fit with Exhaust Trim P/N 83843-09.

<b>68000128</b>	Smoked Lens.	<b>\$249.95</b>
<b>68000129</b>	Red Lens.	<b>\$249.95</b>

Fits '09-'13 Trike models. Will not fit with Exhaust Trim P/N 83843-09.

<b>84028-11</b>	Smoked Lens.	<b>\$239.95</b>
<b>84023-11</b>	Red Lens.	<b>\$249.95</b>



**D. ILLUMINATED FASCIA ACCENT TRIM – RED LENS**



**D. ILLUMINATED FASCIA ACCENT TRIM – SMOKED LENS**

## E. TRIKE MUD FLAPS – TRI-GLIDE® LOGO

Custom-fit Mud Flaps protect the sides of your Trike's trunk box from spray and road debris and keep the finish clean and free of mud and tar buildup. Custom molded for a perfect fit, these matte black mud flaps feature a raised light gray "Tri-Glide" script logo. Kit includes left and right mud flap, reinforcing brackets and mounting hardware.

<b>59600018</b>		<b>\$59.95</b>
-----------------	--	----------------

Fits '09-later FLHTCUTG and '10-'11 FLHXXX models.

## F. STUDED REAR FENDER MUD FLAP

Black mud flap with accenting decorative studs.

<b>59230-88</b>		<b>\$29.95</b>
-----------------	--	----------------

Fits '08-earlier FLHT, FLHS, FLHRC, FLT, FLTR, '86-'90 FLST, '86-'06 FLSTF and '93-'96 FLSTN models. (Does not fit '09-later Touring or models with rear bumper rail.)

## G. ROAD KING® CLASSIC REAR FENDER MUD FLAP

Sturdy, black rubber mud flap features the Road King® Classic logo.

<b>59385-98</b>		<b>\$29.95</b>
-----------------	--	----------------

Fits '98-'08 FLHRC and FLTR models.

<b>59386-98</b>		<b>\$29.95</b>
-----------------	--	----------------

Fits '79-'08 FLH, FLHT, FLT, '98-'08 FLTR, '79-'93 FLHS and '94-'08 FLHR. (Does not fit FLHX models.)



**E. TRIKE MUD FLAPS – TRI-GLIDE LOGO**



**E. TRIKE MUD FLAPS – TRI-GLIDE LOGO**



**F. STUDED REAR FENDER MUD FLAP**



**G. ROAD KING CLASSIC REAR FENDER MUD FLAP**

Notice: The prices appearing in this catalog are the manufacturer's suggested retail prices. Actual retail prices may vary.

## 474 TOURING & TRIKE

Chassis Trim – Rear End

### A. FENDER SUPPORT KIT – GLOSS BLACK

Manufactured from Original Equipment components to ensure superior fit and finish, the gloss black Fender Support Kit replaces the Original Equipment cast and chrome fender support system and continues the dark look to the area between and behind the saddlebags. The ideal finishing touch for your “blacked-out” Touring bike, these covers are the perfect complement to the optional gloss black Passenger Sissy Bars, Luggage Racks, Tour-Pak mounting racks and Docking Hardware Kits. Kit includes gloss black left and right supports and docking hardware slot fillers.

**90201206**

**\$299.95**

Fits '14-later Touring models.

### B. FENDER STRUT COVERS – GLOSS BLACK

Manufactured from Original Equipment components to ensure superior fit and finish, the gloss black Fender Strut Covers conceal the cast fender struts and continue the dark look to the area behind the saddlebags. The ideal finishing touch for your “blacked-out” Touring bike, these covers are the perfect complement to the optional gloss black Passenger Sissy Bars, Stealth Luggage Rack and Docking Hardware Kits.

**47498-09**

**\$109.95**

Fits '09-'13 Touring models (except models equipped with rigid-mounted Tour-Pak® luggage.)

NEW



A. FENDER SUPPORT KIT – GLOSS BLACK

NEW



A. FENDER SUPPORT KIT – GLOSS BLACK

NEW



B. FENDER STRUT COVERS – GLOSS BLACK

*Notice: The prices appearing in this catalog are the manufacturer's suggested retail prices. Actual retail prices may vary.*



# TOURING & TRIKE 475

Chassis Trim – Rear End

## C. CVO™ STYLE REAR FENDER SYSTEM

Complete with integrated LED brake lights, turn indicators and tail lights, this custom rear fascia and fender kit keeps the back of your bike clean, classy and simple. Originally featured on CVO™ Touring models, this kit includes everything you need to smoothly blend the shape of the rear fender into the saddlebags and hide the saddlebag mounting structure.

Fits '14-later Touring (except FLHRC and CVO models). Does not fit models equipped with Saddlebag Guard Rails P/N 90200561.

**59500246** Domestic (US-only) – Primed. **\$999.95**

**59500245** International (Australia, Brazil, Canada, Europe, Japan and Mexico) – Primed. **\$999.95**

Fits '09-'13 Touring models (except FLHRC). FLHTC and FLHTCU models require separate purchase of Saddlebag Support Kit P/N 90881-09.

**59500105BEO** Domestic – Primed. **\$999.95**

**59500122BEO** International – Primed. **\$999.95**



C. CVO STYLE REAR FENDER SYSTEM – WITH CUSTOM VIVID BLACK PAINT ('09-'13 DOMESTIC MODELS)



NEW

C. CVO STYLE REAR FENDER SYSTEM – '14-LATER DOMESTIC MODELS



NEW

C. CVO STYLE REAR FENDER SYSTEM – '14-LATER INTERNATIONAL MODELS



C. CVO STYLE REAR FENDER SYSTEM – '09-'13 DOMESTIC MODELS



C. CVO STYLE REAR FENDER SYSTEM – '09-'13 INTERNATIONAL MODELS

TOURING

Notice: The prices appearing in this catalog are the manufacturer's suggested retail prices. Actual retail prices may vary.



GENUINE MOTOR PARTS & ACCESSORIES



2015

## SCREAMIN' EAGLE®

Screamin' Eagle® Performance Parts give your Harley® motorcycle race-quality performance at street-legal levels. From air cleaners, to engine and exhaust components, they turn heads and raise eyebrows without crossing the line.



## LIFE STAGES

If you're not quite sure where to start, the trained professionals at your local dealership stand ready to lend their experience to your velocity needs. They live this stuff, so all you have to do is ask. Just set some performance goals, and they'll hook you up with the corresponding, heart-pumping hardware. These parts will take you where you need to go – fast.

### BUILDING A PERFORMANCE BIKE



#### INTAKE & EXHAUST

Moving more air and fuel through the engine is the easiest (and most cost-effective) way to make more horsepower and torque. A free-flowing air cleaner and matching tuned exhaust will add performance you can feel. Heavy Breather and Stage I Free-Flow Air Cleaners are simple to install and bring a big performance boost for the dollars invested and sweet-sounding Street Performance mufflers deliver power you can feel across a broad RPM range.

#### STAGE KITS

Screamin' Eagle® EFI Stage Kits offer complete street-legal performance configurations engineered to help you generate specific torque and horsepower gains. Eliminating all the guesswork and trial-and-error testing normally associated with engine modifications, Stage Kits include everything you need to enhance your bike's performance, including big-bore cylinders, high-compression pistons, performance cams and high-flow air cleaners.

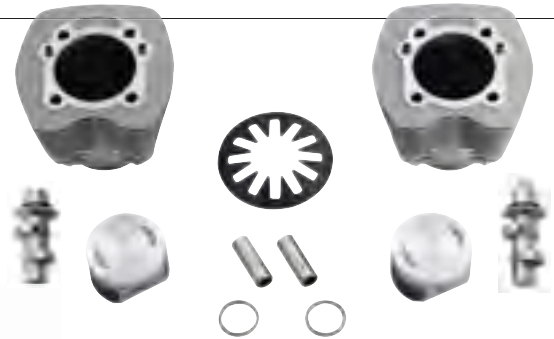

#### PERFORMANCE TUNING

Tuning an EFI-equipped motorcycle for performance is similar to modifying a carbureted model, in that freer-flowing intake and exhaust systems will require more fuel. The Screamin' Eagle Street Tuner provides computer-based tools that record and edit the bike's ECM tuning tables. To optimize drivability and performance, the Street Tuner permits limited tunability within the EPA/CARB-compliant emissions range and records and displays real-time vehicle data on screen.

### CAUTION ICONS



**GO LIGHT** These Screamin' Eagle products are 50-state street legal for sale and use on all vehicles, including those that are pollution-controlled. Complies with the requirements of 40 CFR Part 86, subparts E and F.



**STOP HAND** Harley-Davidson® motorcycles modified with some performance engine parts must not be used on public roads and in some cases may be restricted to closed-course competition. Those performance parts identified with a stop hand symbol are U.S. EPA legal, but are NOT legal for sale or use in California on pollution-controlled motor vehicles. California guidelines on tampering can also lead to substantial fines and penalties.



**CALIFORNIA** These Screamin' Eagle products are street legal for sale and use on pollution-controlled vehicles in the state of California.

### WARRANTY & CAUTION

#### OVERVIEW

Harley-Davidson has the engineering expertise, sophisticated dyno lab and complete testing facilities to provide enthusiasts with a line of performance products designed to produce good, solid, reliable horsepower and torque. Engine-related performance parts are intended for the experienced rider only.

#### WARRANTY

Installation of Screamin' Eagle products and similar off-road or competition products from other manufacturers, except some street-legal offerings installed by authorized Harley® dealers, may void your H-D® limited vehicle warranty. Installation of a California performance kit on a 49-state model motorcycle or a 49-state performance kit onto a California model motorcycle will void manufacturer's warranty, as it will not result in a street-legal configuration.

#### CAUTION

Harley-Davidson motorcycles modified with some Screamin' Eagle high-performance engine parts must not be used on public roads and in some cases may be restricted to closed-course competition.

# SCREAMIN' EAGLE® 479

Air Cleaner Kits



NEW

A. SCREAMIN' EAGLE HEAVY BREATHER ELITE PERFORMANCE AIR CLEANER KIT – CHROME

## A. SCREAMIN' EAGLE® HEAVY BREATHER ELITE PERFORMANCE AIR CLEANER KIT

Really open it up. This Heavy Breather Elite Air Cleaner features a forward-facing filter element that flows huge volumes of clean air. The low-profile cast elbow and the oval cross-section element combine to hug the engine to provide increased leg room. The intake tube mounts to a custom back plate that features integral breathers and covers the throttle body and electronics for a finished look. Available in your choice of chrome or gloss black finish, the Heavy Breather Elite kit features a washable and re-chargeable filter features bright chrome end caps and trim with Screamin' Eagle® script. Kit includes filter, intake tube, custom back plate, water-repellent rain sock and all mounting hardware. All EFI-equipped models require ECM calibration (priced separately).

Fits '14-later Touring models. Does not fit models equipped with Twin-Cooled™ engine, fairing lower glove boxes or fairing lower speakers. Street Legal when used with Original Equipment throttle body or with Screamin' Eagle® Street Performance Big Bore Stage 4 Kit P/N 92500011.

<b>29400173</b>	Chrome.	<b>\$399.95</b>
<b>29400172</b>	Gloss Black.	<b>\$399.95</b>

\*Recalibration is required for proper installations. See dealer for details. Labor costs not included.

NOTE: The washable and rechargeable filter uses a special coating to help filter fine particles from the incoming air. With time, the oil in the filter will dissipate and the element will begin to turn gray. The original red color can be restored with an application of K&N® Air Filter Oil.



NEW

A. SCREAMIN' EAGLE HEAVY BREATHER ELITE PERFORMANCE AIR CLEANER KIT – GLOSS BLACK



NEW

SCREAMIN' EAGLE HEAVY BREATHER ELITE PERFORMANCE AIR CLEANER KIT



NEW

SCREAMIN' EAGLE HEAVY BREATHER ELITE PERFORMANCE AIR CLEANER KIT (SHOWN WITH RAIN SOCK)

SCREAMIN' EAGLE

Notice: The prices appearing in this catalog are the manufacturer's suggested retail prices. Actual retail prices may vary.



# 480 SCREAMIN' EAGLE®

Air Cleaner Kits

## A. SCREAMIN' EAGLE® HEAVY BREATHER PERFORMANCE AIR CLEANER KIT

This high-flow forward-facing exposed element Air Cleaner Kit is sure to turn heads at the starting line. Featuring a polished elbow and exposed filter, this unique air cleaner system offers improved performance and airflow when compared to the stock or Screamin' Eagle® High-Flow Air Cleaner. The washable and rechargeable filter features a bright chrome end cap with a laser-engraved Screamin' Eagle logo. Intake tube and back plate are made from die-cast lightweight aluminum and are polished and chrome-plated or painted black for a brilliant finish. The back plate features integral breathers and sealed breather bolt plug. Kit includes a water-repellent rain sock and all mounting hardware. All EFI-equipped models require ECM calibration\* (priced separately).

Fits '08-later Touring, '11-'12 FLSTSE2/3 and '13-later FXSBSE and FLSTNSE models. Street legal when used with Original Equipment throttle body or with '10-later models when equipped with Screamin' Eagle Street Performance Big Bore Stage 4 Kit P/N 92500011. Does not fit models equipped with fairing lower glove boxes or fairing lower speakers. Does not fit Twin-Cooled™ models.

<b>29253-08B</b>	Chrome.	<b>\$329.95</b>
<b>29006-09B</b>	Gloss Black.	<b>\$329.95</b>

Fits '08-later Touring models equipped with Fairing Lower Glove Boxes (except Twin-Cooled models or models equipped with fairing lower speakers). Also fits '11-later CVO™ Softail® models. Street legal when used with Original Equipment throttle body or with Screamin' Eagle Street Performance Big Bore Stage 4 Kit P/N 92500011.

<b>28716-10A</b>	Compact Design – Chrome.	<b>\$329.95</b>
------------------	--------------------------	-----------------

Fits '08-later Dyna® and Softail models (except '11-'12 FLSTSE2/3, '13-later FXSBSE and '14-later FLSTNSE).\*

<b>29299-08</b>	Chrome.	<b>\$329.95</b>
<b>29098-09</b>	Gloss Black.	<b>\$329.95</b>

Fits '08-later XL models.\*

<b>29264-08</b>	Chrome.	<b>\$329.95</b>
<b>29080-09</b>	Gloss Black.	<b>\$329.95</b>

\*Recalibration is required for proper installation. See Dealer for details. Labor cost not included.

NOTE: The washable and rechargeable filter uses a special coating to help filter fine particles from the incoming air. With time, the oil in the filter will dissipate and the element will begin to turn gray. The original red color can be restored with an application of K&N® Air Filter Oil.

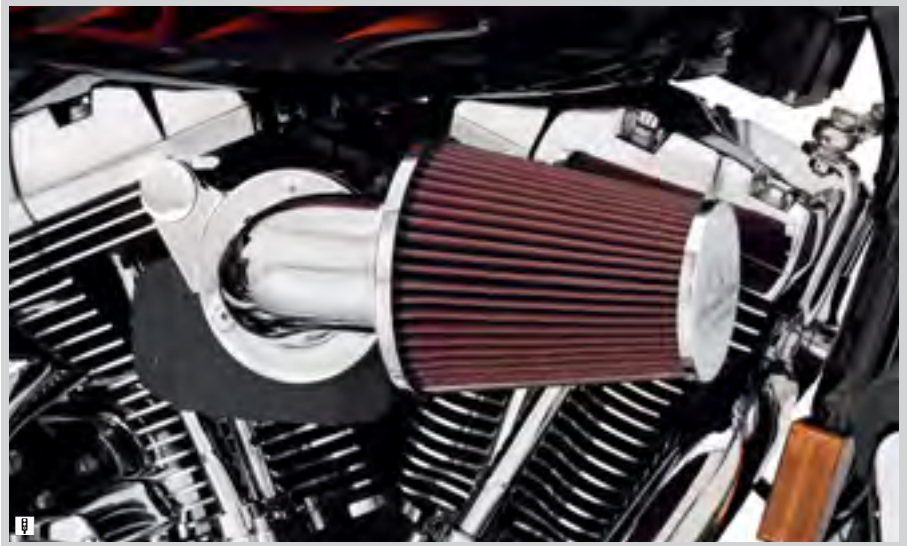

A. SCREAMIN' EAGLE HEAVY BREATHER PERFORMANCE AIR CLEANER KIT – CHROME



A. SCREAMIN' EAGLE HEAVY BREATHER PERFORMANCE AIR CLEANER KIT – GLOSS BLACK



A. SCREAMIN' EAGLE HEAVY BREATHER AIR CLEANER KIT – COMPACT



A. SCREAMIN' EAGLE HEAVY BREATHER PERFORMANCE AIR CLEANER KIT – GLOSS BLACK



A. SCREAMIN' EAGLE HEAVY BREATHER PERFORMANCE AIR CLEANER KIT – CHROME

Notice: The prices appearing in this catalog are the manufacturer's suggested retail prices. Actual retail prices may vary.

# SCREAMIN' EAGLE® 481

Air Cleaner Kits



**B. SCREAMIN' EAGLE HEAVY BREATHER FILTER COVER – TEARDROP, CUT BACK BLACK – SIDE LOGO**

**B. SCREAMIN' EAGLE® HEAVY BREATHER FILTER COVER – TEARDROP**

Dress up the Heavy Breather Air Cleaner with this radical cover. Manufactured from forged aluminum and precision CNC-machined and polished, these easy-to-install two-piece covers add a rich custom look. Cover is available in mirror-chrome or cut back black finish to match your customizing direction. Kit includes water-repellent rain sock.

Fits Heavy Breather Air Cleaner filter elements (except Compact Heavy Breather P/N 28716-10 or Heavy Breather Elite P/N 29400173 and 29400172). Does not fit with decorative filter end caps.

<b>29400061</b>	Cut Back Black – Side Logo.	<b>\$174.95</b>
<b>28739-10</b>	Cut Back Black – End Logo.	<b>\$169.95</b>
<b>28740-10</b>	Chrome – End Logo.	<b>\$174.95</b>



**B. SCREAMIN' EAGLE HEAVY BREATHER FILTER COVER – TEARDROP, CHROME**



**B. SCREAMIN' EAGLE HEAVY BREATHER FILTER COVER – TEARDROP, CUT BACK BLACK**

**C. SCREAMIN' EAGLE HEAVY BREATHER FILTER COVER – TWISTED SLOT**

Dress up the Heavy Breather Air Cleaner with this radical cover. Manufactured from forged aluminum and precision CNC-machined and polished, these easy-to-install two-piece covers add a rich custom look. Cover is available in mirror-chrome or cut back black finish to match your customizing direction. Kit includes water-repellent rain sock.

Fits Heavy Breather Air Cleaner filter elements (except Compact Heavy Breather P/N 28716-10 or Heavy Breather Elite P/N 29400173 and 29400172). Does not fit with decorative filter end caps.

<b>28742-10</b>	Chrome.	<b>\$174.95</b>
<b>28741-10</b>	Cut Back Black.	<b>\$174.95</b>

**D. SCREAMIN' EAGLE HEAVY BREATHER DECORATIVE ENDCAP – WILLIE G SKULL**

Add a sinister touch to your Heavy Breather Air Cleaner. Chrome-plated self-adhesive cover features a forward-facing Willie G Skull medallion.

**28720-10** **\$34.95**  
Fits models equipped with Screamin' Eagle® Heavy Breather Air Cleaner Kits (except Compact Heavy Breather P/N 28716-10 or Heavy Breather Elite P/N 29400173 and 29400172).



**C. SCREAMIN' EAGLE HEAVY BREATHER FILTER COVER – TWISTED SLOT, CHROME**



**C. SCREAMIN' EAGLE HEAVY BREATHER FILTER COVER – TWISTED SLOT, CUT BACK BLACK**

**E. SCREAMIN' EAGLE HEAVY BREATHER DECORATIVE MEDALLION**

Add the finishing touch to your Heavy Breather Air Cleaner by installing this medallion. Featuring a bright chrome-plated die-cast base and contrasting black inlay with diamond cut "Screamin' Eagle" script. Easy to install.

**29017-09** **\$21.95**  
Fits models equipped with Heavy Breather Air Cleaner Kits (except Compact Heavy Breather P/N 28716-10 or Heavy Breather Elite P/N 29400173 and 29400172).



**D. SCREAMIN' EAGLE HEAVY BREATHER DECORATIVE ENDCAP – WILLIE G SKULL**



**E. SCREAMIN' EAGLE HEAVY BREATHER DECORATIVE MEDALLION**

*Notice: The prices appearing in this catalog are the manufacturer's suggested retail prices. Actual retail prices may vary.*



# 482 SCREAMIN' EAGLE®

Air Cleaner Kits

## A. SCREAMIN' EAGLE® EXTREME BILLET AIR CLEANER KIT

The bold styling of this intake system looks just as impressive as the long patch of burnout rubber you just laid down. The forged billet aluminum cover tops off a cast back plate with integral breather for a smooth transition to the throttle body. The race-inspired air cleaner is engineered to flow high volumes of air and the washable pleated element provides the ideal combination of efficiency and engine protection. Available in your choice of style and finish, this easy-to-install kit includes all mounting hardware and rain sock. All EFI-equipped models require ECM calibration\* (priced separately).

Fits '08-later Touring and Trike models with Original Equipment 50mm Throttle Body.

<b>29400064</b>	Agitator – Chrome.	<b>\$349.95</b>
<b>29400063</b>	Agitator – Cut Back Black.	<b>\$349.95</b>
<b>29400104</b>	Chisel – Chrome.	<b>\$349.95</b>
<b>29400103</b>	Chisel – Cut Back Black.	<b>\$349.95</b>

Fits '08-later Dyna® and Softail® models (except '11-later CVO™ Softail).

<b>29400116</b>	Chisel – Cut Back Black.	<b>\$349.95</b>
<b>29400117</b>	Chisel – Chrome.	<b>\$349.95</b>

Fits '07-later XL models with Original Equipment throttle body.

<b>29400127</b>	Chisel – Cut Back Black.	<b>\$349.95</b>
<b>29400128</b>	Chisel – Chrome.	<b>\$349.95</b>

\*Recalibration is required for proper installation. See Dealer for details. Labor cost not included.



A. EXTREME BILLET AIR CLEANER KIT – AGITATOR, CHROME



A. EXTREME BILLET AIR CLEANER KIT – AGITATOR, CUT BACK BLACK



A. EXTREME BILLET AIR CLEANER KIT – CHISEL, CHROME



A. EXTREME BILLET AIR CLEANER KIT – CHISEL, CUT BACK BLACK



A. EXTREME BILLET AIR CLEANER KIT



A. EXTREME BILLET AIR CLEANER KIT (SHOWN WITH RAIN SOCK)

Notice: The prices appearing in this catalog are the manufacturer's suggested retail prices. Actual retail prices may vary.



NEW

# SCREAMIN' EAGLE® 483

Air Cleaner Kits

## B. SCREAMIN' EAGLE® PERFORMANCE AIR CLEANER KIT – THE BURST COLLECTION

Performance and style combined. Designed to complement the Burst Collection, this radical low profile air cleaner features a "tuxedo black" surround that has been expertly machined to expose the satin aluminum finish below. The billet cover conceals a one-piece cast back plate with integral breather and mounting bracket that promotes smooth air flow into the throttle body. The exposed reverse cone cotton element provides high-volumes of air and the element is washable for maximum efficiency and protection. The complete kit includes Burst Collection trim, backing plate, air cleaner element and all required installation hardware. All EFI-equipped models require ECM calibration\* (priced separately).

**29000066** **\$374.95**

Fits '08-later Touring and Trike models with Original Equipment 50mm throttle body or with Screamin' Eagle® Street Performance Big Bore Stage 4 Kit P/N 92500011 or 92500020.

**29400178** **\$374.95**

Fits '08-later Dyna® and Softail® models (except '11-'12 FLSTSE2/3, '13-'14 FXSBSE and '14-'15 FLSTNSE).

\*Recalibration is required for proper installation. See Dealer for details. Labor cost not included.

B. SCREAMIN' EAGLE PERFORMANCE AIR CLEANER KIT – THE BURST COLLECTION



NEW



NEW

B. SCREAMIN' EAGLE PERFORMANCE AIR CLEANER KIT – THE BURST COLLECTION

SCREAMIN' EAGLE

*Notice: The prices appearing in this catalog are the manufacturer's suggested retail prices. Actual retail prices may vary.*



# 484 SCREAMIN' EAGLE®

Air Cleaner Kits

## A. SCREAMIN' EAGLE® EXTREME BILLET VENTILATOR AIR CLEANER KIT

The proven, track-inspired exposed element Ventilator air cleaner with a completely totally unique look. This low-profile oval air cleaner features a 360° exposed filter element for maximum air flow and a stylish machined billet aluminum cover for style. Available in your choice of chrome or cut back black finish, the two-piece billet cover surrounds the filter and features a full color Screamin' Eagle® medallion. The cast back plate ensures smooth air flow to the throttle body and the included rain sock protects the filter and engine from drawing in moisture during inclement weather. This easy-to-install kit includes billet air cleaner cover, high-flow filter element, back plate, protective rain sock and all required installation hardware. Street legal when used with stock mufflers. All EFI-equipped models require ECM calibration\* (priced separately).

Fits '09-later Touring and Trike models. Also fits '11-later FLSTSE2/3, FLSTNSE and FXSBSE models.

<b>29400163</b>	Chrome.	<b>\$449.95</b>
<b>29400164</b>	Cut Back Black.	<b>\$449.95</b>

Fits '10-later Dyna® and Softail® models (except '11-later CVO™ Softail models).

<b>29400167</b>	Chrome.	<b>\$449.95</b>
<b>29400168</b>	Cut Back Black.	<b>\$449.95</b>

\*Recalibration is required for proper installation. See Dealer for details. Labor cost not included.



A. SCREAMIN' EAGLE EXTREME BILLET VENTILATOR AIR CLEANER KIT – CHROME



A. SCREAMIN' EAGLE EXTREME BILLET VENTILATOR AIR CLEANER KIT – CUT BACK BLACK



A. SCREAMIN' EAGLE EXTREME BILLET VENTILATOR AIR CLEANER KIT – CHROME



A. EXTREME BILLET VENTILATOR AIR CLEANER KIT (SHOWN WITH RAIN SOCK)

Notice: The prices appearing in this catalog are the manufacturer's suggested retail prices. Actual retail prices may vary.

# SCREAMIN' EAGLE® 485

Air Cleaner Kits



**NEW**

**B. SCREAMIN' EAGLE VENTILATOR ELITE AIR CLEANER KIT – CHROME**

## B. SCREAMIN' EAGLE® VENTILATOR ELITE AIR CLEANER KIT

This low-profile oval air cleaner features a 360° exposed filter element and a cast back plate designed to provide maximum air flow to the throttle body. This easy-to-install air cleaner produces significant performance gains, while the sleek center bar design cover with carbon fiber inserts add a luxurious touch. This complete kit includes low-profile air cleaner cover, high-flow filter element, back plate, diamond-cut Screamin' Eagle® medallion, protective rain sock and all required installation hardware. Street legal when used with stock mufflers. All EFI-equipped models require ECM calibration\* (priced separately).

Fits '09-later Touring and Trike models. Also fits '11-later FLSTSE2/3, FLSTNSE and FXSBSE models.

<b>29400217</b>	Chrome.	<b>\$299.95</b>
<b>29400218</b>	Gloss Black.	<b>\$299.95</b>

**Also available:**

## SCREAMIN' EAGLE VENTILATOR ELITE AIR CLEANER COVER

Add a luxurious finishing touch to your Ventilator Air Cleaner. Designed as a direct replacement for the Screamin' Eagle and CVO™ Ventilator Air Cleaners, this easy to install cover features a sleek center bar design surrounded with carbon fiber inserts. Kit includes low-profile cover, diamond-cut Screamin' Eagle medallion and chrome mounting hardware.

Fits Dyna®, Softail®, Touring and Trike models equipped with Screamin' Eagle Ventilator Air Cleaner Kits P/N 29490-09, 29915-09, 28721-10, 28722-10 or 29400039. Also fits CVO models with Original Equipment Ventilator Air Cleaner.

<b>61300516</b>	Chrome.	<b>\$109.95</b>
<b>61300517</b>	Gloss Black.	<b>\$109.95</b>



**NEW**

**B. SCREAMIN' EAGLE VENTILATOR ELITE AIR CLEANER KIT – BLACK**



**NEW**

**B. SCREAMIN' EAGLE VENTILATOR ELITE AIR CLEANER KIT**



**NEW**

**B. VENTILATOR ELITE AIR CLEANER KIT (SHOWN WITH RAIN SOCK)**

*Notice: The prices appearing in this catalog are the manufacturer's suggested retail prices. Actual retail prices may vary.*

SCREAMIN' EAGLE



# 486 SCREAMIN' EAGLE®

Air Cleaner Kits

## A. SCREAMIN' EAGLE® VENTILATOR PERFORMANCE AIR CLEANER KIT

Stylish low-profile exposed element air cleaner kit provides increased airflow to boost the power of your fuel-injected engine. The track-inspired exposed element adds a purposeful look to the bike and the included waterproof rain sock protects the filter during inclement weather. This easy-to-install kit includes low-profile air cleaner cover, high-flow filter element, back plate, Screamin' Eagle® badge, protective rain sock and all required installation hardware. Street legal when used with stock mufflers. All EFI-equipped models require ECM calibration\* (priced separately).

Fits '09-later Touring and Trike models. Also fits '11-later CVO™ Softail® models.

<b>29490-09</b>	Chrome.	<b>\$249.95</b>
<b>29915-09</b>	Gloss Black.	<b>\$249.95</b>

Fits '10-later Dyna® and Softail models (except '11-later CVO Softail models).

<b>28721-10</b>	Chrome.	<b>\$249.95</b>
<b>28722-10</b>	Gloss Black.	<b>\$249.95</b>

\*Recalibration is required for proper installation. See Dealer for details. Labor cost is not included.



A. SCREAMIN' EAGLE VENTILATOR PERFORMANCE AIR CLEANER KIT – CHROME



A. SCREAMIN' EAGLE VENTILATOR PERFORMANCE AIR CLEANER KIT – GLOSS BLACK



A. SCREAMIN' EAGLE VENTILATOR PERFORMANCE AIR CLEANER KIT (SHOWN WITH RAIN SOCK)



A. SCREAMIN' EAGLE VENTILATOR PERFORMANCE AIR CLEANER KIT

Notice: The prices appearing in this catalog are the manufacturer's suggested retail prices. Actual retail prices may vary.

# SCREAMIN' EAGLE® 487

Air Cleaner Kits



**B. SCREAMIN' EAGLE PERFORMANCE AIR CLEANER FOR VRSC MODELS**

**B. SCREAMIN' EAGLE® PERFORMANCE AIR CLEANER FOR VRSC™ MODELS**

This high-flow air cleaner provides the clean stable air the engine needs for maximum performance. The washable filter element does not require oiling.

**29793-02C** Fits '02-later VRSC™ models. **\$64.95**

**C. SCREAMIN' EAGLE SPORTSTER® STAGE I AIR CLEANER KIT – OVAL\***

The XL Stage I Air Cleaner Kit provides increased airflow to boost the power of your fuel-injected Sportster® model. The complete kit features a composite air cleaner back plate, air cleaner cover adapter, a high-flow washable synthetic media filter element that does not require oiling and a breather system that routes gasses and excess oil directly into the intake. Kit also includes cover trim and all mounting hardware. Street legal when used with stock mufflers. All models require ECM calibration\* (priced separately).

**29782-07** **\$144.95**

Fits '07-later XL models with stock oval air cleaner cover. XL1200V requires separate purchase of oval air cleaner cover P/N 29084-04DH.

\*Recalibration is required for proper installation. See Dealer for details.

**D. SCREAMIN' EAGLE SPORTSTER STAGE I AIR CLEANER KIT – ROUND\***

The XL Stage I Air Cleaner Kit provides increased airflow to boost the power of your fuel-injected Sportster model. Available with brilliant chrome or gloss black back plate, this Round Air Cleaner transforms the appearance of your Evolution power plant and allows you to replace the Original Equipment oval air cleaner cover with your choice of accessory round covers. Or choose to flaunt your performance gains with the open element look, finished with custom Air Cleaner Trim from one of the Harley-Davidson® decorative collections. Kit includes one-piece cast back plate, high-flow washable air filter element and all required hardware. Street legal when used with stock mufflers. Requires ECM calibration\* (priced separately).

Fits '07-later XL models. Requires separate purchase of a round air cleaner cover or Twin Cam-style air cleaner trim. Air Cleaners P/N 29400-08, 29153-07, 29417-04, 61400007, 61400009, 61300057 and 27956-10 require separate purchase of Screw P/N 29269-83A. XL1200V requires separate purchase of Gasket P/N 25700127.

**29000009A** Black. **\$149.95**

**29000019A** Chrome. **\$149.95**

\*Recalibration is required for proper installation. See Dealer for details.



**C. SCREAMIN' EAGLE SPORTSTER STAGE I AIR CLEANER KIT – OVAL**



**D. SCREAMIN' EAGLE SPORTSTER STAGE I AIR CLEANER KIT – ROUND**



**SPORTSTER 1200 STOCK VS. STAGE I AIR CLEANER & STREET CANNON MUFFLERS**

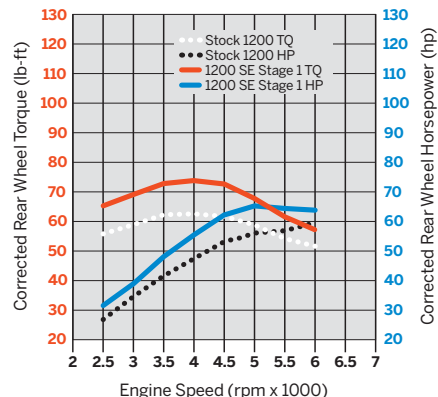

Notice: The prices appearing in this catalog are the manufacturer's suggested retail prices. Actual retail prices may vary.

SCREAMIN' EAGLE



# 488 SCREAMIN' EAGLE®

Air Cleaner Kits

## A. SCREAMIN' EAGLE® STAGE I AIR CLEANER KIT – TWIN CAM MODELS\*

Kit features a one-piece cast back plate with integral breather and mounting brackets for simplified installation and a "state of the art" synthetic media washable air cleaner element that does not require oiling. If you want more torque from your Twin Cam-equipped model, this kit provides a freer breathing capability to pump-up the power of your EFI-equipped motorcycle. This kit includes air cleaner, breather and all required hardware. Street legal when used with stock mufflers. All EFI-equipped models require ECM calibration\* (priced separately).

### 29773-02C \$144.95

Fits '08-later Softail® and Dyna® equipped with accessory Air Cleaner Covers (stock on '08 CVO™ Dyna). FXS, FLS, FLSTSB and '13 FXDB models require separate purchase of Gasket P/N 29591-99 and Screw P/N 29703-00. Also fits '01-'07 EFI Softail, '02-'07 EFI Touring, '04-'07 EFI Dyna and models equipped with Accessory Air Cleaner Covers. (Stock on '05 FLSTFI 15th Anniversary, '05-'07 CVO Softail, '07 CVO Dyna and '07 CVO Road King® models.) '06-'07 CVO Electra Glide® models require the separate purchase of Air Cleaner Cover P/N 29121-07. Air Cleaner Trim is sold separately.

### 29400129 \$149.95

Fits '14-later Touring and Trike models with Original Equipment 50mm Throttle Body.

### 29260-08 \$144.95

Fits '08-13 Touring and Trike models with Original Equipment 50mm Throttle Body. '08-later CVO models require separate purchase of Air Cleaner Cover P/N 29121-07.

### 29406-08 \$149.95

Fits '08-later Dyna models with Original Equipment Teardrop Air Cleaner Cover.

### 29489-99C \$174.95

Fits '99-'01 fuel-injected Touring models.

\*Recalibration is required for proper installation. See Dealer for details. Labor cost not included.



A. SCREAMIN' EAGLE STAGE I AIR CLEANER KIT

### TWIN CAM 103 HO STOCK VS. 103 HO STAGE 1

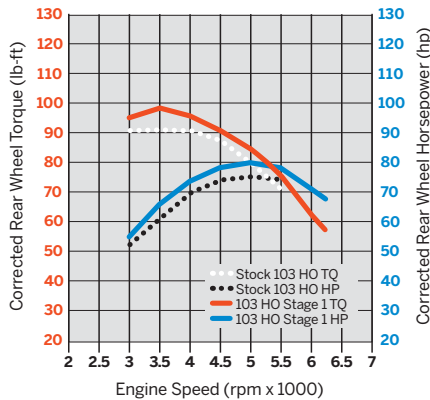

A. SCREAMIN' EAGLE STAGE I AIR CLEANER KIT – MULTI-FIT (29773-02C SHOWN)



A. SCREAMIN' EAGLE STAGE I AIR CLEANER KIT (29400129 SHOWN)



A. SCREAMIN' EAGLE STAGE I AIR CLEANER KIT (29260-08 SHOWN)



A. SCREAMIN' EAGLE STAGE I AIR CLEANER KIT – '08-LATER DYNA (29406-08 SHOWN)

Notice: The prices appearing in this catalog are the manufacturer's suggested retail prices. Actual retail prices may vary.

# SCREAMIN' EAGLE® 489

Air Cleaner Kits



**B. SCREAMIN' EAGLE AIR CLEANER INSERT**



**C. SCREAMIN' EAGLE AIR CLEANER TRIM RING**

## B. SCREAMIN' EAGLE® AIR CLEANER INSERT

Dress your factory air cleaner cover with a diamond cut Screamin' Eagle® medallion. Lock patch holds the medallion firmly in place and is easy to remove for access to the air cleaner hardware.

**61300299** **\$19.95**  
Fits '14-later Touring and Trike models (except CVO™) equipped with Original Equipment air cleaner cover.

## C. SCREAMIN' EAGLE AIR CLEANER TRIM RING

Dress your air cleaner in the traditional H-D® orange and black. Easy-to-install trim ring features brilliant orange Screamin' Eagle script and Harley-Davidson lettering set against a gloss black background. Self adhesive backing.

**29503-07** **\$14.95**  
Fits '07-'13 Touring and Trike, '07-later Softail® (except FXS and FLSTSB) and '07 Dyna® models equipped with Original Equipment air cleaner cover.

## D. SCREAMIN' EAGLE ACCESSORY COLLECTION

Add style to your motorcycle with these Screamin' Eagle accessories and proclaim you're serious about performance.

### 1. Oval Air Cleaner Insert

Fits '66-'03 XL models.

**29382-97A** Black on Silver. **\$14.95**

**29383-97A** Silver on Black. **\$14.95**

### 2. Air Cleaner Insert

Fits '84-'99 Evolution® 1340-equipped models.

**29619-99** Silver on Black. **\$14.95**

### 3. Air Cleaner Insert

Fits '99-'06 Twin Cam-equipped models.

**29620-99** Black on Silver. **\$14.95**

**29567-99** Silver on Black. **\$14.95**



**D. SCREAMIN' EAGLE ACCESSORY COLLECTION**



**E. SCREAMIN' EAGLE AIR CLEANER RAIN SOCK (SHOWN WITH #1 SKULL AIR CLEANER TRIM)**

## E. SCREAMIN' EAGLE AIR CLEANER RAIN SOCK

Add the open-element look to your Screamin' Eagle Stage-style Air Cleaner. This easy-to-install kit allows you to replace the traditional Original Equipment air cleaner cover with custom inserts from one of the H-D Decorative Collections. Kit includes a breathable mesh cover with classic Bar & Shield logo that stretches over the filter to maximize airflow while protecting the exposed element from the rain. Fits traditional cone-shaped air cleaner elements featured in many Screamin' Eagle Twin Cam Stage Kits.

**28728-10** **\$25.95**

Fits Screamin' Eagle Air Cleaner Kits P/N 29773-02C, 29260-08, 29000009 and 29000019A.

## F. SCREAMIN' EAGLE AIR CLEANER

### BACK PLATE KITS

Finished in brilliant chrome or wrinkle black, these replacement back plates complement the finish of your engine. Cast back plate design features integral breather and mounting brackets for simplified installation.

Fits models equipped with Screamin' Eagle Stage Kits or High-Flow Air Cleaner Kits. Installation may require separate purchase of (2) O-Ring P/N 11292, (2) Breather Tube P/N 29557-05 and (2) Breather Screw P/N 29465-99. See your Dealer for details.

Fits '99-later Softail (except '11-later CVO) '02-'07 Touring and '99-'07 Dyna models.

**29510-05** Chrome. **\$59.95**

**29586-06** Wrinkle Black. **\$49.95**

Fits '08-'13 Touring and Trike models.

**29624-08** Chrome. **\$59.95**

**29319-08** Wrinkle Black. **\$49.95**

Fits '08-later Dyna models with Original Equipment Teardrop Air Cleaner Cover.

**29170-08** Chrome. **\$59.95**

**29119-08** Wrinkle Black. **\$49.95**



**F. SCREAMIN' EAGLE AIR CLEANER BACK PLATE KITS**

Notice: The prices appearing in this catalog are the manufacturer's suggested retail prices. Actual retail prices may vary.

SCREAMIN' EAGLE



# 490 SCREAMIN' EAGLE®

Air Cleaner Kits

## A. FORGED BILLET ALUMINUM AIR CLEANER COVER

This unique Billet Aluminum Air Cleaner Cover is styled with inverted V-shape air inlets to complement the V-Twin engine profile and is designed with a generous open intake to maximize engine breathing. Manufactured from 6061-T6 billet aluminum, this high-quality forged dual throat air cleaner cover is expertly CNC-machined to exacting tolerances. Then, its surfaces are polished mirror-smooth and chrome-plated or black anodized to match your customizing direction. The air cleaner kits include complementing brushed aluminum or matte black side inserts and a hidden mounting bolt. Complete the installation with one of the numerous custom medallion inserts (sold separately).

Fits '99-later Twin Cam, '07-later XL and '93-'99 Evolution® 1340 carbureted models equipped with Screamin' Eagle® Round Filter Air Cleaner Kits (round cone-shaped filter). See your dealer for specific applications.

<b>29506-09</b>	Black.	<b>\$229.95</b>
<b>29745-00A</b>	Chrome.	<b>\$229.95</b>

Also available:

### BILLET AIR CLEANER SIDE INSERT KIT

Add a touch of color to the H-D® Forged Billet Aluminum Air Cleaner Cover. These easy-to-install Side Inserts are available in a matte black finish to add depth and dimension.

<b>97005-02</b>		<b>\$9.95</b>
Fits Chrome Forged Billet Aluminum Air Cleaner Cover P/N 29745-00A.		

Also shown with:

### BILLET AIR CLEANER MEDALLION KITS

These polished and chrome-plated inserts for the Billet Air Cleaner Cover snap easily into place. The kit includes an O-ring gasket and individual decorative medallions.

Fits Forged Billet Aluminum Air Cleaner Covers P/N 29745-00A and 29506-09.

<b>29902-09</b>	Dark Custom™ Collection.	<b>\$42.95</b>
<b>29833-06</b>	Willie G Skull Collection.	<b>\$42.95</b>
<b>29929-07</b>	Screamin' Eagle 96 Cubic Inch.	<b>\$42.95</b>
<b>29888-06</b>	Screamin' Eagle 103 Cubic Inch.	<b>\$42.95</b>
<b>29898-06</b>	Screamin' Eagle 110 Cubic Inch.	<b>\$42.95</b>

## B. THROTTLE BODY COVER

This cover dresses the area between the Twin Cam cylinders for a custom look. The formed cover hugs the contour and conceals the electronic control module throttle body for a clean appearance. Available in your choice of mirror-chrome or gloss black finish. Easy-to-install kit includes gaskets.

Fits '11-later CVO™ Softail® and '08-later Touring and Trike models equipped with Screamin' Eagle Heavy Breather or Burst Air Cleaner Kit.

<b>61300109</b>	Chrome.	<b>\$59.95</b>
<b>61300110</b>	Gloss Black.	<b>\$59.95</b>



**A. BILLET AIR CLEANER COVER – BLACK (SHOWN WITH DARK CUSTOM MEDALLION)**



**A. BILLET AIR CLEANER COVER – CHROME (SHOWN WITH WILLIE G SKULL MEDALLION)**



**A. BILLET AIR CLEANER MEDALLION KITS**



**B. THROTTLE BODY COVER – CHROME**



**B. THROTTLE BODY COVER – GLOSS BLACK**

*Notice: The prices appearing in this catalog are the manufacturer's suggested retail prices. Actual retail prices may vary.*

# SCREAMIN' EAGLE® 491

Air Cleaner Kits

## C. SCREAMIN' EAGLE® HIGH-FLO K&N® AIR FILTER ELEMENT

K&N® replacement air filters are engineered to improve airflow for increased horsepower and quicker acceleration. K&N filters provide excellent filtration and because they are washable and reusable, you can clean the filter whenever conditions demand. Designed as direct replacements for specified fitments.

NOTE: These washable and rechargeable filters use a special coating to help filter fine particles from the incoming air. With time, the oil in the filter will dissipate and the element will begin to turn gray. Clean the surface and renew the original red color with an application of K&N Air Filter Care products.

**1. 29400020** Stage I–Multi-fit. **\$59.95**  
Fits '07-later XL, '99-'07 Dyna®, '00-later Softail® and '99-'07 Touring models equipped with Stage I Air Cleaner Kit P/N 29000009, 29000019A, 29773-02C or 29440-99D. Replacement for P/N 29442-99E.

**2. 29400021** Stage I–Dyna. **\$59.95**  
Fits '08-later Dyna models equipped with Stage I Air Cleaner Kit P/N 29406-08. Replacement for P/N 29385-08.

**3. 29400019** Stage I–Touring. **\$59.95**  
Fits '08-later Touring and Trike models equipped with Stage I Air Cleaner Kit P/N 29260-08. Replacement for P/N 29244-08.

**4. 29400065** Extreme Billet. **\$59.95**  
Fits '15-later XG and '08-later Touring and Trike models equipped with Extreme Billet Agitator and Chisel Air Cleaner Kits.

**4. 29400118** Extreme Billet. **\$59.95**  
Fits '07-later XL, '08-later Dyna and '08-later Softail models equipped with Extreme Billet Chisel Air Cleaner Kits.

**5. 29400109** Burst Collection. **\$59.95**  
Fits models equipped with Burst Collection Air Cleaner Kits.

**6. 29400026** Stage I–XL. **\$59.95**  
Fits '88-later XL models equipped with High-Flow Air Cleaner Kit P/N 29042-04C or 29066-03B. Replacement for P/N 29044-04B.

**7. 29400022A** Ventilator–Multi-fit. **\$59.95**  
Fits models equipped with Ventilator and Extreme Billet Ventilator Performance Air Cleaner Kits. Replacement for P/N 29670-09.

**8. 29424-05A** Heavy Breather–Multi-fit. **\$89.95**  
Fits '91-later XL, '99-later Dyna, '00-later Softail and '99-'07 Touring models equipped with Heavy Breather Kit P/N 29098-09, 29299-08, 29080-09 or 29264-08.

**8. 29702-08A** Heavy Breather–Touring. **\$89.95**  
Fits models equipped with Heavy Breather Kit P/N 29006-09B, 29253-08B, 29000065 or 29400105.

**9. 28714-10** Heavy Breather–Compact Touring. **\$89.95**  
Fits '08-later Touring and Trike models equipped with Compact Heavy Breather Kit P/N 28716-10A.

**10. 29400141** Heavy Breather–Elite. **\$99.95**  
Fits models equipped with Screamin' Eagle® Heavy Breather Elite Performance Air Cleaner Kit P/N 29400172 and 29400173.

## D. K&N AIR FILTER CARE PRODUCTS

Clean and restore the original performance of K&N air filter elements. The washable and rechargeable filters use a special coating to help filter fine particles from the incoming air. With time, the oil in the filter will dissipate and the element will begin to turn gray. Clean the surface and renew the original red color with an application of K&N Air Filter Care products.

### K&N AIR FILTER CARE SERVICE KIT

**99850-92T** **\$14.95**  
Complete kit to clean and re-oil K&N-type air filters. Includes one 12 oz bottle Air Filter Cleaner and one aerosol Air Filter Oil.

### K&N AIR FILTER OIL

**99882-88T** 12 oz Aerosol. **\$9.95**

### K&N POWER KLEEN AIR FILTER CLEANER

**93600004** 32 oz with Sprayer. **\$11.95**



C. SCREAMIN' EAGLE HIGH-FLO K&N AIR FILTER ELEMENT



D. K&N AIR FILTER CARE SERVICE KIT



D. K&N AIR FILTER OIL

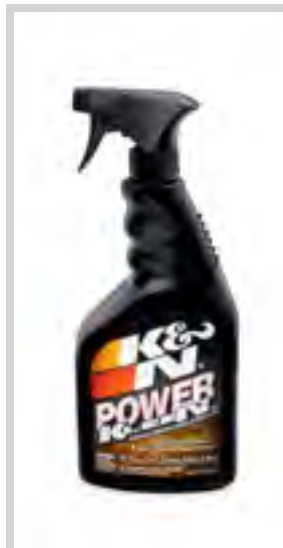

D. K&N POWER KLEEN AIR FILTER CLEANER

Notice: The prices appearing in this catalog are the manufacturer's suggested retail prices. Actual retail prices may vary.

SCREAMIN' EAGLE



### MORE THAN JUST HOT AIR

The sound of a Harley-Davidson® motorcycle grabs the heart and moves the soul. The complete line of Screamin' Eagle® Street Performance Mufflers is tuned to enhance the bass notes and deliver a rich melodic tone from idle to wide-open throttle. These stylish slip-on mufflers produce real-world performance improvements, while maintaining EPA-approved sound levels.



### POWER VS. NOISE

A loud exhaust system doesn't mean improved performance. Screamin' Eagle® Street Performance Mufflers are designed to significantly increase airflow and add torque and horsepower you can feel with a twist of the throttle. Engineered to deliver where it counts — during a roll-on pass or on a long run up a steep grade — all street-legal Harley-Davidson® exhaust systems carry the EPA stamp.

**The "Room"** — a silent chamber lined with perforated sheet metal and 50,000 pounds of fiberglass acoustic wedges — uses a wide array of microphones to get precise readings of drive-by noise. This is the room that creates that world-famous Harley-Davidson sound.





**A. SCREAMIN' EAGLE STREET CANNON SLIP-ON MUFFLERS –  
SPORTSTER SHORTY DUAL – CHROME**



**A. SCREAMIN' EAGLE STREET CANNON SLIP-ON MUFFLERS –  
SPORTSTER SHORTY DUAL – JET BLACK**



**B. SCREAMIN' EAGLE END CAPS –  
CHROME SLASH CUT**



**B. SCREAMIN' EAGLE END CAPS –  
JET BLACK WITH SE SCRIPT**

# SCREAMIN' EAGLE® 493

Sportster® Exhaust

## A. SCREAMIN' EAGLE® STREET CANNON SLIP-ON MUFFLERS – SPORTSTER SHORTY DUAL

These 3.25" street legal high-flow mufflers have been specifically tuned to deliver an aggressive exhaust note and improved performance while preserving the peace with your neighbors. Available in your choice of rich chrome or heat resistant jet black ceramic finish. The Jet Black mufflers include Screamin' Eagle® muffler shields. EPA stamped. Complete the look with your choice of 3.25" endcaps (sold separately).

Fits '14-later XL models. Installation requires separate purchase of End Caps and Muffler Clamps P/N 65296-95A (Qty 2).

<b>64900208</b>	Chrome.	<b>\$419.95</b>
<b>64900209</b>	Jet Black w/ muffler shields.	<b>\$459.95</b>

## B. SCREAMIN' EAGLE END CAPS – 3.25"

These easy-to-install caps allow you to finish your 3.25" Screamin' Eagle mufflers your way. Sold in pairs. Installation hardware included.

Fits Screamin' Eagle 3.25" Street Cannon Mufflers P/N 64900208 and 64900209.

<b>65100049</b>	Chrome Slash Cut.	<b>\$119.95</b>
<b>65100048</b>	Jet Black with SE Script.	<b>\$119.95</b>



# 494 SCREAMIN' EAGLE®

Sportster® Exhaust

## A. SCREAMIN' EAGLE® STREET PERFORMANCE SLIP-ON MUFFLERS – SPORTSTER® SHORTY DUAL

Street legal high-flow mufflers are factory tuned to deliver an aggressive exhaust note and improved performance comparable to Screamin' Eagle® II mufflers. Available in your choice of rich chrome or heat-resistant jet black ceramic finish, these mufflers feature a deep embossed Screamin' Eagle logo along the flank. EPA stamped, these mufflers are 50-state street legal on stock '07-later model engines.

Fits '07-'13 XL models. Installation requires separate purchase of Muffler Clamps P/N 65296-95A (Qty 2).

<b>80503-07</b>	Chrome.	<b>\$299.95</b>
<b>80726-09A</b>	Jet Black.	<b>\$399.95</b>



A. SCREAMIN' EAGLE STREET PERFORMANCE SLIP-ON SHORTY DUAL MUFFLERS – CHROME

## B. HARLEY-DAVIDSON® SLIP-ON MUFFLERS – SPORTSTER SHORTY DUAL

These brilliant chrome-finished mufflers feature a classic slash down or tapered baloney cut design that adds a custom touch to any XL. The 49-state street legal mufflers offer great sound quality and feature the "Harley-Davidson" script on the rear muffler. Not legal for sale or use on California catalyst-equipped vehicles.

Fits '06 XL models.

<b>80417-06</b>	Tapered Baloney Cut.	<b>\$319.95</b>
<b>80416-06</b>	Slash Down.	<b>\$319.95</b>

Fits '04-'05 XL models.

<b>80415-04</b>	Slash Down.	<b>\$319.95</b>
<b>80412-04</b>	Tapered Baloney Cut.	<b>\$319.95</b>

Fits '98-'03 XL (except 883R), '92-'03 883 Hugger™, '96-'03 XL1200C and '92-'03 XL models equipped with Profile® Low Rear Suspension P/N 54571-94A.

<b>80102-97</b>	Baloney Cut.	<b>\$319.95</b>
-----------------	--------------	-----------------



A. SCREAMIN' EAGLE STREET PERFORMANCE SLIP-ON SHORTY DUAL MUFFLERS – JET BLACK (SHOWN WITH JET BLACK BUCKSHOT EXHAUST SHIELDS)



B. HARLEY-DAVIDSON SLIP-ON MUFFLERS – SLASH DOWN



B. HARLEY-DAVIDSON SLIP-ON MUFFLERS – TAPERED BALONEY CUT

NOTE: Due to increased diameter of these mufflers some realignment of head pipes is usually required. It is recommended to replace exhaust port gaskets, P/N 65324-83A (stock) or P/N 17048-98 (performance), to avoid tendency of head pipes to return to original position when re-tightened.

NOTE: There is no warranty on exhaust pipes and mufflers with regard to any discoloration. Blueing is caused by tuning characteristics, cam timing, carburetor jetting, over-heating, etc. and is not caused by defective manufacturing.

Notice: The prices appearing in this catalog are the manufacturer's suggested retail prices. Actual retail prices may vary.



**C. SCREAMIN' EAGLE JET BLACK HEADER PIPES (65600155 SHOWN)**



**C. SCREAMIN' EAGLE JET BLACK HEADER PIPES (65600155 SHOWN)**



**C. SCREAMIN' EAGLE JET BLACK HEADER PIPES (80887-10 SHOWN)**



**D. SCREAMIN' EAGLE BUCKSHOT EXHAUST SHIELD KIT – CHROME**



**D. SCREAMIN' EAGLE BUCKSHOT EXHAUST SHIELD KIT – JET BLACK**



**D. SCREAMIN' EAGLE BUCKSHOT EXHAUST SHIELD KIT – BRUSHED NICKEL**



**E. SCREAMIN' EAGLE MUFFLER SHIELDS**

# SCREAMIN' EAGLE® 495

Sportster® Exhaust

## C. SCREAMIN' EAGLE® JET BLACK HEADER PIPES

Hide the blue. These Original Equipment-style Header Pipes have been finished with a unique jet black heat resistant coating and are a great accent to both chrome and black Buckshot exhaust shields. When exposed through the holes in the Buckshot shields, the black header pipe provides a sinister accent and hides the heat-tempered finish of the typical exhaust pipe. Easy to install using factory mounting hardware, the kit includes front and rear header pipe.

**65600155** **\$179.95**

Fits '14-later XL models.

**80887-10** **\$99.95**

Fits '04-'13 XL models.

## D. SCREAMIN' EAGLE BUCKSHOT EXHAUST SHIELD KIT

These custom shields feature a perforated "Buckshot" design that exposes the head pipe for a raw, rebellious look. Available in your choice of finishes, these exhaust shields are a perfect match for Original Equipment or Screamin' Eagle® mufflers and provide a consistent look from front to back. Manufactured to Original Equipment standards for exacting fit, the easy-to-install kit includes front and rear head pipe shields.

Fits '14-later XL models.

**65400137** Jet Black. **\$159.95**

**65400143** Chrome. **\$159.95**

Fits '04-'13 XL models.

**64601-10** Chrome. **\$149.95**

**64924-09** Jet Black. **\$149.95**

**64900128** Brushed Nickel. **\$149.95**

## E. SCREAMIN' EAGLE MUFFLER SHIELDS

Styled to complement the ballistic inlet shape of the Screamin' Eagle Street Performance Slip-On Mufflers. The rear shield features a deep embossed "Screamin' Eagle" signature script. Available in chrome, jet black and brushed nickel. Easy-to-install kit includes front and rear shields and mounting hardware.

Fits '07-later XL, Dyna® (except '08-later FXDF, FLD, FXDL and '10-later FXDWG) and Softail® models equipped with Screamin' Eagle Street Performance Mufflers.

**64806-07A** Chrome. **\$49.95**

**65400078** Jet Black. **\$129.95**

**65400079** Brushed Nickel. **\$149.95**

NOTE: Due to increased diameter of these mufflers some realignment of head pipes is usually required. It is recommended to replace exhaust port gaskets, P/N 65324-83A (stock) or P/N 17048-98 (performance), to avoid tendency of head pipes to return to original position when re-tightened.

NOTE: There is no warranty on exhaust pipes and mufflers with regard to any discoloration. Blueing is caused by tuning characteristics, cam timing, carburetor jetting, over-heating, etc. and is not caused by defective manufacturing.

*Notice: The prices appearing in this catalog are the manufacturer's suggested retail prices. Actual retail prices may vary.*



# 496 SCREAMIN' EAGLE®

Dyna® Exhaust

## A. SCREAMIN' EAGLE® STREET PERFORMANCE SLIP-ON MUFFLERS – DYNA® SHORTY DUAL

Factory engineers tuned these pipes to satisfy the most discriminating Harley enthusiast. Mufflers feature high-flowing internals to maximize performance and a rich, deep exhaust note that lets everyone know you're around. With the aggressive sound quality and performance comparable to Screamin' Eagle® II race-use mufflers, it's hard to believe they are street legal. Available in your choice of rich chrome or heat-resistant jet black ceramic finish. Jet black mufflers include matching muffler shield with a deep embossed Screamin' Eagle logo along the flank. Chrome mufflers allow for the reuse of stock muffler shields or the separate purchase of Chrome "Screamin' Eagle" Script Muffler Shields. EPA stamped, these mufflers are 50-state street legal on stock displacement engines.

Fits 50-state '07-later FXD, FXDB, FXDC, '07-'13 FXDL and '07-'08 FXDWG models with Shorty Dual exhaust. Installation requires separate purchase of Muffler Clamps P/N 65296-95A (Qty 2).

<b>80678-08</b>	Chrome.	<b>\$449.95</b>
<b>80794-10A</b>	Jet Black w/ Muffler Shields.	<b>\$499.95</b>



A. SCREAMIN' EAGLE STREET PERFORMANCE SLIP-ON SHORTY DUAL MUFFLERS – CHROME



A. SCREAMIN' EAGLE STREET PERFORMANCE SLIP-ON SHORTY DUAL MUFFLERS – JET BLACK W/ MUFFLER SHIELDS (SHOWN WITH JET BLACK EXHAUST SHIELD KIT)



A. SCREAMIN' EAGLE STREET PERFORMANCE SLIP-ON SHORTY DUAL MUFFLERS – JET BLACK W/ MUFFLER SHIELDS (SHOWN WITH BRUSHED NICKEL MUFFLER AND EXHAUST SHIELDS)

NOTE: There is no warranty on exhaust pipes and mufflers with regard to any discoloration. Blueing is caused by tuning characteristics, cam timing, carburetor jetting, over-heating, etc. and is not caused by defective manufacturing.

Notice: The prices appearing in this catalog are the manufacturer's suggested retail prices. Actual retail prices may vary.

# SCREAMIN' EAGLE® 497

Dyna® Exhaust

## B. SCREAMIN' EAGLE® STREET PERFORMANCE MUFFLERS – DYNA® STAGGERED DUAL

Make your statement before they see you coming. The throaty Screamin' Eagle® Street Performance sound sets the tone and the bold styling drives the note home. One-of-a-kind ballistic inlet shape flows back past the embossed "Screamin' Eagle" logo to the unique "Blunt Revolver" end treatment. Available in your choice of brilliant chrome or tough jet-black ceramic finish, the mufflers feature complementing end caps with cut-out chambers that expose the finish below for a bold contrast. Complete the look with Jet Black or Brushed Nickel Exhaust Shields (sold separately). Mufflers are 50-state street legal on 96CI or 103CI displacement models.

Fits '08-later FXDF and '10-later FXDWG models equipped with 96CI or 103CI engines. Installation requires separate purchase of Muffler Clamps P/N 65296-95A (Qty 2).

<b>80674-08A</b>	Chrome w/ Black End Caps.	<b>\$374.95</b>
<b>80601-09A</b>	Jet Black w/ Chrome End Caps.	<b>\$399.95</b>
<b>64900124</b>	Jet Black w/ Brushed Nickel End Caps.	<b>\$399.95</b>



**B. SCREAMIN' EAGLE STREET PERFORMANCE STAGGERED DUAL MUFFLERS – CHROME W/ BLACK END CAPS**



**B. SCREAMIN' EAGLE STREET PERFORMANCE STAGGERED DUAL MUFFLERS – JET BLACK W/ CHROME END CAPS (SHOWN WITH JET BLACK EXHAUST SHIELD KIT)**



**B. SCREAMIN' EAGLE STREET PERFORMANCE STAGGERED DUAL MUFFLERS – JET BLACK W/ BRUSHED NICKEL END CAPS (SHOWN WITH BRUSHED NICKEL EXHAUST SHIELD KIT)**

NOTE: There is no warranty on exhaust pipes and mufflers with regard to any discoloration. Blueing is caused by tuning characteristics, cam timing, carburetor jetting, over-heating, etc. and is not caused by defective manufacturing.

Notice: The prices appearing in this catalog are the manufacturer's suggested retail prices. Actual retail prices may vary.



# 498 SCREAMIN' EAGLE®

Dyna® Exhaust

## A. SCREAMIN' EAGLE® NIGHTSTICK DYNA® 2-INTO-1 SLIP-ON MUFFLERS

Tuned by the factory for the ultimate combination of improved performance, rich tone and legal sound levels, these 50-state street legal slip-on mufflers are the perfect match for your Dyna® Switchback™ model. The high-flow design of the external diffusion discs produces plenty of low-end "guts" to get your bike away from the light and a fat torque curve that gets you quickly around slow-moving traffic. The flared opening, multiple stainless steel diffusion discs and domed end cap deliver an aggressive raspy sound. Available in mirror-chrome and jet black finish, these long and lean pipes feature an embossed Screamin' Eagle® logo. Easy to install. EPA stamped.

Fits '12-later FLD models.

<b>80872-12</b>	Chrome.	<b>\$274.95</b>
<b>64900137</b>	Jet Black.	<b>\$329.95</b>

Fits '14-later FXDL models.

<b>64900243</b>	Chrome.	<b>\$299.95</b>
<b>64900242</b>	Jet Black.	<b>\$329.95</b>

## B. HARLEY-DAVIDSON® DYNA SLIP-ON MUFFLERS

Harley-Davidson® Slip-On Mufflers for Dyna models. Choose your style, slash down or baloney cut. These 50-state street legal mufflers offer great sound quality, improved performance and feature the "Harley-Davidson" script on the rear muffler.

Fits '95-'05 Dyna models.

<b>80366-99</b>	Slash Down.	<b>\$329.95</b>
<b>80104-99</b>	Baloney Cut.	<b>\$329.95</b>



A. SCREAMIN' EAGLE NIGHTSTICK 2-INTO-1 SLIP-ON MUFFLERS – FLD MODELS



A. SCREAMIN' EAGLE NIGHTSTICK 2-INTO-1 SLIP-ON MUFFLERS – FXDL MODELS (SHOWN WITH JET BLACK EXHAUST SHIELD KIT)



B. HARLEY-DAVIDSON DYNA SLIP-ON MUFFLERS – (SLASH DOWN SHOWN)

NOTE: There is no warranty on exhaust pipes and mufflers with regard to any discoloration. Blueing is caused by tuning characteristics, cam timing, carburetor jetting, over-heating, etc. and is not caused by defective manufacturing.

Notice: The prices appearing in this catalog are the manufacturer's suggested retail prices. Actual retail prices may vary.

# SCREAMIN' EAGLE® 499

Dyna® Exhaust



**C. SCREAMIN' EAGLE EXHAUST SHIELD KIT – DYNA SHORTY DUAL**

**C. SCREAMIN' EAGLE® EXHAUST SHIELD KIT – DYNA® SHORTY DUAL**

Extend the custom look along the bike's entire profile. These formed steel exhaust shields are available in your choice of unique jet black ceramic or warm brushed nickel finish that complements jet black Screamin' Eagle® Street Performance Slip-On Mufflers. Both finishes have survived stringent Harley-Davidson testing for durability and corrosion resistance. Manufactured to Original Equipment standards for exact fit, the easy-to-install kit includes front and rear head pipe shields.

Fits '06-later FXD, FXDB, FXDC, '06-'13 FXDL and '06-'08 FXDWG models with shorty dual exhaust.

<b>80821-10</b>	Jet Black.	<b>\$159.95</b>
<b>64900127</b>	Brushed Nickel.	<b>\$159.95</b>

**D. SCREAMIN' EAGLE EXHAUST SHIELD KIT – DYNA STAGGERED DUAL**

Add a custom touch to your ride. These formed steel exhaust shields are available in your choice of tough jet-black ceramic or unique electroless nickel plated finish that looks just right when paired with jet black Screamin' Eagle Street Performance Slip-On Mufflers. The warm look of the nickel complements both bright and satin paint colors and the jet-black coating adds a sinister look to your bike's profile. The slotted "tommy gun" cutouts expose the head pipe for a raw, rebellious attitude. Manufactured to Original Equipment standards for exact fit, this easy-to-install kit includes front and rear head pipe shields.

Fits '08-later FXDF and '10-later FXDWG models with forward controls.

<b>65247-09</b>	Jet Black.	<b>\$229.95</b>
<b>64900129</b>	Brushed Nickel.	<b>\$229.95</b>



**D. SCREAMIN' EAGLE EXHAUST SHIELD KIT – DYNA STAGGERED DUAL**

**E. SCREAMIN' EAGLE EXHAUST SHIELD KIT – DYNA 2-INTO-1**

Extend the blacked-out look along the bike's entire profile. These formed steel exhaust shields feature a unique jet black ceramic coating that complements the jet black Screamin' Eagle Street Performance Slip-On Mufflers. The jet black coating maintains its uniform black finish and has survived stringent Harley-Davidson testing for durability and corrosion resistance. Manufactured to Original Equipment standards for exacting fit, the easy-to-install kit includes front and rear head pipe shields.

Fits '12-later FLD models.

<b>65400088</b>	Jet Black.	<b>\$199.95</b>
-----------------	------------	-----------------

Fits '14-later FXDL models equipped with Nightstick Muffler P/N 64900242 or 64900243.

<b>65400172</b>	Jet Black.	<b>\$199.95</b>
-----------------	------------	-----------------

**F. SCREAMIN' EAGLE MUFFLER SHIELDS**

Styled to complement the ballistic inlet shape of the Screamin' Eagle Street Performance Slip-On Mufflers. The rear shield features a deep embossed "Screamin' Eagle" signature script. Available in chrome, jet black and brushed nickel. Easy-to-install kit includes front and rear shields and mounting hardware.

Fits '07-later XL, Dyna® (except '08-later FXDF, FLD, FXDL and '10-later FXDWG) and Softail® models equipped with Screamin' Eagle Street Performance Mufflers.

<b>64806-07A</b>	Chrome.	<b>\$49.95</b>
<b>65400078</b>	Jet Black.	<b>\$129.95</b>
<b>65400079</b>	Brushed Nickel.	<b>\$149.95</b>

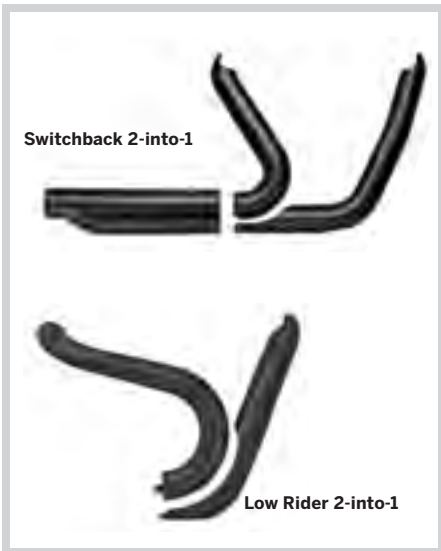

Switchback 2-into-1

Low Rider 2-into-1

**E. SCREAMIN' EAGLE EXHAUST SHIELD KIT**



**F. SCREAMIN' EAGLE MUFFLER SHIELDS**

Notice: The prices appearing in this catalog are the manufacturer's suggested retail prices. Actual retail prices may vary.

SCREAMIN' EAGLE



# 500 SCREAMIN' EAGLE®

Softail® Exhaust

## A. SCREAMIN' EAGLE® STREET PERFORMANCE SLIP-ON MUFFLERS – SOFTAIL® SHORTY DUAL

Tough sound, nice performance. Street Performance Mufflers feature high-flowing internals to maximize performance, developing improved low end grunt and passing power you can feel. The ballistic-shaped inlet and tuned baffles produce a rich, aggressive exhaust note that lets everyone know you're around. Available in rich chrome or heat-resistant jet black finish, jet black mufflers include matching muffler shield with a deep embossed "Screamin' Eagle" logo along the flank. Chrome mufflers allow for the reuse of stock muffler shields or the separate purchase of Chrome "Screamin' Eagle" Script Muffler Shields. EPA stamped, these mufflers are 50-state street legal on stock displacement engines.

Fits '07-later Softail® models models equipped with Staggered Shorty Dual exhaust. Installation requires separate purchase of Muffler Clamps P/N 65296-95A (Qty 2).

**80679-12** Chrome. **\$449.95**

Fits '07-later Softail models models equipped with Staggered Shorty Dual exhaust. Installation requires separate purchase of Muffler Clamps P/N 65296-95A (Qty 2).

**80813-12** Jet Black w/ Muffler Shields. **\$499.95**



A. SCREAMIN' EAGLE STREET PERFORMANCE SHORTY DUAL SLIP-ON MUFFLERS – CHROME



A. SCREAMIN' EAGLE STREET PERFORMANCE SLIP-ON SHORTY DUAL MUFFLERS – JET BLACK W/ MUFFLER SHIELDS (SHOWN WITH JET BLACK EXHAUST SHIELD KIT)

NOTE: There is no warranty on exhaust pipes and mufflers with regard to any discoloration. Blueing is caused by tuning characteristics, cam timing, carburetor jetting, over-heating, etc. and is not caused by defective manufacturing.

Notice: The prices appearing in this catalog are the manufacturer's suggested retail prices. Actual retail prices may vary.

# SCREAMIN' EAGLE® 501

Softail® Exhaust

## B. SCREAMIN' EAGLE® STREET PERFORMANCE SLIP-ON MUFFLERS – SOFTAIL® SHOTGUN

Tough sound, nice performance. Street Performance Mufflers feature high-flowing internals to maximize performance, developing improved low end grunt and passing power you can feel. The ballistic-shaped inlet and tuned baffles produce a rich, aggressive exhaust note that lets everyone know you're around. Available in rich chrome or heat-resistant jet black finish, these mufflers finish your bike's adrenaline-driven look. Jet black mufflers include matching Screamin' Eagle® signature script muffler shields. Chrome mufflers allow for the reuse of stock muffler shields or the separate purchase of Chrome "Screamin' Eagle" Script Muffler Shields. EPA stamped, these mufflers are 50-state street legal on stock displacement engines.

Fits '07-later FXS, FLS, FLSTN and FLSTSB models equipped with shotgun exhaust. Installation requires separate purchase of Muffler Clamps P/N 65296-95A (Qty 2).

<b>80681-12</b>	Chrome.	<b>\$449.95</b>
<b>80781-12</b>	Jet Black w/ Muffler Shields.	<b>\$499.95</b>

Fits '07-later FLSTF, FLSTFB and FXSTD models equipped with shotgun exhaust. Installation requires separate purchase of Muffler Clamps P/N 65296-95A (Qty 2).

<b>80680-12</b>	Chrome.	<b>\$449.95</b>
<b>80621-12</b>	Jet Black w/ Muffler Shields.	<b>\$499.95</b>



**B. SCREAMIN' EAGLE STREET PERFORMANCE SLIP-ON SHOTGUN MUFFLERS – CHROME, SLASH DOWN (SHOWN WITH SCREAMIN' EAGLE MUFFLER SHIELDS)**



**B. SCREAMIN' EAGLE STREET PERFORMANCE SLIP-ON SHOTGUN MUFFLERS – JET BLACK W/ MUFFLER SHIELDS, SLASH DOWN (SHOWN WITH JET BLACK EXHAUST SHIELDS)**

SCREAMIN' EAGLE

NOTE: There is no warranty on exhaust pipes and mufflers with regard to any discoloration. Blueing is caused by tuning characteristics, cam timing, carburetor jetting, over-heating, etc. and is not caused by defective manufacturing.

Notice: The prices appearing in this catalog are the manufacturer's suggested retail prices. Actual retail prices may vary.



# 502 SCREAMIN' EAGLE®

Softail® Exhaust

## A. SCREAMIN' EAGLE® FAT EXHAUST SHIELD KIT

These Fat Exhaust Shields transform your bike into a bruiser by giving the head pipes a thick and muscular appearance. This kit replaces the stock header heat shields with a large diameter version that blends with the outer diameter of the muffler, giving the appearance of a larger exhaust system without compromising sound or performance. This easy-to-install kit includes front and rear heat shields.

Fits '07-later FXS, FLSTF and FLSTFB models.

<b>65400001</b>	Chrome.	<b>\$199.95</b>
<b>65400082</b>	Jet Black.	<b>\$199.95</b>



A. SCREAMIN' EAGLE FAT EXHAUST HEAT SHIELD KIT – CHROME

## B. SCREAMIN' EAGLE EXHAUST SHIELD KIT – SOFTAIL®

Extend the blacked-out look along the bike's entire profile. These formed steel exhaust shields feature a unique jet black ceramic coating that complements the jet black Screamin' Eagle® Street Performance Slip-On Mufflers. The jet black coating maintains its uniform black finish and has survived stringent Harley-Davidson testing for durability and corrosion resistance. Manufactured to Original Equipment standards for exacting fit, the easy-to-install kit includes front and rear head pipe shields.

<b>1. 80817-10A</b>	Jet Black.	<b>\$189.95</b>
Fits '07-later FLSTF, FLSTFB, FXS and FXSTD models equipped with shotgun exhaust.		
<b>2. 80829-10A</b>	Jet Black.	<b>\$189.95</b>
Fits '07-later FLS, FLSTSB and FLSTN models.		
<b>3. 80818-10</b>	Jet Black.	<b>\$159.95</b>
Fits FXSB, FXSBSE, '08-'11 FXCW and FXCWC models equipped with shorty dual exhaust.		



A. SCREAMIN' EAGLE FAT EXHAUST HEAT SHIELD KIT – JET BLACK



B. SCREAMIN' EAGLE EXHAUST SHIELD KIT – SOFTAIL

Notice: The prices appearing in this catalog are the manufacturer's suggested retail prices. Actual retail prices may vary.

# SCREAMIN' EAGLE® 503

Touring Exhaust

NEW



C. SCREAMIN' EAGLE HIGH-FLOW EXHAUST SYSTEM WITH NIGHTSTICK MUFFLERS

## C. SCREAMIN' EAGLE® HIGH-FLOW EXHAUST SYSTEM WITH NIGHTSTICK MUFFLERS

The Screamin' Eagle® High-Flow Exhaust system provides bolt-on performance by reducing catalyst restrictions and improving exhaust flow. Optimized for CVO™ 110 and Screamin' Eagle Stage Kit engine configurations producing 80-100+ HP, the kit replaces the stock head pipe and mufflers with large diameter free-flowing head pipes and matching mufflers. The muffler inlet diameter has been increased to 2.25" to enhance exhaust gas scavenging and the catalysts have been relocated to the mufflers to enhance flow. The proof is in the numbers – this system can produce 5-7 hp gains on a 110ci motor and 8-10 hp gains on a 120ci motor when compared to the Original Equipment exhaust system. Extra oxygen sensor bungs permit attachment of tuning equipment. Kit includes head pipe, 2.25" inlet Nightstick mufflers with catalysts and a collector and crossover tube heat shield. 50-state legal.

64800022

\$1,299.95

Fits '10-'15 Touring models equipped with a 103 or 110CI engine.

NEW

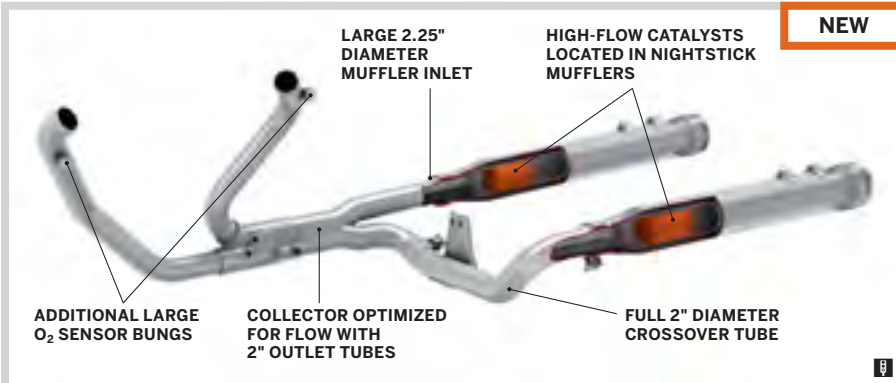

C. SCREAMIN' EAGLE HIGH-FLOW EXHAUST SYSTEM WITH NIGHTSTICK MUFFLERS

### TWIN CAM 103 STAGE 4 HIGH-FLOW VS. OE EXHAUST W/STREET CANNONS

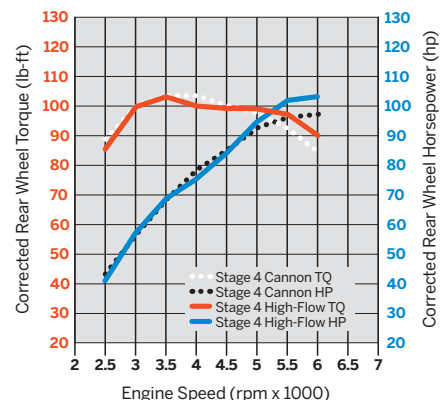

NEW



C. SCREAMIN' EAGLE HIGH-FLOW EXHAUST SYSTEM WITH NIGHTSTICK MUFFLERS

NOTE: There is no warranty on exhaust pipes and mufflers with regard to any discoloration. Blueing is caused by tuning characteristics, cam timing, carburetor jetting, over-heating, etc. and is not caused by defective manufacturing.

Notice: The prices appearing in this catalog are the manufacturer's suggested retail prices. Actual retail prices may vary.

SCREAMIN' EAGLE



# 504 SCREAMIN' EAGLE®

Touring Exhaust

## A. SCREAMIN' EAGLE® NIGHTSTICK DIFFUSION DISC SLIP-ON MUFFLERS

Tuned by the factory for the ultimate combination of improved performance, rich tone and legal sound levels, these 50-state street legal slip-on mufflers are the perfect match for your Touring motorcycle. The high-flow design of the external diffusion discs produces plenty of low-end "guts" for getting your fully-loaded bike away from the light and a fat torque curve that gets you quickly around a slow-moving RV. Available in your choice of mirror-chrome or tough jet-black ceramic finishes, these long and lean mufflers feature an embossed Screamin' Eagle® logo and are flared to an aggressive 4.0" opening at the rear. The multiple stainless steel diffusion discs are capped with a complementing end cap and stainless hardware for a classic finishing touch. These slip-on mufflers are easy to install and are available to fit both 2-into-1 and traditional 2-into-2 Touring model exhaust configurations. Mufflers are EPA stamped.

### SCREAMIN' EAGLE NIGHTSTICK 2-INTO-2 SLIP-ON MUFFLERS

Maximize the performance of your dual exhaust-equipped '10-later Touring model. The unique, raspy sound of these diffusion disc mufflers provides a style all its own. Designed for easy installation on the Original Equipment header pipe and muffler hanger, this long and lean muffler provides enhanced airflow and back pressure to boost the performance and sound quality of your bike. EPA stamped, this muffler is 50-state street legal on stock displacement engines.

Fits 50-state '10-later Touring models with dual exhaust. Also fits '09 California Touring models. Does not fit Trike models. Requires separate purchase of Muffler Clamps P/N 65296-95A (Qty 2).

<b>64900093</b>	Chrome.	<b>\$499.95</b>
<b>64900091</b>	Jet Black.	<b>\$529.95</b>

### SCREAMIN' EAGLE NIGHTSTICK 2-INTO-1 SLIP-ON MUFFLERS

Maximize the performance of your 2-into-1 exhaust-equipped 2010 Street Glide® or Road Glide® model. Designed for easy installation on the Original Equipment header pipe and muffler hanger, this long and lean muffler provides the right combination of airflow and back pressure to boost the performance and sound quality of your bike. EPA stamped, this muffler is 50-state street-legal on stock displacement engines.

Fits 50-state '10 FLHX and FLTRX models with Original Equipment 2-into-1 exhaust. Installation requires separate purchase of Muffler Clamp P/N 65296-95A (Qty 2). Also fits '10-later Touring models equipped with 2-into-1 Head Pipe Kit.

<b>80881-10A</b>	Chrome.	<b>\$249.95</b>
<b>80846-10</b>	Jet Black.	<b>\$279.95</b>



A. SCREAMIN' EAGLE NIGHTSTICK 2-INTO-2 SLIP-ON MUFFLERS – CHROME



A. SCREAMIN' EAGLE NIGHTSTICK 2-INTO-2 SLIP-ON MUFFLERS – JET BLACK



A. SCREAMIN' EAGLE NIGHTSTICK 2-INTO-2 SLIP-ON MUFFLERS – CHROME



A. SCREAMIN' EAGLE NIGHTSTICK 2-INTO-2 SLIP-ON MUFFLERS – JET BLACK

NOTE: There is no warranty on exhaust pipes and mufflers with regard to any discoloration. Blueing is caused by tuning characteristics, cam timing, carburetor jetting, over-heating, etc. and is not caused by defective manufacturing.

Notice: The prices appearing in this catalog are the manufacturer's suggested retail prices. Actual retail prices may vary.

# SCREAMIN' EAGLE® 505

Touring Exhaust

## B. SCREAMIN' EAGLE® STREET PERFORMANCE SLIP-ON MUFFLERS

Street Performance one-piece touring mufflers feature an aggressive exhaust note and high-flowing internals to maximize performance. These easy-to-install slip-on mufflers feature free-flowing internals to combine aggressive sound quality with performance comparable to Screamin' Eagle® II race-use mufflers. Available in your choice of mirror-chrome or tough jet-black ceramic finish, these street legal mufflers feature a new ballistic-shape inlet and a deep embossed "Screamin' Eagle" signature script. EPA stamped.

Fits 50-state '09-later Touring models (except '10 FLHX and FLTRX) equipped with Twin Cam 96™ engines. Does not fit Trike models. Installation requires separate purchase of Muffler Clamps P/N 65296-95A (Qty. 2).

<b>80721-09</b>	Chrome.	<b>\$399.95</b>
<b>80742-09A</b>	Jet Black.	<b>\$399.95</b>

## C. SCREAMIN' EAGLE FATSHOTZ 2-INTO-2 SLIP-ON MUFFLERS

Provide a performance and style boost to your 2-into-2 exhaust-equipped Touring motorcycle. Designed for easy installation on the Original Equipment header pipes and muffler hangers, these mirror-chrome flared mufflers are tuned to maximize airflow while keeping the rich exhaust note within the legal limits. EPA stamped, these mufflers are 50-state street legal on stock displacement engines.

**80847-10** **\$429.95**

Fits 50-state '10-later Touring and Trike models with dual exhaust (except '14-later FLHRSE and FLHTKSE). '10 FLHX and FLTRX models require separate purchase of Touring 2-into-2 Head Pipe Kit. Also fits '09 California Touring and Trike models. Installation requires separate purchase of Muffler Clamps P/N 65296-95A (Qty. 2).



B. SCREAMIN' EAGLE STREET PERFORMANCE SLIP-ON MUFFLERS – CHROME



B. SCREAMIN' EAGLE STREET PERFORMANCE SLIP-ON MUFFLERS – JET BLACK



C. SCREAMIN' EAGLE FATSHOTZ 2-INTO-2 SLIP-ON MUFFLERS

NOTE: There is no warranty on exhaust pipes and mufflers with regard to any discoloration. Blueing is caused by tuning characteristics, cam timing, carburetor jetting, over-heating, etc. and is not caused by defective manufacturing.

Notice: The prices appearing in this catalog are the manufacturer's suggested retail prices. Actual retail prices may vary.



# 506 SCREAMIN' EAGLE®

Touring Exhaust

## A. SCREAMIN' EAGLE® THUNDER STREET PERFORMANCE SLIP-ON MUFFLERS

Hear the thunder long before the storm hits. Screamin' Eagle® 3.5" Performance Mufflers provide increases in torque and horsepower you can feel. Designed to work with the header-mounted catalyts, these pipes feature an open baffle design that produces a rich, deep base note that meets 50-state sound level requirements. Internal insulation protects the rich chrome finish from heat and discoloration. Fitted with your choice of stylish end caps (sold separately), these easy-to-install slip-on mufflers make the styling and sound statement you are looking for.

Fits 50-state '10-later Touring models (except '10 FLHX and FLTRX and models equipped with 110 CI engines). Also fits '09 California Touring models. Does not fit Trike models. Requires separate purchase of End Cap Kit and Muffler Clamps P/N 65296-95A (Qty 2).

<b>65115-10</b>	Chrome.	<b>\$379.95</b>
<b>65430-10</b>	Jet Black.	<b>\$399.95</b>

## B. SCREAMIN' EAGLE END CAPS

These End Cap kits allow you to personalize your Screamin' Eagle Street Performance Touring Mufflers. Available in your choice of styles, these easy-to-install caps are dressed with the same finish as the mufflers and exhaust shields for a consistent look front to back. Sold in pairs.

Fits Touring models equipped with Screamin' Eagle 3.5" diameter Thunder Street Performance Slip-On Mufflers P/N 65115-10 and 65430-10.

<b>1. 80629-10</b>	Piston.	<b>\$99.95</b>
<b>2. 80630-10</b>	Slash Cut.	<b>\$99.95</b>
<b>3. 65100013</b>	Slotted – Black with Chrome Spears.	<b>\$149.95</b>
<b>4. 65100014</b>	Slotted – Chrome with Black Spears.	<b>\$149.95</b>
<b>5. 65100029</b>	Jet Black – Screamin' Eagle Script.	<b>\$129.95</b>
<b>6. 65100035</b>	Burst Collection.	<b>\$159.95</b>



**A. SCREAMIN' EAGLE THUNDER STREET PERFORMANCE MUFFLERS – CHROME (SHOWN WITH PISTON END CAPS)**



**A. SCREAMIN' EAGLE THUNDER STREET PERFORMANCE MUFFLERS – JET BLACK (SHOWN WITH BLACK WITH CHROME SPEARS END CAPS)**



**B. SCREAMIN' EAGLE 3.5" END CAPS**

*Notice: The prices appearing in this catalog are the manufacturer's suggested retail prices. Actual retail prices may vary.*

# SCREAMIN' EAGLE® 507

Touring Exhaust



**C. SCREAMIN' EAGLE STREET CANNON PERFORMANCE MUFFLERS – CHROME  
(SHOWN WITH BILLET TAPERED SLASH END CAPS)**

## C. SCREAMIN' EAGLE® STREET CANNON PERFORMANCE SLIP-ON MUFFLERS

Cue the orchestra. We tuned these mufflers to provide an exhaust note with some extra deep bass. You get the rumble you want and enhance that famous Harley sound, while preserving the peace with your neighbors. The tuned baffles work with the large internal volume to strike the perfect balance required to deliver performance that you can feel in your gut. The large 4.0" diameter Street Cannons provide free flow of exhaust gases with just the right amount of back pressure for a smooth-running ride. The die-cast Screamin' Eagle® medallion adds a rich touch to your bike's profile and a large selection of end cap designs are available (sold separately) to provide the perfect finishing touch.

Fits 50-state '09-later Touring and Trike models (except '10 FLHX and FLTRX and models equipped with 110CI engines). Installation requires separate purchase of Muffler Clamps P/N 65296-95A (Qty 2). Requires separate purchase of end caps.

<b>64900186</b>	Chrome.	<b>\$399.95</b>
<b>64900187</b>	Jet Black.	<b>\$449.95</b>

## D. MUFFLER BRACKET COVER KIT

Stamped-steel cover conceals the Original Equipment exhaust brackets. Contoured for a custom fit, these easy-to-install covers add a distinctive finishing touch. Available in mirror-chrome or black finish to match your customizing style (sold in pairs).

Fits '97-'13 Touring models. Fits Screamin' Eagle Street Performance Touring 4" Mufflers (except P/N 64900093 and 64900091). Does not fit with Fishtail 4.0" Muffler End Cap P/N 65100017. Does not fit with Screamin' Eagle 3.5" Mufflers.

<b>80812-10</b>	Black.	<b>\$59.95</b>
<b>80716-08</b>	Chrome.	<b>\$59.95</b>



**C. SCREAMIN' EAGLE STREET CANNON PERFORMANCE MUFFLERS – JET BLACK  
(SHOWN WITH BLUNT REVOLVER END CAPS)**



**D. MUFFLER BRACKET COVER KIT – CHROME**



**D. MUFFLER BRACKET COVER KIT – BLACK**

Notice: The prices appearing in this catalog are the manufacturer's suggested retail prices. Actual retail prices may vary.



# 508 SCREAMIN' EAGLE®

Touring Exhaust

## A. THE BURST COLLECTION – 4" END CAPS

Sculpted machining sends reflections of light in all directions. Burst Collection Muffler End Caps feature a rich black anodized finish that is machined to expose the highlights of raw aluminum. The contrasting cut-back look makes a powerful visual statement and works great with both chrome and jet black mufflers.

**65100054** **\$199.95**

Fits Touring and Trike models equipped with Screamin' Eagle® Street Performance Touring 4" End Cap Mufflers. Does not fit 4" CVO™ Touring mufflers.

## B. SCREAMIN' EAGLE® 4" END CAPS

These End Cap Kits allow you to personalize your Screamin' Eagle Street Performance Touring Mufflers. Available in your choice of styles, these easy-to-install caps are dressed with the same finish as the mufflers and exhaust shields for a consistent look front to back. Sold in pairs, the kit includes all required mounting hardware.

Fits Touring and Trike models equipped with Screamin' Eagle Street Performance Touring 4" End Cap Mufflers. Does not fit 4" CVO Touring mufflers.

<b>65100016</b>	Revolver.	<b>\$79.95</b>
<b>65100015</b>	Piston.	<b>\$79.95</b>
<b>65100019</b>	Slash Up/Down/Out.	<b>\$79.95</b>
<b>65100018</b>	Billet Tapered Slash.	<b>\$129.95</b>
<b>65100017</b>	Fishtail.	<b>\$129.95</b>
<b>65100028</b>	Jet Black.	<b>\$129.95</b>
<b>80611-09</b>	Blunt Revolver.	<b>\$109.95</b>



**A. THE BURST COLLECTION – 4" END CAPS**



**B. SCREAMIN' EAGLE 4" END CAPS – REVOLVER**



**B. SCREAMIN' EAGLE 4" END CAPS – PISTON**



**B. SCREAMIN' EAGLE 4" END CAPS – SLASH UP/DOWN/OUT**



**B. SCREAMIN' EAGLE 4" END CAPS – BILLET TAPERED SLASH**



**B. SCREAMIN' EAGLE 4" END CAPS – FISHTAIL**



**B. SCREAMIN' EAGLE 4" END CAPS – JET BLACK**



**B. SCREAMIN' EAGLE 4" END CAPS – BLUNT REVOLVER**

*Note: The prices appearing in this catalog are the manufacturer's suggested retail prices. Actual retail prices may vary.*

# SCREAMIN' EAGLE® 509

Touring Exhaust



**C. SCREAMIN' EAGLE LASER EXHAUST SHIELD KIT – CHROME WITH CHROME SCREENS**

## C. SCREAMIN' EAGLE® LASER EXHAUST SHIELD KIT

Show-winning style. This kit replaces the factory exhaust shields with a unique and attention-getting design. The shields feature laser cut openings that are filled with tightly-woven mesh that delivers a modern high performance look. Available in chrome or jet black ceramic, the finish is a perfect match for Original Equipment or Screamin' Eagle® mufflers. The easy-to-install kits include front and rear header shield and collector shield.

Fits '09-later Touring and Trike models (except '10 FLHX and FLTRX).

<b>65400064</b>	Chrome with Chrome Screens.	<b>\$299.95</b>
<b>65400117</b>	Jet Black with Stainless Steel Screens.	<b>\$349.95</b>

## D. SCREAMIN' EAGLE EXHAUST SHIELD KIT – TOURING

Available for 2-into-1 and 2-into-2 exhaust systems, these formed steel exhaust shields feature a unique jet black ceramic coating that complements the jet black Screamin' Eagle Street Performance Slip-On Mufflers. The jet black coating maintains its uniform black finish and has survived stringent Harley-Davidson testing for durability and corrosion resistance. Manufactured to Original Equipment standards for exacting fit, the easy-to-install kit includes front and rear head pipe shields.

**1. 64981-09** Jet Black 2-into-2 Exhaust. **\$249.95**  
Fits '09-later Touring and Trike models (except '10 FLHX and FLTRX).

**2. 66906-10** Jet Black 2-into-1 Exhaust. **\$199.95**  
Fits '10 FLHX and FLTRX models with Original Equipment 2-into-1 exhaust.



**C. SCREAMIN' EAGLE LASER EXHAUST SHIELD KIT – CHROME WITH CHROME SCREENS**



**C. SCREAMIN' EAGLE LASER EXHAUST SHIELD KIT**

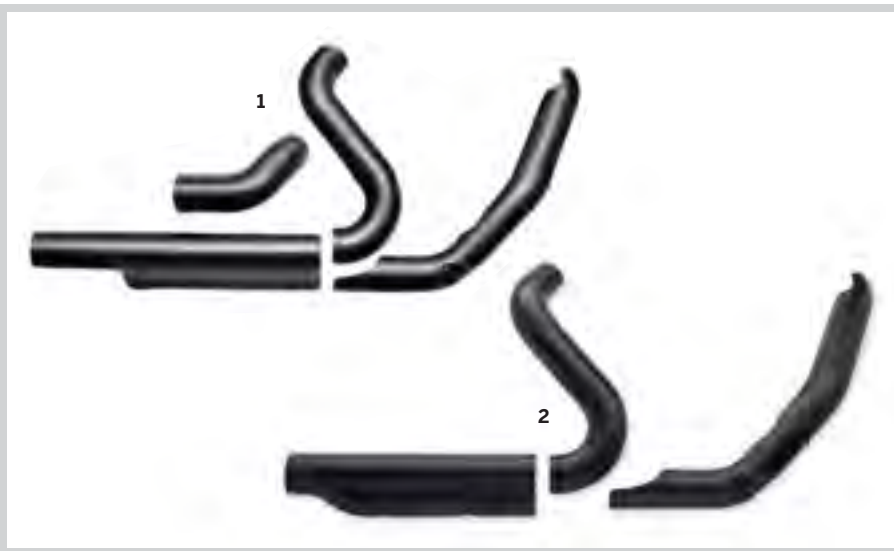

**D. SCREAMIN' EAGLE EXHAUST SHIELD KIT – TOURING**

SCREAMIN' EAGLE

*Notice: The prices appearing in this catalog are the manufacturer's suggested retail prices. Actual retail prices may vary.*



# 510 SCREAMIN' EAGLE®

Street Tuner

## SCREAMIN' EAGLE® STREET PERFORMANCE TUNER KIT

The Screamin' Eagle® Street Performance Tuner is designed to simplify management of street legal performance calibrations as EPA/CARB-compliant performance modifications are made. Once installed, the kit will allow you to upload the latest ECM calibrations for your bike's legal state-of-tune. Start with a high-flow air cleaner and Street Performance mufflers and upload the calibration that provides the best performance mix. Add a Big Bore Stage I or Stage II Kit later and simply download the proper ECM calibration to match the model and hardware. Plus, you have online access to the latest factory calibrations.

The kit includes the Vehicle Communications Interface (VCI) module with on-board memory that can record up to 15 minutes of run-time data. The module will store information on up to 27 variables that can be downloaded to your PC via an optional USB cable, allowing the rider or technician to view and evaluate engine operating parameters. With the included software, you can download and view the bike's air/fuel ratio, O2 sensor readings, engine speed and temperature, RPM and vehicle speed, throttle position, spark advance and many more performance characteristics. The VCI will also record and display service codes for troubleshooting and diagnostics.

### The Street Tuner software includes impressive features:

- Smart Tune Live – a dynamic and visual method to track and capture engine data simply by running the vehicle through a range of RPM and Throttle Positions. This feature reduces the time to modify existing VE (Volumetric Efficiency) tables which are then analyzed and tuned. Smart Tune Live works on models with factory-installed O2 sensors only.
- Interpolation of missing data derived from recordings, which reduces analysis time by automatically generating data that might be missed in the recording process.
- Viewable data meters doubled from 4 to 8 allowing users to monitor more real-time data. Users can now save and restore data meter configurations which are viewable in both traditional data modes and the new Smart Tune Live.
- Increased sampling rate to take advantage of the faster ECM data speeds found on select '11-later models (CAN protocol).
- Revised tuning tree with intuitive double click features.

NOTE: Street Tuner permits limited tunability within the emissions range to optimize drivability without compromising emission levels. It also features expanded tuning options outside of the emissions range to optimize performance.

### 4100008B \$249.95

For use with '14-later XL and '07-later EFI Dyna®, Softail® and Touring models. Model year '15-later Dyna, Softail and Touring models and model year '14 and '15 XL pending regulatory approval.

### Also available:

#### SCREAMIN' EAGLE TUNER CABLE KIT

Cable kit provides all necessary connections between motorcycle, VCI and computer and permits downloading calibrations with the Street Tuner and Super Tuner software. Kit includes two cables; computer USB to VCI box and VCI box to vehicle.

### 32184-08A \$45.95

For use with '01-later VRSC™, '01-'13 EFI XL and XR, '01-'11 EFI Dyna®, '01-'11 EFI Softail®, '02-'13 EFI Touring and '09-'13 Trike models. Also for use with VRSXSE Destroyer® race bike.

### 41000018 \$45.95

For use with '14-later XL, '12-later Dyna, '11-later Softail, '14-later Touring and '14-later Trike models.



SCREAMIN' EAGLE STREET PERFORMANCE TUNER KIT – SOFTWARE



SCREAMIN' EAGLE STREET PERFORMANCE TUNER VCI MODULE



SCREAMIN' EAGLE TUNER CABLE

# SCREAMIN' EAGLE® 511

XL Stage Kits



## SCREAMIN' EAGLE® SPORTSTER® 883CC TO 1200CC STAGE I CONVERSION KIT\*

Make your Iron 883™ roar. This complete conversion kit will alter the personality of your 883-equipped Sportster® model. Designed to bring your XL883 model up to XL1200 specifications, this kit includes Sportster Stage I Air Cleaner Kit, XL1200 Cylinder Heads and XL1200 Cylinders and Pistons. Kit includes cylinders and cylinder heads. No case machining is required for installation. Street legal when used with stock mufflers. All models require ECM calibration\* (priced separately).

<b>29784-07</b>	Black Highlighted. Fits '07-later XL883 models.	<b>\$1,199.95</b>
<b>30003-10</b>	Black Non-Highlighted. Fits '08-later XL883 models.	<b>\$1,199.95</b>

\*Recalibration is required for proper installation. See Dealer for details. Labor cost not included.

When installed by an authorized Harley-Davidson® Dealer at the time of vehicle delivery, these kits do not impact the vehicle's limited warranty.

**Sportster 883cc Stock vs. 1200cc Stage I Kit**  
(Shown with SE Performance Mufflers)

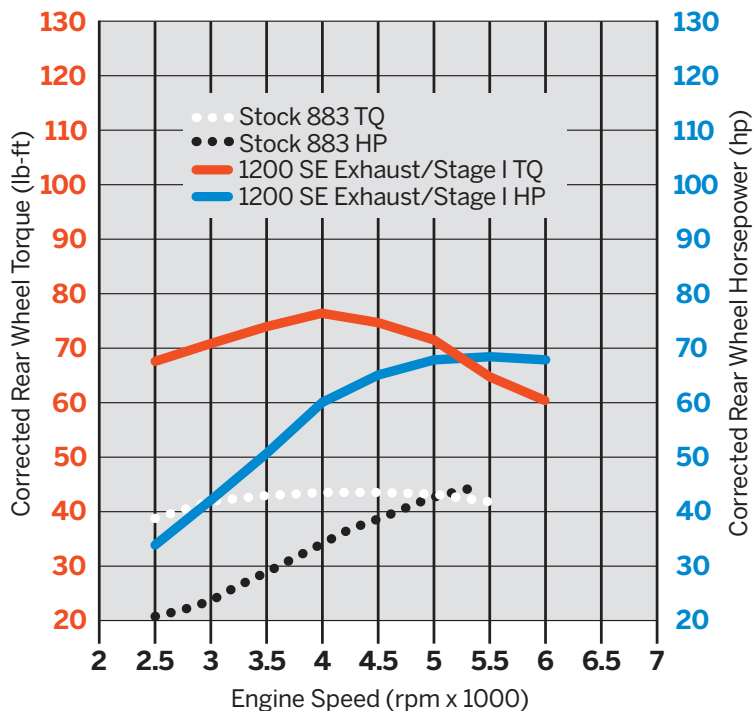

**SCREAMIN' EAGLE SPORTSTER 883CC TO 1200CC STAGE I STREET LEGAL CONVERSION KIT**

Notice: The prices appearing in this catalog are the manufacturer's suggested retail prices. Actual retail prices may vary.

SCREAMIN' EAGLE



# 512 SCREAMIN' EAGLE®

## Twin Cam Stage Kits

### SCREAMIN' EAGLE® BIG BORE STAGE I KIT FOR EFI MODELS – 103 CUBIC INCHES\*

This Big Bore Kit lets you increase the displacement of your Twin Cam 96™ engine-equipped model from 96 cubic inches (1584cc) to 103 cubic inches (1690cc). Includes Big Bore cylinders, Big Bore flat top piston assemblies and a Stage I Air Cleaner Kit with one-piece back plate, integral breathers, all mounting hardware and gaskets. A high-performance clutch spring is included to provide the additional clutch capacity required by the extra torque. Requires separate purchase of primary cover gasket. This kit is street legal when used with stock mufflers. (Not all components shown.) All EFI-equipped models require ECM calibration\* (priced separately).

\*Recalibration is required for proper installation and will allow engine to rev to 6200 RPM. See Dealer for details. Labor cost not included.

**29903-07A** Black Highlighted. **\$699.95**  
Fits all '07 Twin Cam and '08-later Softail® models equipped with a Twin Cam 96 engine.\*

**27535-08** Black Highlighted. **\$699.95**  
Fits '08-later Dyna® models equipped with a Twin Cam 96 engine.\*

**27539-08A** Black Highlighted. **\$699.95**  
Fits '08-'11 Touring models equipped with a Twin Cam 96 engine.

**NOTICE:** Installation of automatic or manual compression releases on large displacement engines is highly recommended.

When installed by an authorized Harley-Davidson® Dealer at the time of vehicle delivery, these kits do not impact the vehicle's limited warranty.



Twin Cam 96 Stock vs. 103CI Stage I Kit

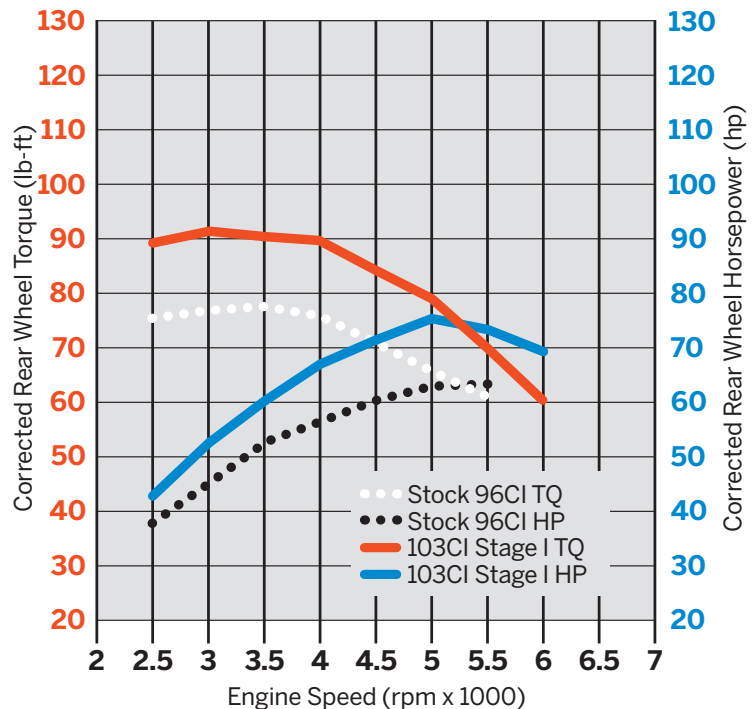

### SCREAMIN' EAGLE BIG BORE STAGE I KIT FOR EFI MODELS – 103 CUBIC INCHES

Notice: The prices appearing in this catalog are the manufacturer's suggested retail prices. Actual retail prices may vary.

# SCREAMIN' EAGLE® 513

Twin Cam Stage Kits



## SCREAMIN' EAGLE® BIG BORE STAGE II KIT FOR EFI MODELS – 103 CUBIC INCHES\*

The Stage II Big Bore Kit provides the parts you need to increase the horsepower of your EFI-equipped model. The kit increases the displacement of your Twin Cam-equipped model from 96 cubic inches (1584cc) to 103 cubic inches (1690cc). Includes Stage II (SE-255) cams, Big Bore cylinders, Big Bore flat top pistons, rings, pins, clips and a Stage I Air Cleaner Kit with one-piece back plate, integral breathers, all mounting hardware and gaskets. Also includes a high performance clutch spring. Separate purchase of cam spacers is recommended. Requires separate purchase of primary cover gasket. Not all components shown. California kits are street legal on California pollution controlled vehicles when used with Original Equipment mufflers. All EFI-equipped models require ECM calibration\* (priced separately).

\*Recalibration is required for proper installation and will allow engine to rev to 6200 RPM. See Dealer for details. Labor cost not included.

Fits 50-state '10-later Softail® models equipped with a Twin Cam 96™ engine. Also fits '08-'09 California Softail models.\*

<b>27543-08</b>	Black Highlighted.	<b>\$949.95</b>
<b>16500046A</b>	Black Non-Highlighted.	<b>\$949.95</b>

Fits 50-state '10-'11 Touring models equipped with Twin Cam 96 engine. Also fits '08-'09 California Touring models. '10 FLHX and FLTRX models require separate purchase of 2-into-2 Head Pipe and mufflers.

<b>27557-08</b>	Black Highlighted.	<b>\$949.95</b>
-----------------	--------------------	-----------------

Fits 50-state '10-later Dyna® models equipped with a Twin Cam 96 engine. Also fits '08-'09 California Dyna models (except FXDF and FXDWG).\*

<b>27545-08</b>	Black Highlighted.	<b>\$949.95</b>
-----------------	--------------------	-----------------

Fits 49-state '09 Touring models. Not street legal in California.\* Kit includes catalyst head pipe.

<b>27564-09A</b>	Black Highlighted.	<b>\$949.95</b>
------------------	--------------------	-----------------

**NOTICE:** Installation of automatic or manual compression releases on large displacement engines is highly recommended.

**NOTICE:** Installation of a California performance kit onto a 49-state model motorcycle or a 49-state performance kit onto a California model motorcycle will void manufacturers warranty, as it will not result in a street legal configuration.

When installed by an authorized Harley-Davidson® Dealer at the time of vehicle delivery, these kits do not impact the vehicle's limited warranty.

Twin Cam 96 Stock vs. 103CI Stage II Kit

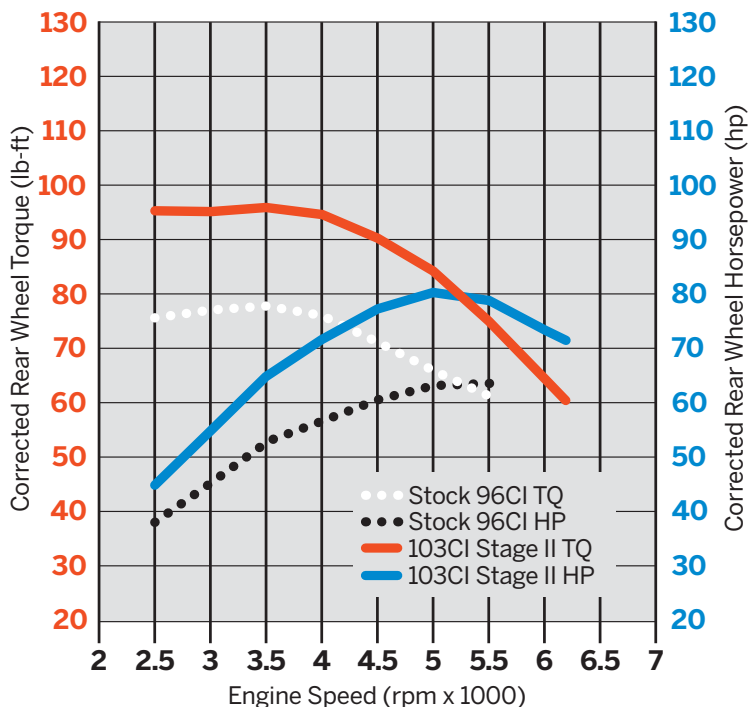

SCREAMIN' EAGLE BIG BORE STAGE II KIT FOR EFI MODELS – 103 CUBIC INCHES

Notice: The prices appearing in this catalog are the manufacturer's suggested retail prices. Actual retail prices may vary.

SCREAMIN' EAGLE



# 514 SCREAMIN' EAGLE®

## Twin Cam Stage Kits

### SCREAMIN' EAGLE® STREET PERFORMANCE BIG BORE STAGE 4 KIT – 103 CUBIC INCHES

This Street Performance kit provides the maximum horsepower output for a legal 103 Kit that will maintain the factory warranty. This kit includes Screamin' Eagle® CNC Ported Factory Cylinder Heads, 58mm ETC throttle body, SE-259E cams, 10.5 to 1 compression pistons, Perfect-Fit pushrods, Screamin' Eagle clutch spring and all required engine gaskets. This Street Performance Kit produces 103 hp and 110 lbs-ft of torque. All EFI-equipped models require ECM calibration\* (priced separately).

\*Recalibration is required for proper installation and will allow engine to rev to 6200 RPM. See Dealer for details. Labor cost is not included.

**92500011** Black Highlighted. **\$1,995.95**  
Fits 50-state '10-later Touring models (except '14-later models with Twin-Cooled™ engines) equipped with a Twin Cam 103™ engine. Fits 49-state '10-'11 Touring models equipped with a Twin Cam 96™ engine with separate purchase of Screamin' Eagle 3-7/8" Big Bore Cylinder Kit. '10 FLHX and FLTRX requires dual exhaust. Does not fit Trike models.

**92500019** Black Highlighted. **\$1,995.95**  
Fits '14-later FLHTCU, FLHTCUL, FLHTK and FLHTKL models with Twin-Cooled engines. Does not fit Trike models.

\*Recalibration is required for proper installation and will allow engine to rev to 6200 RPM. See Dealer for details. Labor cost is not included.

**NOTICE:** Installation of automatic or manual compression releases on large displacement engines is highly recommended.

When installed by an authorized Harley-Davidson® Dealer at the time of vehicle delivery, these kits do not impact the vehicle's limited warranty.



**Screamin' Eagle® Street Performance, Air-Cooled Stage 4 Kit – 103 Cubic Inches**

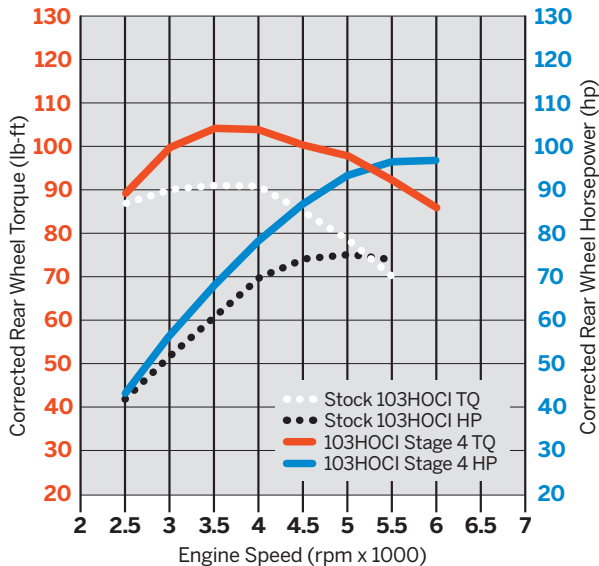

**Screamin' Eagle® Street Performance, Twin-Cooled™ Stage 4 Kit – 103 Cubic Inches**

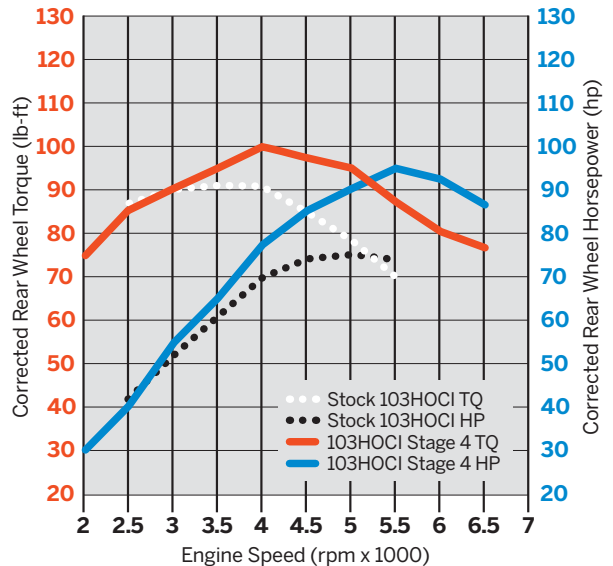

### SCREAMIN' EAGLE STREET PERFORMANCE STAGE 4 KIT – 103 CUBIC INCHES

Notice: The prices appearing in this catalog are the manufacturer's suggested retail prices. Actual retail prices may vary.

# SCREAMIN' EAGLE® 515

Twin Cam Stage Kits



## SCREAMIN' EAGLE® 110 CUBIC INCH STAGE I KIT FOR EFI MODELS\*

Bring your Twin Cam motorcycle up to the same displacement and power output as the CVO™ Screamin' Eagle® models – a gigantic 1800cc's. This street legal kit combines all the proven components of the CVO Screamin' Eagle models – the 4" Big-Bore forged pistons and cylinders, SE-255 camshafts and cylinder heads with automatic compression release. The Screamin' Eagle cylinder heads and forged piston combination offers a 9.3:1 compression ratio for easy starting. The cylinder heads also prominently feature the "Screamin' Eagle 110 medallion. Kit includes all required gaskets (except primary cover and transmission interface gasket) and hardware to complete the installation. Installation requires case boring. Professional installation recommended. Separate purchase of cam spacers is recommended. Requires separate purchase of appropriate Automatic Compression Release Wiring Harness. All EFI-equipped models require ECM calibration\* (priced separately).

\*Recalibration is required for proper installation and will allow engine to rev to 6200 RPM. See Dealer for details. Labor cost is not included.

### 27501-10A Black Highlighted. **\$1,998.95**

Fits 50-state '10-later Touring models (except '14-later models with Twin-Cooled™ engines). Kit includes CVO Air Cleaner Backplate. '10 FLHX and FLTRX models require separate purchase of 2-into-2 Head Pipe Kit and Mufflers. '11-later Touring models require installation of CVO Mufflers P/N 64768-09A and 64769-09A or Fat Shotz Muffler Kit P/N 80847-10 (sold separately). Does not fit Trike models.

### 92500020 **\$1,998.95**

Fits 50-state '14-later FLHTCU, FLHTCUL, FLHTK and FLHTKL models with Twin-Cooled engines.

### 27508-11 Black Highlighted. **\$1,889.95**

Fits '11-later Softail® models (except FLS, FLSTN and FLSTSB). Requires separate purchase of Screamin' Eagle high flow air cleaner and ACR Harness P/N 70623-11.

### 27505-10A Black Highlighted. **\$1,889.95**

Fits 50-state '11-later Dyna® models equipped with Shorty Dual Exhaust. Installation requires separate purchase of Muffler P/N 64895-10 (Qty. 2). Fits 50-state '10-later FXDF and FXDWG models. Requires separate purchase of Mufflers P/N 65884-09 and 65886-09. Kit includes chrome Heavy Breather Air Cleaner Kit.

### 29866-07B Black Highlighted. **\$1,995.95**

Fits '07-'13 HDI Touring models, '07-'09 HDI Dyna models and '07-'09 HDI FLSTF and '07 HDI FXSTD Softail models. Street legal on HDI-configured models when installed with Original Equipment air cleaner and exhaust. '11-'13 later Touring models require separate purchase of Ventilator Air Cleaner and CVO mufflers P/N 64768-09A and 64769-09A.

When installed by an authorized Harley-Davidson® Dealer at the time of vehicle delivery, these kits do not impact the vehicle's limited warranty.

Twin Cam 96™ Stock vs. 110CI Stage I Kit

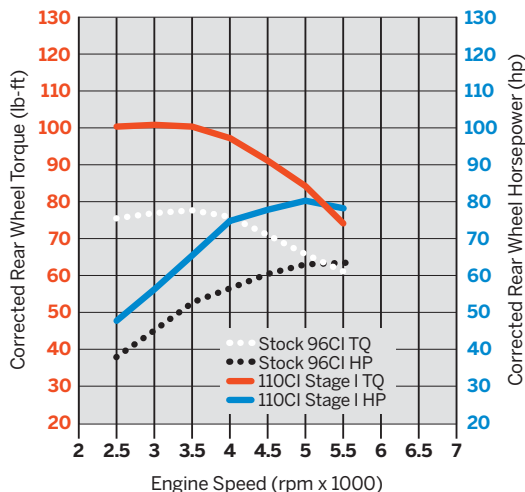

Twin Cam 103HO Stock vs. 110CI Stage I Kit

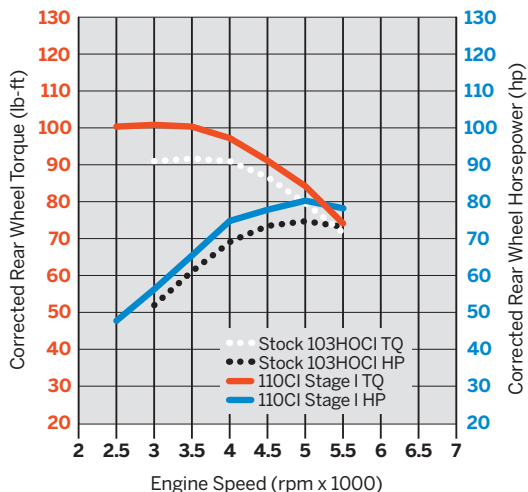

## SCREAMIN' EAGLE 110 CUBIC INCH STAGE I KIT FOR EFI MODELS

Notice: The prices appearing in this catalog are the manufacturer's suggested retail prices. Actual retail prices may vary.

SCREAMIN' EAGLE



# 516 SCREAMIN' EAGLE®

## Performance Cams

### CHOOSING CAMSHAFTS

Camshafts are a fundamental ingredient in the performance recipe, because they control the timing and duration of all major engine events. They are the primary means by which you can tune your engine's horsepower and torque output. Every cam has unique lift and overlap performance characteristics, which means you need to select cams based on exactly the kind of power you're looking for.

While hot cams, higher-flowing cylinder heads and a free-flowing exhaust system will move the peaks higher up the rpm band, conservative cams may feel stronger to a street rider because the maximum torque occurs at lower rpm. The experts at your Harley-Davidson® dealer have the knowledge, skill and experience to recommend the optimum cam specifications for your riding demands.

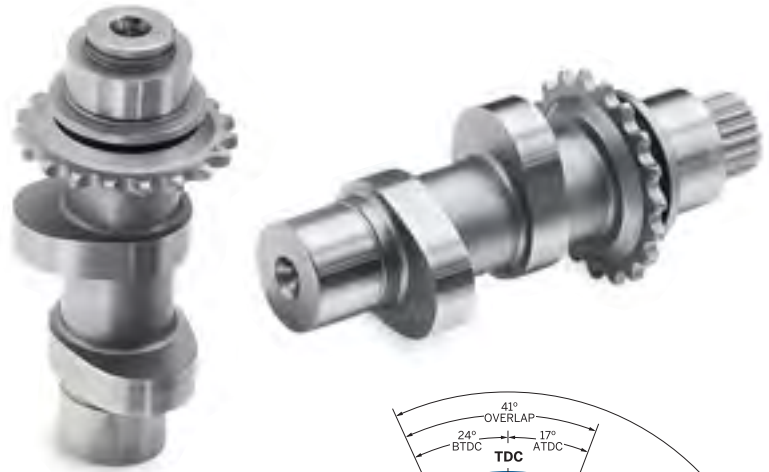

### SCREAMIN' EAGLE® TWIN CAM PERFORMANCE CAMS

Kits include front and rear cams. Splined rear cam is included for exceptional load handling capability. Gaskets and bearings not included. Dealer installation is recommended and special tools are required for proper installation. All EFI models require ECM calibration.

NOTE: Separate purchase of Cam Spacer Kit P/N 25928-06 is recommended for '06-later Dyna® and '07-later Softail® and Touring models. These kits contain five different spacers to achieve proper sprocket alignment. Individual spacers can be purchased separately.

#### SE-204 Cam Kit

This midrange torque bolt-in cam produces peak horsepower around 5800 RPM and installation does not require any headwork or performance valve springs. Should be used in conjunction with open intake and exhaust.

**25464-06** **\$329.95**

Street legal on '11-'13 103CI Touring and Trike models equipped with Fatshotz Mufflers P/N 80847-10.

#### SE-254E Cam Kit

This cam provides great low end torque along with good midrange. A good "all-around" cam, the SE-254E is a good match for a light Touring bike – Road King®, Street Glide® or Road Glide® Custom – when the aggressive rider desires a little more top-end horsepower. In a 0-60 sprint or .25 mile drag race, the SE-254E-equipped model would pull ahead of an identical model with an SE-255 cam.

**25503-10** **\$329.95**

Street legal on '11-'13 103CI Touring and Trike models.

#### SE-255 Cam Kit

The ultimate in torque cams, this cam offers substantial increase in low end torque for engines up to 110 cubic inches with compression ratios up to 10 to 1. The low end torque increases are great for heavy bikes or for the person who routinely shifts below 4500 RPM and wants the power available to pass without downshifting. The cam still makes peak power above 5000 RPM so people with lighter bikes will enjoy the torque increases without feeling like the bike runs out of air at higher engine speeds.

**25638-07** **\$329.95**

Street legal on '09-'13 Dyna, Softail, Touring and Trike models with 103CI and 110CI engines.

#### SE-259E Cam Kit

Developed specifically for throttle body EFI systems, this cam has a modern lobe design that allows for higher valve lifts for a given duration. A high-lift version of the SE-211 camshaft, this cam works great with 103 cubic inch and larger engines with free-flowing intake and exhaust. It can be used with stock heads (updated with race springs) and high-compression pistons for even more torque than a SE-211 cam or can be coupled with any of the performance heads to realize the full power potential.

**25482-10** **\$329.95**

Street legal on '11-later 103CI and 110CI Touring and Trike models.

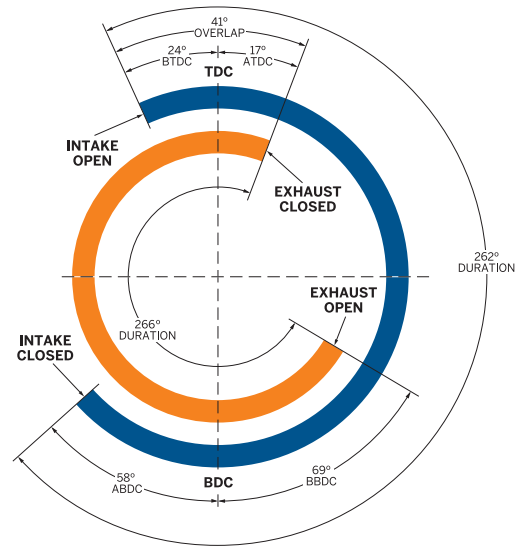

### Valve Timing Events (SE-266E shown)

**TDC** = Top Dead Center (piston at very top of cylinder)

**ATDC** = After Top Dead Center

**BTDC** = Before Top Dead Center

**BDC** = Bottom Dead Center (piston at very bottom of cylinder)

**ABDC** = After Bottom Dead Center

**BBDC** = Before Bottom Dead Center

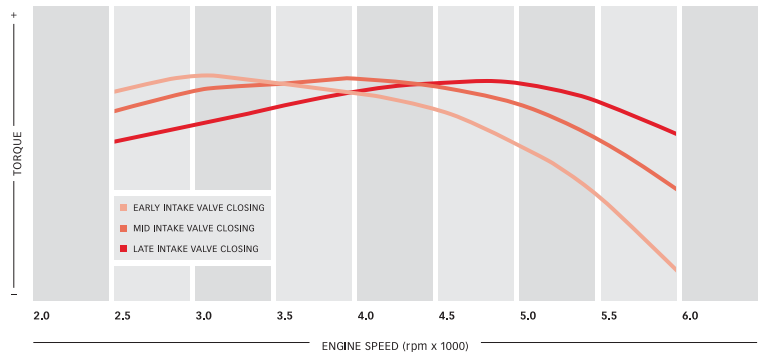

### SELECTING A CAMSHAFT BY THE NUMBERS

The intake closing point relative to bottom center listed in the table on page 517 can be used as a general indicator for the shape of the torque curve. Earlier intake closing values will result in higher torque at low engine speeds (along with lower horsepower at higher engine speeds). Later intake values will result in higher horsepower at high engine speeds (along with lower torque at low engine speeds).

**Intake Closing**  
(degrees ABDC)

**Less than 30°** Early intake closing indicates a low-speed torque cam.

**30° – 50°** Medium intake closing indicates a midrange torque cam.

**Greater than 50°** Late intake closing indicates a high-speed power cam.

Notice: The prices appearing in this catalog are the manufacturer's suggested retail prices. Actual retail prices may vary.

**CAM COMPARISON CHART**  
**TWIN CAM 103™ STOCK VS. 103 WITH SCREAMIN' EAGLE® AIR CLEANER, CAM AND STREET PERFORMANCE MUFFLERS**

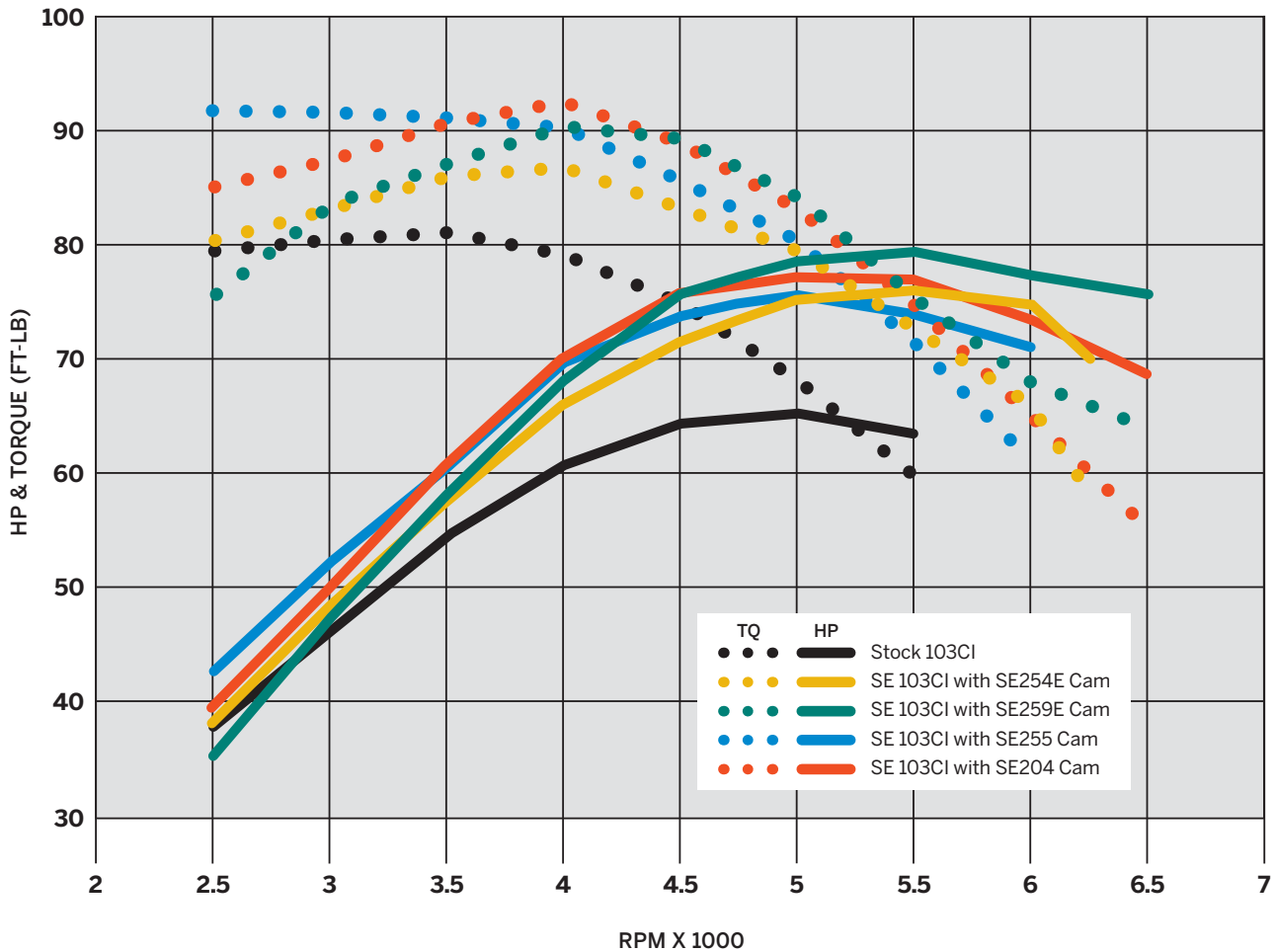

**SCREAMIN' EAGLE TWIN CAM PERFORMANCE CAM SPECS**

Description	Part Number	Lift @ Valve Intake/Exhaust	Duration @.053 Intake/Exhaust	Timing @.053 Lift Open/Close	TDC Lift @ Valve Intake/Exhaust
<b>SE-204</b>	<b>25464-06</b>	.508" / .508"	236° / 240°	Intake: 22° BTDC / 34° ABDC Exhaust: 52° BBDC / 08° ATDC	0.208" / .129"
<b>SE-254E</b>	<b>25503-10</b>	.535" / .536"	224° / 234°	Intake: 01° ATDC / 43° ABDC Exhaust: 50° BBDC / 04° ATDC	0.094" / .102"
<b>SE-255</b>	<b>25638-07</b>	.556" / .556"	211° / 235°	Intake: 06° BTDC / 25° ABDC Exhaust: 48° BBDC / 07° ATDC	0.130" / .116"
<b>SE-259E</b>	<b>25482-10</b>	.579" / .579"	246° / 250°	Intake: 19° BTDC / 47° ABDC Exhaust: 58° BBDC / 12° ATDC	0.182" / .155"
MY14 Stock HO-103	See Service manual for specific P/N	.511" / .511"	212° / 233°	Intake: 02° BTDC / 30° ABDC Exhaust: 43° BBDC / 10° ATDC	N/A

Theoretical based on rocker arm ratio of 1.65. Valve train components, operation temperature and tolerance stack-up will affect actual lifts.

NOTE: Separate purchase of Cam Spacer Kit P/N 25928-06 is recommended for '06-later Dyna® models and '07-later Softail® and Touring models. These kits contain five different spacers to achieve proper sprocket alignment. Individual spacers can be purchased separately.



# 518 SCREAMIN' EAGLE®

## Engine Components

### A. SCREAMIN' EAGLE® BILLET CAM SUPPORT PLATE WITH HIGH-VOLUME OIL PUMP

A great upgrade for any performance motor. The Billet Cam Support Plate is manufactured from billet aluminum with pressed-in bronze bushings and is pre-assembled with the crankshaft bushing and oil pressure relief valve. Aluminum is specified at 6061 billet plate, heat-treated to T6 specifications with a surface-hardened anodized finish to provide superior strength, rigidity and durability. CNC-precision machining ensures precise dimensions and constant material thickness across the plate, enabling perfect alignment of cams and chains. Cam bushings are made from 660 bronze materials to provide enhanced wear resistance and to stand up to increased loads from the high lift cams common in large displacement motors. The improved Screamin' Eagle® high-flow oil pump provides higher pressure when the oil is hot to keep pressure drops to a minimum and increases the oil supply by 16% and the scavenging by 29% over the '06-later Original Equipment oil pump.

**25282-11** **\$429.95**

Fits '06-later Dyna® and '07-later Softail®, Touring and Trike models. Installation requires separate purchase of Cam Service Kit P/N 17045-99D and Drive Gear Retention Kit P/N 25566-06.

### B. SCREAMIN' EAGLE HYDRAULIC CAM CHAIN TENSIONER AND HIGH-FLOW OIL PUMP UPGRADE KIT

This kit updates the cam chain tensioner of your Twin Cam 88® engine to the latest design, as featured on the Twin Cam 96™ engine. The billet cam support plate has been designed to allow the installation of the Twin Cam 96 hydraulic cam chain tensioner to Twin Cam 88-equipped models. These Hydraulic Cam Chain Tensioners will significantly outlast the spring loaded tensioners and are an ideal addition to an engine modified for improved performance. In addition, '02-'06 models utilize a Twin Cam 96 single row front roller chain and sprocket (included in kit). '99-'01 models use Original Equipment front silent chain and sprocket to retain the cam position sensor function. The kit includes an improved Screamin' Eagle High-Flow Oil Pump that provides increased oil pressure at high-operating temperatures. This kit increases the oil supply by 23% and scavenging by 50% when compared to the '99-'05 Original Equipment oil pump and reduces operating temperature of bearings to improve bearing life.

**25284-11** **\$499.95**

Fits '99-'05 Dyna models, '00-'06 Softail models and '99-'06 Touring models. Installation requires separate purchase of Spacer Kit P/N 25285-08, Cam Service Kit P/N 17045-99D and Drive Gear Retention Kit P/N 25566-06.

### C. SCREAMIN' EAGLE HIGH-PERFORMANCE INNER CAM BEARINGS

High-performance Inner Cam Bearings are a smart upgrade when installing high-lift cams in a race bike. These bearings provide increased load capacity and extend the engine life in extreme racing conditions. Kit includes two bearings required to complete one Twin Cam engine.

**24017-10** **\$19.95**

Fits '99-'05 Dyna, '00-'06 Softail and '99-'06 Touring models.

**24018-10** **\$19.95**

Fits '06-later Dyna and '07-later Softail and Touring models.

**Also available:** (not shown):

#### SCREAMIN' EAGLE EVOLUTION® 1340 INNER CAM BEARING

Kit includes single cam bearing.

**9058A** Fits Evolution® 1340 models. **\$12.95**



A. SCREAMIN' EAGLE BILLET CAM SUPPORT PLATE WITH HIGH-VOLUME OIL PUMP



B. SCREAMIN' EAGLE HYDRAULIC CAM CHAIN TENSIONER AND HIGH-FLOW OIL PUMP UPGRADE KIT



HIGH VOLUME OIL PUMP COMPARISON



C. SCREAMIN' EAGLE HIGH-PERFORMANCE INNER CAM BEARINGS



# SCREAMIN' EAGLE® 519

Engine Components

## D. SCREAMIN' EAGLE® PREMIUM TAPERED QUICK-INSTALL ADJUSTABLE PUSHRODS

These premium pushrods are tapered for enhanced clearance at the cylinder head, allowing the use of higher lift cams. The one-piece chrome moly tube adds rigidity and durability and the threaded adjustment feature provides easy cam installation without removing the cylinder heads or rocker boxes. To simplify adjustment, the tube features six flats, with one flat marked with a large dot for tracking the adjustment. The threaded rod features 4 flats to reduce wrench swing. Each pushrod features the Screamin' Eagle logo and is marked for "Intake" or "Exhaust." Kit includes 4 pushrods and required pushrod tubes.

Fits '99-later Twin Cam-equipped models.

<b>17900032</b>	With Gloss Black Covers.	<b>\$189.95</b>
<b>18404-08</b>	With Chrome Covers.	<b>\$184.95</b>

## E. SCREAMIN' EAGLE QUICK-INSTALL PUSHROD KIT FOR TWIN CAM-EQUIPPED MODELS

These pushrods have been designed to allow for easier installation, adjustment and improved durability. This unique Screamin' Eagle design allows for installation of camshafts in the Twin Cam without the removal of the heads or rocker boxes. This design is also a great performer, constructed of stiff chrome moly tubing and thread-rolled adjusters. Kit includes required pushrod tubes and clips for adjustment of pushrods.

<b>17997-99A</b>		<b>\$165.95</b>
------------------	--	-----------------

Fits '99-later Twin Cam-equipped models.

## F. PUSHROD COVER KIT – GLOSS BLACK

Complete the Dark Custom look. These covers replace existing chrome covers to give your bike a blacked-out appearance down to the smallest detail. Pushrod covers are finished in a gloss black and include the four bottom cover tubes and the four upper clips. Installation retains the Original Equipment chrome short center tube to create a high-contrast accent. Cover Kit can be installed on engines already equipped with Adjustable Pushrods or can be installed by removing rocker box covers, rocker arms and non-adjustable pushrods. Consult your dealer or service manual for installation.

<b>17900033</b>	Covers Only.	<b>\$64.95</b>
-----------------	--------------	----------------

Fits '99-later Twin Cam-equipped models. Requires prior installation of Adjustable Pushrods or removal of rocker box covers, rocker arms and fixed-length pushrods.

D. SCREAMIN' EAGLE PREMIUM TAPERED QUICK-INSTALL ADJUSTABLE PUSHRODS – GLOSS BLACK COVERS



D. SCREAMIN' EAGLE PREMIUM TAPERED QUICK-INSTALL ADJUSTABLE PUSHRODS – GLOSS BLACK COVERS



D. SCREAMIN' EAGLE PREMIUM TAPERED QUICK-INSTALL ADJUSTABLE PUSHRODS – CHROME COVERS



E. SCREAMIN' EAGLE QUICK-INSTALL PUSHROD KIT FOR TWIN CAM-EQUIPPED MODELS



F. PUSHROD COVER KIT – GLOSS BLACK

Notice: The prices appearing in this catalog are the manufacturer's suggested retail prices. Actual retail prices may vary.



# 520 SCREAMIN' EAGLE®

Engine Components

## A. SCREAMIN' EAGLE® HIGH-CAPACITY TAPPETS

Screamin' Eagle® Tappets feature large high capacity needles in the roller bearing assembly to improve reliability when operating with high lift cams, high pressure valve springs and in high RPM applications. The 25% larger needle bearings increase the dynamic load rating by approximately 20% when compared to the Original Equipment Twin Cam tappets. The unique design delivers superior tappet life in performance applications. Set of 4.

**18572-13** **\$249.95**

Fits '99-later Twin Cam-equipped models and '00-later XL and XR models.

## B. SCREAMIN' EAGLE TAPPETS

These Screamin' Eagle Tappets incorporate a unique axle, roller and bearing design that increases durability and stability of the tappets. Works well in high horsepower/high RPM applications. Set of 4.

**18568-98** **\$259.95**

Fits '84-'99 Evolution® 1340-equipped models and '86-'90 XL models.

## C. SCREAMIN' EAGLE PERFORMANCE VALVE SPRING KIT\*

This performance Beehive-shaped Valve Spring Kit will permit the Sportster® engine to rev to 7000 RPM. The unique ovate wire yields increased performance from a compact spring design. The installed spring pressure is increased to 208 lbs and allows a maximum lift of .575". Complete kit includes springs, upper collars and keepers and lower collars with integral valve seals.

**18013-03A** **\$149.95**

Fits '04-later XL, XR and '05-later Twin Cam-equipped models. Does not fit Screamin' Eagle Performance Heads with .3125" diameter valves.

## D. SCREAMIN' EAGLE ROLLER ROCKER ARMS

Unique roller-tip design increases strength and reduces valve stem side-loading and tip friction. Built to handle cams with up to .700" lift in high RPM application. Set of 4.

**17378-98** **\$469.95**

Fits '84-'99 Evolution 1340-equipped models, '86-later XL and XR models and '99-later Twin Cam-equipped models. (Modification is required on Twin Cam rocker covers.)

## E. SCREAMIN' EAGLE TWIN CAM FORGED ROCKER SUPPORTS

Increased strength rocker supports will handle the increased loads from higher lift cams and higher RPM applications. This product keeps valve train geometry solid. Works with stock or roller rocker arms. Includes required hardware for installation.

**17675-01B** **\$159.95**

Fits '99-later Twin Cam-equipped models.

## F. SCREAMIN' EAGLE BIG BORE HIGH PERFORMANCE HEAD GASKET KIT

This multi-layered head gasket provides improved sealing for 3.875" Big Bore high performance engines. For engines with compression ratios above 10.0:1, Screamin' Eagle High Tensile Cylinder Studs P/N 16505-01 are required. Sold in pairs.

**16101-01** **\$44.95**

Fits '99-later Big Bore (3.875" bore) Twin Cam-equipped models. Does not fit Twin-Cooled™ equipped models.



A. SCREAMIN' EAGLE HIGH-CAPACITY TAPPETS



B. SCREAMIN' EAGLE TAPPETS



C. SCREAMIN' EAGLE PERFORMANCE VALVE SPRING KIT



D. SCREAMIN' EAGLE ROLLER ROCKER ARMS



E. SCREAMIN' EAGLE TWIN CAM FORGED ROCKER SUPPORTS



F. SCREAMIN' EAGLE BIG BORE HIGH PERFORMANCE HEAD GASKET KIT

**\*CAUTION:** Proper valve spring to rocker cover clearance must always be verified during installation of Screamin' Eagle Valve Spring Kits. Failure to have adequate clearance may result in engine damage.

Notice: The prices appearing in this catalog are the manufacturer's suggested retail prices. Actual retail prices may vary.

# SCREAMIN' EAGLE® 521

Engine Components



**G. SCREAMIN' EAGLE LEFTY BEARING**



**H. SCREAMIN' EAGLE TIMKEN BEARING SLEEVE**

## G. SCREAMIN' EAGLE® LEFTY BEARING

When high-performance engine modifications are made, the increased torque is transferred via the crankshaft to the drive system, putting a significantly higher load on the bearing. The Lefty Bearing is case-hardened on the inner and outer race to provide increased load capacity and enhanced durability in high-torque applications. The bearing is installed in the left side of the crankcase and supports the output shaft to the primary drive system.

**24004-03B**

**\$45.95**

Fits '03-later Twin Cam-equipped models.

## H. SCREAMIN' EAGLE TIMKEN® BEARING SLEEVE

Convert a 2003-later Twin Cam model with a factory-installed roller bearing to a Timken® tapered bearing. When used with Screamin' Eagle® Timken Bearing Tool P/N 34823-08 (sold separately), the Bearing Sleeve can be installed without precision machining. Sleeve accepts press-in Timken bearing (sold separately).

**34822-08**

**\$134.95**

Fits '03-later Twin Cam-equipped models. Installation requires separate purchase of model-specific Sprocket Spacer. '03-'05 Dyna® use P/N 24038-99A, '03-'06 Softail® use P/N 24039-01A, '03-'06 Touring use P/N 24008-99 and '06-later Dyna and '07-later Softail, Touring and Trike models use P/N 11887. Requires separate purchase of Tapered Roller Bearing Set P/N 9028.



**I. SCREAMIN' EAGLE HIGH CAPACITY OIL PAN**

## I. SCREAMIN' EAGLE HIGH CAPACITY OIL PAN

Keep your engine running cooler with by increasing your Touring bike's oil capacity. A great addition to a high-performance motor or for the rider that tours in extreme temperature conditions, the Screamin' Eagle cast-aluminum oil pan is designed to increase the oil capacity by 1.5 quarts over the Original Equipment pan. Increased capacity means the oil cycles through the engine less frequently and the oil can remain in the pan for a longer period of time. The cast-in internal baffles manage the flow to the oil pickup and keep the hot oil exposed to the heat-conducting ribbed aluminum sump. Kit includes cast aluminum oil pan and pan gasket.

**24400099**

**\$599.95**

Fits '09-later Touring models. Does not fit with Oil Temperature Gauge – Fairing Mount P/Ns 70900284, 70900283, 70900176, 70900193. Does not fit Trike models.

## J. AUTOMATIC COMPRESSION RELEASE

Automatic Compression Release (ACR) valves reduce the strain of starting your high performance motor by reducing cylinder compression – automatically! The engine is easier to turn over, resulting in less wear on your starter and battery. After start, the ACR valves close to restore full compression. ACR gives you peace of mind and protects your investment. ACR can be installed on stock or Screamin' Eagle Performance cylinder heads for all '07-later Twin Cam-equipped models. Installation requires machining to be performed by a competent machinist using the Screamin' Eagle Automatic Compression Release Fixture Kit P/N 94648-08 (sold separately). Installation requires separate purchase of model-specific ACR Wiring Harness. Sold individually.

**28861-07A**

**\$39.95**

Fits '07-later Twin Cam-equipped models. Can be used with Original Equipment or Screamin' Eagle Cylinder Heads.

## K. SCREAMIN' EAGLE AUTOMATIC COMPRESSION RELEASE WIRING HARNESS

**70623-06**

**\$59.95**

Fits '07-'11 Dyna, '07-'10 Softail and '07 Touring models equipped with Automatic Compression Release Cylinder Heads.

**70623-08**

**\$49.95**

Fits '08-'11 Touring models equipped with Automatic Compression Release Cylinder Heads.

**70623-11**

**\$59.95**

Fits '11 Softail models equipped with Automatic Compression Release Heads.



**J. AUTOMATIC COMPRESSION RELEASE**



**K. AUTOMATIC COMPRESSION RELEASE WIRING HARNESS**

Notice: The prices appearing in this catalog are the manufacturer's suggested retail prices. Actual retail prices may vary.



# 522 SCREAMIN' EAGLE®

Ignition

## A. SCREAMIN' EAGLE® ST PERFORMANCE SPARK PLUG

Screamin' Eagle® ST Spark Plugs feature double platinum coating for superior erosion resistance and extended life. The "V" trimmed ground electrode reduces shrouding of the flame front to promote flame propagation and the fine wire center electrode enhances start ups and ignitability. Screamin' Eagle ST Plugs feature Ribbed Core Technology (RCT) that provides resistance to fouling and are designed with Original Equipment-style noise suppression to prevent electrical interference with radios and CB communication equipment. Works great in racing applications where rich air/fuel conditions are required. Unique style with Screamin' Eagle logo. Sold in pairs.

### High Compression Applications

These plugs are designed for high performance applications involving modifications in high-flow air cleaners, camshafts, exhaust, performance heads, ignition components, higher compression ratios above Original Equipment configurations or engines specific for racing applications.

**32186-10** **\$19.95**

Fits '99-later Twin Cam-equipped models, '86-later XL and XR models and Evolution® 1340 models equipped with Screamin' Eagle Performance Cylinder Heads.

**32188-10** **\$19.95**

Fits '84-'99 Evolution 1340-equipped models, '75-'81 Shovelhead 74 and 80CI and '83-'84 XR1000 models.

### Stock Compression Applications

Designed for modified engines including performance carburetors, high-flow air cleaners, camshafts, exhaust systems and ignition systems in conjunction with stock compression ratios.

**32189-10** **\$19.95**

Fits '84-'99 Evolution 1340-equipped models, '75-'81 Shovelhead 74 and 80CI models.

**32192-10** **\$19.95**

Fits '99-later Twin Cam-equipped models and '86-later Evolution Sportster® 883, 1100 and 1200 models.

## B. SCREAMIN' EAGLE TERMINATED PLUG WIRE KITS – EVOLUTION ENGINES

These custom 8mm terminated plug wire sets are larger in diameter than stock wires and feature silicone plug boots and suppression core so that your electronic ignition is not affected. Use with your stock production coil or the perfect addition when upgrading to one of our Performance Coils.

Fits '97-'98 FLHT, FLHTC, FLHTCU and FLHR models.

**32094-98** Black. **\$14.95**

Fits '82-'99 FXR models.

**32090-98** Black. **\$14.95**

Fits '85-'96 Evolution 1340 FLT, FLHT, FLHR and '82-'93 FLHS models.

**32091-98** Black. **\$14.95**



A. SCREAMIN' EAGLE ST PERFORMANCE SPARK PLUG



B. SCREAMIN' EAGLE TERMINATED PLUG WIRE KIT – EVOLUTION ENGINES

Notice: The prices appearing in this catalog are the manufacturer's suggested retail prices. Actual retail prices may vary.



C. SCREAMIN' EAGLE 10MM PHAT SPARK PLUG WIRES



C. SCREAMIN' EAGLE 10MM PHAT SPARK PLUG WIRES



C. SCREAMIN' EAGLE 10MM PHAT SPARK PLUG WIRES – CUT TO LENGTH

## SCREAMIN' EAGLE® 523

Ignition

### C. SCREAMIN' EAGLE® 10MM PHAT SPARK PLUG WIRES

Fat 10mm plug wires add dimension and style to your ride. Screamin' Eagle® boot design and suppression core wires ensure solid connection and maximum voltage transfer between coil and plugs. "Screamin' Eagle" logo printed along wire to add style.

Fits '09-later Touring and Trike models.

<b>32303-08</b>	Black.	<b>\$24.95</b>
<b>32318-08</b>	Red.	<b>\$24.95</b>
<b>32325-08</b>	Orange.	<b>\$24.95</b>

Fits '99-'08 Touring models.

<b>31932-99B</b>	Black.	<b>\$24.95</b>
<b>31939-99B</b>	Red.	<b>\$24.95</b>
<b>31946-99B</b>	Orange.	<b>\$24.95</b>

Fits '99-later Dyna® models.

<b>31930-99B</b>	Black.	<b>\$24.95</b>
<b>31937-99B</b>	Red.	<b>\$24.95</b>
<b>31944-99B</b>	Orange.	<b>\$24.95</b>

Fits '00-later Softail® models (except FXCW, FXCWC, FXS and FXSB models).

<b>31907-08</b>	Black.	<b>\$24.95</b>
<b>32359-00B</b>	Red.	<b>\$24.95</b>
<b>32360-00B</b>	Orange.	<b>\$24.95</b>

Fits '08-later FXCW, FXCWC, FXS and FXSB models.

<b>31965-08</b>	Black.	<b>\$24.95</b>
<b>31967-08</b>	Red.	<b>\$24.95</b>

Fits '91-'98 Dyna, '85-'99 Softail and '80-'84 Touring models.

<b>32093-98A</b>	Black.	<b>\$24.95</b>
<b>31964-89B</b>	Orange.	<b>\$24.95</b>

Fits '07-later XL models.

<b>31901-08</b>	Black.	<b>\$24.95</b>
<b>31902-08</b>	Orange.	<b>\$24.95</b>

Fits '04-'06 XL models.

<b>31958-04A</b>	Black.	<b>\$24.95</b>
<b>31956-04A</b>	Orange.	<b>\$24.95</b>

Fits '86-'03 XL models.

<b>32092-98A</b>	Black.	<b>\$24.95</b>
<b>31963-89A</b>	Orange.	<b>\$24.95</b>

Multi-Fit – Cut to length.

<b>32095-98A</b>	Black.	<b>\$24.95</b>
<b>31987-85B</b>	Yellow.	<b>\$24.95</b>

Notice: The prices appearing in this catalog are the manufacturer's suggested retail prices. Actual retail prices may vary.



## 524 SCREAMIN' EAGLE®

Clutch & Drivetrain

### A. SCREAMIN' EAGLE® TWIN CAM PERFORMANCE ASSIST AND SLIP (A&S) CLUTCH KIT

Developed for the high-thrust 110CI engine featured as Original Equipment on '14-later Screamin' Eagle® CVO™ models, this A&S clutch provides significantly increased torque-handling capacity (115lb/ft). Clutch is designed to improve engagement grip and provides minor slippage during downshifting to reduce shock to the power train. Reduces hand lever pull effort by over 1 pound. Complete kit features improved clutch plates for enhanced wear resistance and is the perfect addition when installing a high-output Screamin' Eagle Stage Kit.

**37000026** **\$389.95**

Fits '14-later Touring and Trike models with hydraulic clutch actuator.

### B. SCREAMIN' EAGLE VARIABLE PRESSURE CLUTCH

Get more performance from the Original Equipment clutch. The Screamin' Eagle Variable Pressure Clutch is designed to help put the added power from a Screamin' Eagle Stage Kit to the pavement. This bolt-on kit harnesses the centrifugal force of spinning weights to increase the clutch capacity as engine speed increases. The mechanism applies increasing pressure to the stock clutch pressure plate as RPM rises. The result: High torque-handling capabilities without increasing clutch lever effort at idle. The Variable Pressure Clutch also provides smoother clutch disengagement at lower speed. Kit fits behind most stock derby covers with no modifications. See installation manual for additional accessory derby cover fitment information.

To match the performance demands of your engine, team the Variable Pressure Clutch with your choice of clutch diaphragm springs. We recommend the higher capacity Screamin' Eagle Diaphragm Spring P/N 37951-98 for major performance upgrades.

	Lever Effort	Torque Capacity
Original Equipment Spring	Same as stock	120 ft-lbs
SE Spring P/N 37951-98	35% greater than stock	153 ft-lbs

**37000121** **\$289.95**

Fits '99-later Evolution® 1340 and Twin Cam-equipped models. Derby Covers P/N 25001-03, 25441-04A, 25770-99, 25331-10, 25339-10, 25700250 and 25700062 require Spacer Kit P/N 37000123. Does not fit Derby Covers P/N 25347-02 or 25345-01. Will not fit '13-later CVO Touring models with hydraulic actuated clutch or '14-later Touring and Trike models equipped with Screamin' Eagle A&S Clutch Kit P/N 37000026. Will not fit '15-later FLHTCUL or FLHTKL models or '07-later Touring or Trike models equipped with Narrow-Profile Outer Primary Cover P/N 25700385 or 25700438.



A. SCREAMIN' EAGLE TWIN CAM PERFORMANCE ASSIST AND SLIP CLUTCH KIT



B. SCREAMIN' EAGLE VARIABLE PRESSURE CLUTCH

Notice: The prices appearing in this catalog are the manufacturer's suggested retail prices. Actual retail prices may vary.

# SCREAMIN' EAGLE® 525

Clutch & Drivetrain



**C. SCREAMIN' EAGLE TWIN CAM PERFORMANCE RACE CLUTCH HUB KIT**



**D. SCREAMIN' EAGLE RACE CLUTCH KIT**



**E. SCREAMIN' EAGLE PERFORMANCE CLUTCH FRICTION DISC KIT**



**F. HEAVY DUTY CLUTCH SPRING FOR STOCK CLUTCH**



**G. SCREAMIN' EAGLE PERFORMANCE CLUTCH KIT**



**H. SCREAMIN' EAGLE PERFORMANCE SLIPPER CLUTCH FOR VRSC MODELS**

## **C. SCREAMIN' EAGLE® TWIN CAM PERFORMANCE RACE CLUTCH HUB KIT**

Innovative new clutch hub kit offers improved clutch performance and is perfect for large displacement applications. Will support engines producing up to 160 ft-lbs of torque. Kit includes the hub, pressure plate and clutch springs and can be used with stock friction discs and spacers or Screamin' Eagle® Friction Disc Kit P/N 37980-10. (Does not include clutch friction plates.)

**37976-08A \$269.95**

Fits '07-later Twin Cam-equipped models. Will not fit '13-later CVO™ Touring models with hydraulic actuated clutch or '14-later Touring models equipped with Screamin' Eagle A&S Clutch Kit P/N 37000026.

## **D. SCREAMIN' EAGLE RACE CLUTCH KIT**

This clutch has an innovative design that features new long life friction plates and 6 individual coil springs to adjust your clutch to your specific needs. Designed to handle up to 160 ft-lbs of torque at the crank.

**37970-03A \$399.95**

Fits '90-'99 Evolution® 1340-equipped models and '99-'06 Softail® and Touring and '99-'05 Dyna® models.

NOTE: '90-'97 Evolution 1340-equipped models require Clutch Shell P/N 37707-98A and Rod Adjuster Screw P/N 37090-98A. '90-'93 Evolution 1340-equipped models also require starter P/N 31553-94B.

## **E. SCREAMIN' EAGLE PERFORMANCE CLUTCH FRICTION DISC KIT**

Newly-developed friction material delivers longer life than Original Equipment friction discs. Kit includes new precision-machined flat steel plates. This Friction Disc Kit is a perfect match for the Screamin' Eagle Twin Cam Performance Race Clutch Hub Kit P/N 37976-08.

**37980-10 \$179.95**

Fits '99-later Twin Cam-equipped models and '98-'99 Evolution 1340-equipped models. Will not fit '13-later CVO Touring models with hydraulic actuated clutch or '14-later Touring models equipped with Screamin' Eagle A&S Clutch Kit P/N 37000026.

## **F. HEAVY DUTY CLUTCH SPRING FOR STOCK CLUTCH**

**37951-98 \$34.95**

Fits '99-later Twin Cam-equipped models and '98-'99 Evolution 1340-equipped models. Will not fit '13-later CVO Touring models with hydraulic actuated clutch or '14-later Touring models equipped with Screamin' Eagle A&S Clutch Kit P/N 37000026.

## **G. SCREAMIN' EAGLE PERFORMANCE CLUTCH KIT**

Performance Clutch Kit converts the 8-plate clutch to a 9-plate design. The surface area is increased by 13% and the spring rate is increased by 10% for a combination that can handle over 115 ft-lbs of torque at the crank, a 23% increase over the stock-rated capacity. Kit includes Kevlar® fiber-based friction discs and performance clutch spring.

**38002-04 \$199.95**

Fits '91-later XL and '94-'97 Evolution 1340-equipped models.

## **H. SCREAMIN' EAGLE PERFORMANCE SLIPPER CLUTCH FOR VRSC™ MODELS**

This clutch offers reduced lever effort and improved performance. The unique "slip and assist" ramp system opens the two halves of the clutch hub slightly during high loads to the drivetrain, allowing a moderate slip that reduces shock to the drivetrain during rapid downshifting. The resulting reduction in wheel hop allows maximum contact between the tire and the road in wet or slippery conditions. Clutch lever effort is also reduced by 20% in 1130cc and 30% on 1250cc applications.

**37938-08KA \$239.95**

Fits '02-'07 VRSC™ models.

Notice: The prices appearing in this catalog are the manufacturer's suggested retail prices. Actual retail prices may vary.



# 526 SCREAMIN' EAGLE®

Clutch & Drivetrain

## A. SCREAMIN' EAGLE® BIG TWIN COMPENSATOR

This premium compensator has been engineered with heavier springs and increased travel to support the high torque output associated with high compression race and large displacement engines. Designed to outperform the Original Equipment compensator, this unit helps protect the engine and driveline components during harsh drag race launches. Compensator features improved oil passages, oil deflectors and a needle bearing thrust washer that improves the overall operation of these components.

**42200064A** **\$299.95**

Fits '12-'13 Dyna®, '12-'13 Softail® (except FXCW, FXCWC, FXSTSSE3, FXSB and FXSBSE) and '12-'13 Touring and Trike models. Original Equipment on '14-later Dyna, Softail and Touring models. Requires separate purchase of Installation Adhesive Kit P/N 11100088.

**40100061** **\$409.95**

Fits '06-'11 Dyna, '07-'11 Softail (except FXCW, FXCWC), '07-'10 Touring, and '07-'09 CVO (except FXSTSSE3) models. Does not fit Trike. Requires separate purchase of Installation Adhesive Kit P/N 11100088. Kit includes Rotor Assembly P/N 30041-08. Installation on '06 Dyna models require separate purchase of '07-style stator.

**42200095A** **\$299.95**

Fits '08-'12 FXCWC and FXSTSSE3 models and '13-later FXSB models. If P/N 40274-08A has been installed previously, the rotor shell, P/N 30041-08A is not required.

## B. SCREAMIN' EAGLE MANUAL PRIMARY CHAIN TENSION ADJUSTER

The Screamin' Eagle® Manual Primary Chain Tension Adjuster is a real benefit in those aggressive racing situations where frequent drag racing starts and high rpm speed shifting are part of the riding experience. Ideal for bikes equipped with big displacement high performance (100hp+) engines that are regularly used for track-day drag racing; this Screamin' Eagle Tension Adjuster permits manual selection of primary chain tension. A direct replacement for the Original Equipment automatic version, this anodized billet aluminum adjuster allows you to fine-tune the settings and lock the position when the freeplay is properly set. The manual adjustment locks the chain tension in place to prevent the chain from adjusting during severe shifting. Kit includes required mounting hardware.

**36500020** **\$149.95**

Fits '06-later Dyna and '07-later Softail, Touring and Trike models. Requires separate purchase of model-specific primary gaskets and seals.

## C. AUTOMATIC PRIMARY CHAIN TENSION ADJUSTER

Original Equipment on '06-later Dyna and '07-later Softail and Touring models, this Automatic Primary Chain Adjuster eliminates the need to manually adjust the primary chain tension at traditional service intervals.

**40063-05B** **\$109.95**

Fits '85-'06 Evolution® 1340 (except '85-'88 Softail) and Twin Cam powertrain. Requires separate purchase of model-specific primary gasket and seals.

## D. TWIN CAM TRANSMISSIONS – SOFTAIL

**Six-Speed Cruise Drive® Transmission.**

**33006-14** Black and Chrome. **\$1,827.00**

Fits '10-later Softail models (except CVO™, FXCW, FXCWC and FXSB). Includes clutch cable for FLSTC models.

## E. TWIN CAM TRANSMISSION – TOURING

**Six-Speed Cruise Drive Transmission.**

**32228-15** Black and Chrome. **\$1,827.00**

Fits '10-later Touring models (except CVO and models with hydraulic activated clutch). Includes clutch cable.

NEW



A. SCREAMIN' EAGLE BIG TWIN COMPENSATOR



B. SCREAMIN' EAGLE MANUAL PRIMARY CHAIN TENSION ADJUSTER



C. AUTOMATIC PRIMARY CHAIN TENSION ADJUSTER



D. TWIN CAM TRANSMISSION – SOFTAIL, BLACK AND CHROME



E. TWIN CAM TRANSMISSION – TOURING, BLACK AND CHROME

Notice: The prices appearing in this catalog are the manufacturer's suggested retail prices. Actual retail prices may vary.

# SCREAMIN' EAGLE® 527

Transmission

## F. SCREAMIN' EAGLE® 6-SPEED TRANSMISSION AND GEAR SET

Designed from the ground up, the Screamin' Eagle® transmission incorporates many of the best Original Equipment features, like late-style shifting mechanism and a newly designed "shift ring" system to make this the smoothest shifting Harley-Davidson® transmission available. The "shift ring" system is similar to the system used in the VRSC™ transmission and it slides on the shafts to mate into the gears. This eliminates sliding heavy gears to accomplish the shift and results in smooth, precise and light effort shifting. Sixth gear is a true overdrive, at a .89:1 ratio and the first five gears mimic today's proven 5-speed ratios. The overdrive feature allows you to run a lower engine RPM in sixth gear, at any given road speed. Lower RPM can result in lower vibration, longer engine life and smoother cruising. The Screamin' Eagle 6-Speed Transmission is available as a complete transmission or as a replacement gear set and can be matched with hydraulic or cable-operated clutch controls.

Screamin' Eagle 6-Speed Transmissions feature forged chrome "trap door," forged shifter forks and forged and precisely ground gears. No speedometer or exhaust mount modifications are required. Complete transmissions are ready to install into the chassis and the 6-Speed Gear Set Kits are designed to replace the stock gear set without removing the transmission. Gear Set Kits require slight modification (template included) to the Original Equipment transmission case and include all necessary installation hardware.

### COMPLETE TRANSMISSION

Fits '01-'05 Dyna® models. Requires separate purchase of appropriate Side Cover Release Kit.

**33040-03A** Black and Chrome. **\$2,799.95**

Fits '00-'06 Softail® models. Requires separate purchase of appropriate Side Cover Release Kit.

**33045-03A** Black and Chrome. **\$2,799.95**

Fits '90-'99 Softail models. Includes Cable Side Cover Release Kit.

**33104-03** Black and Chrome. **\$2,799.95**

Fits '02-'06 Touring models. Requires separate purchase of appropriate Side Cover Release Kit.

**33137-04** Black and Chrome. **\$2,799.95**

### GEAR SET

**33100-03A** **\$2,099.95**

Fits '90-'99 Softail and '91-'94 and '96-'00 Dyna models. Requires separate purchase of appropriate Side Cover Release Kit.

**33101-03A** **\$2,099.95**

Fits '90-'00 Touring models. Requires separate purchase of appropriate Side Cover Release Kit.

**33102-03A** **\$2,099.95**

Fits '00-'06 Softail and '01-'06 Touring models. Requires separate purchase of appropriate Side Cover Release Kit.

**33103-03A** **\$2,099.95**

Fits '01-'05 Dyna models. Requires separate purchase of appropriate Side Cover Release Kit.

### Shown with:

#### SCREAMIN' EAGLE TRANSMISSION SIDE COVER FOR 6-SPEED TRANSMISSION

Includes unique side cover and clutch components required for installing a Screamin' Eagle 6-Speed Transmission.

**38753-04A** Hydraulic Clutch. **\$299.95**

Fits '99-'06 Touring, '99-'05 Dyna and '00-'06 Softail models equipped with Screamin' Eagle 6-Speed Transmission and Hydraulic Clutch. NOTE: If installing a Hydraulic Clutch on a previously installed Screamin' Eagle 6-Speed, separate purchase of the Clutch Release Cover Gasket P/N 35148-03 is required.

**38752-04** Cable Clutch. **\$199.95**

Fits '90-'06 Touring, '91-'05 Dyna and '90-'06 Softail models equipped with Screamin' Eagle 6-Speed Transmission and cable-actuated clutch.

Notice: The prices appearing in this catalog are the manufacturer's suggested retail prices. Actual retail prices may vary.

SCREAMIN' EAGLE



The Screamin' Eagle 6-Speed Transmission has been tested and validated using the same rigorous procedures that Original Equipment transmissions are subjected to and is backed by a 12 or 24-month (depending on model year) unlimited mileage warranty when installed at the time of a new bike purchase.

## F. SCREAMIN' EAGLE 6-SPEED TRANSMISSION AND GEAR SET (SHOWN WITH SCREAMIN' EAGLE TRANSMISSION SIDE COVER FOR 6-SPEED TRANSMISSION)



## SCREAMIN' EAGLE® CRATE ENGINE & LONGBLOCK PROGRAM

When the heart of your Harley® motorcycle gets a little tired – we can help wake it up. We offer complete crate motors and short block assemblies for a wide variety of models or we can supply a factory-fresh Twin-Cam LongBlock complete with your original VIN to get you back on the road.



# SCREAMIN' EAGLE® 529

Twin Cam Engines



A. TWIN CAM ENGINE – SOFTAIL, BLACK AND CHROME 110B

## A. TWIN CAM ENGINE

The balanced Twin Cam Engine has brought a whole new ride to the Softail® family. And now, you can get the most technologically advanced, air-cooled, V-Twin engines to refresh your ride. Available in 88CI, 96CI, 103CI and 110CI configurations, these engines are street-legal when installed in the models specified. Manufactured to the latest specifications, these engines are available in a variety of finishes to suit your customizing direction. See your Dealer for details.

NOTE: CVO™ 103B and Twin Cam 88B™ engines now feature factory installed Screamin' Eagle® Hydraulic Cam Chain Tensioner Plate and Oil Pump upgrade kit. This latest cam chain tensioner design will significantly outlast the Original Equipment-style spring tensioners and the upgraded oil pump increases oil flow by 8% and oil scavenging by 22%.

### 1800cc Screamin' Eagle® Twin Cam 110B™

Fits '07-later CVO Softail models. Does not include intake system, timer cover, stator, rotor or compensating sprocket assembly.

**19293-15** Black and Chrome. **\$5,495.00**

### 1690cc Screamin' Eagle Twin Cam 103B™

Fits '06 FLSTFSE2 models. Includes Screamin' Eagle Hydraulic Cam Chain Tensioner and Oil Pump upgrade. Does not include intake system, timer cover, stator, rotor or compensating sprocket assembly.

**19293-06D** Black and Chrome. **\$5,495.00**

**19296-06D** Silver and Chrome. **\$5,495.00**

### 1690cc Twin Cam 103B

Fits '12-later Softail models factory equipped with a Twin Cam 103B engine. Does not include intake system, timer cover, stator, rotor or compensating sprocket assembly.

**19811-15** Black and Chrome. **\$4,795.00**

### 1450cc Twin Cam 88B

Fits '06 Softail models (except '06 FLSTFSE2). Includes Screamin' Eagle Hydraulic Cam Chain Tensioner and Oil Pump upgrade. Does not include intake system, timer cover, stator, rotor or compensating sprocket assembly.

**19258-06D** Silver and Polished. **\$4,195.00**

**19259-06D** Black and Chrome. **\$4,395.00**

### 1800cc Screamin' Eagle Twin Cam 110A

Fits '08-'13 CVO FLHTCUSE, FLHXSE, FLTRXSE, FLTRUSE, '13-'14 CVO FLHRSE and '15-later FLHXSE models. Requires installation of oil cooler and cover kit. Does not include intake system, timer cover, stator, rotor or compensating sprocket assembly.

**19176-15** Black and Chrome. **\$5,195.00**

### 1690cc Twin Cam 103A

Fits '10-'13 FLHTK, FLHTCUTG and FLHXXX and '11-'13 Touring models factory equipped with Twin Cam 103A engine. Does not include intake system, timer cover, stator, rotor or compensating sprocket. Does not fit Twin Cooled equipped models.

**19678-13A** Black and Chrome. **\$4,595.00**

Fits '14-later Touring (except Twin-Cooled™) and '15-later FLRT models. Does not include intake system, timer cover, stator, rotor or compensating sprocket assembly.

**19678-15** Black and Chrome. **\$4,595.00**

### 1690cc Screamin' Eagle Twin Cam 103A

Fits '06 FLHTCUSE models. Includes Screamin' Eagle Hydraulic Cam Chain Tensioner and Oil Pump upgrade. Requires installation of Oil Cooler P/N 62994-04 and Cover Kit P/N 62995-04. Does not include intake system, timer cover, stator, rotor or compensating sprocket assembly.

**19176-06D** Black and Chrome. **\$5,195.00**

**19264-06D** Silver and Chrome. **\$5,195.00**

### 1450cc Twin Cam 88A

Fits '05 Dyna® models. Includes Screamin' Eagle Hydraulic Cam Chain Tensioner and Oil Pump upgrade. Does not include intake system, timer cover, stator, rotor or compensating sprocket assembly.

**19255-05C** Black and Chrome. **\$4,195.00**

**19256-05C** Silver and Polished. **\$3,995.00**

SCREAMIN' EAGLE



A. TWIN CAM ENGINE – DYNA AND TOURING, BLACK AND CHROME 110A

Notice: The prices appearing in this catalog are the manufacturer's suggested retail prices. Actual retail prices may vary.



# 530 SCREAMIN' EAGLE®

Revolution® Engines/Shortblock

## A. REVOLUTION X™ ENGINE

With the launch of the new Harley-Davidson® Street™ motorcycles, the world has been introduced to a new powertrain from Harley-Davidson. This engine is now available from your HD dealer. Available in black, the engine comes complete with clutch system, stator/rotor charging system and transmission. Does not include throttle body or ECM.

**20022-15** XG750 Engine – Black **\$3,795.00**  
Fits '15-later XG750 models.

## B. REVOLUTION® VRSC™ ENGINE

With the launch of the V-Rod® motorcycle in 2002, the world was introduced to a revolutionary new powertrain and now the Revolution engine is available from your Harley-Davidson dealer. Available in gloss black 1250cc configuration as featured as Original Equipment on the 2015 V-Rod models.

**19973-15K** Gloss Black. **\$7,100.00**  
Fits '12-later VRSC™ models. Does not include charging system or induction system.

## C. CRATE ENGINE SHORTBLOCK ASSEMBLY

The perfect starting point for building the engine of your dreams. Engine shortblocks are manufactured and assembled on Harley-Davidson's main engine assembly line for exceptional quality and reliability. Shortblock cases, flywheels, bearings and rods are preassembled and ready for your custom build. Kit includes current spec Original Equipment cam plate, oil pump, cam drive components and the gaskets, seals and most of the hardware required to complete the engine and install it (not all components shown). You select your cylinders, heads, cams, covers and other top-end components. Choose one of the Screamin' Eagle® Stage kits to incorporate reliable performance and pick from our decorative engine covers to customize the look. Shortblock Assemblies are stamped with a new VIN number and include MSO (Manufacturers Statement of Origin). The MSO is for Domestic only. Kits ship directly from the factory within 3-5 days.

**16200070** Black 96CI/103CI. **\$1,695.00**  
Fits '07-later Dyna®, Touring and Trike models (except CVO™).

**16200071** Black 96CI/103CI. **\$1,995.00**  
Fits '07-later Softail® models (except CVO).



A. REVOLUTION X ENGINE



B. REVOLUTION VRSC ENGINE – GLOSS BLACK



C. CRATE ENGINE SHORTBLOCK ASSEMBLY – DYNA AND TOURING



C. CRATE ENGINE SHORTBLOCK ASSEMBLY – SOFTAIL

NOTE: Replacement engines must be re-fitted with emission control devices and systems, appropriate for the vehicle model and model year in order to ensure emissions compliance. Failure to do so constitutes tampering under US EPA guidelines and can lead to substantial fines and penalties.

Legal for use on public roads only when installed in the specified models. Not legal for use on public roads when installed in models other than the ones specified and not eligible for the P&A 24-month warranty when installed in models other than the ones specified. Please see the Parts and Accessories warranty statement and your dealer for more information.



---

## LONGBLOCK

When it comes time to repower your Twin Cam-equipped motorcycle, the first stop should be your local Harley® dealer. They can install a LongBlock replacement engine that is manufactured from 100% new Original Equipment parts and subjected to the same rigorous testing as all Harley engines. Plus, the replacement engine features a one-year factory warranty and your original VIN stamped on the case.



## HARLEY-DAVIDSON® LONGBLOCK PROGRAM

Your engine is the heart and soul of your Harley-Davidson® motorcycle. When the miles start to add up, a Harley-Davidson LongBlock can put the rumble back in your ride simply, quickly, and affordably.

**WHY SHOULD I CONSIDER A LONGBLOCK?** Unlike an engine rebuild from the repair shop down the street, the Harley-Davidson LongBlock is manufactured from 100% new Original Equipment components, and is built to the latest factory specifications. Engine includes upgraded Screamin' Eagle® lefty crankcase bearing, Screamin' Eagle cam bearings and Screamin' Eagle performance tappets to handle higher stress loads and performance upgrades. In addition, '99-'06 LongBlocks are upgraded with late-model hydraulic cam tensioners, high-volume oil pump and billet cam plate. '07-'13 103CI and 110CI engines feature factory-installed Automatic Compression Releases.

**WHAT DOES THE H-D® LONGBLOCK INCLUDE?** The crankcase is pre-assembled with flywheels, connecting rods, bearings, seals, cylinders, pistons, rings, heads, valves, valve springs, tappets and pushrod covers. Also included and ready for Dealer installation are top end rocker arm supports, rocker arms and shafts, pushrods, and breathers. The LongBlock also includes cam support plate, cam plate bearings, cam and timing chain drive, hydraulic tensioners and all required gaskets and new hardware.

**ARE UPGRADES AVAILABLE?\*** You can choose silver or black-highlighted engines to match your styling direction. Bikes originally equipped with Twin Cam 88 engines can upgrade to 95 or 103CI displacement, and Twin Cam 96-equipped models can be repowered with 103 or 110CI engines, based on specific model fitment. Upgrades require model-specific ECM recalibration (sold separately).

**WHAT ELSE DO I NEED?** LongBlock is sold without cam shafts, lower rocker boxes, upper rocker box covers, or cam cover. You have the option to re-install your current cams and covers, or select from a wide assortment of performance and custom engine cover options.

**FAST AND EASY:** Just take your Harley motorcycle to your authorized dealership. They will remove the engine from the frame, ship the left crankcase half to Harley-Davidson, and in a short time, you will have a new LongBlock back, ready for the dealer to reinstall in your bike. Your engine retains its original Vehicle Identification Number (VIN) for easy title exchange and registration.

*\*Displacement upgrades are available for vehicles previously equipped with street compliant big bore kits only.*

**Also available:**

**ENGINE COVER KITS**

Finish your LongBlock engine installation in style. Kit includes 2 upper and lower rocker box covers and matching cam cover.

Fits '01-later Dyna, '01-later Softail and '01-later Touring and Trike models (except '01 EFI Touring).		
92500025	Chrome.	\$399.95
92500026	Gloss Black.	\$299.95
92500027	Wrinkle Black.	\$299.95



**Available to fit:**

**'00-'06 Softail® models.**

16200087	Twin Cam 88 – Black.	\$3,750.00
16200088	Twin Cam 88 – Silver.	\$3,750.00

**'01-'06 EFI Softail models.**

16200093	Twin Cam 95 – Black.*	\$4,150.00
16200094	Twin Cam 95 – Silver.*	\$4,150.00

**'05-'06 EFI Softail models.**

16200097	Twin Cam 103 – Black.*	\$4,695.00
16200098	Twin Cam 103 – Silver.*	\$4,695.00

**'07-'13 Softail models.**

16200101	Twin Cam 96 – Black.	\$3,850.00
16200102	Twin Cam 96 – Silver.	\$3,850.00
16200104	Twin Cam 103 – Black.*	\$4,395.00
16200108	Twin Cam 110 – Black.*	\$4,695.00
16200109	Twin Cam 110 – Granite.*	\$4,695.00

**'99-'05 Dyna® and '99-'06 Touring models.**

16200085	Twin Cam 88 – Black.	\$3,495.00
16200086	Twin Cam 88 – Silver.	\$3,495.00

**'04-'05 EFI Dyna and '99-'06 EFI Touring models.**

16200091	Twin Cam 95 – Black.*	\$3,895.00
16200092	Twin Cam 95 – Silver.*	\$3,895.00

**'03-'06 EFI Touring models.**

16200095	Twin Cam 103 – Black.*	\$4,495.00
16200096	Twin Cam 103 – Silver.*	\$4,495.00

**'06-'13 Dyna and '07-'13 Touring models.**

16200099	Twin Cam 96 – Black.	\$3,595.00
16200100	Twin Cam 96 – Silver.	\$3,595.00

**'07-'13 Dyna and '07-'13 Touring models.**

16200103	Twin Cam 103 – Black.*	\$4,195.00
16200105	Twin Cam 110 – Black.*	\$4,395.00
16200106	Twin Cam 110 – Granite.*	\$4,395.00

# SCREAMIN' EAGLE® 533

LongBlock Program



## LONGBLOCK – '99-'06 MODELS (DYNA/TOURING SHOWN)



## LONGBLOCK – '07-'13 MODELS (DYNA/TOURING SHOWN)



**NOTE:** All fasteners are included but not shown.



GENUINE MOTOR PARTS &amp; ACCESSORIES



2015

## ENGINE TRIM

The jewel of every Harley-Davidson® motorcycle is the V-Twin engine that sits so beautifully at its heart. Make it even more of a conversation piece with the addition of a custom cover, classic chrome hardware, or some eye-catching trim.

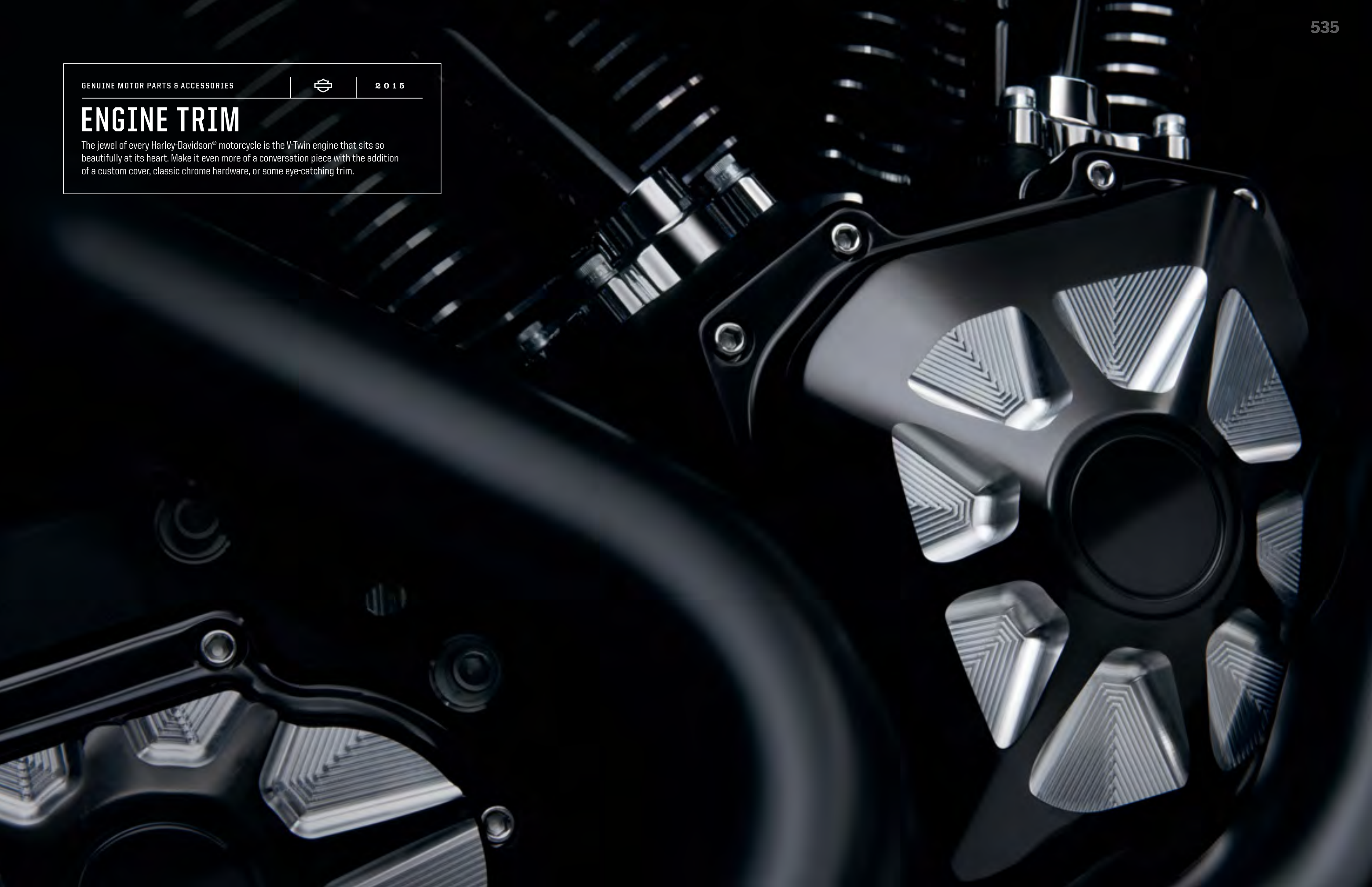

# 536 ENGINE TRIM

Burst Collection

## THE BURST COLLECTION

Split with tradition. The Burst Collection takes your ride in a new hard-edged direction. With a rich mixture of tuxedo black and machined aluminum finishes, each component in this complete collection is designed to tie the look together. The combination of contrasting edges and the light-enhancing machined pattern makes a powerful visual statement that complements classic and contemporary customizing styles. The Burst Collection components create an impact all by themselves, but can also be seamlessly combined with Edge Cut and other gloss black accessories to complete the look.

### A. THE BURST COLLECTION ENGINE COVERS

The Twin Cam engine is the focal point of your motorcycle, so dress it with pride. Burst Collection Engine Covers set the stage for a complete custom look. We start with beautifully polished cast or billet parts that are engineered to fit the bike perfectly. Then we apply a rich "tuxedo black" anodized finish and meticulously machine away the surface to expose the satin aluminum below. Start with a couple of components, or go all the way. The components replace the Original Equipment covers for superior fit. Complete the look with gloss black primary and transmission top covers (sold separately). Kits include chrome hardware.

**25700249** Cam Cover. **\$204.95**  
Fits '01-later Dyna®, Softail®, Touring and Trike models (except '01 EFI Touring).

**25700250** Derby Cover. **\$159.95**  
Fits '99-later Evolution® 1340 and Twin Cam-equipped models (except FLHTCUL, FLHTKL or '07-later Touring or Trike models equipped with Narrow-Profile Outer Primary Cover P/N 25700385 or 25700438). Installation on '06-later Dyna and '07-later Touring, Trike and Softail models require separate purchase of Gasket P/N 25416-99C.

**25700251** Rocker Box Covers. **\$279.95**  
Fits '99-later Touring and Trike models. Sold in pairs.

**34800012** Transmission Side Cover. **\$204.95**  
Fits '08-'09 FXDF, '10-later Dyna and '07-later Softail (except FXCW, FXCWC and FXSB) and Touring models. Does not fit models equipped with hydraulic clutch activation.

### B. THE BURST COLLECTION PERFORMANCE AIR CLEANER KIT

Performance and style combined. Designed to complement the Burst Collection, this radical low profile air cleaner features a "tuxedo black" surround that has been expertly machined to expose the satin aluminum finish below. The billet cover conceals a one-piece cast back plate with integral breather and mounting bracket that promotes smooth air flow into the throttle body. The exposed reverse cone synthetic element provides high-volumes of air, and the element is washable for maximum efficiency and protection. The complete kit includes Burst Collection trim, backing plate, air cleaner element, and all required installation hardware. All EFI-equipped models require ECM calibration\* (priced separately).

**29000066** **\$374.95**  
Fits '08-later Touring and Trike models with Original Equipment 50mm throttle body or with Screamin' Eagle Street Performance Big Bore Stage 4 Kit P/N 92500011 or 92500020.

**29400178** **\$374.95**  
Fits '08-later Dyna and Softail models (except '11-'12 FLSTSE2/3, '13-'14 FXSBSE and '14-'15 FLSTNSE).

\*Recalibration is required for proper installation, and will allow engine to rev to 6200 RPM. See Dealer for details. Labor cost not included.



A. THE BURST COLLECTION ENGINE COVERS



A. THE BURST COLLECTION DERBY COVER



B. THE BURST COLLECTION PERFORMANCE AIR CLEANER KIT



A. THE BURST COLLECTION ENGINE COVERS

Notice: The prices appearing in this catalog are the manufacturer's suggested retail prices. Actual retail prices may vary.



# ENGINE TRIM 537

Derby, Timer & Air Cleaner Trim



C. WILLIE G SKULL COLLECTION DERBY COVER

## C. WILLIE G SKULL COLLECTION

Add a little attitude to your ride. Styled to complement Harley-Davidson® Skull accessory items, the menacing raised skull with black-filled eyes leaps from a field of chrome. The surrounding "Harley-Davidson Motorcycles" script is the perfect finishing touch. This complete collection of engine covers dresses your bike for a true custom look.

### 1. 25441-04A Derby Cover. \$59.95

Fits '99-later Evolution® 1340 and Twin Cam-equipped models (except FLHTCUL, FLHTKL or '07-later Touring or Trike models equipped with Narrow-Profile Outer Primary Cover P/N 25700385 or 25700438). Installation on '06-later Dyna® and '07-later Softail®, Touring and Trike models requires separate purchase of Gasket P/N 25416-99C. Includes chrome-plated stainless steel mounting hardware.

### 2. 25440-04A Derby Cover. \$64.95

Fits '04-later XL and XR models. Includes chrome-plated stainless steel mounting hardware.

### 3. 32975-04A Timer Cover. \$28.95

Fits '99-later Twin Cam-equipped models. Includes chrome-plated stainless steel mounting hardware.

### 4. 32972-04A Timer Cover. \$28.95

Fits '04-later XL, XR and earlier models with horizontal holes on timer cover. Includes chrome-plated stainless steel mounting hardware.

### 5. 29417-04 Air Cleaner Trim. \$44.95

Fits Evolution 1340 models, '99-'08 Dyna, '00-later Softail (except FXS, FLS and FLSTSB) and '99-'13 Touring and Trike models with Original Equipment air cleaner cover. Also fits models equipped with Screamin' Eagle® Round Stage I Air Cleaner Kits with separate purchase of Rain Sock Kit P/N 28728-10.

### 6. 61300217 Air Cleaner Trim. \$49.95

Fits '14-later Touring and Trike models (except CVO™) with Original Equipment air cleaner cover.

### 7. 27939-08 Air Cleaner Trim. \$59.95

Fits '08-later Dyna models (except FXDSE2, FXDFSE and '13-later FXDB) with Original Equipment air cleaner cover.

### 8. 61400007 Air Cleaner Trim. \$49.95

Fits '08-'11 FLSTSB and '11-later FLS and FXS models with Original Equipment air cleaner cover and Bobber-Style Round Air Cleaner Cover P/N 61300128 and 61300120.

### 9. 29416-04 Air Cleaner Trim. \$43.95

Fits '04-later XL models (except XL1200V) with Original Equipment oval air cleaner cover.



C. WILLIE G SKULL COLLECTION

#### Model Family Fitment:

- V-ROD
- SPORTSTER
- DYNA
- SOFTAIL
- TOURING

Notice: The prices appearing in this catalog are the manufacturer's suggested retail prices. Actual retail prices may vary.

# 538 ENGINE TRIM

Derby, Timer & Air Cleaner Trim

## A. DARK CUSTOM™ LOGO COLLECTION

The famous Harley-Davidson #1 logo with a sinister twist. Machined from billet aluminum, these covers feature domed surfaces that are polished and black anodized to a rich satin sheen, and then re-machined to expose the raw aluminum. The resulting high-contrast design complements both polished and painted engine finishes.

**1. 25562-09** Derby Cover. **\$144.95**  
Fits '99-later Evolution® 1340 and Twin Cam-equipped models (except FLHTCUL, FLHTKL or '07-later Touring or Trike models equipped with Narrow-Profile Outer Primary Cover P/N 25700385 or 25700438). Installation on '06-later Dyna® and '07-later Softail®, Touring and Trike models requires separate purchase of Gasket P/N 25416-99C.

**1. 25700434** Derby Cover. **\$139.95**  
Fits '15-later FLHTCUL, FLHTKL and '07-later Touring and Trike models equipped with Narrow-Profile Outer Primary Cover P/N 25700385 or 25700438.

**2. 25563-09** Derby Cover. **\$144.95**  
Fits '04-later XL models.

**3. 32414-09** Timer Cover. **\$64.95**  
Fits '99-later Twin Cam-equipped models.

**4. 32415-09** Timer Cover. **\$64.95**  
Fits '04-later XL, XR and earlier models with horizontal holes on timer cover.

**5. 61300057** Air Cleaner Trim. **\$114.95**  
Fits Evolution 1340 models, '99-'08 Dyna, '00-later Softail (except FXS, FLS and FLSTSB) and '99-'13 Touring and Trike models with Original Equipment air cleaner cover. Also fits models equipped with Screamin' Eagle® Round Stage I Air Cleaner Kits with separate purchase of Rain Sock Kit P/N 28728-10.

**6. 61300224** Air Cleaner Trim. **\$69.95**  
Fits '14-later Touring and Trike models (except CVO™) with Original Equipment air cleaner cover.

**7. 61300056** Air Cleaner Trim. **\$114.95**  
Fits '08-later Dyna models (except FXDSE2, FXDFSE and '13-later FXDB) with Original Equipment air cleaner cover.

**8. 61300058** Air Cleaner Trim. **\$114.95**  
Fits '08-later FLSTSB and '11-later FLS and FXS models with Original Equipment air cleaner cover.

**9. 61300055** Air Cleaner Trim. **\$114.95**  
Fits '04-later XL models (except XL1200V) with Original Equipment oval air cleaner cover.



A. DARK CUSTOM LOGO COLLECTION DERBY COVER

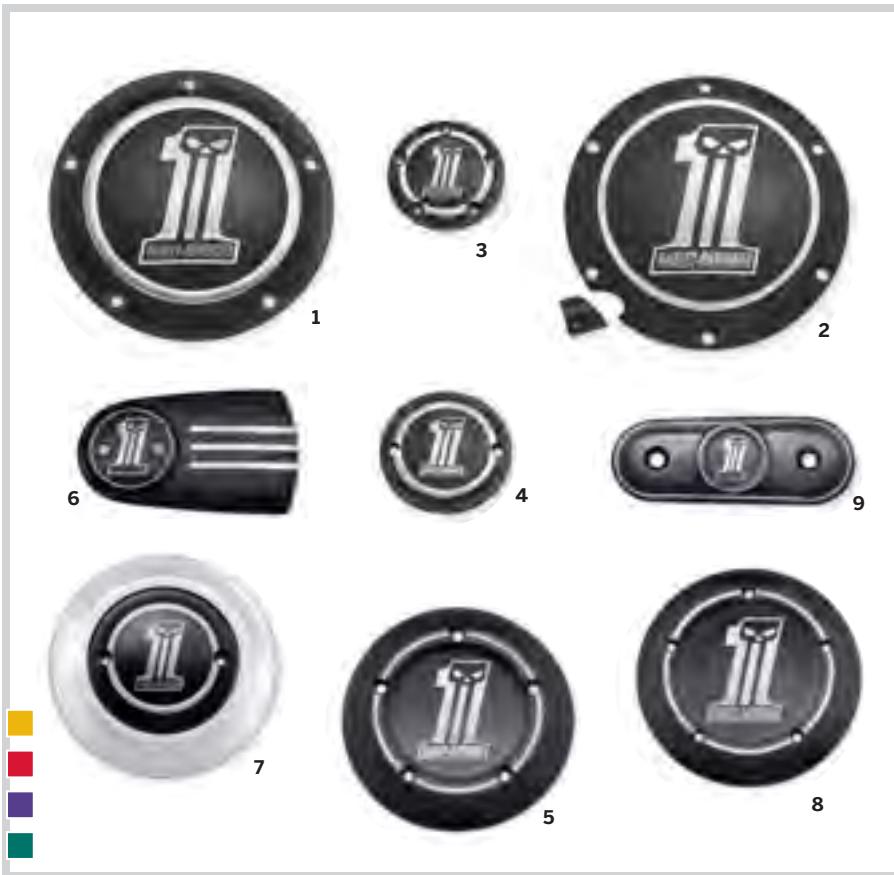

A. DARK CUSTOM LOGO COLLECTION

Notice: The prices appearing in this catalog are the manufacturer's suggested retail prices. Actual retail prices may vary.



NEW

# ENGINE TRIM 539

Derby, Timer & Air Cleaner Trim



B. NUMBER ONE SKULL COLLECTION DERBY COVER – 103 LOGO

## B. NUMBER ONE SKULL COLLECTION

The sinister Harley-Davidson #1 Skull logo dresses for a night on the town. This complete die-cast aluminum collection has been polished and chrome-plated to a brilliant shine, then finished with a contrasting black-filled Dark Custom™ Skull logo. The black-filled race track stripe and recessed hardware pockets provide added depth and dimension. Includes chrome-plated mounting hardware.

- |   |                              |                 |
|---|------------------------------|-----------------|
| <b>1. 61400089</b>  | Derby Cover – 103 Logo.      | <b>\$74.95</b>  |
| <b>2. 25331-10</b>  | Derby Cover.                 | <b>\$74.95</b>  |
| Fits '99-later Evolution® 1340 and Twin Cam-equipped models (except FLHTCUL, FLHTKL or '07-later Touring or Trike models equipped with Narrow-Profile Outer Primary Cover P/N 25700385 or 25700438). Installation on '06-later Dyna® and '07-later Softail®, Touring and Trike models requires separate purchase of Gasket P/N 25416-99C. |                              |                 |
| <b>2. 25700435</b>  | Derby Cover – Billet.        | <b>\$139.95</b> |
| Fits '15-later FLHTCUL, FLHTKL and '07-later Touring and Trike models equipped with Narrow-Profile Outer Primary Cover P/N 25700385 or 25700438.  |                              |                 |
| <b>3. 25333-10</b>  | Derby Cover.                 | <b>\$74.95</b>  |
| Fits '04-later XL models.   |                              |                 |
| <b>4. 32519-10</b>  | Timer Cover.                 | <b>\$28.95</b>  |
| Fits '99-later Twin Cam-equipped models.  |                              |                 |
| <b>5. 32520-10</b>  | Timer Cover.                 | <b>\$28.95</b>  |
| Fits '04-later XL, XR and earlier models with horizontal holes on timer cover.  |                              |                 |
| <b>6. 27956-10</b>  | Air Cleaner Trim.            | <b>\$49.95</b>  |
| <b>7. 29820-11</b>  | Air Cleaner Trim – 103 Logo. | <b>\$49.95</b>  |
| Fits Evolution 1340 models, '99-'08 Dyna, '00-later Softail (except FXS, FLS and FLSTSB) and '99-'13 Touring and Trike models with Original Equipment air cleaner cover. Also fits models equipped with Screamin' Eagle® Round Stage I Air Cleaner Kits with separate purchase of Rain Sock Kit P/N 28728-10.                             |                              |                 |
| <b>8. 27958-10</b>  | Air Cleaner Trim.            | <b>\$59.95</b>  |
| Fits '08-later Dyna models (except FXDSE2, FXDFSE and '13-later FXDB) with Original Equipment air cleaner cover.  |                              |                 |
| <b>9. 61300218</b>  | Air Cleaner Trim.            | <b>\$49.95</b>  |
| Fits '14-later Touring and Trike models (except CVO™) with Original Equipment air cleaner cover.  |                              |                 |
| <b>10. 27957-10</b>   | Air Cleaner Trim.            | <b>\$45.95</b>  |
| Fits '04-later XL models (except XL1200V) equipped with Original Equipment oval air cleaner cover.  |                              |                 |
| <b>11. 60826-11</b>   | Transmission Trim.           | <b>\$25.95</b>  |
| Fits '11-later models equipped with 103CI Twin Cam engine option.   |                              |                 |

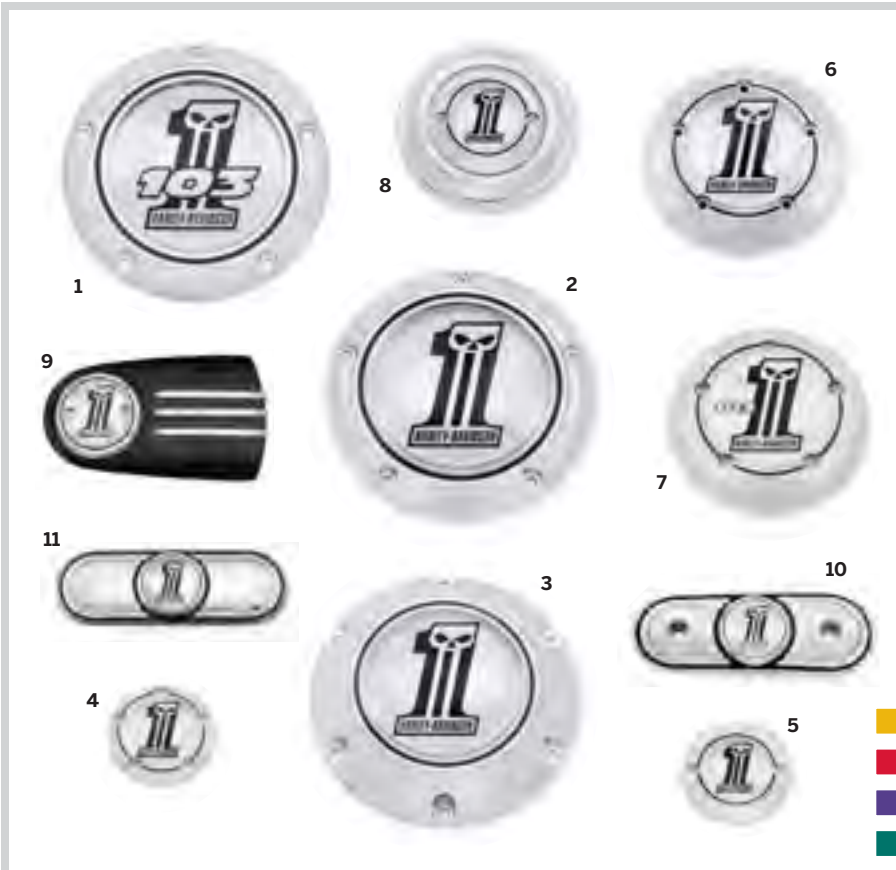

B. NUMBER ONE SKULL COLLECTION

### Model Family Fitment:

- |         |           |      |
|---------|-----------|------|
| V-ROD   | SPORTSTER | DYNA |
| SOFTAIL | TOURING   |      |

Notice: The prices appearing in this catalog are the manufacturer's suggested retail prices. Actual retail prices may vary.

# 540 ENGINE TRIM

Derby, Timer & Air Cleaner Trim

## A. DIAMOND ICE COLLECTION ENGINE TRIM

Add a touch of "bling" to your ride. Set against mirror-polished chrome, these crystal clear rhinestones add a brilliant flash, and dance in the direct sunlight. This complete line of engine trim is easy to install, and adds a bold and bright rhinestone-encrusted Bar & Shield logo to the profile of your bike. Kits include chrome-plated mounting hardware.

- |   |                   |                |
|---|-------------------|----------------|
| <b>1. 25339-10</b>  | Derby Cover.      | <b>\$94.95</b> |
| Fits '99-later Evolution® 1340 and Twin Cam-equipped models (except FLHTCUL, FLHTKL or '07-later Touring or Trike models equipped with Narrow-Profile Outer Primary Cover P/N 25700385 or 25700438). Installation on '06-later Dyna® and '07-later Softail®, Touring and Trike models requires separate purchase of Gasket P/N 25416-99C. |                   |                |
| <b>2. 25341-10</b>  | Derby Cover.      | <b>\$89.95</b> |
| Fits '04-later XL and XR models.  |                   |                |
| <b>3. 32526-10</b>  | Timer Cover.      | <b>\$54.95</b> |
| Fits '99-later Twin Cam models.   |                   |                |
| <b>4. 32541-10</b>  | Timer Cover.      | <b>\$49.95</b> |
| Fits '04-later XL, XR and earlier models with horizontal holes on timer cover.  |                   |                |
| <b>5. 27960-10</b>  | Air Cleaner Trim. | <b>\$59.95</b> |
| Fits Evolution 1340 models, '99-'08 Dyna, '00-later Softail (except FXS, FLS and FLSTSB) and '99-'13 Touring and Trike models with Original Equipment air cleaner cover. Also fits models equipped with Screamin' Eagle® Round Stage I Air Cleaner Kits with separate purchase of Rain Sock Kit P/N 28728-10.                             |                   |                |
| <b>6. 61300223</b>  | Air Cleaner Trim. | <b>\$69.95</b> |
| Fits '14-later Touring and Trike models (except CVO™) with Original Equipment air cleaner cover.  |                   |                |
| <b>7. 27965-10</b>  | Air Cleaner Trim. | <b>\$65.95</b> |
| Fits '08-later Dyna models (except FXDSE2, FXDFSE and '13-later FXDB) with Original Equipment air cleaner cover.  |                   |                |
| <b>8. 27961-10</b>  | Air Cleaner Trim. | <b>\$59.95</b> |
| Fits '04-later XL models (except XL1200V) equipped with Original Equipment oval air cleaner cover.  |                   |                |

Shown with:

### DIAMOND ICE COLLECTION FLAT MEDALLIONS

Diamond Ice Medallions are designed for installation on flat surfaces and the self-adhesive backing holds the Bar & Shield shaped emblem firmly in place.

- |  |        |                |
|--|--------|----------------|
| <b>9. 92469-10</b>                                   | Large. | <b>\$27.95</b> |
| Approximate dimensions: Length 3.5"; Height 2.5".    |        |                |
| <b>10. 92468-10</b>                                  | Small. | <b>\$22.95</b> |
| Approximate dimensions: Length 1.625"; Height 1.25". |        |                |



A. DIAMOND ICE COLLECTION DERBY COVER

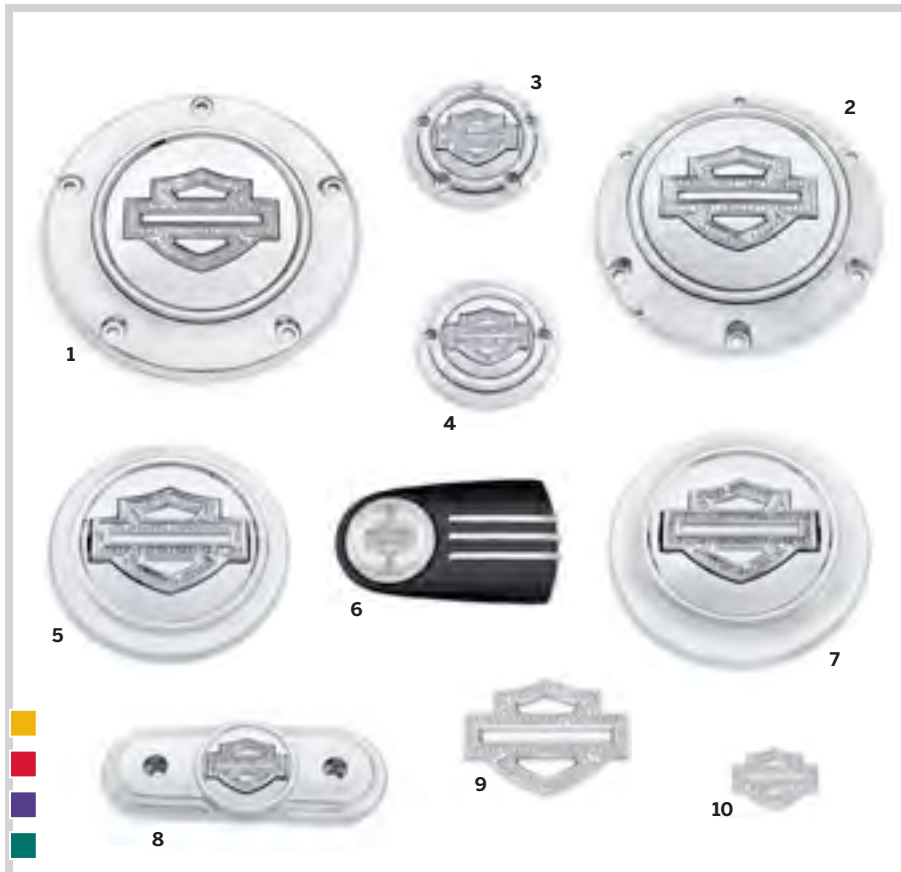

A. DIAMOND ICE COLLECTION

Notice: The prices appearing in this catalog are the manufacturer's suggested retail prices. Actual retail prices may vary.



NEW

# ENGINE TRIM 541

Derby, Timer & Air Cleaner Trim



B. HARLEY-DAVIDSON MOTOR CO. COLLECTION DERBY COVER

## B. HARLEY-DAVIDSON® MOTOR CO. COLLECTION

This collection personifies Harley style. It had better, because we put our name on it – The Harley-Davidson Motor Co. Collection.

- |   |                          |                |
|---|--------------------------|----------------|
| <b>1. 25338-99A</b>   | Derby Cover.             | <b>\$46.95</b> |
| Fits '99-later Evolution® 1340 and Twin Cam-equipped models (except FLHTCUL, FLHTKL or '07-later Touring or Trike models equipped with Narrow-Profile Outer Primary Cover P/N 25700385 or 25700438). Installation on '06-later Dyna® and '07-later Softail®, Touring and Trike models requires separate purchase of Gasket P/N 25416-99C. Includes chrome-plated stainless steel mounting hardware. |                          |                |
| <b>1. 25700436</b>  | Derby Cover – Billet.    | <b>\$99.95</b> |
| Fits '15-later FLHTCUL, FLHTKL and '07-later Touring and Trike models equipped with Narrow-Profile Outer Primary Cover P/N 25700385 or 25700438.  |                          |                |
| <b>2. 25330-98</b>  | Derby Cover – 3-Hole.    | <b>\$59.95</b> |
| Fits '70-'98 models (except Sportster®).  |                          |                |
| <b>3. 25130-04A</b>   | Derby Cover.             | <b>\$46.95</b> |
| Fits '04-later XL and XR models. Includes chrome-plated stainless steel mounting hardware.  |                          |                |
| <b>25332-98</b>   | Derby Cover (Not shown). | <b>\$46.95</b> |
| Fits '94-'03 Sportster models.  |                          |                |
| <b>4. 32047-99A</b>   | Timer Cover.             | <b>\$28.95</b> |
| Fits '99-later Twin Cam-equipped models. Includes chrome-plated stainless steel mounting hardware.  |                          |                |
| <b>5. 32666-98</b>  | Timer Cover.             | <b>\$25.95</b> |
| Fits models with vertical holes on timer cover.   |                          |                |
| <b>6. 32668-98A</b>   | Timer Cover.             | <b>\$25.95</b> |
| Fits '04-later XL, XR and earlier models with horizontal holes on timer cover. Includes chrome-plated stainless steel mounting hardware.  |                          |                |
| <b>7. 61300254</b>  | Air Cleaner Trim.        | <b>\$49.95</b> |
| Fits '14-later Touring and Trike models (except CVO™) with Original Equipment air cleaner cover.  |                          |                |
| <b>8. 27938-08</b>  | Air Cleaner Trim.        | <b>\$49.95</b> |
| Fits '08-later Dyna models (except FXDSE2, FXDFSE/2 and '13 FXDB) with Original Equipment air cleaner cover.  |                          |                |
| <b>9. 29243-97</b>  | Air Cleaner Insert.      | <b>\$19.95</b> |
| Fits Evolution 1340 models, '99-'07 Dyna, '00-'06 Softail (except FXS, FLS and FLSTSB) and '99-'06 Touring models with Original Equipment air cleaner cover.  |                          |                |



B. HARLEY-DAVIDSON MOTOR CO. COLLECTION

### Model Family Fitment:

- |         |           |      |
|---------|-----------|------|
| V-ROD   | SPORTSTER | DYNA |
| SOFTAIL | TOURING   |      |

Notice: The prices appearing in this catalog are the manufacturer's suggested retail prices. Actual retail prices may vary.

# 542 ENGINE TRIM

Derby, Timer & Air Cleaner Trim

## A. THE HARLEY-DAVIDSON® “LIVE TO RIDE” COLLECTION – CHROME

“Live To Ride, Ride to Live.” It has become the motto of the Harley-Davidson nation, accompanying riders over millions of miles of travel. This collection is a tribute to that way of life.

<b>1. 61400085</b>	Derby Cover – 103 Logo.	<b>\$48.95</b>
<b>2. 25372-02A</b>	Derby Cover.	<b>\$48.95</b>
Fits '99-later Evolution® 1340 and Twin Cam-equipped models (except FLHTCUL, FLHTKL or '07-later Touring or Trike models equipped with Narrow-Profile Outer Primary Cover P/N 25700385 or 25700438). Installation on '06-later Dyna® and '07-later Softail®, Touring and Trike models requires separate purchase of Gasket P/N 25416-99C. Includes chrome-plated stainless steel mounting hardware.		
<b>3. 25391-84T</b>	Derby Cover.	<b>\$59.95</b>
Fits '70-'98 models (except XL models).		
<b>4. 32698-02A</b>	Timer Cover.	<b>\$28.95</b>
Fits '99-later Twin Cam-equipped models. Includes chrome-plated stainless steel mounting hardware.		
<b>5. 32581-85T</b>	Timer Cover.	<b>\$28.95</b>
Fits '04-later XL, XR and earlier models with horizontal holes on timer cover.		
<b>32585-89T</b>	Timer Cover. (not shown)	<b>\$28.95</b>
Fits models with vertical mounting holes.		
<b>6. 29341-02</b>	Air Cleaner Trim.	<b>\$32.95</b>
<b>7. 29378-11</b>	Air Cleaner Trim – 103 Logo.	<b>\$38.95</b>
Fits Evolution 1340 models, '99-'08 Dyna, '00-later Softail (except FXS, FLS and FLSTSB) and '99-'13 Touring and Trike models with Original Equipment air cleaner cover. Also fits models equipped with Screamin' Eagle® Round Stage I Air Cleaner Kits with separate purchase of Rain Sock Kit P/N 28728-10.		
<b>8. 61300219</b>	Air Cleaner Trim.	<b>\$49.95</b>
Fits '14-later Touring and Trike models (except CVO™) with Original Equipment air cleaner cover.		
<b>9. 60825-11</b>	Transmission Trim.	<b>\$26.95</b>
Fits '11-later models equipped with 103CI Twin Cam engine option.		



A. HARLEY-DAVIDSON “LIVE TO RIDE” DERBY COVER – CHROME



### Model Family Fitment:

<span style="display: inline-block; width: 10px; height: 10px; background-color: gray; border: 1px solid black;"></span> V-ROD	<span style="display: inline-block; width: 10px; height: 10px; background-color: yellow; border: 1px solid black;"></span> SPORTSTER	<span style="display: inline-block; width: 10px; height: 10px; background-color: red; border: 1px solid black;"></span> DYNA
<span style="display: inline-block; width: 10px; height: 10px; background-color: purple; border: 1px solid black;"></span> SOFTAIL	<span style="display: inline-block; width: 10px; height: 10px; background-color: teal; border: 1px solid black;"></span> TOURING	

A. HARLEY-DAVIDSON “LIVE TO RIDE” COLLECTION – CHROME

Notice: The prices appearing in this catalog are the manufacturer's suggested retail prices. Actual retail prices may vary.



# ENGINE TRIM 543

Derby, Timer & Air Cleaner Trim



**B. HARLEY-DAVIDSON "LIVE TO RIDE" DERBY COVER – GOLD**

## B. THE HARLEY-DAVIDSON® "LIVE TO RIDE" COLLECTION – GOLD

"Live To Ride, Ride to Live." It has become the motto of the Harley-Davidson nation, accompanying riders over millions of miles of travel. This collection is a tribute to that way of life.

**1. 61400086** Derby Cover – 103 Logo. **\$64.95**

**2. 25340-99A** Derby Cover. **\$69.95**

Fits '99-later Evolution® 1340 and Twin Cam-equipped models (except FLHTCUL, FLHTKL or '07-later Touring or Trike models equipped with Narrow-Profile Outer Primary Cover P/N 25700385 or 25700438). Installation on '06-later Dyna® and '07-later Softail®, Touring and Trike models requires separate purchase of Gasket P/N 25416-99C. Includes chrome-plated stainless steel mounting hardware.

**3. 25391-90T** Derby Cover. **\$64.95**  
Fits '70-'98 models (except Sportster® models).

**4. 25127-04A** Derby Cover. **\$69.95**  
Fits '04-later XL and XR models. Includes chrome-plated stainless steel mounting hardware.

**25398-95T** Derby Cover. (not shown) **\$64.95**  
Fits '94-'03 Sportster models.

**5. 32689-99A** Timer Cover. **\$36.95**  
Fits '99-later Twin Cam-equipped models. Includes chrome-plated stainless steel mounting hardware.

**6. 32585-90T** Timer Cover. **\$37.95**  
Fits models with vertical mounting holes.

**32581-90TB** Timer Cover. (not shown) **\$37.95**  
Fits '04-later XL, XR and earlier models with horizontal holes on timer cover. Includes chrome-plated stainless steel mounting hardware.

**7. 29328-99** Air Cleaner Trim. **\$44.95**

**8. 61400023** Air Cleaner Trim – 103 Logo. **\$43.95**

Fits Evolution 1340 models, '99-'08 Dyna, '00-later Softail (except FXS, FLS and FLSTSB) and '99-'13 Touring and Trike models with Original Equipment air cleaner cover. Also fits models equipped with Screamin' Eagle® Round Stage I Air Cleaner Kits with separate purchase of Rain Sock Kit P/N 28728-10.

**9. 61300220** Air Cleaner Trim. **\$59.95**  
Fits '14-later Touring and Trike models (except CVO™) with Original Equipment air cleaner cover.

**10. 29289-90T** Air Cleaner Trim. **\$49.95**  
Fits Evolution 1340-equipped models with 8" round air cleaner.

**11. 27929-08** Dyna Air Cleaner Trim. **\$59.95**  
Fits '08-later Dyna models (except FXDSE2, FXDFSE/2 and '13-later FXDB) with Original Equipment air cleaner cover.

**12. 29823-04** Air Cleaner Trim. **\$43.95**  
Fits '04-later XL models (except XL1200V) with Original Equipment oval air cleaner.

**13. 29405-90T** Oval Air Cleaner Trim. **\$49.95**  
Fits '66-'78 and '83-'03 XL models, '67-early '78 FL, and '71-early '78 FX models.

**14. 61400025** Transmission End Cover Trim. **\$31.95**  
Fits '11-later Touring models equipped with 103CI Twin Cam engine option.

**60653-92T** Chain Inspection Cover. (not shown) **\$39.95**  
Fits '85-'06 Electra Glide®, '98-'06 Road Glide®, '85-'96 Tour Glide™ and '94-'06 Road King® models.



**B. HARLEY-DAVIDSON "LIVE TO RIDE" COLLECTION – GOLD**

Notice: The prices appearing in this catalog are the manufacturer's suggested retail prices. Actual retail prices may vary.

# 544 ENGINE TRIM

Derby, Timer & Air Cleaner Trim

## A. THE FLAMES COLLECTION – CHROME

Ever since they began emerging on gas tanks a few decades ago, flames have been a symbol of custom styling. Now, Harley-Davidson® continues the tradition with the Flames Collection.

**1. 61400087** Derby Cover – 103 Logo. **\$48.95**

**2. 25336-06** Derby Cover. **\$48.95**

Fits '99-later Evolution® 1340 and Twin Cam-equipped models (except FLHTCUL, FLHTKL or '07-later Touring or Trike models equipped with Narrow-Profile Outer Primary Cover P/N 25700385 or 25700438). Installation on '06-later Dyna® and '07-later Softail®, Touring and Trike models requires separate purchase of Gasket P/N 25416-99C. Includes chrome-plated stainless steel mounting hardware.

**3. 32964-06** Timer Cover. **\$28.95**

Fits '99-later Twin Cam-equipped models. Includes chrome-plated stainless steel mounting hardware.

**4. 29430-06** Air Cleaner Trim. **\$34.95**

**5. 29972-11** Air Cleaner Trim – 103 Logo. **\$34.95**

Fits Evolution 1340 models, '99-'08 Dyna, '00-later Softail (except FXS, FLS and FLSTSB) and '99-'13 Touring and Trike models with Original Equipment air cleaner cover. Also fits models equipped with Screamin' Eagle® Round Stage I Air Cleaner Kits with separate purchase of Rain Sock Kit P/N 28728-10.

**6. 61300221** Air Cleaner Trim. **\$49.95**

Fits '14-later Touring and Trike models (except CVO™) with Original Equipment air cleaner cover.

**7. 27937-08** Air Cleaner Trim. **\$54.95**

Fits '08-later Dyna models (except FXDSE2, FXDFSE/2 and '13-later FXDB) with Original Equipment air cleaner cover.

**8. 60845-11** Transmission Trim. **\$25.95**

Fits '11-later models equipped with 103CI Twin Cam engine option.



A. FLAMES COLLECTION DERBY COVER – CHROME



A. FLAMES COLLECTION – CHROME

*Notice: The prices appearing in this catalog are the manufacturer's suggested retail prices. Actual retail prices may vary.*



# ENGINE TRIM 545

Derby, Timer & Air Cleaner Trim



**B. FLAMES COLLECTION DERBY COVER – GOLD & CHROME**

## B. THE FLAMES COLLECTION – GOLD & CHROME

Ever since they began emerging on gas tanks a few decades ago, flames have been a symbol of custom styling. Now, Harley-Davidson® continues the tradition with the Flames Collection.

**1. 61400088** Derby Cover – 103 Logo. **\$64.95**

**2. 25334-99A** Derby Cover. **\$64.95**

Fits '99-later Evolution® 1340 and Twin Cam-equipped models (except FLHTCUL, FLHTKL or '07-later Touring or Trike models equipped with Narrow-Profile Outer Primary Cover P/N 25700385 or 25700438). Installation on '06-later Dyna® and '07-later Softail®, Touring and Trike models requires separate purchase of Gasket P/N 25416-99C. Includes chrome-plated stainless steel mounting hardware.

**3. 25125-04A** Derby Cover. **\$69.95**

Fits '04-later XL and XR models. Includes chrome-plated stainless steel mounting hardware.

**4. 32662-99A** Timer Cover. **\$37.95**

Fits '99-later Twin Cam-equipped models. Includes chrome-plated stainless steel mounting hardware.

**5. 32571-98A** Timer Cover. **\$28.95**

Fits '04-later XL, XR and earlier models with horizontal holes on timer cover. Includes chrome-plated stainless steel mounting hardware.

**6. 29415-99** Air Cleaner Trim. **\$49.95**

**7. 61400022** Air Cleaner Trim – 103 Logo. **\$44.95**

Fits Evolution 1340 models, '99-'08 Dyna, '00-later Softail (except FXS, FLS and FLSTSB) and '99-'13 Touring and Trike models with Original Equipment air cleaner cover. Also fits models equipped with Screamin' Eagle® Round Stage I Air Cleaner Kits with separate purchase of Rain Sock Kit P/N 28728-10.

**8. 61300222** Air Cleaner Trim. **\$59.95**

Fits '14-later Touring and Trike models (except CVO™) with Original Equipment air cleaner cover.

**9. 29824-04** Air Cleaner Trim. **\$43.95**

Fits '04-later XL models (except XL1200V) equipped with Original Equipment oval air cleaner.

**10. 61400024** Transmission End Cover Trim. **\$31.95**

Fits '11-later Touring models equipped with 103CI Twin Cam engine option.



**B. FLAMES COLLECTION – GOLD & CHROME**

### Model Family Fitment:

- V-ROD
- SPORTSTER
- DYNA
- SOFTAIL
- TOURING

*Notice: The prices appearing in this catalog are the manufacturer's suggested retail prices. Actual retail prices may vary.*

# 546 ENGINE TRIM

Derby, Timer & Air Cleaner Trim

## A. SKULL & CHAIN COLLECTION – CHROME

Links to the dark side. This collection stands out in a crowd, with a contrasting 3-D chain that rims the surface and surrounds the distinctive raised Willie G Skull. Select from the traditional skull design, or for a little added flash, choose the version with the bright jewel-encrusted jaw line. Either way, this complete collection is a tribute to the mechanical side of your ride.

### 1. Derby Cover

Fits '99-later Evolution® 1340 and Twin Cam-equipped models (except FLHTCUL, FLHTKL or '07-later Touring or Trike models equipped with Narrow-Profile Outer Primary Cover P/N 25700385 or 25700438). Installation on '06-later Dyna® and '07-later Softail®, Touring and Trike models require separate purchase of Gasket P/N 25416-99C. Includes chrome-plated stainless steel hardware.

<b>25700258</b>	Chrome – Skull.	<b>\$89.95</b>
<b>25700062</b>	Chrome – Jeweled Skull.	<b>\$89.95</b>
<b>25700256</b>	Smokey Chrome – Skull.	<b>\$89.95</b>
<b>25700130</b>	Smokey Chrome – Jeweled Skull.	<b>\$89.95</b>

### 2. Derby Cover

Fits '04-later XL and XR models. Includes chrome-plated stainless steel hardware.

<b>25700257</b>	Chrome – Skull.	<b>\$89.95</b>
<b>25700255</b>	Smokey Chrome – Skull.	<b>\$89.95</b>

### 3. Timer Cover

Fits '99-later Twin Cam models. Includes chrome-plated stainless steel hardware.

<b>25600028</b>	Chrome – Skull.	<b>\$41.95</b>
<b>25600002</b>	Chrome – Jeweled Skull.	<b>\$41.95</b>
<b>25600026</b>	Smokey Chrome – Skull.	<b>\$41.95</b>

### 4. Timer Cover

Fits '04-later XL, XR and earlier models with horizontal holes on timer cover. Includes chrome-plated stainless steel hardware.

<b>25600027</b>	Chrome – Skull.	<b>\$41.95</b>
<b>25600003</b>	Chrome – Jeweled Skull.	<b>\$41.95</b>
<b>25600025</b>	Smokey Chrome – Skull.	<b>\$41.95</b>

### 5. Air Cleaner Trim

Fits Evolution 1340 models, '99-'08 Dyna, '00-later Softail (except FXS, FLS and FLSTSB) and '99-'13 Touring and Trike models with Original Equipment air cleaner cover. Also fits models equipped with Screamin' Eagle® Round Stage I Air Cleaner Kits with separate purchase of Rain Sock Kit P/N 28728-10.

<b>61400167</b>	Chrome – Skull.	<b>\$64.95</b>
<b>61400163</b>	Smokey Chrome – Skull.	<b>\$64.95</b>



A. SKULL & CHAIN COLLECTION DERBY COVER – CHROME (JEWEL SKULL SHOWN)



A. SKULL & CHAIN COLLECTION DERBY COVER – SMOKEY CHROME (JEWEL SKULL SHOWN)



A. SKULL & CHAIN COLLECTION – CHROME



Skull Jeweled Skull



Skull Jeweled Skull

#### Model Family Fitment:

V-ROD	SPORTSTER	DYNA
SOFTAIL	TOURING	

Notice: The prices appearing in this catalog are the manufacturer's suggested retail prices. Actual retail prices may vary.



A. SKULL & CHAIN COLLECTION – SMOKEY CHROME



# ENGINE TRIM 547

Derby, Timer & Air Cleaner Trim

NEW

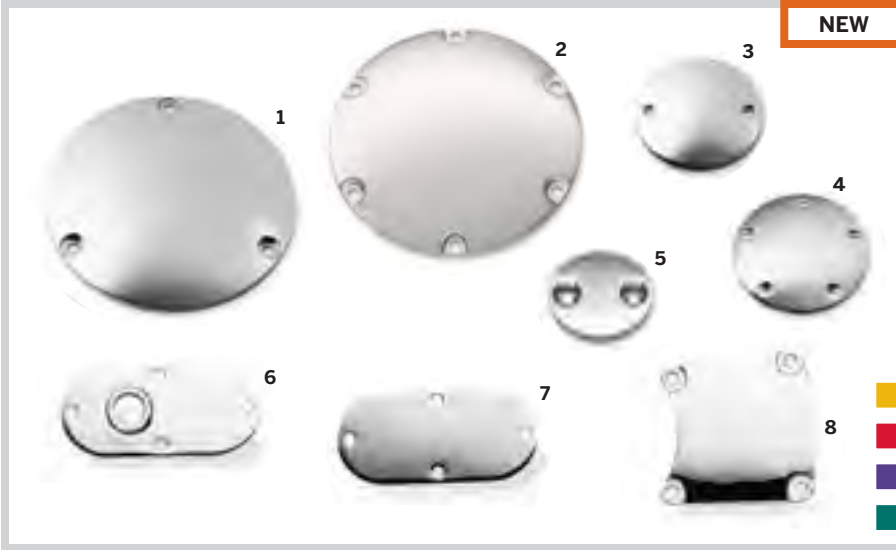

## B. CLASSIC CHROME COVERS

### B. CLASSIC CHROME COVERS

From the design philosophy of less is more, we bring you this collection of basic chrome accessories, which provides a clean, custom look that is guaranteed to turn heads.

**1. 60668-84B** Derby Cover. **\$64.95**  
Fits '70-'98 Big Twin and Evolution® 1340 equipped models.

**60668-99** Derby Cover. (not shown) **\$64.95**  
Fits '99-'05 Dyna® and '99-'06 Softail® and Touring models.

**60766-06** Derby Cover. (not shown) **\$64.95**  
Fits '06-later Dyna and '07-later Softail, Touring and Trike models (except FLHTCUL, FLHTKL or '07-later Touring or Trike models equipped with Narrow-Profile Outer Primary Cover P/N 25700385 or 25700438).

**25700388** Derby Cover. **\$64.95**  
Fits '15-later FLHTCUL, FLHTKL and '07-later Touring and Trike models equipped with Narrow-Profile Outer Primary Cover P/N 25700385 or 25700438.

**2. 34760-04** Derby Cover. **\$69.95**  
Fits '04-later XL models.

**3. 32584-88TA** Timer Cover. **\$25.95**  
Fits '04-later XL, XR and earlier models with horizontal holes on timer cover. Includes chrome-plated stainless steel mounting hardware.

**4. 32679-99A** Timer Cover. **\$25.95**  
Fits Twin Cam-equipped models. Includes chrome-plated stainless steel mounting hardware.

**5. 34761-94** Chain Inspection Cover. **\$39.95**  
Fits '94-'03 XL models.

**34761-04A** Chain Inspection Cover. (not shown) **\$24.95**  
Fits '04-later XL models.

**6. 60529-90A** Chain Inspection Cover. **\$89.95**  
Fits '91-'05 Dyna models (except FXDWG).

**7. 60572-86** Chain Inspection Cover. **\$49.95**  
Fits '93-'05 FXDWG and '86-'06 FXST, FXSTS, FLST models.

**8. 60670-85A** Chain Inspection Cover. **\$54.95**  
Fits '85-'06 Touring models.

### C. BLACK FIN COLLECTION

Finish the sinister black look of your motorcycle with the Black Fin Collection from Harley-Davidson. The raised horizontal lines on these die-cast covers echo the traditional cylinder fin look, and the wrinkle black finish is a perfect match for the blacked-out primary, cam cover and Finned Headbolt Bridge Kit.

**1. 25454-01** Derby Cover. **\$43.95**  
Fits '99-later Evolution 1340 and Twin Cam-equipped models (except FLHTCUL, FLHTKL or '07-later Touring or Trike models equipped with Narrow-Profile Outer Primary Cover P/N 25700385 or 25700438). Installation on '06-later Dyna® and '07-later Softail, Touring and Trike models requires separate purchase of Gasket P/N 25416-99C.

**2. 32677-01** Timer Cover. **\$25.95**  
Fits '99-later Twin Cam-equipped models.

### D. BLACK DERBY COVERS

Available in your choice of wrinkle black or gloss black finish, these simple Derby Covers add a finishing touch to your blacked-out engine.

Fits '06-later Dyna and '07-later Softail, Touring and Trike models (except FLHTCUL, FLHTKL or '07-later Touring or Trike models equipped with Low-Profile Outer Primary P/N 25700385 or 25700438).

**60713-07** Wrinkle Black. **\$39.95**

**25700020** Gloss Black. **\$39.95**

Fits '15-later FLHTCUL, FLHTKL and '07-later Touring and Trike models equipped with Narrow-Profile Outer Primary Cover P/N 25700385 or 25700438.

**25700437** Gloss Black. **\$49.95**

Fits '99-'05 Dyna and '99-'06 Softail and Touring models.

**60713-99** Wrinkle Black. **\$39.95**

Fits '04-later XL models.

**34790-05** Wrinkle Black. **\$39.95**



## C. BLACK FIN COLLECTION

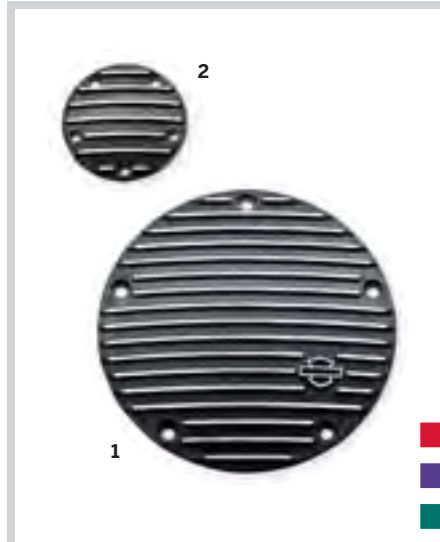

## D. BLACK DERBY COVERS



Notice: The prices appearing in this catalog are the manufacturer's suggested retail prices. Actual retail prices may vary.

# 548 ENGINE TRIM

## Air Cleaner Covers

### A. HARLEY-DAVIDSON® AIR CLEANER COVER

A classic look backed with superior quality, this brilliant chrome Air Cleaner Cover features a black paint-filled "Harley-Davidson" logo. Chrome-plated stainless steel mounting screw included.

**29754-01** **\$69.95**

Fits '02-'13 Touring and Trike models (except '08-later Touring models equipped with Screamin' Eagle® High-Flow Air Cleaner Kits), '04-'07 EFI Dyna®, and '01-later Softail® models (except California and '08-later FXS, FLS and FLSTSB). Screamin' Eagle High-Flow Air Cleaner Kits require the separate purchase of Air Cleaner Adapter Kit P/N 29769-01.

Also available:

#### HARLEY-DAVIDSON AIR CLEANER ADAPTER KIT (not shown)

This adapter kit allows H-D® Air Cleaner Cover P/N 29754-01 to be used with Screamin' Eagle High-Flow Air Cleaner Breather Kits on Twin Cam-equipped models. Includes anti-rotation adapter plate and mounting hardware.

**29769-01** **\$14.95**



A. HARLEY-DAVIDSON AIR CLEANER COVER

### B. NOSTALGIC BAR & SHIELD LOGO AIR CLEANER COVER

Get a polished look with an extra dose of heritage with the Nostalgic Collection – chrome-plated air cleaner covers featuring an original-style Bar & Shield logo and a stamped "Made in U.S.A." An easy-to-install trip down memory lane, each cover is hand-polished and chrome-plated to a brilliant finish. Available in oval and round configurations, the air cleaner kit includes polished stainless steel mounting hardware.

**29765-01** Oval Twin Cam. **\$69.95**

Fits '04-'07 EFI Dyna and '01-later Softail models (except carbureted California and '08-later FXS, FLS and FLSTSB). Also fits '02-'13 Touring and Trike models (except carbureted California models). If installed with Screamin' Eagle High-Flow Air Cleaner Kits, requires the separate purchase of Gasket P/N 29591-99.

**29138-91A** Round. **\$69.95**

Fits '90-'99 carbureted (CV) Evolution® 1340-equipped models. Also fits '07-later XL and '99-later Twin Cam models equipped with Screamin' Eagle High-Flow Air Cleaners (round filter) when installed with Gasket Kit P/N 29591-99 (sold separately).



B. NOSTALGIC BAR & SHIELD LOGO AIR CLEANER COVER – OVAL TWIN CAM

### C. SMOOTH AIR CLEANER COVER

Wrap your Screamin' Eagle round air cleaner element in style. The mirror-chrome low-profile Air Cleaner Cover shields the element and opens breathing space between the backing plate and the cover. Cut-away bottom design exposes the air cleaner element to maximize the airflow. Easy to install, the one-piece cover is the ideal complement to the Chrome Air Cleaner Back Plate P/N 29510-05.

**29153-07** **\$49.95**

Fits '07-later XL models equipped with Screamin' Eagle Round Filter Air Cleaner Kits and '99-later Twin Cam models equipped with Screamin' Eagle Stage Kits or High-Flow Air Cleaner Assembly. '08-later Dyna models require separate purchase of Stage I Air Cleaner Kit P/N 29773-02C.



B. NOSTALGIC BAR & SHIELD LOGO AIR CLEANER COVER – ROUND

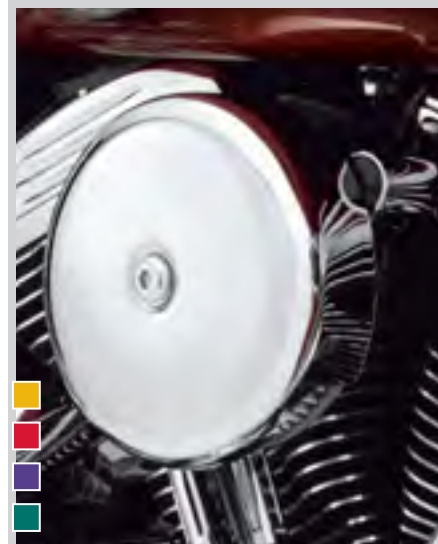

C. SMOOTH AIR CLEANER COVER

Notice: The prices appearing in this catalog are the manufacturer's suggested retail prices. Actual retail prices may vary.



# ENGINE TRIM 549

Air Cleaner Covers



**D. SCREAMIN' EAGLE VENTILATOR ELITE AIR CLEANER COVER – CHROME**



**D. SCREAMIN' EAGLE VENTILATOR ELITE AIR CLEANER COVER – GLOSS BLACK**



**E. BILLET AIR CLEANER COVER – BLACK (SHOWN WITH DARK CUSTOM MEDALLION)**



**E. BILLET AIR CLEANER COVER – CHROME (SHOWN WITH WILLIE G SKULL MEDALLION)**



**E. BILLET AIR CLEANER MEDALLION KITS**

## D. VENTILATOR ELITE AIR CLEANER COVER

Add a luxurious finishing touch to your Ventilator Air Cleaner. Designed as a direct replacement for the Screamin' Eagle® and CVO™ Ventilator Air Cleaners, this easy to install cover features a sleek center bar design surrounded with carbon fiber inserts. Kit includes low-profile cover, diamond-cut Screamin' Eagle medallion and chrome mounting hardware.

Fits Dyna®, Softail®, Touring and Trike models equipped with Screamin' Eagle Ventilator Air Cleaner Kits P/N 29490-09, 29915-09, 28721-10, 28722-10 or 29400039. Also fits CVO models with Original Equipment Ventilator Air Cleaner.

<b>61300516</b>	Chrome.	<b>\$109.95</b>
<b>61300517</b>	Gloss Black.	<b>\$109.95</b>

## E. FORGED BILLET ALUMINUM AIR CLEANER COVER

This unique Billet Aluminum Air Cleaner Cover is styled with inverted V-shape air inlets to complement the V-Twin engine profile, and is designed with a generous open intake to maximize engine breathing. Manufactured from 6061-T6 billet aluminum, this high-quality forged dual throat air cleaner cover is expertly CNC-machined to exacting tolerances. Then, its surfaces are polished mirror-smooth and chrome-plated or black anodized to match your customizing direction. The air cleaner kits include complementing brushed aluminum or matte black side inserts and a hidden mounting bolt. Complete the installation with one of the numerous custom medallion inserts (sold separately).

Fits '99-later Twin Cam, '07-later XL and '93-'99 Evolution® 1340 carbureted models equipped with Screamin' Eagle Round Filter Air Cleaner Kits (round cone-shaped filter). See your dealer for specific applications.

<b>29506-09</b>	Black.	<b>\$229.95</b>
<b>29745-00A</b>	Chrome.	<b>\$229.95</b>

**Also available:**

### BILLET AIR CLEANER SIDE INSERT KIT

Add a touch of color to the H-D® Forged Billet Aluminum Air Cleaner Cover. These easy-to-install Side Inserts are available in a matte black finish to add depth and dimension.

<b>97005-02</b>		<b>\$9.95</b>
Fits Chrome Forged Billet Aluminum Air Cleaner Cover P/N 29745-00A.		

**Also shown with:**

### BILLET AIR CLEANER MEDALLION KITS

These polished and chrome-plated inserts for the Billet Air Cleaner Cover snap easily into place. The kit includes an O-ring gasket and individual decorative medallions.

Fits Forged Billet Aluminum Air Cleaner Covers P/N 29745-00A and 29506-09.

<b>29902-09</b>	Dark Custom™ Collection.	<b>\$42.95</b>
<b>29833-06</b>	Willie G Skull Collection.	<b>\$42.95</b>
<b>29929-07</b>	Screamin' Eagle 96 Cubic Inch.	<b>\$42.95</b>
<b>29888-06</b>	Screamin' Eagle 103 Cubic Inch.	<b>\$42.95</b>
<b>29898-06</b>	Screamin' Eagle 110 Cubic Inch.	<b>\$42.95</b>

**Model Family Fitment:**

■ V-ROD	■ SPORTSTER	■ DYNA
■ SOFTAIL	■ TOURING	

*Notice: The prices appearing in this catalog are the manufacturer's suggested retail prices. Actual retail prices may vary.*

# 550 ENGINE TRIM

## Air Cleaner Covers

### A. BOBBER-STYLE ROUND AIR CLEANER COVER

Low-profile round air cleaner cover adds an attractive nostalgic look to any bike's profile. This cover can be accented with your choice of stylish air cleaner trim collections (sold separately) for a personalized look. The cover features a cut-away bottom design that exposes the filter element to maximize the airflow when installed with a Screamin' Eagle® Stage I Air Cleaner Kit.

Fits '12-later XL1200V and '11-later FLS and FXS models with Original Equipment round air cleaner. Also fits Screamin' Eagle Round Filter Stage Kits P/N 29773-02C, 29000009 and 29000019A.

<b>61300120A</b>	Chrome.	<b>\$54.95</b>
<b>61300128</b>	Gloss Black.	<b>\$54.95</b>



A. BOBBER-STYLE ROUND AIR CLEANER COVER – CHROME



A. BOBBER-STYLE ROUND AIR CLEANER COVER – GLOSS BLACK

### B. SCREAMIN' EAGLE AIR CLEANER RAIN SOCK

Add the open-element look to your Screamin' Eagle Stage-style Air Cleaner. This easy-to-install kit allows you to replace the traditional Original Equipment air cleaner cover with custom inserts from one of the H-D® Decorative Collections. Kit includes a breathable mesh cover with classic Bar & Shield logo that stretches over the filter to maximize airflow while protecting the exposed element from the rain. Fits traditional cone-shaped air cleaner elements featured in many Screamin' Eagle Twin Cam Stage Kits.

<b>28728-10</b>	<b>\$25.95</b>
Fits Screamin' Eagle Air Cleaner Kits P/N 29773-02C, 29260-08, 29000009 and 29000019A.	



B. SCREAMIN' EAGLE AIR CLEANER RAIN SOCK (SHOWN WITH #1 SKULL AIR CLEANER TRIM)



C. SCREAMIN' EAGLE AIR CLEANER INSERT

### C. SCREAMIN' EAGLE® AIR CLEANER INSERT

Dress your factory air cleaner cover with a diamond cut Screamin' Eagle medallion. Lock patch holds the medallion firmly in place and is easy to remove for access to the air cleaner hardware.

<b>61300299</b>	<b>\$19.95</b>
Fits '14-later Touring and Trike models (except CVO™) equipped with Original Equipment air cleaner cover.	

### D. AIR CLEANER COVERS\*

Fits '04-later XL models with Original Equipment Oval Air Cleaner.

<b>29084-10BDK</b>	Primed.	<b>\$74.95</b>
<b>29084-04DH</b>	Vivid Black.	<b>\$94.95</b>

Fits '07 Dyna®, '07-later Softail® (except CVO, FLS, FLSTSB and FXS) and '07-'13 Touring and Trike models.

<b>29585-10BDK</b>	Primed.	<b>\$79.95</b>
<b>29585-07DH</b>	Vivid Black.	<b>\$99.95</b>

Fits '08-later Dyna models with Original Equipment Teardrop Air Cleaner.

<b>29193-10BDK</b>	Primed.	<b>\$79.95</b>
<b>29193-08DH</b>	Vivid Black.	<b>\$99.95</b>



D. AIR CLEANER COVER – '04-LATER SPORTSTER



D. AIR CLEANER COVER – '04-LATER SPORTSTER



D. AIR CLEANER COVER – '07-LATER TWIN CAM



D. AIR CLEANER COVER – DYNA TEARDROP

*Notice: The prices appearing in this catalog are the manufacturer's suggested retail prices. Actual retail prices may vary.*



# ENGINE TRIM 551

Engine & Transmission Covers – Big Twin

NEW



D. NARROW-PROFILE OUTER PRIMARY COVER – CHROME  
(SHOWN WITH DERBY COVER P/N 25700436)

## D. NARROW-PROFILE OUTER PRIMARY COVER

Shaped to slim the bike's profile on the left side, this Narrow Profile Outer Primary Cover clears the way for an easier reach to the ground. The open area provides short-limbed riders a straight leg path to the pavement and simplifies walking the bike into and out of parking spots.

Fits '07-later Touring and Trike models. Installation requires separate purchase of narrow derby cover, derby cover gasket and primary gasket. Chrome is Original Equipment on '15-later FLHTCUL and FLHTKL models.

**25700385** Chrome. **\$349.95**

**25700438** Gloss Black. **\$269.95**

Also available (not shown):

## DERBY COVERS FOR NARROW OUTER PRIMARY COVER

Required for installation of Narrow Profile Outer Primary Covers, these custom derby covers allow you to dress your bike in style.

Fits '15-later FLHTCUL, FLHTKL and '07-later Touring and Trike models equipped with Narrow-Profile Outer Primary Cover P/N 25700385 or 25700438.

**25700388** Classic Chrome. **\$64.95**

**25700437** Gloss Black. **\$49.95**

**25700434** Dark Custom Collection. **\$139.95**

**25700435** Number One Skull Collection **\$139.95**

**25700436** H-D Motor Co. Collection **\$99.95**

NEW



D. NARROW-PROFILE OUTER PRIMARY COVER – GLOSS BLACK  
(SHOWN WITH DERBY COVER P/N 25700437)

Model Family Fitment:

- V-ROD
- SPORTSTER
- DYNA
- SOFTAIL
- TOURING

Notice: The prices appearing in this catalog are the manufacturer's suggested retail prices. Actual retail prices may vary.

# 552 ENGINE TRIM

Engine & Transmission Covers – Big Twin

## A. TWIN CAM ENGINE COVERS – GLOSS BLACK

These engine covers are the perfect start in converting your powertrain to an elegant “tuxedo black” look. Manufactured from Original Equipment components to ensure a perfect fit, these covers are masked and coated with temperature-resistant paint to ensure a long-lasting finish. Complete the look with matching primary covers, rocker housings, rocker covers, cam covers and transmission covers (sold separately).

**25700021A** Primary Cover. **\$269.95**  
Fits '06-later Dyna® models with mid-controls.

**60876-11A** Primary Cover. **\$269.95**  
Fits '07-later Softail® models. Also fits '06-later FLD and Dyna models equipped with factory forward controls. Will not fit with Accessory Forward Controls.

**60886-11A** Primary Cover. **\$269.95**  
Fits '07-later Touring and Trike models (except '15-later FLHTCUL and FLHTKL).

**17707-11** Rocker Box Cover. **\$74.95**  
Fits '99-later Dyna, Touring, Trike and '00-later Softail models (2 required).

**17709-11** Rocker Box Lower Housing. **\$74.95**  
Fits '99-later Dyna, Touring, Trike and '00-later Softail models (2 required).

**37198-11** Cam Cover. **\$139.95**  
Fits '01-later Dyna, Softail and '01-later Touring and Trike models (except '01 EFI Touring).

**37193-11** Transmission Side Cover. **\$64.95**  
Fits '06-later Dyna and '07-later Softail (except FXCW, FXCWC and FXSB) and Touring and Trike models. Does not fit models equipped with a hydraulic clutch.

**25700180** Transmission Side Cover. **\$91.24**  
Fits '13-later Touring and Trike models equipped with hydraulic clutch.

**37195-11** Transmission Top Cover. **\$74.95**  
Fits '06-later Dyna and '07-later Softail, Touring and Trike models.

**25700020** Derby Cover. **\$39.95**  
Fits '06-later Dyna and '07-later Softail, Touring and Trike models (except FLHTCUL, FLHTKL or '07-later Touring or Trike models equipped with Narrow-Profile Outer Primary Cover P/N 25700385 or 25700438).

**25700437** Derby Cover. **\$49.95**  
Fits '15-later FLHTCUL, FLHTKL and '07-later Touring and Trike models equipped with Narrow-Profile Outer Primary Cover P/N 25700385 or 25700438.

NOTE: Removing and installing engine covers may require purchase of new gaskets. See dealer for information.



A. TWIN CAM ENGINE COVERS – GLOSS BLACK

**NEW**



A. TWIN CAM ENGINE COVERS – GLOSS BLACK

Notice: The prices appearing in this catalog are the manufacturer's suggested retail prices. Actual retail prices may vary.



# ENGINE TRIM 553

Engine & Transmission Covers – Big Twin



**B. TWIN CAM ENGINE COVERS – WRINKLE BLACK**

## B. TWIN CAM ENGINE COVERS – WRINKLE BLACK

These black powder-coated engine covers are the perfect start in converting your powertrain to a striking wrinkle black look. Manufactured from Original Equipment components, these covers are masked and painted on the factory production paint line to ensure a matching wrinkle black or texture black finish and a perfect fit. Complete the “blacked-out” look with matching primary covers, rocker housings, rocker covers, cam covers and transmission covers (sold separately).

<b>60758-06A</b>	Primary Cover.	<b>\$269.95</b>
Fits '06-later Dyna® models with mid-controls.		
<b>60717-07A</b>	Primary Cover.	<b>\$239.95</b>
Fits '07-later Softail® models. Also fits '06-later FLD and Dyna models equipped with factory forward controls.		
<b>60706-09A</b>	Primary Cover.	<b>\$269.95</b>
Fits '07-later Touring and Trike models (except '15-later FLHTCUL or FLHTKL).		
<b>60715-99B</b>	Outer Primary Cover.	<b>\$269.95</b>
Fits '99-'05 Dyna and '99-'06 Softail models.		
<b>17620-99</b>	Rocker Box Cover.	<b>\$74.95</b>
Fits '99-later Dyna, Touring, Trike and '00-later Softail models (2 required).		
<b>17618-99A</b>	Rocker Box Lower Housing.	<b>\$74.95</b>
Fits '99-later Dyna, Touring, Trike and '00-later Softail models (2 required).		
<b>25364-01B</b>	Cam Cover.	<b>\$139.95</b>
Fits '01-later Dyna, Softail and '01-later Touring and Trike models (except '01 EFI Touring).		
<b>37135-06</b>	Transmission Side Cover.	<b>\$74.95</b>
Fits '06-later Dyna, '07-later Softail (except FXCW, FXWC and FXSB), and Touring and Trike models. Does not fit models equipped with a hydraulic clutch.		
<b>37189-99</b>	Transmission Side Cover.	<b>\$129.95</b>
Fits '99-'05 Dyna, '00-'06 Softail and '99-'06 Touring models.		
<b>34521-06B</b>	Transmission Top Cover.	<b>\$74.95</b>
Fits '06-later Dyna and '07-later Softail, Touring and Trike models.		
<b>34544-00</b>	Transmission Top Cover.	<b>\$74.95</b>
Fits '00-'06 Softail and '01-'06 Touring models.		
<b>60713-07</b>	Derby Cover.	<b>\$39.95</b>
Fits '06-later Dyna and '07-later Softail, Touring and Trike models (except FLHTCUL, FLHTKL or '07-later Touring or Trike models equipped with Narrow-Profile Outer Primary Cover P/N 25700385 or 25700438).		
<b>60713-99</b>	Derby Cover.	<b>\$39.95</b>
Fits '99-'05 Dyna and '99-'06 Softail and Touring models.		

NOTE: Removing and installing engine covers may require purchase of new gaskets. See dealer for information.



**B. TWIN CAM ENGINE COVERS – WRINKLE BLACK**

### Model Family Fitment:

 V-ROD	 SPORTSTER	 DYNA
 SOFTAIL	 TOURING	

Notice: The prices appearing in this catalog are the manufacturer's suggested retail prices. Actual retail prices may vary.

# 554 ENGINE TRIM

## Engine & Transmission Covers – Twin Cam

### A. CHROME ENGINE KIT – TWIN CAM

Upgrade your silver polished motor to the brilliance of chrome. Kit includes the rocker housing and rocker cover, tappet cover, outer primary, derby cover, cam cover, transmission top and side cover and all necessary gaskets.

**16327-06B** **\$759.95**  
Fits '06-later Dyna® models with mid-controls. Stock on FXDL, FXDC and FXDFSE/2 models.

**16327-01A** **\$759.95**  
Fits '01-'05 Dyna models.

**16318-07B** **\$759.95**  
Fits '07-later Softail® models (except FXCW, FXCWC, FXSB and FXSBSE). Also fits '06-later FLD and Dyna models equipped with factory forward controls.

**16326-07B** **\$759.95**  
Fits '07-later Touring and Trike models. Does not fit models equipped with a hydraulic clutch.

**16326-02** **\$759.95**  
Fits '01-'06 Electra Glide® Standard models.

### B. CHROME ENGINE AND TRANSMISSION COMPONENTS – TWIN CAM-EQUIPPED

Dress the engine of your Twin Cam-equipped model in chrome. These chrome-plated components are manufactured to Original Equipment specifications for exact fit and finish.

#### Chrome Transmission Top Cover

**34469-06B** **\$149.95**  
Fits '06-later Dyna, '07-later Softail and Touring and Trike models.

#### Chrome Transmission Side Covers

**37116-06** **\$129.95**  
Fits '06-later Dyna and '07-later Softail (except FXCW, FXCWC and FXSB), Touring and Trike models. Does not fit models equipped with a hydraulic clutch.

**37105-99** **\$129.95**  
Fits '99-'05 Dyna, '99-'06 Touring and '00-'06 Softail models.

#### Chrome Outer Primary Covers

**60764-06A** **\$349.95**  
Fits '06-later Dyna models (except FXDWG).

**60782-06A** **\$349.95**  
Fits '06-later Dyna Wide Glide® and '07-later Softail models.

**60553-07A** **\$349.95**  
Fits '07-later Touring and Trike models (except FLHTKL and FLHTCUL).

**25700385** **\$349.95**  
Fits '15-later FLHTCUL and FLHTKL models.

**60543-99B** **\$349.95**  
Fits '99-'05 Dyna and '99-'06 Softail models.

**60665-99B** Fits '99-'06 Touring models. **\$349.95**

NOTE: This cover will fit '94-'98 FLT models when used with Clutch Cover P/N 60668-99 and Gasket P/N 25416-99C.

#### Chrome Cam Covers

**25369-01B** **\$174.95**  
Fits '01-later Softail and Dyna, and '01-later Touring and Trike models. (except '01 EFI Touring).

**25247-99** **\$174.95**  
Fits '99-'00 Dyna and Touring, '01 EFI Touring and '00 Softail models.

#### Chrome Transmission Top Covers

**34469-01** Fits '01-'05 Dyna models. **\$149.95**

**34469-99B** Fits '99-'00 Dyna models. **\$229.95**

**34541-00** **\$229.95**

Fits '00-'06 Softail and '01-'06 Touring models.

**34468-98A** **\$229.95**

Fits '98-'99 Softail and '98-'00 Touring models.

#### Chrome Rocker and Tappet Covers

Fits '99-later Dyna, Touring and Trike and '00-later Softail models.

**17572-99** Rocker Cover. **\$114.95**

**17573-99A** Lower Rocker Housing. **\$114.95**

**17964-99** Tappet Cover, Front. **\$39.95**

**17966-99** Tappet Cover, Rear. **\$39.95**



A. CHROME ENGINE KIT – TWIN CAM ('06-LATER DYNA SHOWN)



B. CHROME ENGINE AND TRANSMISSION COMPONENTS – TWIN CAM-EQUIPPED MODELS

Notice: The prices appearing in this catalog are the manufacturer's suggested retail prices. Actual retail prices may vary.



# ENGINE TRIM 555

Engine & Transmission Covers – Twin Cam

## C. CHROME ENGINE AND TRANSMISSION COMPONENTS – EVOLUTION® 1340-EQUIPPED MODELS

**Chrome Transmission Top Cover**  
**34468-98A** \$229.95  
 Fits '98-'99 Softail® and '98-'00 FLT models.

**Chrome Crankcase Gear Covers**  
**25256-93A** \$174.95  
 Fits '93-'99 Evolution® 1340-equipped models.

**25268-84A** \$174.95  
 Fits '84-'92 Evolution 1340-equipped models (4-speed and 5-speed).

**Chrome Outer Primary Covers**  
**60665-85B** \$349.95  
 Fits '85-'88 FXR, FLT, and FLHT models.

**60543-86A** \$349.95  
 Fits '86-'88 FXST, FXSTS, and FLST models.

**60543-89** \$469.95  
 Fits '89-'93 FXST, FXSTS, FLST, and FXD models.

**60665-89** \$349.95  
 Fits '89-'93 FXR, FLT, and FLHT models.

**60543-94** Fits '94 Softail and Dyna® models. \$349.95

**60543-95** Fits '95 Softail and Dyna models. \$349.95

**Chrome Inspection Covers – with Shifter Hole**  
**60667-85A** Fits '85-'94 FXR models. \$39.95

**60529-90A** \$89.95  
 Fits '91-'05 Dyna models (except FXDWG).

**Chrome Inspection Covers – without Shifter Hole**  
**60572-86** \$49.95  
 Fits '93-'05 FXDWG and '86-'06 FXST, FXSTS, and FLST models.

**60670-85A** Fits '85-'06 FLT models. \$54.95

**Chrome Outer Rocker Cover**  
 Sold as separate pieces. Order two per vehicle.  
**17528-92** \$94.95  
 Fits '92-'99 Evolution 1340-equipped models.

**Chrome Rocker Cover Spacer**  
 Sold as separate pieces. Order two per vehicle.  
**17529-92** \$74.95  
 Fits '92-'99 Evolution 1340-equipped models.

**Chrome Lower Rocker Cover**  
 Sold as separate pieces. Order two per vehicle.  
**17530-92** \$129.95  
 Fits '92-'99 Evolution 1340-equipped models.

**Chrome Transmission Side Cover**  
**37105-87A** \$129.95  
 Fits '87-'98 FLT, FLHT, FLHS, FLHR, and Dyna and '87-'99 FXST, FXSTS and FLST models.

## D. CHROME ENGINE KIT – SPORTSTER®

Upgrade your motor with brilliant chrome components. Kit includes chrome gear cover, transmission sprocket cover, primary chain inspection cover, derby cover, inner and outer rocker covers and all gaskets.

**16295-07A** \$949.95  
 Fits '07-later XL models. Stock on '07-later XL1200C, XL1200L, XL1200T, XL1200V and XL 50th Anniversary models.

Model Family Fitment:

- V-ROD
- SPORTSTER
- DYNA
- SOFTAIL
- TOURING

*Notice: The prices appearing in this catalog are the manufacturer's suggested retail prices. Actual retail prices may vary.*



C. CHROME ENGINE AND TRANSMISSION COMPONENTS – EVOLUTION 1340-EQUIPPED MODELS



D. CHROME ENGINE KIT – SPORTSTER

# 556 ENGINE TRIM

Engine & Transmission Covers – Big Twin

## A. INNER PRIMARY COVER – CHROME

Because all components in this cover are exactly like the Original Equipment part, you can be sure this cover will match your outer cover, right down to the high-quality chrome-plating. It completes the look of your powertrain without the hassle of troublesome exchange programs. This cover includes all bearings, dowel pins and seals already installed, to ensure Harley-Davidson quality. Requires separate purchase of model-specific Primary Cover Gasket and O-Ring.

**60792-06C** **\$304.95**  
Fits '06-later FXDWG, FXDSE/2, FXDFSE/2 and '07-later Softail® models (except FXCW, FXCWC, FXSB, FXSBSE and FXSTSSE3). Also fits '08-later FLD and FXDF models with Forward Foot Controls.

**60815-08A** **\$304.95**  
Fits '08-later FXCW, FXCWC, FXSB, FXSBSE and FXSTSSE3 models.

**60639-00** **\$304.95**  
Fits '94-'06 Softail models.

**60794-06C** **\$304.95**  
Fits '06-later Dyna® models (except FLD, FXDWG, FXDSE/2, FXDFSE/2 and FXDF with Forward Foot Controls).

**60751-01** **\$369.95**  
Fits '01-'05 Dyna models (except FXDWG).

**60747-01** **\$369.95**  
Fits '01-'05 FXDWG models.

**60739-07** **\$304.95**  
Fits '07-later Touring and Trike models.

**60739-01** **\$299.95**  
Fits '01-'06 Touring models.



**A. INNER PRIMARY COVER – CHROME  
(TOURING SHOWN)**

## B. INNER PRIMARY COVER TRIM – CHROME

Get the look of a chrome inner primary cover without tearing apart the drive train. Designed to wrap the top surface of the painted inner primary cover, this mirror-chrome die-cast shell provides a beefy finished look to the engine cases. Easy to install, the cover is secured with the outer primary hardware, and held in place at four points for quiet operation. Kit includes required mounting hardware. For a complete custom look, consider adding a Chrome Cylinder Base Cover and Classic Chrome Socket Head Screw Covers (sold separately).

**60849-10** **\$149.95**  
Fits '06-later Dyna models with mid-controls (except FLD).

**60870-10** **\$149.95**  
Fits '06-later Dyna models with forward controls and '12-later FLD models.

**60868-10** **\$149.95**  
Fits '07-later Softail models (except FLSTSC, FXCW, FXCWC, FXSB and FXSBSE). Fits with Original Equipment shift linkage and Polished Shift Linkage P/N 33814-98A.

**60885-10** **\$149.95**  
Fits '09-later Touring and Trike models (except FLHTCUL, FLHTKL or '09-later Touring or Trike models equipped with Narrow-Profile Outer Primary Cover P/N 25700385 or 25700438). Also fits with Chrome Starter Cover P/N 66477-10.

**60869-10** **\$149.95**  
Fits '07-'08 Touring and Trike models (except models equipped with Narrow-Profile Outer Primary Cover P/N 25700385 or 25700438).



**B. INNER PRIMARY COVER TRIM – CHROME  
(TOURING AND TRIKE SHOWN)**

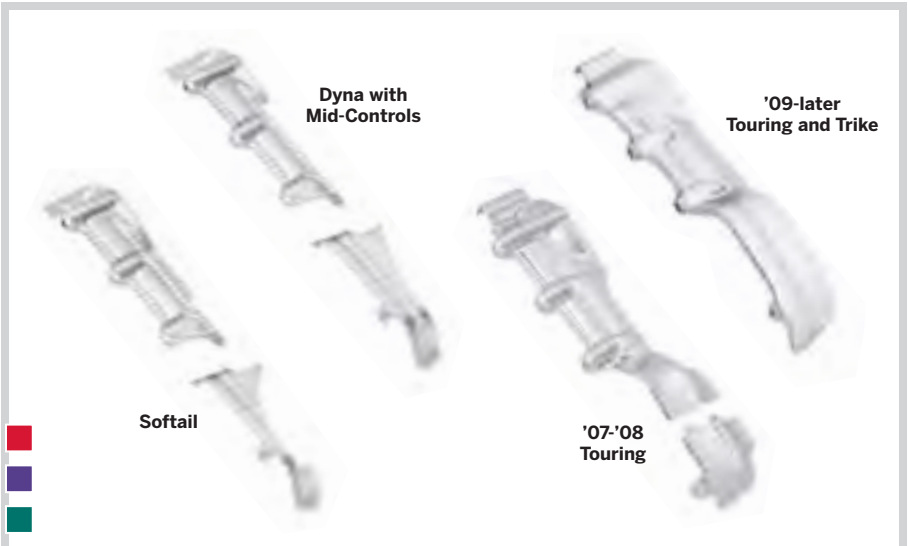

**B. INNER PRIMARY COVER TRIM – CHROME**

*Notice: The prices appearing in this catalog are the manufacturer's suggested retail prices. Actual retail prices may vary.*



# ENGINE TRIM 557

Engine & Transmission Covers – Big Twin



**C. GASKET KIT FOR BLACK INNER PRIMARY – BEFORE**



**C. GASKET KIT FOR BLACK INNER PRIMARY – AFTER**



**C. GASKET KIT FOR BLACK INNER PRIMARY**

**C. GASKET KIT FOR BLACK INNER PRIMARY**

It's the details that count. This gasket kit eliminates the silver shadow line you see between the engine and primary. It's the perfect finishing touch any time the primary has been removed for engine service or during the installation of other accessories. Comprehensive kit contains all gaskets and hardware required to reinstall the primary.

**25700337** **\$61.95**  
Fits '06-later Dyna® and '07-later Softail®, Touring and Trike models.

**D. CYLINDER BASE COVER – SMOOTH**

Add a finished chrome look to the left side of your Twin Cam engine. This easy-to-install kit includes all necessary mounting hardware.

**32042-07** **\$64.95**  
Fits '07-later Softail models. Will not fit CVO™ models and models equipped with 110 cubic inch engines.

**32077-07** **\$64.95**  
Fits '06-later Dyna and '07-later Touring and Trike models. Will not fit CVO models and models equipped with 110 cubic inch engines.

**E. CYLINDER BASE COVER – RIBBED**

Add a finished chrome look to the left side of your Twin Cam engine with this stylish chrome die-cast cover. Easy installation with included hardware. (Shift linkage removed for photo.)

**32753-01** **\$64.95**  
Fits '99-'06 Touring and '99-'05 Dyna models with forward controls, and '00-'06 Softail models. Will not fit with Engine Transmission Top Covers P/N 66505-00, 66510-00 and 66513-00.

**F. RIBBED OIL PUMP COVER**

Finished with flashing chrome, this hand-polished steel cover has a ribbed pattern that matches the transmission covers on '87-'98 Evolution 1340 models. Allows normal check of oil level without removal and includes all necessary hardware and instructions.

**66088-96** **\$84.95**  
Fits '87-'98 FLT, FLHT, FLHS, FLHRC, FLHR and FLTR models.



**D. CYLINDER BASE COVER – SMOOTH**

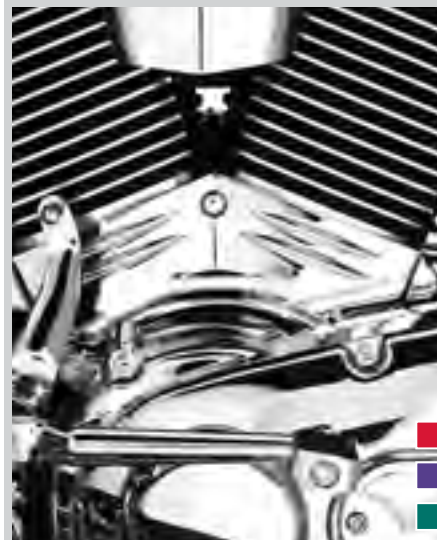

**E. CYLINDER BASE COVER – RIBBED**



**F. RIBBED OIL PUMP COVER**



**Model Family Fitment:**

- V-ROD
- SPORTSTER
- DYNA
- SOFTAIL
- TOURING

*Notice: The prices appearing in this catalog are the manufacturer's suggested retail prices. Actual retail prices may vary.*

# 558 ENGINE TRIM

Engine & Transmission Covers – Big Twin

## A. ENGINE/TRANSMISSION INTERFACE AND TOP COVER KIT

This chrome-plated cover kit dresses the area between the cam cover and transmission, and hugs the transmission for a custom look. The side cover kit conceals the interface hardware, and the contoured top cover fills the valley between the rear cylinder and transmission cover. The kit includes all necessary mounting hardware.

**66516-07** **\$109.95**  
Fits '06-later Dyna® models (except FLD).

**66532-07** **\$109.95**  
Fits '07-'08 Touring models. Will not fit with Chrome Transmission Oil Dipstick P/N 37154-06, or models equipped with hydraulic clutch.



**A. ENGINE/TRANSMISSION INTERFACE AND TOP COVER KIT ('06-LATER DYNA SHOWN)**

## B. ENGINE/TRANSMISSION INTERFACE COVER

Featuring a ribbed design for sharp surface contrasts, this chrome Engine/Transmission Interface Cover provides a custom option to conceal the space between the cam cover and the transmission. The cover stretches from the gearcase cover to the rear of the transmission, and frames the transmission side cover with a band of chrome for a complete custom look. Kit includes all necessary mounting hardware.

**66543-08** **\$99.95**  
Fits '07-later Softail® models (except FLSTNSE, FLSTSC, FXCW, FXCWC, FXSB and FXSBSE). Does not fit models equipped with hydraulic clutch.



**A. ENGINE/TRANSMISSION INTERFACE AND TOP COVER KIT ('07-'08 TOURING SHOWN)**

## C. CAST ENGINE/TRANSMISSION INTERFACE COVER

Bridge the space between the cam cover and the transmission in style. The cast and chrome-plated cover conceals the space between the transmission and gearcase cover, bringing a unified look to the right side of your Touring bike. Kit includes all necessary mounting hardware.

**66545-07** **\$64.95**  
Fits '07-'08 Touring models. Will not fit models equipped with hydraulic clutch.

**66530-03** **\$99.95**  
Fits '02-'06 Touring models. Will not fit with Lifter Block Cover P/N 18248-99, models equipped with hydraulic clutch or Screamin' Eagle® Six Speed Transmission.



**B. ENGINE/TRANSMISSION INTERFACE COVER**

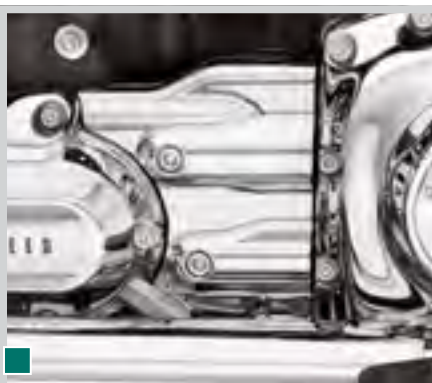

**C. CAST ENGINE/TRANSMISSION INTERFACE COVER ('07-'08 TOURING SHOWN)**

**C. CAST ENGINE/TRANSMISSION INTERFACE COVER ('02-'06 TOURING SHOWN)**

*Notice: The prices appearing in this catalog are the manufacturer's suggested retail prices. Actual retail prices may vary.*



# ENGINE TRIM 559

## Engine & Transmission Covers – Big Twin



**D. TAPPET BLOCK ACCENT**



**D. TAPPET BLOCK ACCENT**

Shaped to fill the gap between the tappet blocks, this unique cover adds a splash of chrome to the profile of your engine. The die-cast cover is polished and chrome-plated to a mirror finish. Easy to install.

**61400002** **\$69.95**

Fits '99-later Twin Cam-equipped models. Does not fit with Lifter Block Covers P/N 18248-99, 18278-06 and 18262-00 or Billet Lifter Cover P/N 18088-02.

**E. LIFTER BLOCK COVER**

Unlike other lifter block covers on the market, this chrome-plated cover features a design that helps hide the mounting hardware. With an embossed Bar & Shield logo, this kit cleans up the lifter block area and extends chrome from the gearcase cover to the lifter tubes. Includes all mounting hardware and installation tools.

**18248-99** **\$64.95**

Fits '99-'06 Touring and '99-'05 Dyna® models. Does not fit with Top Covers P/N 66513-00 or 66505-00, Oil Hose Cover P/N 37961-02 or Interface Cover P/N 66530-03.

**18278-06** **\$64.95**

Fits '06-later Dyna and '07-later Touring and Trike models.

**18262-00** **\$64.95**

Fits '00-later Twin Cam Softail® models. (Will not fit with Engine/Transmission Interface Top Cover P/N 66510-00.)

**F. BILLET ALUMINUM LIFTER COVERS – CHROME**

Manufactured from billet aluminum and polished and plated for a rich look, these Chrome Billet Aluminum Lifter Covers add a custom look to Twin Cam-equipped models. Unique styling matches H-D® Chrome Pushrod Cover Kit, and fits with stock or Screamin' Eagle® Quick-Install Pushrods. Kit includes chrome mounting hardware and gaskets to complete the installation.

**18088-02** **\$129.95**

Fits '99-later Twin Cam-equipped models (except models equipped with 110 cubic inch engines).

**G. PUSHROD COVER KIT – CHROME**

These covers feature a unique look courtesy of a special grooved design and superior quality, thanks to a crafted combination billet 6061-T6 aluminum finished with copper-, dual nickel- and chrome-plating. Can be used with Original Equipment pushrods or Screamin' Eagle Adjustable Pushrods.

**18096-00A** **\$174.95**

Fits '99-later Twin Cam-equipped models.

**H. PUSHROD COVER KIT – GLOSS BLACK**

Complete the Dark Custom look. These covers replace existing chrome covers to give your bike a blacked-out appearance down to the smallest detail. Pushrod covers are finished in a gloss black and include the four bottom cover tubes and the four upper clips. Installation retains the Original Equipment chrome short center tube to create a high-contrast accent. Cover Kit can be installed on engines already equipped with Adjustable Pushrods or can be installed by removing rocker box covers, rocker arms and non-adjustable pushrods. Consult your dealer or service manual for installation.

**17900033** Covers Only. **\$64.95**

Fits '99-later Twin Cam-equipped models. Requires prior installation of Adjustable Pushrods or removal of rocker box covers, rocker arms and fixed-length pushrods.



**E. LIFTER BLOCK COVER**



**F. BILLET ALUMINUM LIFTER COVERS – CHROME**



**G. PUSHROD COVER KIT – CHROME**



**H. PUSHROD COVER KIT – GLOSS BLACK**

**Model Family Fitment:**

- V-ROD
- SPORTSTER
- DYNA
- SOFTAIL
- TOURING

*Notice: The prices appearing in this catalog are the manufacturer's suggested retail prices. Actual retail prices may vary.*

# 560 ENGINE TRIM

Engine & Transmission Covers – Big Twin

## A. STARTER COVER – CHROME

With the under-chassis exhaust crossover on the late model Touring bikes, the painted starter motor is now easily seen from both sides of the bike. This brilliantly chrome-plated cover conceals the starter motor and starter solenoid for a clean, custom look. Easy to install, this kit includes all required mounting hardware.

**66477-10** **\$69.95**  
Fits '09-later Touring and Trike models (except CVO™ and models with High Output Starter P/N 31621-06A or 31619-06A).



A. STARTER COVER – CHROME

## B. BILLET FRONT ENGINE MOUNT BRACKET

A must-have for any chrome connoisseur, this chrome-plated Front Engine Mount Bracket will set your custom apart from the rest. The chrome bracket is machined from premium 6061-T6 aluminum, and is a direct bolt-on replacement for the Original Equipment bracket. Can be used with the stock stabilizer link, or dressed up with the optional chrome Front Engine Mount Stabilizer Link P/N 16213-10. Kit includes chrome mounting hardware.

**16205-10** **\$129.95**  
Fits '08-later Touring models.



B. BILLET FRONT ENGINE MOUNT BRACKET

## C. FRONT ENGINE MOUNT STABILIZER LINK

Add a custom style to the front end with this brilliant chrome-plated Engine Mount Stabilizer Link. This custom heim joint assembly complements the chrome Billet Front Engine Mount Bracket P/N 16205-10. Kit includes chrome mounting hardware.

**16213-10** **\$49.95**  
Fits '09-later Touring and Trike models.



C. FRONT ENGINE MOUNT STABILIZER LINK

## D. STARTER SOLENOID COVER KIT – CHROME

Add chrome to an often overlooked area with this cover, featuring the same high-quality, bright finish used on most of our accessories.

**31783-00** **\$21.95**  
Fits '94-later models (except '02-later VRSC™ and '15-later XG).



D. STARTER SOLENOID COVER KIT – CHROME

## E. HARLEY-DAVIDSON® GENUINE HIGH PERFORMANCE 1.4KW STARTER

This starter offers both great styling and increased performance, providing 15% greater torque than the stock replacement starter. Engineered and tested by Harley-Davidson from the ground up, this starter offers unparalleled reliability and durability. No special battery or battery cable requirements.

Fits '06-later Dyna® (except ABS equipped models) and '07-later Softail®, Touring and Trike models.

**31619-06A** Black Finish. **\$429.95**

**31621-06A** Chrome Finish. **\$529.95**

Fits '94-'06 Softail and Touring, '94-'05 Dyna and '99-'00 FXR models.

**31335-03A** Black Finish. **\$429.95**

**31559-99A** Chrome Finish. **\$529.95**



E. HARLEY-DAVIDSON GENUINE HIGH PERFORMANCE 1.4KW STARTER – CHROME

Notice: The prices appearing in this catalog are the manufacturer's suggested retail prices. Actual retail prices may vary.



# ENGINE TRIM 561

## Engine & Transmission Covers – Big Twin



F. THROTTLE BODY COVER



### F. THROTTLE BODY COVER

This cover dresses the area between the Twin Cam cylinders for a custom look. The formed cover hugs the contour and conceals the electronic control module throttle body for a clean appearance. Available in your choice of mirror-chrome or gloss black finish. Easy-to-install kit includes gaskets.

Fits '11-'12 FLSTSE2/3, '13-later FXSBSE, '14-'15 FLSTNSE and '08-later Touring and Trike models equipped with Screamin' Eagle® Heavy Breather or Burst Collection Air Cleaner Kit.

<b>61300109</b>	Chrome.	<b>\$59.95</b>
<b>61300110</b>	Gloss Black.	<b>\$59.95</b>

### G. EFI INTAKE MANIFOLD COVER

Add a finishing touch to your Original Equipment or custom air cleaner. This mirror-polished chrome cover conceals the sensors, plugs and wires on the intake manifold, and adds a splash of chrome below the fuel tank.

**27483-07A** **\$41.95**

Fits '04-later Dyna®, '01-later Softail® and '02-'07 Touring models with Electronic Fuel Injection. Does not fit HDI models.



G. EFI INTAKE MANIFOLD COVER



### H. OIL FILLER SPOUT – CHROME

Add more chrome to the side of your transmission with this chrome-plated version of the stock oil filler spout. Made from the Original Equipment component to ensure product quality and fitment. Kit includes new replacement gasket and chrome hardware.

**62470-02** **\$89.95**

Fits '99-'06 FLHT, FLHR and FLTR models. Also fits '93-'98 Evolution® 1340-equipped models without Oil Temperature Dipstick with Lighted LCD Readout P/N 62936-00B.

### I. OIL VENT LINE – CHROME

Add a final detail to your Touring model with this Chrome Oil Vent Line, constructed from steel tubing that's polished and chrome-plated for a brilliant finish. Kit includes polished and chrome-plated compression fittings, and installs easily for a custom look.

**33111-02** **\$54.95**

Fits '02-'06 Touring models. Also fits '99-'06 Touring models equipped with Oil Filler Spout P/N 62470-02, 62453-02 or 62454-02A.



H. OIL FILLER SPOUT – CHROME



I. OIL VENT LINE – CHROME

### J. OIL HOSE COVER – CHROME

Add some chrome to the Twin Cam with this polished and chrome-plated Oil Hose Cover. We start with the Original Equipment cover to ensure correct fitment and product integrity, then polish and chrome-plate it to the high standards you've come to expect from Genuine Motor Accessories. Includes chrome-plated mounting hardware.

**37946-99** **\$64.95**

Fits '99-'06 Touring models. (Does not fit with Twin Cam Premium Oil Cooler for Touring Models P/N 62868-99 or Oil Temperature Gauge Kit P/N 75265-04 or 74513-04.)

### K. OIL FILTER BRACKET – CHROME

This highly-polished, triple chrome-plated bracket looks great against a blacked-out engine. To ensure proper fitment, it's made from the same Original Equipment aluminum die-casting. Includes chrome mounting hardware and new seals.

**26321-99A** **\$69.95**

Fits '99-'06 Touring and '99-'05 Dyna models.



J. OIL HOSE COVER – CHROME



K. OIL FILTER BRACKET – CHROME

#### Model Family Fitment:

V-ROD	SPORTSTER	DYNA
SOFTAIL	TOURING	

Notice: The prices appearing in this catalog are the manufacturer's suggested retail prices. Actual retail prices may vary.

# 562 ENGINE TRIM

Engine & Transmission Covers – Big Twin

## A. WATER PUMP COVER – CHROME

Dress the Twin-Cooled™ Touring model's Water Pump Cover in style. This Chrome Water Pump is designed to hug the contours of the water pump, and conceals many of the coolant lines and fittings for a custom look. A direct replacement for the Original Equipment black plastic cover, this kit can be installed in minutes.

**61400225** **\$74.95**  
Fits '14-later FLHTCU, FLHTCUL, FLHTK, FLHTKL, FLHTKSE, FLTRUSE and FLHTCUTG models equipped with Twin-Cooled engines.



A. WATER PUMP COVER – CHROME

## B. CLUTCH CABLE CONNECTOR COVER

Add the finishing touch to your transmission. This chrome-plated die-cast cover conceals the clutch cable connector as it enters the primary cover. The two-piece grooved and tapered cover is easy to install, and includes chrome-plated mounting hardware.

**33401-05** **\$29.95**  
Fits '00-later XL and XR models with cable operated clutch.

**38636-07** **\$26.95**  
Fits '06-later Dyna®, '07-later Softail®, Touring and Trike models (except models equipped with hydraulic clutch). Does not fit with braided or Diamondback™ clutch cables.

**32875-04** **\$28.95**  
Fits '99-'06 Touring, '00-'06 Softail and '99-'05 Dyna models, (except models equipped with hydraulic clutch). Does not fit with braided or Diamondback clutch cables.



B. CLUTCH CABLE CONNECTOR COVER

## C. FUEL TANK FITTING COVER

This classic chrome styled two piece die-cast cover conceals the EFI fuel line fitting below the tank. Easy to install, the kit includes chrome-plated hardware and hex key wrench.

**62809-06** **\$31.95**  
Fits '03-later fuel injected Touring and Trike, '02-later fuel injected Softail, and '04-'07 fuel injected Dyna models.



## D. BRAIDED STAINLESS STEEL EFI FUEL LINE

Add a finishing touch to the fuel-injected Dyna with this Braided Stainless Steel Fuel Line. Complete replacement line includes pre-installed fuel tank and EFI module connectors.

**63020-04** **\$39.95**  
Fits '04-'05 fuel injected Dyna models.

## E. BRAIDED STAINLESS STEEL FUEL CROSSOVER LINE

A beautifully Braided Stainless Steel Fuel Line accented with highly polished chrome fittings for your front fuel tank crossover. Innovative fittings are designed to eliminate unsightly hose clamps.

**63709-04** **\$37.95**  
Fits '04-later Dyna models (except FXDWG, '06 FXD35, '07-later FXDC and '08-later FXDF models).

**63729-04** **\$37.95**  
Fits '04-later FXDWG, '06 FXD35, '07-later FXDC, '08-later FXDF, and FXDFSE/2 models.

**63690-00A** Fits '93-'03 Dyna models. **\$37.95**

**63698-02** Fits '97-'07 Touring models. **\$37.95**

**63692-00A** Fits '00-later Softail models (except FXSTD, FXCW and FXCWC). **\$37.95**

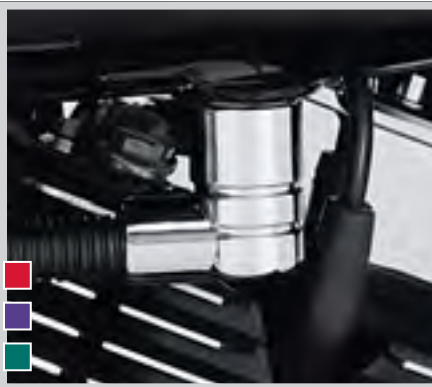

C. FUEL TANK FITTING COVER



D. BRAIDED STAINLESS STEEL EFI FUEL LINE

E. BRAIDED STAINLESS STEEL FUEL CROSSOVER LINE

Notice: The prices appearing in this catalog are the manufacturer's suggested retail prices. Actual retail prices may vary.



# ENGINE TRIM 563

Engine & Transmission Covers – Big Twin



**F. BILLET OIL LINE SEPARATOR**



**G. NEUTRAL SWITCH COVER – CHROME**

**F. BILLET OIL LINE SEPARATOR**

This chrome-plated billet aluminum clamp holds the Original Equipment oil lines in position for a clean, custom appearance. Complete kit is easy to install, and includes chrome-plated hardware.

**91333-06** **\$29.95**  
 Fits '00-later Softail® models (except FXCW, FXCWC, FXSB, FXSBSE and FXSTSSE3) with Original Equipment oil lines.

**G. NEUTRAL SWITCH COVER – CHROME**

Add a final custom detail to your chrome transmission cover with this Chrome Neutral Switch Cover. It installs easily and comes with installation hardware.

**33919-00** **\$25.95**  
 Fits '98-'05 Dyna® and '98-'06 Touring models.

**H. ENRICHENER/CHOKE KNOB COVER**

A subtle chrome touch that can make all the difference, this cover features the Bar & Shield logo and can be installed in minutes.

**29431-97** **\$29.95**  
 Fits '86-'06 carbureted models.

**I. FUEL PETCOCK COVER**

This cover offers unique styling, with chrome plating and a "Harley-Davidson Motor Co." logo. Cover is notched for position identification.

**62968-02** **\$34.95**  
 Fits '02-'06 carbureted models.

**J. SCREAMIN' EAGLE® CV CARBURETOR TOP COVER**

This great looking carb top adds a finishing touch to the Original Equipment or Screamin' Eagle® 44mm CV carburetor. The die-cast top features a brilliant chrome finish and "Screamin' Eagle" diamond engraving for clean crisp detail.

**27477-04** **\$27.95**  
 Fits carbureted models equipped with Original Equipment or Screamin' Eagle Big Bore 44mm CV carburetor.

**K. CV CARBURETOR TOP COVER**

Die-cast and chrome-plated cover with chrome-plated mounting hardware.

Fits '88-'06 XL, '90-'00 Evolution® 1340 and '99-'06 Twin Cam-equipped models with CV carburetors. Works with Screamin' Eagle 44mm CV Carburetor Kit P/N 27934-99. (Does not fit fuel injected models.)

<b>27040-88T</b>	Bar & Shield – Chrome.	<b>\$24.95</b>
<b>27351-96</b>	H-D Motor Co. – Chrome.	<b>\$25.95</b>
<b>27353-96</b>	Classic Chrome.	<b>\$24.95</b>
<b>27129-88T</b>	Replacement Chrome Screw.	<b>\$0.95</b>



**H. ENRICHENER/CHOKE KNOB COVER**



**I. FUEL PETCOCK COVER**



**J. SCREAMIN' EAGLE CV CARBURETOR TOP COVER**



**K. CV CARBURETOR TOP COVER – BAR & SHIELD**



**K. CV CARBURETOR TOP COVER – H-D MOTOR CO.**



**K. CV CARBURETOR TOP COVER – CLASSIC CHROME**

**Model Family Fitment:**

<span style="display: inline-block; width: 10px; height: 10px; background-color: gray; border: 1px solid black;"></span> V-ROD	<span style="display: inline-block; width: 10px; height: 10px; background-color: yellow; border: 1px solid black;"></span> SPORTSTER	<span style="display: inline-block; width: 10px; height: 10px; background-color: red; border: 1px solid black;"></span> DYNA
<span style="display: inline-block; width: 10px; height: 10px; background-color: purple; border: 1px solid black;"></span> SOFTAIL	<span style="display: inline-block; width: 10px; height: 10px; background-color: teal; border: 1px solid black;"></span> TOURING	

*Notice: The prices appearing in this catalog are the manufacturer's suggested retail prices. Actual retail prices may vary.*

# 564 ENGINE TRIM

## Oil Coolers – Big Twin

### PREMIUM OIL COOLER KITS

This oil cooler was designed specifically for Harley-Davidson® to out-perform all other coolers in the industry. The cooler features a unique "Turbulator" system that evenly distributes oil across the cooling chambers. The air fins are designed to efficiently dissipate heat. The oil cooler has been designed to simplify installation and enhance performance. The large heat exchanger provides excellent cooling efficiency. The kit features a one-piece adapter plate with integrated thermostat that allows oil lines to connect to the oil filter bracket. Thermostat activates at 185°F (85°C). Kit comes complete with mounting hardware and precut oil lines.

**Inside View of Premium Oil Cooler with Turbulators**

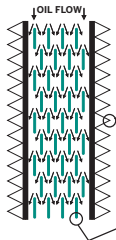

**Inside View of Conventional Oil Cooler without Turbulators**

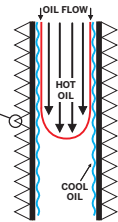

Turbulators disperse and mix oil inside cooler to provide more efficient cooling capabilities. The cooler oil is not allowed to remain along the boundaries of the flow tube as in conventional coolers.

Coolers without the Turbulator system allow oil to flow only in a straight path. Oil does not mix and the cooler oil remains along the outer boundaries, while the hotter oil remains along the center path of flow. Without the mixing effects of the Turbulators, the conventional oil cooler provides less efficient cooling capabilities.

### A. PREMIUM OIL COOLER KIT – DYNA® MODELS

**26151-07** Horizontal Mount. **\$329.95**  
Fits '06-later Dyna® models (except FLD, FXDSE/2, FXDFSE/2 and California models). Does not fit with Front Spoiler Kits or DEFINITIVE5™ Filtration System Kits. Fits with all H-D® Engine Guards. Includes chrome oil cooler cover.

**62700017A** Side Mount. **\$329.95**  
Fits '07-later Dyna models. Fits with all H-D Engine Guards. Includes gloss black Oil Cooler Cover.

### B. PREMIUM OIL COOLER KIT – SOFTAIL® MODELS

**26157-07A** Center Mount. **\$329.95**  
Fits '13-later FXSBSE with or without ABS and '00-later Softail models (except FXSB) without ABS. Does not fit '11 FXCWC. '08-'10 FXCW and FXCWC models require separate purchase of Horn Relocation Kit for Oil Cooler P/N 69015-08. Does not fit with Softail® Front Spoiler Kits, or Definitive5 Filtration System Kits. Fits with all H-D Engine Guards. Includes Chrome Oil Cooler Cover.

**26157-11A** Side Mount. **\$329.95**  
Fits '11-later Softail models. Fits with all H-D Engine Guards. Kit includes Gloss Black Oil Cooler Cover.

#### Also available:

#### HORN RELOCATION KIT

Required when installing Oil Cooler Kit P/N 26157-07 on FXCW and FXCWC models.

**69015-08** **\$12.95**  
Fits '08-'10 FXCW and FXCWC models equipped with Oil Cooler Kit P/N 26157-07.



**A. PREMIUM OIL COOLER KIT – DYNA HORIZONTAL MOUNT**



**A. PREMIUM OIL COOLER KIT – DYNA SIDE MOUNT**



**B. PREMIUM OIL COOLER KIT – '00-LATER SOFTAIL WITHOUT ABS CENTER MOUNT**

**B. PREMIUM OIL COOLER KIT – '11-LATER SOFTAIL WITH ABS SIDE MOUNT**

*Notice: The prices appearing in this catalog are the manufacturer's suggested retail prices. Actual retail prices may vary.*



# ENGINE TRIM 565

Oil Coolers – Big Twin



**C. PREMIUM OIL COOLER KIT – '09-'10 TOURING**



## C. PREMIUM OIL COOLER KIT – TOURING MODELS

**26155-09A** Horizontal Mount. **\$329.95**

Fits '09-'10 Touring models. Stock on '09-'10 FLTRSE3, FLHXSE/2 and FLHTCUSE4/5/6. Does not fit with Voltage Regulator Cover P/N 74538-09, DEFINITIVE5™ Filtration System Kit or models equipped with a sidecar.

**26155-07A** Horizontal Mount. **\$329.95**

Fits '07-'08 Touring models. Stock on '07-'08 FLHTCUSE2/3. Does not fit with Chrome Display Stand P/N 99002-97A, Voltage Regulator Cover P/N 74538-09, DEFINITIVE5 Filtration System Kit or models equipped with a sidecar.

**26082-05C** Horizontal Mount. **\$329.95**

Fits '99-'06 Touring models. Does not fit with Chrome Display Stand P/N 99002-97A, Voltage Regulator Cover P/N 74538-09, DEFINITIVE5 Filtration System Kit or models equipped with a sidecar.

## D. OIL COOLER COVER KIT – TOURING

Dress the Touring Oil Cooler in style. This Chrome Oil Cooler Cover is designed to hug the contours of the cooler body while allowing complete airflow across the surface. Includes required mounting hardware.

**63121-11A** **\$59.95**

Fits '11-later Touring and Trike models (except models equipped with Twin-Cooled™ engines).

**25700007** **\$59.95**

Fits '09-'10 Touring and Trike models.

**62995-04** **\$59.95**

Fits '99-'06 Touring models equipped with Touring Oil Cooler Kit P/N 62895-03A.



**C. PREMIUM OIL COOLER – '07-'08 TOURING**



**C. PREMIUM OIL COOLER – '99-'06 TOURING**



**D. OIL COOLER COVER KIT – '09-'10 TOURING**



**D. OIL COOLER COVER KIT – '11-LATER TOURING**

### Model Family Fitment:

- V-ROD
- SPORTSTER
- DYNA
- SOFTAIL
- TOURING

*Notice: The prices appearing in this catalog are the manufacturer's suggested retail prices. Actual retail prices may vary.*

# 566 ENGINE TRIM

## Oil Level Dipsticks

### A. OIL LEVEL AND TEMPERATURE DIPSTICK WITH LIGHTED LCD READOUT

No more grabbing a rag to pull your hot dipstick. No more oil drips on your pipes and on the garage floor. These stylish yet hard-working dipsticks allow you to check your oil level and oil temperature with the push of a button. Simply push the button and this dipstick lights up with a brilliant backlight. Oil level is indicated by a four-segment readout — it even reminds you to check your oil when it is hot. Capacitive level sensing technology provides the highest degree of accuracy and durability. The waterproof LCD readout operates on a long-lasting, replaceable lithium coin-type battery (CR2032 3V, P/N 66000107). Display features a low battery indicator, and press-and-hold feature to toggle between Fahrenheit and Celsius.

Fits '07-later Touring models (except models equipped with a sidecar). Will not fit Touring models equipped with Engine/Transmission Interface Cover P/N 66532-07.

<b>63004-09</b>	Chrome.	<b>\$149.95</b>
<b>63030-09</b>	Gloss Black.	<b>\$149.95</b>

Fits '09-later Trike models. Also fits '09-later Touring models equipped with a sidecar.

<b>62700005</b>	Chrome.	<b>\$149.95</b>
-----------------	---------	-----------------

Fits '02-'06 Touring models (except models equipped with a sidecar). Also fits '99-'01 Touring models equipped with Chrome Oil Filler Spout P/N 62470-02, 62453-02 or 62454-02A.

<b>62946-09</b>	Chrome.	<b>\$149.95</b>
-----------------	---------	-----------------

Fits '00-later Softail® models (except FXCW, FXCWC, FXSB, FXSBSE and FXSTSSE3).

<b>62955-09</b>	Chrome.	<b>\$149.95</b>
<b>63055-09</b>	Gloss Black.	<b>\$149.95</b>

Fits '08-later FXCW, FXCWC, FXSB, FXSBSE and FXSTSSE3 models.

<b>63002-09</b>	Chrome.	<b>\$149.95</b>
-----------------	---------	-----------------

Fits '06-later Dyna® models (except FLD).

<b>62974-09</b>	Chrome.	<b>\$149.95</b>
<b>63065-09</b>	Gloss Black.	<b>\$149.95</b>



A. OIL LEVEL AND TEMPERATURE DIPSTICK – CHROME (DYNA SHOWN)



A. OIL LEVEL AND TEMPERATURE DIPSTICK – GLOSS BLACK (DYNA SHOWN)



A. OIL LEVEL AND TEMPERATURE DIPSTICK – CHROME (SOFTAIL SHOWN)



A. OIL LEVEL AND TEMPERATURE DIPSTICK – GLOSS BLACK (SOFTAIL SHOWN)



A. OIL LEVEL AND TEMPERATURE DIPSTICK – CHROME (TOURING SHOWN)



A. OIL LEVEL AND TEMPERATURE DIPSTICK – GLOSS BLACK (TOURING SHOWN)

Notice: The prices appearing in this catalog are the manufacturer's suggested retail prices. Actual retail prices may vary.



# ENGINE TRIM 567

Oil Level Dipsticks



**B. OIL TEMPERATURE DIPSTICK WITH LIGHTED LCD READOUT**



**C. CHROME OIL DIPSTICK – '99-'06 TOURING**



**C. OIL DIPSTICK – '06-LATER DYNA**



**D. OIL DIPSTICK WITH TEMPERATURE GAUGE**

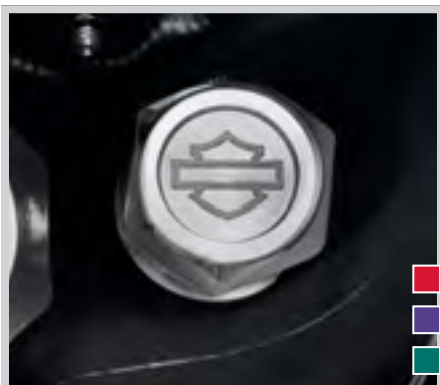

**E. SPEED-CHECK TRANSMISSION DIPSTICK – (37103-08 SHOWN)**



**B. OIL TEMPERATURE DIPSTICK WITH LIGHTED LCD READOUT**

Add function and style by replacing your stock dipstick with this hardworking version, which includes a beautiful chrome cap and LCD (liquid crystal display) oil temperature readout. The readout is push-button operated with an automatic shut-off after five seconds and operates within plus or minus one degree. Fahrenheit or Celsius can be changed with a simple push button operation. The readout is displayed with a rare blue light background for easier operation at night. All LCD dipsticks now incorporate an updated and more heat resistant LCD electronic unit. Twin Cam LCD dipsticks also include an improved twist and pull cam-lock removal feature. Designed to be waterproof with replaceable lithium battery.

**62938-00E** Fits '99-'05 Dyna® models. **\$109.95**  
**66000107** **\$3.95**  
 CR2032 3V Lithium Replacement Battery.

**C. CHROME OIL DIPSTICK**

Easy-to-install chrome-plated oil dipstick adds a finishing touch and shows your attention to detail.

**62858-99** Fits '99-'06 Touring models. **\$39.95**  
**62692-07** Fits '06-later Dyna models. **\$51.95**

**D. OIL DIPSTICK WITH TEMPERATURE GAUGE**

Replace your Original Equipment oil dipstick with this custom-styled version featuring an easy-to-see mechanical temperature readout with "Harley-Davidson" logo. A chrome-plated cap completes the styling and provides an easy grip for removal.

**62896-00B** **\$39.95**  
 Fits '00-later Softail® models (except FXCW, FXCWC, FXSB, FXSBSE and FXSTSSE3).  
**62668-87TA** Fits '84-'99 Softail models. **\$34.95**

**E. SPEED-CHECK TRANSMISSION DIPSTICK**

This decorative and functional dipstick is hand-operated, eliminating the need for a wrench. It has a Bar & Shield logo and is easy to install.

**37103-08** **\$29.95**  
 Fits '06-later Dyna (except models with ABS) and '07-later Softail, Touring and Trike models. Will not fit Touring models equipped with Engine/Transmission Interface Cover P/N 66532-07.  
**37123-98A** **\$24.95**  
 Fits '87-'99 Evolution® 1340-equipped models, '99-'06 Touring, '00-'06 Softail and '99-'05 Dyna models. (Does not fit with Oil Pump Cover P/N 66394-93 and 66088-96, Interface Cover P/N 66508-00, or models equipped with hydraulic clutch.)

**Model Family Fitment:**

- V-ROD
- SPORTSTER
- DYNA
- SOFTAIL
- TOURING

*Notice: The prices appearing in this catalog are the manufacturer's suggested retail prices. Actual retail prices may vary.*

# 568 ENGINE TRIM

## Cylinder Head Covers

### A. FINNED HEADBOLT BRIDGE

This exclusive aluminum Finned Headbolt Bridge covers both headbolts and the spark plug, filling out your cylinder fins all the way to the rocker box. Featuring an engraved Bar & Shield emblem, the bridge is easy to install with unique headbolt mounts. All necessary mounting hardware included. Sold in pairs.

**43859-00** Black Highlighted. **\$59.95**  
Fits '99-later Twin Cam-equipped models with electronic fuel injection and '00-later FXSTD models.

**43841-01** Black Highlighted. **\$59.95**  
Fits '99-'06 carbureted Twin Cam-equipped models.

**43857-00** Silver Highlighted. **\$59.95**  
Fits '99-later Twin Cam-equipped models with electronic fuel injection and '00-later FXSTD models.

**43840-01** Silver Highlighted. **\$59.95**  
Fits '99-'06 carbureted Twin Cam-equipped models.

**61400148** CVO™ Granite Highlighted. **\$59.95**  
Fits '99-later Twin Cam-equipped models with electronic fuel injection and '00-later FXSTD models.

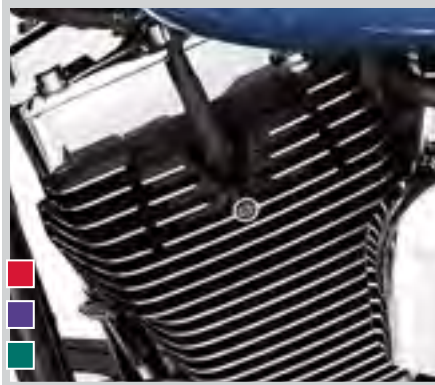

A. FINNED HEADBOLT BRIDGE – BLACK HIGHLIGHTED

### B. HEADBOLT BRIDGE – CHROME

This exclusive Headbolt Bridge covers both the headbolts and spark plug with a splash of chrome and an engraved Bar & Shield emblem. Easy to install with unique headbolt mounts. Kit includes all necessary mounting hardware. Sold in pairs.

**43858-00** **\$59.95**  
Fits '99-later Twin Cam-equipped models. (Will not fit with SE heads or SE 110CI engines.)



A. FINNED HEADBOLT BRIDGE – SILVER HIGHLIGHTED

A. FINNED HEADBOLT BRIDGE – CVO GRANITE HIGHLIGHTED

### C. SPARK PLUG/HEADBOLT COVER – CHROME

Quickly add a chrome accent from the headbolt covers to the spark plug. Installs in seconds without tools.

**43835-98** **\$59.95**  
Fits '84-'99 Evolution® 1340-equipped models and '85-'03 XL models. (Does not fit Screamin' Eagle® Evolution Heads.)



B. HEADBOLT BRIDGE – CHROME



C. SPARK PLUG/HEADBOLT COVER – CHROME

*Notice: The prices appearing in this catalog are the manufacturer's suggested retail prices. Actual retail prices may vary.*



# ENGINE TRIM 569

Cylinder Head Covers



**D. CLASSIC CHROME SPARK PLUG COVER**



**E. H-D MOTOR CO. LOGO SPARK PLUG COVER**

**D. CLASSIC CHROME SPARK PLUG COVER**

Quickly slips over spark plug for a secure fit.

**32747-99**

**\$20.95**

Fits '99-later Twin Cam-equipped models.

**E. H-D® MOTOR CO. LOGO SPARK PLUG COVER**

Quickly slips over spark plugs for a secure fit.

**32745-99**

**\$20.95**

Fits '99-later Twin Cam-equipped models.

**F. HEADBOLT COVERS**

Precision-machined of high-quality aluminum and manufactured in the U.S.A. Hand-polished and chrome-plated. Available in a variety of styles to match your customizing direction, these kits include 4 easy-to-install headbolt covers, set screws and an Allen® wrench for easy installation.

Fits '86-later XL, '08-'13 XR, '85-'99 Evolution® 1340 and '99-later Twin Cam models.

**43822-01** Chrome-Billet. **\$42.95**

**43890-93** Chrome-Die Cast. **\$38.95**

**43896-99** Gloss Black. **\$41.95**

**43911-95** Chrome Bar & Shield Logo. **\$38.95**

**43884-96** Chrome H-D® Motor Co. Logo **\$38.95**

**G. CLASSIC CHROME ROCKER BOX BOLT COVERS**

Matching the styling of our classic chrome headbolt covers, these chrome-plated Rocker Box Bolt Covers add chrome to your engine. Easy to install, the covers are held in place by a spring steel clip.

**43868-99** **\$25.95**

Fits '99-later Twin Cam-equipped models.

**43943-01** **\$25.95**

Fits '84-'99 Evolution 1340, '87-later XL and '08-'13 XR models.



**F. HEADBOLT COVERS – CHROME**



**F. HEADBOLT COVERS – GLOSS BLACK**



**F. HEADBOLT COVERS – BAR & SHIELD LOGO CHROME**



**F. HEADBOLT COVERS – H-D MOTOR CO. CHROME**



**G. CLASSIC CHROME ROCKER BOX BOLT COVERS**



**Model Family Fitment:**

■ V-ROD

■ SPORTSTER

■ DYNA

■ SOFTAIL

■ TOURING

*Notice: The prices appearing in this catalog are the manufacturer's suggested retail prices. Actual retail prices may vary.*

# 570 ENGINE TRIM

## Hardware Covers

### A. CLASSIC COVERS KIT

Customize your bike down to the last detail. These hardware Cover Kits include the chrome-plated ABS caps and plugs in the sizes and styles required to dress the viewable hardware on the motorcycle. Classic Covers are available as complete Bike Kits with the covers for both engine and chassis hardware, or as engine-only kits to dress the Twin Cam or XL engine. The kits are easy to install, with no tools required.

<b>94947-07</b>	Bike Kit. Fits '99-later Dyna® models.	<b>\$269.95</b>
<b>94923-09</b>	Bike Kit. Fits '09-later Softail® models (except FXCW, FXCWC, FLS and FLSTSB).	<b>\$259.95</b>
<b>94948-07</b>	Bike Kit. Fits '00-'08 Softail models.	<b>\$289.95</b>
<b>94924-09</b>	Bike Kit. Fits '09-later Touring models.	<b>\$259.95</b>
<b>94949-07</b>	Bike Kit. Fits '99-'08 Touring models.	<b>\$259.95</b>
<b>94946-07</b>	Bike Kit. Fits '04-later XL models.	<b>\$194.95</b>
<b>94943-07</b>	Engine Kit. Fits Twin Cam-equipped models.	<b>\$144.95</b>
<b>94944-07</b>	Engine Kit. Fits '04-later XL models.	<b>\$144.95</b>



**A. CLASSIC COVERS KIT**

### Typical Classic Covers Kit Contents

Intended Fastener	Part Number	Bike Kit	Bike Kit	Bike Kit	Bike Kit	Bike Kit	Bike Kit	Engine Kit	Engine Kit
		'04-later XL	'99-later Dyna	'09-later Softail	'00-'08 Softail	'09-later Touring	'99-'08 Touring	'04-later XL	Twin Cam models
		<b>94946-07</b>	<b>94947-07</b>	<b>94923-09</b>	<b>94948-07</b>	<b>94924-09</b>	<b>94949-07</b>	<b>94944-07</b>	<b>94943-07</b>
1/4" socket head cap screw	<b>94903-07</b>	56	56	50	50	55	50	56	50
5/16" socket head cap screw	<b>94904-07</b>	11	11	11	11	8	7	—	7
5/16" socket head cap screw (plug)	<b>94905-07</b>	5	8	4	8	—	—	—	—
3/8" socket head cap screw	<b>94906-07</b>	3	6	6	12	3	3	3	3
5/16" special hex screw (angled cap)	<b>94907-07</b>	—	8	8	8	8	8	—	8
5/16" T40 Torx® button head screw	<b>94908-07</b>	—	5	5	5	10	10	—	—
3/8" T45 Torx button head screw	<b>94909-07</b>	—	5	5	5	—	—	—	—
1/4" 12-point screw	<b>94910-07</b>	—	4	—	4	—	4	—	—
10mm 12-point screw	<b>94911-07</b>	4	8	5	8	4	8	—	—
1/2" flanged hex bolt	<b>94912-07</b>	1	—	1	1	2	—	—	—
3/8" T45 Torx button head screw	<b>94913-07</b>	4	4	10	18	2	—	—	—
7/16" hex bolt	<b>94914-07</b>	5	5	5	5	—	—	—	—
3/8" hex bolt (9/16" hex)	<b>94915-07</b>	1	11	1	11	—	16	—	3
3/8" deep hex bolt (9/16" hex)	<b>94916-07</b>	2	6	—	6	—	—	—	—
1/4" hex bolt (7/16" hex)	<b>94917-07</b>	—	1	—	—	14	14	—	—
5/16" hex bolt (1/2" hex)	<b>94918-07</b>	8	10	4	12	10	16	4	8
1/2" hex bolt	<b>94919-07</b>	2	2	4	4	—	—	—	—
1/2" deep hex bolt	<b>94920-07</b>	—	—	1	1	—	—	—	—
7/16" hex bolt	<b>94941-07</b>	3	—	—	—	—	3	—	—
5/16" T40 Torx button head screw	<b>94942-07</b>	4	6	4	6	—	9	—	—

Notice: The prices appearing in this catalog are the manufacturer's suggested retail prices. Actual retail prices may vary.



# ENGINE TRIM 571

Chrome Hardware Kits



**B. CHROME SOCKET HEAD SCREW COVER KIT**

## B. CHROME SOCKET HEAD SCREW COVER KIT

Finish the show-winning look with these easy-to-install hardware covers. These machined brass and chrome-plated covers are corrosion resistant, and the internal spring steel retention clip resists vibration and thermal cycling to securely hold the covers in place.

<b>94830-02</b>		<b>\$38.95</b>
Fits 1/4" socket head screws with hex drive (pkg. of 10).		
<b>94832-02</b>		<b>\$19.95</b>
Fits 5/16" socket head screws with hex drive (pkg. of 4).		
<b>94834-02</b>		<b>\$19.95</b>
Fits 3/8" socket head screws with hex drive (pkg. of 4).		
<b>94046-03</b>		<b>\$38.95</b>
Fits M6 metric socket head screws with hex drive (pkg. of 10).		



**C. CHROME ALLEN HOLE PLUGS**



**D. CHROME H-D MOTOR CO. LOGO ALLEN HOLE PLUGS**

## C. CHROME ALLEN HOLE PLUGS

<b>94130-93T</b>	1/4"	(pkg. of 10).	<b>\$6.95</b>
<b>94131-93T</b>	5/16"	(pkg. of 10).	<b>\$6.95</b>
<b>94132-93T</b>	3/8"	(pkg. of 10).	<b>\$6.95</b>

## D. CHROME H-D® MOTOR CO. LOGO ALLEN HOLE PLUGS

<b>94527-95</b>	1/4"	(pkg. of 10).	<b>\$9.95</b>
<b>94529-95</b>	5/16"	(pkg. of 10).	<b>\$9.95</b>
<b>94531-95</b>	3/8"	(pkg. of 10).	<b>\$8.95</b>

## E. CHROME HEX BOLT COVERS

Place over a variety of exposed bolts for a cleaner, detailed look. Compression clips for a secure fit. Sold in packages of 6 covers with retaining clips.

<b>43881-96</b>	Fits 1/2" hex bolts.	<b>\$15.95</b>
<b>43850-96</b>	Fits 9/16" hex bolts.	<b>\$15.95</b>

## F. CHROME AIR CLEANER SCREW

Complete the chrome on your stock air cleaner cover with this chrome-plated stainless steel screw, which easily replaces the polished stock air cleaner screw.

<b>29600-00</b>		<b>\$5.95</b>
Fits stock Twin Cam engines (except CVO™ models).		
<b>29703-00</b>	Fits stock Evolution® 1340 engines.	<b>\$4.95</b>

## G. CHROME TIMER COVER SCREW KITS

Dress up accessory timer covers by replacing the stock zinc plate screws with brilliant chrome.

<b>32690-99A</b>	Fits Twin Cam 5-hole timer covers. Kit contains five chrome-plated button head Torx® screws.	<b>\$13.95</b>
<b>94208-04</b>	Fits '04-later XL models.	<b>\$5.95</b>

## H. CHROME DERBY COVER SCREW KIT

Dress up accessory derby covers by replacing the stock zinc-plated screws with brilliant chrome.

<b>25913-99</b>		<b>\$14.95</b>
Fits '99-later Dyna®, Softail®, Touring and Trike models. Kit contains five chrome-plated button head Torx screws and five stainless steel washers.		
<b>94630-98</b>	Fits Evolution 1340 models. Kit includes three button head Torx screws and oil seals.	<b>\$13.95</b>
<b>94631-98</b>	Fits '94-'03 XL models.	<b>\$7.95</b>
<b>94207-04</b>	Fits '04-later XL models.	<b>\$15.95</b>



**E. CHROME HEX BOLT COVERS**



**F. CHROME AIR CLEANER SCREW**



**G. CHROME TIMER COVER SCREW KIT – TWIN CAM SHOWN**



**H. CHROME DERBY COVER SCREW KIT – TWIN CAM SHOWN**

### Model Family Fitment:

V-ROD	SPORTSTER	DYNA
SOFTAIL	TOURING	

Notice: The prices appearing in this catalog are the manufacturer's suggested retail prices. Actual retail prices may vary.

# 572 ENGINE TRIM

## Chrome Hardware Kits

### A. CHROME HARDWARE KIT – PRIMARY COVER

Kit includes the hardware required to replace the visible set of zinc-plated fasteners on the outer primary cover. Inspection and derby cover hardware included. Lock patch included where required.

**94281-04** Fits '04-later XL models. **\$69.95**

**94053-03A** **\$69.95**

Fits '99-'05 Dyna® and '00-'06 Softail® models.

**94052-03A** Fits '99-'06 Touring models. **\$69.95**

**60801-06** **\$69.95**

Fits '06-later Dyna and '07-later Softail models (except FXCW, FXCWC, FXSB, FXSBSE and FXSTSSE3).

**94052-07** **\$69.95**

Fits '07-later Touring and Trike models.

**60607-08** **\$69.95**

Fits '08-later FXCW, FXCWC and FXSTSSE3 models.

### B. CHROME HARDWARE KIT – GEARCASE/FRONT SPROCKET COVER

Kit includes the hardware required to replace the visible set of zinc-plated fasteners on the gearcase and front sprocket cover. Lock patch included where required.

**94280-04** Fits '04-later XL models. **\$49.95**

### C. CHROME HARDWARE KIT – TRANSMISSION

Kit includes the hardware required to replace the visible set of zinc-plated fasteners on the transmission top cover, bearing housing assembly and clutch release cover. Lock patch included where required.

**94056-03** Fits '99-'05 Dyna models. **\$59.95**

**94055-03** Fits '00-'06 Softail models. **\$59.95**

**94054-03** Fits '99-'06 Touring models. **\$59.95**

**34856-06A** **\$59.95**

Fits '06-later Dyna and '07-later Softail and Touring models.

### D. CHROME HARDWARE KIT – ROCKER BOX

Kit includes the hardware required to replace the visible set of zinc-plated fasteners on rocker box covers. Lock patch included where required.

**94291-04A** Fits '04-later XL models. **\$36.95**

**94059-03** **\$36.95**

Fits '99-later Dyna, Touring and Trike models and '00-later Softail models.

### E. CHROME HARDWARE KIT – CAM COVER

Kit includes the hardware required to replace the visible set of zinc-plated fasteners on the cam cover. Cam position sensor cover hardware included. Lock patch included where required.

**94058-03** **\$34.95**

Fits '99-later Dyna, Touring and Trike models and '00-later Softail models.

### F. CHROME HARDWARE KIT – LIFTER/TAPPET BLOCK

Kit includes the hardware required to replace the visible set of zinc-plated fasteners on lifter block covers. Lock patch included where required.

**94068-03** **\$22.95**

Fits '99-later Dyna, Touring and Trike models and '00-later Softail models.



A. CHROME HARDWARE KIT – PRIMARY COVER (TOURING SHOWN)



B. CHROME HARDWARE KIT – GEARCASE/FRONT SPROCKET COVER

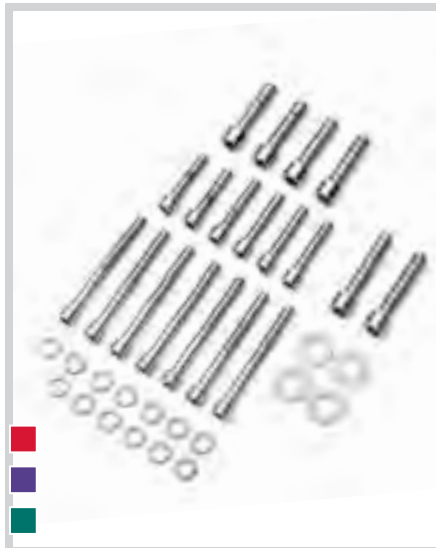

C. CHROME HARDWARE KIT – TRANSMISSION (SOFTAIL SHOWN)



D. CHROME HARDWARE KIT – ROCKER BOX (BIG TWIN SHOWN)

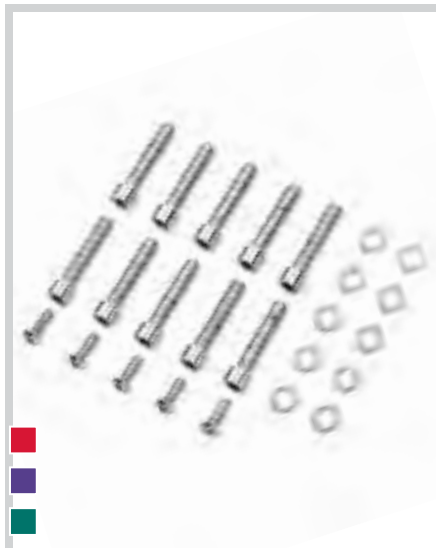

E. CHROME HARDWARE KIT – CAM COVER



F. CHROME HARDWARE KIT – LIFTER/TAPPET BLOCK (BIG TWIN SHOWN)

#### Model Family Fitment:

V-ROD
  SPORTSTER
  DYNA
   
 SOFTAIL
  TOURING

*Notice: The prices appearing in this catalog are the manufacturer's suggested retail prices. Actual retail prices may vary.*



# ENGINE TRIM 573

## Docking Hardware Covers



**G. REAR DOCKING HARDWARE COVER KIT – CHROME**

### G. REAR DOCKING HARDWARE COVER KIT

Disguise the rear docking hardware with these easy-to-install covers. The caps slide over the exposed docking points, and are held in place by a strong magnetic pull. The caps are easy to remove when you wish to reinstall detachable accessories. Covers are available with brilliant chrome or durable gloss black finish to match your bike's attitude. Sold in pairs.

Fits many accessory docking hardware kits. Refer to the fitment matrix below or the Parts & Accessories section of [www.harley-davidson.com](http://www.harley-davidson.com) for details.

<b>48218-10</b>	Short Chrome (pair).	<b>\$34.95</b>
<b>48220-10</b>	Large Chrome (pair).	<b>\$34.95</b>
<b>48035-09</b>	Small Chrome (pair).	<b>\$34.95</b>
<b>48221-10</b>	Short Black (pair).	<b>\$34.95</b>
<b>48223-10</b>	Large Black (pair).	<b>\$34.95</b>
<b>48225-10</b>	Small Black (pair).	<b>\$34.95</b>



**G. REAR DOCKING HARDWARE COVER KIT – BLACK**



Docking Kit Part Number	Fitment	Large		Small		Short	
		Chrome: <b>48220-10</b>	Black: <b>48223-10</b>	Chrome: <b>48035-09</b>	Black: <b>48225-10</b>	Chrome: <b>48218-10</b>	Black: <b>48221-10</b>
<b>XL Models</b>							
<b>53529-04</b>	Fits '04-later XL (some black) models.	—	—	1	—	1	—
<b>53528-95B</b>	Fits '94-'03 XL (without bags) models.	1	—	1	—	—	—
<b>53532-02</b>	Fits '02-'03 XL (with bags) models.	1	—	—	—	—	—
<b>90465-98A</b>	Fits '94-'01 XL (with bags) models.	1	—	—	—	—	—
<b>Dyna® Models</b>							
<b>53961-06</b>	Fits '06-later Dyna® (FXD/L) models.	—	—	1	—	1	—
<b>53964-06B</b>	Fits '08-later FXDF/SE/2 and '06-'08 FXDWG models.	—	—	1	—	1	—
<b>54097-10</b>	Fits '10-later FXDWG (black) models.	—	—	1	—	1	—
<b>53797-09</b>	Fits '09-later FXDB (black) models.	—	—	1	—	1	—
<b>53533-02B</b>	Fits '02-'05 Dyna models.	1	—	—	—	—	—
<b>53882-02B</b>	Fits '02-'05 FXDWG and '01-'02 FXDWG2/3 models.	1	—	—	—	—	—
<b>53858-01</b>	Fits '96-'01 FXDWG (except FXDWG2) models.	1	—	—	—	—	—
<b>53527-95B</b>	Fits '96-'01 Dyna models.	1	—	—	—	—	—
<b>Softail® Models</b>							
<b>53932-03A</b>	Fits '03-later Softail® (without bags) models.	1	—	1	—	—	—
<b>53824-00A</b>	Fits '00-'02 Softail (without bags) models.	1	—	1	—	—	—
<b>53531-95B</b>	Fits '84-'95 Softail models.	1	—	1	—	—	—
<b>Touring Models</b>							
<b>52300131</b>	Fits '14-later Touring (4pt) chrome models.	—	—	2	—	—	—
<b>52300353</b>	Fits '14-later Touring (4pt) chrome models.	—	—	2	—	—	—
<b>52300354</b>	Fits '14-later Touring (4pt) black models.	—	—	2	—	—	—
<b>54205-09</b>	Fits '09-'13 Touring (4pt) chrome models.	—	—	2	—	—	—
<b>54246-09</b>	Fits '09-'13 Touring (4pt) black models.	—	—	2	—	—	—
<b>54030-09</b>	Fits '09-'13 Touring (2pt) chrome models.	—	—	1	—	—	—
<b>54249-09</b>	Fits '09-'13 Touring (2pt) black models.	—	—	1	—	—	—
<b>53803-06</b>	Fits '97-'08 Touring (front) models.	—	—	1	—	—	—
<b>53804-06</b>	Fits '94-'08 Touring (rear) models.	1	—	1	—	—	—
<b>53988-07</b>	Fits '07-'08 FLHRSE3/4 models.	—	—	1	—	1	—

Notice: The prices appearing in this catalog are the manufacturer's suggested retail prices. Actual retail prices may vary.

# 574 ENGINE TRIM

Chrome Hardware

## A. CHROME DOME HEX NUTS

Update the custom look with Chrome Dome hardware. These uniquely styled hex nuts bring a new look to the traditional acorn shape, and feature a low-profile design and a smooth chrome finish.

<b>8067</b>	7/16" – 20 thread (pkg. of 10).	<b>\$1.95</b>
<b>8066</b>	7/16" – 14 thread (pkg. of 10).	<b>\$1.95</b>
<b>8065</b>	3/8" – 24 thread (pkg. of 10).	<b>\$1.95</b>
<b>8064</b>	3/8" – 16 thread (pkg. of 10).	<b>\$1.95</b>
<b>8063</b>	5/16" – 24 thread (pkg. of 10).	<b>\$1.95</b>
<b>8062</b>	5/16" – 18 thread (pkg. of 10).	<b>\$1.95</b>
<b>8061</b>	1/4" – 28 thread (pkg. of 10).	<b>\$1.95</b>
<b>8060</b>	1/4" – 20 thread (pkg. of 10).	<b>\$1.95</b>
<b>8071</b>	10 – 24 thread (pkg. of 10).	<b>\$1.95</b>
<b>8072</b>	10 – 32 thread (pkg. of 10).	<b>\$1.95</b>
<b>8073</b>	1/2" – 13 thread (pkg. of 5).	<b>\$2.95</b>
<b>8074</b>	1/2" – 20 thread (pkg. of 5).	<b>\$2.95</b>



A. CHROME DOME HEX NUTS



A. CHROME DOME HEX NUTS

## B. WINDSHIELD ACORN NUT KIT

Kit contains 10 chrome-plated low crown 12-24 acorn nuts.

**94111-95** **\$9.95**

Fits Compact, King-Size, Convertible and Road King® windshields (pkg. of 10).



B. WINDSHIELD ACORN NUT KIT



C. CHROME ACORN NUT KITS

## C. CHROME ACORN NUT KITS

<b>94115-93T</b>	10 – 24 thread (pkg. of 5).	<b>\$5.95</b>
<b>94116-93T</b>	10 – 32 thread (pkg. of 5).	<b>\$5.95</b>
<b>94117-93T</b>	1/4" – 20 thread (pkg. of 5).	<b>\$5.95</b>
<b>94118-93T</b>	1/4" – 28 thread (pkg. of 5).	<b>\$5.95</b>
<b>94119-93T</b>	5/16" – 18 thread (pkg. of 4).	<b>\$5.95</b>
<b>94120-93T</b>	5/16" – 24 thread (pkg. of 4).	<b>\$5.95</b>
<b>94121-93T</b>	3/8" – 16 thread (pkg. of 3).	<b>\$5.95</b>
<b>94122-93T</b>	3/8" – 24 thread (pkg. of 3).	<b>\$5.95</b>
<b>94123-93T</b>	7/16" – 14 thread (pkg. of 2).	<b>\$5.95</b>
<b>94124-93T</b>	7/16" – 20 thread (pkg. of 2).	<b>\$5.95</b>
<b>94125-93T</b>	1/2" – 13 thread (pkg. of 1).	<b>\$5.95</b>
<b>94126-93T</b>	1/2" – 20 thread (pkg. of 1).	<b>\$5.95</b>
<b>94127-93T</b>	5/8" – 18 thread (pkg. of 1).	<b>\$5.95</b>

## D. CHROME TORX® BUTTON HEAD SCREWS

Available in 1/4-inch, 5/16-inch and 3/8-inch coarse thread, up to 2-1/4 inches long. Grade 8. See your Dealer for more information.

## E. CHROME HEX SOCKET BUTTON HEAD SCREWS

Available in 8-32, 10-24, 10-32, 1/4-inch, 5/16-inch and 3/8-inch, up to 1 inch long. See your Dealer for more information.

## F. CHROME TORX SOCKET HEAD SCREWS

Available in 1/4-inch, 5/16-inch and 3/8-inch coarse thread, up to 2-1/4 inches long. Grade 8. See your Dealer for more information.

## G. CHROME SOCKET HEAD SCREWS

Available in 1/4-inch, 5/16-inch and 3/8-inch coarse and fine thread, up to 3 inches long. See your Dealer for more information.



D. CHROME TORX BUTTON HEAD SCREWS



E. CHROME HEX SOCKET BUTTON HEAD SCREWS



F. CHROME TORX SOCKET HEAD SCREWS



G. CHROME SOCKET HEAD SCREWS

*Notice: The prices appearing in this catalog are the manufacturer's suggested retail prices. Actual retail prices may vary.*



# ENGINE TRIM 575

Chrome Hardware



**H. CHROME SMOOTH SOCKET HEAD SCREWS**



**I. CHROME HEX HEAD SCREWS**

**H. CHROME SMOOTH SOCKET HEAD SCREWS**

Available in 1/4-inch, 5/16-inch and 3/8-inch coarse and fine thread, up to 3 inches long. See your Dealer for more information.

**I. CHROME HEX HEAD SCREWS**

Available in 1/4-inch, 5/16-inch and 3/8-inch coarse and fine thread, up to 3 inches long. See your Dealer for more information.

**J. CHROME 12-POINT SCREWS**

Available in 1/4-inch, 5/16-inch and 3/8-inch coarse thread, up to 2-1/4 inches long. Grade 8. See your Dealer for more information.

**K. CHROME FLAT-HEAD SCREWS**

When the details matter, even your screws are chromed. These Grade 8 Hex Drive screws are available in 17 different sizes. See your Dealer for more information.

**L. CHROME LOCK NUTS WITH NYLON INSERTS**

Available in 10-24, 1/4-inch, 5/16-inch, 3/8-inch, 7/16-inch and 5/8-inch sizes, coarse and fine thread. See your Dealer for more information.

**M. CHROME HEX NUTS**

Available in 1/4-inch, 5/16-inch and 3/8-inch sizes, coarse and fine thread. See your Dealer for more information.

**N. CHROME FLAT WASHERS**

Available in 1/4-inch, 5/16-inch and 3/8-inch sizes. See your Dealer for more information.

**O. CHROME LOCK WASHERS**

Available in 1/4-inch, 5/16-inch and 3/8-inch sizes. See your Dealer for more information.



**J. CHROME 12-POINT SCREWS**



**K. CHROME FLAT-HEAD SCREWS**



**L. CHROME LOCK NUTS WITH NYLON INSERTS**



**M. CHROME HEX NUTS**



**N. CHROME FLAT WASHERS**



**O. CHROME LOCK WASHERS**

**Model Family Fitment:**

- V-ROD
- SPORTSTER
- DYNA
- SOFTAIL
- TOURING

*Notice: The prices appearing in this catalog are the manufacturer's suggested retail prices. Actual retail prices may vary.*



GENUINE MOTOR PARTS & ACCESSORIES



2015

## CONTROLS

Get a grip on style with custom controls from hand to foot. A new handlebar can make all the difference in rider comfort, while grips, hand controls, footpegs, and mirrors can provide the extra styling touches you're looking for.





---

## AT ARM'S REACH

From a rider's perspective, the hand controls are one of the most visual parts of the bike. They are the first thing you touch when you drop into the saddle, and what you see every mile you ride. That makes your controls a prime candidate for special treatment. Designed to put an integrated look just a few wrench turns away, installing one of our hand and foot control collections is a solid first step to an all-out custom journey.

# CONTROLS 579

## Hand Grips



A. GET-A-GRIP HAND GRIPS – CHROME



A. GET-A-GRIP HAND GRIPS – BLACK



B. NOSTALGIC HAND GRIPS – WHITE



C. NOSTALGIC HAND GRIPS – BLACK

### A. GET-A-GRIP™ HAND GRIPS

Dressed in tactified rubber for superior traction, these elegant hand grips provide a positive connection to the controls in wet or dry weather. The soft touch cross-hatched rubber surface feels good against both gloved and bare skin and the "thicker in the middle" profile forms a natural fit with your closed fist. Shaped for maximum comfort, Get-A-Grip™ hand grips are available in your choice of standard or magnum diameters to comfortably accommodate almost any size hand. And you don't need to sacrifice style for comfort. Designed to accent any customizing direction, the mirror-chrome or gloss black finishes complement both traditional and contemporary looks. The easy-to-install "glueless" design allows you to remove the grips for service without damage.

Fits '96-later VRSC™, XL, XR, Dyna®, Softail® (except FLSTSE2/3, FLSTNSE and FXSBSE) and '96-'07 Touring models.

<b>56100007</b>	Chrome, Standard 1.5" Diameter.	<b>\$79.95</b>
<b>56100009</b>	Chrome, Magnum 1.6" Diameter.	<b>\$79.95</b>
<b>56100008</b>	Black, Standard 1.5" Diameter.	<b>\$79.95</b>
<b>56100010</b>	Black, Magnum 1.6" Diameter.	<b>\$79.95</b>

Fits '08-later Touring, Trike, FLSTSE2/3, FXSBSE and FLSTNSE models.

<b>56100015</b>	Chrome, Magnum 1.6" Diameter.	<b>\$84.95</b>
<b>56100036</b>	Black, Magnum 1.6" Diameter.	<b>\$84.95</b>

### B. NOSTALGIC HAND GRIPS – WHITE

Comfortable nostalgic hourglass style with a chrome accent ring and a molded-in "Harley-Davidson" logo. These rubber grips were inspired by Harley-Davidson® motorcycles of the 1940s. White hand grips complement the style of a classic ride and lend a touch of tradition to the hot "bobber" look.

<b>56100054</b>		<b>\$69.95</b>
Fits '96-later VRSC, XL, XR, Dyna, Softail (except FLSTSE2/3, FLSTNSE and FXSBSE) and '96-'07 Touring models.		

### C. NOSTALGIC HAND GRIPS – BLACK

Comfortable nostalgic hourglass style with a chrome accent ring and a molded-in "Harley-Davidson" logo. These rubber grips were inspired by Harley-Davidson motorcycles of the 1940s.

<b>56275-96B</b>		<b>\$64.95</b>
Fits '96-later VRSC, XL, XR, Dyna, Softail (except FLSTSE2/3, FLSTNSE and FXSBSE) and '96-'07 Touring models.		
<b>56275-08</b>		<b>\$69.95</b>
Fits '08-later Touring, Trike, FLSTSE2/3, FXSBSE and FLSTNSE models.		

#### Model Family Fitment:

 V-ROD	 SPORTSTER	 DYNA
 SOFTAIL	 TOURING	

Notice: The prices appearing in this catalog are the manufacturer's suggested retail prices. Actual retail prices may vary.



# 580 CONTROLS

## Hand Grips – Heated

### HEATED HAND GRIPS

Keep comfortable on those cool mornings or frigid night rides. Warm hands have a major impact on overall body comfort and sometimes gloves just aren't enough. These thermostatically controlled grips feature variable heat settings controlled with a military grade resistor and use automatic temperature monitoring to adjust to ambient temperatures. With both hands on the grips, they will remain at a constant temperature regardless of changes in outside temperature. The self-contained control circuit and control knob means you have no additional switches or controller boxes to mount and the grips are switched on/off with the ignition to avoid draining your battery. The "glueless" grip design allows grip removal if you change handlebars or motorcycles.

#### A. HEATED HAND GRIPS – SLIPSTREAM

Slipstream Grips have been thermally mapped to provide a more uniform heat and are designed to achieve a maximum operating temperature approximately 20° Fahrenheit warmer than previous accessory heated grips for added warmth during cold rides.

**56100027** **\$269.95**

Fits '08-later Touring and Trike models (except CVO™). '14-later Touring and Trike models require separate purchase of Electrical Connection Kit P/N 69200722. Not for use with internally wired handlebars.

**56100030** **\$259.95**

Fits '96-later VRSC™, XL, XR, Dyna®, Softail® (except FLSTNSE, FLSTSE2/3, FXDB and FXSBSE) and '96-'07 Touring models. '14-later XL, '12-later Dyna and '11-later Softail models require separate purchase of Electrical Connection Kit P/N 72673-11. Not for use with internally wired handlebars.

#### B. HEATED HAND GRIPS – STREAMLINER

Complement the Streamliner look with these matching grips. The rich black rubber provides a positive grip while riding and the chrome tri-line design will provide just the right touch of chrome. These grips have been thermally mapped to provide a more uniform heat and are designed to achieve a maximum operating temperature approximately 20° Fahrenheit warmer than previous accessory heated grips for added warmth during cold rides.

**56100047** **\$269.95**

Fits '08-later Touring and Trike models (except CVO). '14-later Touring and Trike models require separate purchase of Electrical Connection Kit P/N 69200722. Not for use with internally wired handlebars.

#### C. HEATED HAND GRIPS – BLACK RUBBER

Original Equipment on the FLHTK Ultra Limited model, these Black Rubber Heated Grips feature smooth surfaces and a clean design that complements any styling direction.

**56100034** **\$199.95**

Fits '08-later Touring and Trike models (except CVO). '08-'09 models require separate purchase of jumper harness P/N 70415-08A, connector P/N 72902-01BK and terminal pin P/N 72990-01 (qty 2). See instruction sheet for details. Not for use with internally wired handlebars.



A. HEATED HAND GRIPS – SLIPSTREAM



B. HEATED HAND GRIPS – STREAMLINER



C. HEATED HAND GRIPS – BLACK RUBBER

#### Model Family Fitment:

■ V-ROD   ■ SPORTSTER   ■ DYNA  
■ SOFTAIL   ■ TOURING

*Notice: The prices appearing in this catalog are the manufacturer's suggested retail prices. Actual retail prices may vary.*

# CONTROLS 581

Hand Grips – Heated



**D. CONTOURED HEATED HAND GRIPS**

## D. HEATED HAND GRIPS

Keep comfortable on those cool morning or frigid night rides. Warm hands have a major impact on overall body comfort and sometimes gloves just aren't enough. These thermostatically controlled grips have variable heat settings and automatic temperature monitoring to adjust to changing ambient temperatures. With both hands in place, the grips remain at a constant temperature regardless of changes in outside temperatures. The self-contained control circuit and control knob means you have no additional switches or controller boxes to mount and the grips are switched on/off with the ignition to avoid draining your battery. The "glueless" grip design allows grip removal if you change handlebars or motorcycles.

Fits '96-later VRSC™, XL, XR, Dyna®, Softail® (except FLSTNSE, FLSTSE2/3, FXDB and FXSBSE) and '96-'07 Touring models. '14-later XL, '12-later Dyna and '11-later Softail models require separate purchase of Electrical Connection Kit P/N 72673-11. Not for use with internally wired handlebars.

<b>56512-02C</b>	Contoured.	<b>\$259.95</b>
<b>56047-03C</b>	Flame.	<b>\$259.95</b>
<b>56926-05A</b>	Willie G Skull.	<b>\$259.95</b>
<b>56196-03C</b>	Chrome and Rubber – Small.	<b>\$259.95</b>
<b>56174-03C</b>	Chrome and Rubber – Large.	<b>\$259.95</b>
<b>56619-03B</b>	Nostalgic.	<b>\$259.95</b>
<b>56750-04B</b>	Stealth.	<b>\$259.95</b>

Fits '08-later Touring and Trike models (except CVO™). '14-later Touring models require separate purchase of Electrical Connection Kit P/N 69200722. Not for use with internally wired handlebars.

<b>56512-08A</b>	Contoured.	<b>\$269.95</b>
<b>56047-08A</b>	Flame.	<b>\$269.95</b>
<b>56926-08A</b>	Willie G Skull.	<b>\$269.95</b>
<b>56196-08A</b>	Chrome and Rubber – Small.	<b>\$269.95</b>



**D. CONTOURED HEATED HAND GRIPS**



**D. FLAME HEATED HAND GRIPS**



**D. WILLIE G SKULL HEATED HAND GRIPS**



**D. CHROME AND RUBBER HEATED HAND GRIPS**



**D. NOSTALGIC HEATED HAND GRIPS**



**D. STEALTH HEATED HAND GRIPS**

### Model Family Fitment:

- V-ROD
- SPORTSTER
- DYNA
- SOFTAIL
- TOURING

*Notice: The prices appearing in this catalog are the manufacturer's suggested retail prices. Actual retail prices may vary.*



# 582 CONTROLS

Hand Grip & Foot Control Collections

## EDGE CUT COLLECTION

Live your life on the edge. The Edge Cut Collection features a crisp anodized finish that is machined to expose the highlights of raw aluminum. The contrasting cut back look makes a powerful visual statement and works great with both traditional and contemporary customizing styles.

### A. EDGE CUT HAND GRIPS

The hand grips are a comfortable 1.5" diameter and the machined slots and narrow rubber bands offer plenty of traction, with or without gloves. Glueless design permits removal for servicing without damage.

**57454-10** **\$94.95**  
Fits '96-later VRSC™, XL, XR, Dyna®, Softail® (except FLSTSE2/3, FLSTNSE and FXSBSE) and '96-'07 Touring models.

**57457-10** **\$99.95**  
Fits '08-later Touring, Trike, FLSTSE2/3, FXSBSE and FLSTNSE models.



A. EDGE CUT HAND GRIPS

### B. EDGE CUT FOOTPEGS

The slim footpeg design allows a comfortable pivot point and the wide surface and narrow rubber bands hold your boots firmly in place.

**49312-10** Footpegs. **\$84.95**  
Fits models with H-D® male mount-style footpeg supports (except the rider position on '08-later FXCW, FXCWC, FXS, FXSB, FXSBSE, '07-later XL883N, XL1200N, XL1200T, XL1200V, XL1200X, '07-'10 XL883L, '11-later XL1200C and '08-'13 XR models).

**50500030** Footpegs with Styled Wear Peg. **\$94.95**  
Fits '12-later XL1200V, '11-later XL883L and XL1200C, '10-later XL1200X, '08-'11 FXCW, FXCWC and '11-later FXS and FXSB models.

Shown with:

#### EDGE CUT SHIFTER PEG

Shifter pegs feature a slim design for easy access and narrow rubber bands that protect your boot toe from abrasion during shifting.

**34671-10** **\$29.95**  
Fits all models (except '06-later VRSC models with forward controls and '08-'13 XR models).



B. EDGE CUT FOOTPEGS AND SHIFTER PEG

### C. EDGE CUT BRAKE PEDAL PADS

Available in two sizes, the brake pedal pads feature deep surface grooves and narrow rubber bands for traction during application.

**41449-10** Large. **\$49.95**  
Fits '12-later Dyna FLD, '86-later FL Softail and '80-later Touring and Trike models.

**42847-10** Small. **\$44.95**  
Fits '15-later XG, '84-later FX Softail (except FXSTDSE) and '93-later Dyna models equipped with forward controls.



C. EDGE CUT BRAKE PEDAL PADS

### D. EDGE CUT FOOTBOARD INSERT KITS

Machined from billet aluminum, these footboard inserts retain the cast-in vibration isolation found on Original Equipment footboards. The over-molded rubber provides both comfort and traction while riding. Kit includes right and left insert.

**54187-10** Rider – Traditional Shape. **\$199.95**  
Fits models with traditional-shaped rider footboards.

**54196-10** Passenger – Traditional Shape. **\$179.95**  
Fits models equipped with traditional-shaped passenger footboards.



D. EDGE CUT RIDER FOOTBOARD INSERTS – TRADITIONAL SHAPE (SHOWN WITH LARGE EDGE CUT BRAKE PEDAL PAD)



D. EDGE CUT PASSENGER FOOTBOARD INSERTS – TRADITIONAL SHAPE

Model Family Fitment:

- V-ROD
- SPORTSTER
- DYNA
- SOFTAIL
- TOURING

*Notice: The prices appearing in this catalog are the manufacturer's suggested retail prices. Actual retail prices may vary.*

# CONTROLS 583

Hand Grip & Foot Control Collections

CONTROLS



NEW

E. BURST HAND GRIPS

## THE BURST COLLECTION – CONTROLS

Split with tradition. The Burst Collection takes your ride in a new hard-edged direction. A rich mixture of tuxedo black, satin aluminum and chrome finishes, each component in this complete collection features a black-filled Bar & Shield logo to tie the look together. The resulting combination of contrasting edges makes a powerful visual statement that complements both classic and contemporary customizing styles. The Burst Collection components create an impact all by themselves, but can also be seamlessly combined with edge cut and other gloss black accessories to complete the look.

### E. BURST HAND GRIPS

The easy-to-install hand grips are a comfortable 1.6" diameter and feature a "glueless" design that can be removed for service without damage.

**56100101** **\$129.95**  
Fits '96-later VRSC™, XL, XR, Dyna® and Softail® (except FLSTSE2/3, FLSTNSE and FXSBSE) and '96-'07 Touring models.

**56100098** **\$139.95**  
Fits '08-later Touring, Trike, FLSTSE2/3, FXSBSE and FLSTNSE models.

### F. BURST FOOTPEGS

Round footpeg design allows a comfortable pivot point and the wide surface and large diameter end cap keep your foot in place. Rectangular footpeg rotation is adjustable for position, so your feet ride on the rubber treads whether used as a rider, passenger or highway peg.

**33600059** Footpegs – Round. **\$109.95**  
Fits models with H-D® male mount-style footpeg supports (except the rider position on '08-later FXCW, FXCWC, FXS, FXSB, FXSBSE, '07-later XL883N, XL1200N, XL1200V, XL1200X, '07-'10 XL883L, '11-later XL1200C, XL1200T and '08-'13 XR models).

**50500367** Footpegs – Rectangular. **\$159.95**  
Fits models with H-D male mount-style footpeg supports (except the rider position on '15-later XG, '08-later FXCW, FXCWC, FXS, FXSB, FXSBSE, '07-later XL883N, XL1200N, XL1200V, XL1200X, '07-'10 XL883L, '11-later XL1200C, XL1200T and '08-'13 XR models).

**50500441** Footpegs with Styled Wear Peg. **\$129.95**  
Fits '12-later XL1200V, '11-later XL883L and XL1200C, '10-later XL1200X, '08-'11 FXCX, FXCWC and '11-later FXS and FXSB models.

### Shown with:

#### BURST SHIFTER PEG

These black anodized, machined shifter pegs add a unique, custom style. Easy to install and features rubber backing to protect the toe of your boot from scuffing.

**33600032** **\$29.95**  
Fits all models (except '06-later VRSC models with forward controls and '08-'13 XR models).

### G. BURST BRAKE PEDAL PAD

Styled to complement the distinctive black and satin aluminum look of the Burst Collection, this easy-to-install brake pedal pad completes the clean, custom billet look.

**50600104** Large. **\$59.95**  
Fits '12-later Dyna FLD, '86-later FL Softail and '80-later Touring and Trike models.

**50600140** Small. **\$49.95**  
Fits '15-later XG, '84-later FX Softail (except FXSTDSE) and '93-later Dyna models equipped with forward controls.

### H. BURST FOOTBOARD KITS

Long and lean, these half-shield shaped footboards add a unique, custom style to your ride. The kit includes black anodized footboard pans and vibration-isolated Burst Collection inserts. The high-traction black rubber cross-hatch inserts feature an embossed Bar & Shield logo and are set into a machined black and aluminum surround. Footboards are easy to install.

**50500244** Rider. **\$399.95**  
Fits '12-later Dyna FLD and '86-later FL Softail (except FLS and FLSTFB) and Touring and Trike models (except FLHTKL and FLHTCUL).

**50500245** Passenger. **\$289.95**  
Fits '06-later Dyna, '00-later Softail and '86-later Touring models equipped with passenger footboard supports. Does not fit Trike models.



NEW

F. BURST FOOTPEGS AND SHIFTER PEG



NEW

G. BURST BRAKE PEDAL PADS



H. BURST RIDER FOOTBOARD



H. BURST PASSENGER FOOTBOARD

Notice: The prices appearing in this catalog are the manufacturer's suggested retail prices. Actual retail prices may vary.



# 584 CONTROLS

## Hand Grip & Foot Control Collections

### SLIPSTREAM COLLECTION

Go with the flow. The rich mirror-finish chrome surfaces and contrasting thick black pads set the tone for the complete Slipstream Collection. The design features stylish aero-inspired spears deeply embedded in the surface and square-shouldered rubber pads for contemporary looks and added traction.

#### A. SLIPSTREAM HAND GRIPS

Easy-to-install hand grips are a comfortable 1.5" diameter and feature a "glueless" design that can be removed for service without damage.

**56100029** **\$94.95**  
Fits '96-later VRSC™, XL, XR, Dyna®, Softail® (except FLSTSE2/3, FLSTNSE and FXSBSE) and '96-'07 Touring models.

**56100028** **\$99.95**  
Fits '08-later Touring, Trike, FLSTSE2/3, FXSBSE and FLSTNSE models.



A. SLIPSTREAM HAND GRIPS

#### B. SLIPSTREAM FOOTPEGS

These easy-to-install footpegs feature a styled back surface so the pegs look great in the extended or folded position.

**50500091** **\$99.95**  
Fits models with H-D® male mount-style footpeg supports (except the rider position on '15-later XG, '08-later FXCW, FXCWC, FXS, FXSB, FXSBSE, '07-later XL883N, XL1200N, XL1200T, XL1200V, XL1200X, '07-'10 XL883L, '11-later XL1200C and '08-'13 XR models).

**50500262** **\$109.95**  
Footpegs with Wear Peg.  
Fits '12-later XL1200V, '11-later XL883L and XL1200C, '10-later XL1200X, '08-'11 FXCW, FXCWC and '11-later FXS and FXSB models.

#### Shown with:

#### SLIPSTREAM SHIFTER PEG

This easy-to-install Shifter Peg is adjustable for proper angle and comfort and features a rubber backing to protect the toe of your boot from scuffing during shifting.

**33600008** **\$29.95**  
Fits all models (except '06-later VRSC models with forward controls and '08-'13 XR models).



B. SLIPSTREAM FOOTPEGS AND SHIFTER PEG



C. SLIPSTREAM BRAKE PEDAL PADS

#### C. SLIPSTREAM BRAKE PEDAL PADS

Available in two sizes, these easy-to-install brake pedal pads complete the stylish look of the Slipstream Collection.

**50600037** **\$44.95**  
Small.  
Fits '84-later FX Softail models (except FXSTDSE) and '93-later Dyna models equipped with forward controls.

**50600040** **\$59.95**  
Large.  
Fits '12-later Dyna FLD, '86-later FL Softail and '80-later Touring and Trike models.

#### D. SLIPSTREAM FOOTBOARD INSERT KITS

These footboard inserts retain the cast-in vibration isolation found on Original Equipment footboards and the thick rubber pads provide traction and protect the brilliant chrome surround. Kit includes right and left insert.

**50500093** **\$149.95**  
Rider – Traditional Shape.  
Fits '12-later Dyna FLD and '86-later Softail, Touring and Trike models equipped with traditional-shaped rider footboards.

**50500096** **\$119.95**  
Passenger – Traditional Shape.  
Fits models equipped with traditional-shaped passenger footboards.

**50500089** **\$149.95**  
Rider – Swept Wing Shape.  
Fits '12-later Dyna FLD and '86-later Softail, Touring and Trike models equipped with Swept Wing-shaped rider footboards.

**50500090** **\$119.95**  
Passenger – Swept Wing Shape.  
Fits '06-later Dyna, '00-later Softail (except FLS) and '86-later Touring models equipped with Swept Wing-shaped passenger footboards. Does not fit Trike models. If installed on models equipped with Passenger Footboard Support kit P/N 50399-07A, footboards will not remain in flipped up position.



D. SLIPSTREAM RIDER FOOTBOARD INSERTS – TRADITIONAL (SHOWN WITH LARGE SLIPSTREAM BRAKE PEDAL PAD)



D. SLIPSTREAM PASSENGER FOOTBOARD INSERTS – TRADITIONAL



D. SLIPSTREAM RIDER FOOTBOARD INSERTS – SWEEP WING (SHOWN WITH LARGE SLIPSTREAM BRAKE PEDAL PAD)



D. SLIPSTREAM PASSENGER FOOTBOARD INSERTS – SWEEP WING

*Notice: The prices appearing in this catalog are the manufacturer's suggested retail prices. Actual retail prices may vary.*

# CONTROLS 585

Hand Grip & Foot Control Collections



E. TRIBAL HAND GRIPS



## TRIBAL COLLECTION

Tribal art adds an element of ancient mystery, with a monochrome palette and simple lines that transform into a totem meant to be worn proudly. The design features smooth black rubber surfaces that rise above the cast-in recesses of the jet black shell, adding depth and dimension to the collection.

### E. TRIBAL HAND GRIPS

The easy-to-install hand grips are a comfortable 1.5" diameter and feature a "glueless" design that can be removed for service without damage.

**56254-09** **\$94.95**

Fits '96-later VRSC™, XL, XR, Dyna®, Softail® (except FLSTSE2/3, FLSTNSE and FXSBSE) and '96-'07 Touring models.

**56257-09** **\$99.95**

Fits '08-later Touring, Trike, FLSTSE2/3, FXSBSE and FLSTNSE models.



F. TRIBAL FOOTPEGS AND SHIFTER PEG



G. TRIBAL BRAKE PEDAL PADS



### F. TRIBAL FOOTPEGS

Footpeg rotation is adjustable for position, so your feet ride on the rubber pad whether used as a rider, passenger or highway peg. Kit includes left and right peg.

**51376-09** **\$84.95**

Fits models with H-D® male mount-style footpeg supports (except the rider position on '15-later XG, '08-later FXCW, FXCWC, FXS, FXSB, FXSBSE, '07-later XL883N, XL1200N, XL1200T, XL1200V, XL1200X, '07-'10 XL883L, '11-later XL1200C and '08-'13 XR models).

Shown with:

#### TRIBAL SHIFTER PEG

The easy-to-install Shifter Peg is adjustable for comfort and the rubber backing protects the toe of your boot from scuffing during shifting.

**34669-09A** **\$29.95**

Fits all models (except '06-later VRSC models with forward controls and '08-'13 XR models).

### G. TRIBAL BRAKE PEDAL PADS

This easy-to-install Brake Pedal Pad complements the Tribal Collection for a complete custom look.

**42500-09** Large **\$49.95**

Fits '12-later Dyna FLD, '86-later FL Softail and '80-later Touring and Trike models.

**42008-09** Small **\$44.95**

Fits '84-later FX Softail (except FXSTDSE) and '93-later Dyna models equipped with forward controls.

### H. TRIBAL FOOTBOARD INSERT KITS

Easy-to-install footboard kits retain the Original Equipment cast-in vibration isolation for a fatigue-free ride. Kit includes left and right insert.

**50269-09** Rider – Half-Moon Shape **\$99.95**

Fits '86-later Softail models equipped with Half Moon-shaped rider footboards.

**50535-09** Passenger – Half-Moon Shape **\$89.95**

Fits '06-later Dyna, '00-later Softail and '86-later Touring models equipped with Half Moon-shaped passenger footboards. Does not fit Trike models.

**50753-10** Rider – Swept Wing Shape **\$99.95**

Fits '12-later Dyna FLD and '86-later Softail, Touring and Trike models equipped with Swept Wing-shaped rider footboards.

**50760-10** Passenger – Swept Wing Shape **\$89.95**

Fits '06-later Dyna, '00-later Softail and '86-later Touring models equipped with Swept Wing-shaped passenger footboards. Does not fit Trike models.



H. TRIBAL RIDER FOOTBOARD INSERTS – HALF MOON (SHOWN WITH LARGE TRIBAL BRAKE PEDAL PAD)



H. TRIBAL PASSENGER FOOTBOARD INSERTS – HALF MOON



H. TRIBAL RIDER FOOTBOARD INSERTS – SWEEP WING (SHOWN WITH LARGE TRIBAL BRAKE PEDAL PAD)



H. TRIBAL PASSENGER FOOTBOARD INSERTS – SWEEP WING



Model Family Fitment:



Notice: The prices appearing in this catalog are the manufacturer's suggested retail prices. Actual retail prices may vary.



# 586 CONTROLS

## Hand Grip & Foot Control Collections

### STEALTH COLLECTION

Just like a Stealth fighter, you may not hear it coming, but you'll definitely know when it arrives. The mirror-chrome finish, deep tapered grooves and thin black rubber tread make the Stealth Collection anything but invisible.

#### A. STEALTH HAND GRIPS

These hand grips feature a smooth contoured shape, "ball-milled" grooves, raised rubber tread and a "glueless" design that allows removal without damage.

**56729-04** **\$94.95**

Fits '96-later VRSC™, XL, XR, Dyna®, Softail® (except FLSTSE2/3, FLSTNSE and FXSBSE) and '96-'07 Touring models.

**56729-08** **\$99.95**

Fits '08-later Touring, Trike, FLSTSE2/3, FXSBSE and FLSTNSE models.

#### B. STEALTH FOOTPEGS

Footpeg rotation is adjustable for position, so your feet ride on the rubber treads whether used as a rider, passenger or highway peg. Kit includes left and right peg.

**50359-04** **\$84.95**

Fits models with H-D® male mount-style footpeg supports (except the rider position on '15-later XG, '08-later FXCW, FXCWC, FXS, FXSB, FXSBSE, '07-later XL883N, XL1200N, XL1200T, XL1200V, XL1200X, '07-'10 XL883L, '11-later XL1200C and '08-'13 XR models).

**Shown with:**

#### STEALTH SHIFTER PEG

This easy-to-install shifter peg can be rotated to a comfortable position and the smooth back protects the toe of your boot from wear while shifting.

**34664-04** **\$29.95**

Fits all models (except '06-later VRSC models with forward controls and '08-'13 XR models).

#### C. STEALTH BRAKE PEDAL PADS

Available in two sizes to fit most Harley-Davidson® motorcycles, these easy-to-install brake pedal pads complement the Stealth Collection pegs and footboard inserts for a complete look.

**42555-04** Large. **\$69.95**

Fits '12-later Dyna FLD, '86-later FL Softail and '80-later Touring and Trike models.

**42650-08** Small. **\$44.95**

Fits '84-later FX Softail models (except FXSTDSE) and '93-later Dyna models equipped with forward controls.

#### D. STEALTH FOOTBOARD INSERTS

The Footboard Insert Kit features "ball-milled" Harley-Davidson script logo, tapered grooves, raised rubber tread and the distinct Swept Wing footboard shape.

**50202-04** Rider – Swept Wing. **\$239.95**

Fits '12-later Dyna FLD and '86-later Softail, Touring and Trike models equipped with Swept Wing-shaped rider footboards.

**50358-04** Passenger – Swept Wing. **\$199.95**

Fits models equipped with Swept Wing Passenger Footboards. Does not fit Softail or Trike models. Models equipped with accessory derby covers requires separate purchase of Passenger Footboard Support Kit P/N 52714-04.



A. STEALTH HAND GRIPS



B. STEALTH FOOTPEGS AND SHIFTER PEG



C. STEALTH BRAKE PEDAL PADS



D. STEALTH RIDER FOOTBOARD INSERTS – SWEEP WING (SHOWN WITH LARGE STEALTH BRAKE PEDAL PAD)



D. STEALTH PASSENGER FOOTBOARD INSERTS – SWEEP WING

*Notice: The prices appearing in this catalog are the manufacturer's suggested retail prices. Actual retail prices may vary.*

# CONTROLS 587

Hand Grip & Foot Control Collections



**E. SILENCER HAND GRIPS**

## THE SILENCER COLLECTION

Make your own noise. Unique electroless nickel plating provides this collection with a warm, burnished finish that looks like you've been twisting this throttle for years. The warm look of the nickel will complement both bright and satin paint colors and looks right when paired with the black Original Equipment hand controls. The precision drilled surfaces bite against the palm of your glove and boot sole for positive grip and provide the gun barrel look.

### E. SILENCER HAND GRIPS

Hand grips are a comfortable 1.4" diameter for a compact custom look and the "glueless" design allows easy removal for service without damage.



**55869-10** **\$84.95**  
Fits '96-later VRSC™, XL, XR, Dyna®, Softail® (except FLSTSE2/3, FLSTNSE and FXSBSE) and '96-'07 Touring models.

### F. SILENCER FOOTPEGS AND SHIFTER PEG

These small-diameter footpegs offer the ideal pivot point to operate the brake and shift levers and the wide surface provides room to rest your boot.

**1. 50056-10** Footpegs. **\$84.95**  
Fits models with H-D® male mount-style footpeg supports (except the rider position on '08-later FXCW, FXCWC, FXS, FXSB, FXSBSE, '07-later XL883N, XL1200N, XL1200T, XL1200V, XL1200X, '07-'10 XL883L, '11-later XL1200C and '08-'13 XR models).

**2. 50039-10** Footpegs with Wear Peg. **\$89.95**  
Fits '07-'10 XL883L, '07-later XL883N, XL1200N, XL1200T and '08-'13 XR models.

**3. 50500025** Footpegs with Styled Wear Peg. **\$94.95**  
Fits '12-later XL1200V, '11-later XL883L and XL1200C, '10-later XL1200X, '08-'11 FXCW and FXCWC and '11-later FXS and FXSB models.

**4. 35286-10** Shifter Peg. **\$24.95**  
Fits all models (except '06-later VRSC models with forward controls and '08-'13 XR models).

### G. SILENCER BRAKE PEDAL PAD

The easy-to-install compact brake pedal pad completes the custom Silencer look. Includes mounting hardware.

**48990-10** Small. **\$44.95**  
Fits '15-later XG, '84-later FX Softail models (except FXSTDSE) and '93-later Dyna models equipped with Forward Controls.



**E. SILENCER HAND GRIPS**



**F. SILENCER FOOTPEGS AND SHIFTER PEG**



**G. SILENCER BRAKE PEDAL PADS**



**G. SILENCER BRAKE PEDAL PAD (SHOWN WITH SILENCER FOOTPEG WITH STYLED WEAR PEG)**

#### Model Family Fitment:

- V-ROD
- SPORTSTER
- DYNA
- SOFTAIL
- TOURING

*Notice: The prices appearing in this catalog are the manufacturer's suggested retail prices. Actual retail prices may vary.*



# 588 CONTROLS

## Hand Grip & Foot Control Collections

### THE DIAMOND BLACK COLLECTION

Shroud your bike in mystery. This blacked-out hand and foot control collection features distinctive knurled surfaces that expose the raw billet aluminum for a dramatic contrast. Designed to age and “break-in” like a pair of comfortable stone-washed jeans, the satin black finish will complement both high-gloss and “denim” paint colors. The narrow rubber bands and the knurled surfaces provide a positive grip.

#### A. DIAMOND BLACK HAND GRIPS

Hand grips are a comfortable 1.5" diameter and feature “glue-less” installation that can be easily removed for service without damage.

**56405-08** **\$94.95**

Fits '96-later VRSC™, XL, XR, Dyna®, Softail® (except FLSTSE2/3, FLSTNSE and FXSBSE) and '96-'07 Touring models.

**56746-08** **\$99.95**

Fits '08-later Touring, Trike, FLSTSE2/3, FXSBSE and FLSTNSE models.



A. DIAMOND BLACK HAND GRIPS

#### B. DIAMOND BLACK FOOTPEGS AND SHIFTER PEG

The slim footpeg design allows a comfortable pivot point and the wide surface and large diameter end cap keep your boot in place.

**1. 50113-10** Footpegs – Large Diameter. **\$89.95**

Fits models with H-D® male mount-style footpeg supports (except the rider position on '15-later XG, '08-later FXCW, FXCWC, FXS, FXSB, FXSBSE, '07-later XL883N, XL1200N, XL1200T, XL1200V, XL1200X, '07-'10 XL883L, '11-later XL1200C and '08-'13 XR models).

**2. 50911-08A** Footpegs – Small Diameter. **\$84.95**

Fits models with H-D male mount-style footpeg supports (except the rider position on '08-later FXCW, FXCWC, FXS, FXSB, FXSBSE, '07-later XL883N, XL1200N, XL1200T, XL1200V, XL1200X, '07-'10 XL883L, '11-later XL1200C and '08-'13 XR models).

**3. 50695-08A** Footpegs with Wear Peg. **\$89.95**

Fits '07-'10 XL883L, '07-later XL883N, XL1200N, XL1200T and '08-'13 XR models.

**4. 50500035** Footpegs with Styled Wear Peg. **\$89.95**

Fits '12-later XL1200V, '11-later XL883L and XL1200C, '10-later XL1200X, '08-'11 FXCW and FXCWC and '11-later FXS and FXSB models.

**5. 34690-08** Shifter Peg. **\$29.95**

Fits all models (except '06-later VRSC models with forward controls and '08-'13 XR models).



B. DIAMOND BLACK FOOTPEGS AND SHIFTER PEG

#### C. DIAMOND BLACK BRAKE PEDAL PADS

Available in two sizes, these brake pedal pads complete the clean, custom black billet look.

**41850-08** Small. **\$44.95**

Fits '15-later XG, '84-later FX Softail models (except FXSTDSE) and '93-later Dyna models equipped with forward controls.

**46718-08** Large. **\$49.95**

Fits '12-later Dyna FLD, '86-later FL Softail and '80-later Touring and Trike models.



C. DIAMOND BLACK BRAKE PEDAL PADS

#### D. DIAMOND BLACK FOOTBOARD INSERT KIT

Machined from billet aluminum, these footboard inserts retain the cast-in vibration isolation found on the Original Equipment footboards. Kit includes right and left insert.

**50549-08** Rider – Traditional Shape. **\$199.95**

Fits models with traditional-shaped rider footboards.

**50627-08** Passenger – Traditional Shape. **\$179.95**

Fits models equipped with traditional-shaped passenger footboards.



D. DIAMOND BLACK RIDER FOOTBOARD INSERT KIT – TRADITIONAL SHAPE (SHOWN WITH BRAKE PEDAL PAD)



D. DIAMOND BLACK PASSENGER FOOTBOARD INSERT KIT – TRADITIONAL SHAPE

*Notice: The prices appearing in this catalog are the manufacturer's suggested retail prices. Actual retail prices may vary.*

# CONTROLS 589

## Hand Grip & Foot Control Collections



**E. NARROW BAND BILLET HAND GRIPS**



### THE NARROW BAND BILLET COLLECTION

A raw look wrapped in class. This hand and foot control collection features a deep knurled surface for a positive grip and slim black rubber stripes over the chrome finish for stylish contrast. The mirror-chrome finish over the knurled surface scatters light to grab the attention of fellow riders. These components look great next to either chrome or black controls and help you establish your own customizing direction.

### E. NARROW BAND BILLET HAND GRIPS

Continuing the distinctive knurled chrome and rubber band look of the billet footpegs, these hand grips provide a clean, custom look. The end caps are adorned with a Bar & Shield logo.

**56443-00A** **\$94.95**  
Fits '96-later VRSC™, XL, XR, Dyna®, Softail® (except FLSTSE2/3, FLSTNSE and FXSBSE) and '96-'07 Touring models.

### F. NARROW BAND BILLET FOOTPEGS AND SHIFTER PEG

These high-quality, dramatic custom pegs are machined from premium 6061-T6 aluminum, then polished and chrome-plated for long-lasting good looks.

**50978-99A** Footpegs – Small Diameter. **\$84.95**  
Fits models with H-D® male mount-style footpeg supports (except the rider position on '08-later FXCW, FXCWC, FXS, FXSB, FXSBSE, '07-later XL883N, XL1200N, XL1200T, XL1200V, XL1200X, '07-'10 XL883L, '11-later XL1200C and '08-'13 XR models).

**50976-99A** Footpegs – Large Diameter. **\$89.95**  
Fits models with H-D male mount-style footpeg supports (except the rider position on '08-later FXCW, FXCWC, FXS, FXSB, FXSBSE, '07-later XL883N, XL1200N, XL1200T, XL1200V, XL1200X, '07-'10 XL883L, '11-later XL1200C and '08-'13 XR models).

**49254-99** Shifter Peg. **\$29.95**  
Fits all models (except '06-later VRSC models with forward controls and '08-'13 XR models).

### G. NARROW BAND BILLET BRAKE PEDAL PADS

Designed to complement the distinctive knurled chrome and rubber look of the Narrow Band footpegs and hand grips, these brake pedal pads complete the clean, custom billet look.

**42623-00** Large. **\$49.95**  
Fits '12-later Dyna FLD, '86-later FL Softail and '80-later Touring and Trike models.

**42629-00** Small. **\$44.95**  
Fits '15-later XG, '84-later FX Softail models (except FXSTDSE) and '93-later Dyna models equipped with forward controls.

### H. NARROW BAND BILLET FOOTBOARD INSERT KITS

These rider and passenger footboard inserts complete the clean, custom billet look. Machined from billet aluminum and combined with high-durability rubber, these inserts retain the cast-in vibration isolation found in the stock footboard inserts. Kit includes right and left insert.

**51011-01** Rider – Traditional Shape. **\$199.95**  
Fits models with traditional-shaped rider footboards.

**51017-01** Passenger – Traditional Shape. **\$179.95**  
Fits models equipped with traditional-shaped passenger footboards.



**F. NARROW BAND BILLET FOOTPEGS AND SHIFTER PEG**



**G. NARROW BAND BILLET BRAKE PEDAL PADS**



**H. NARROW BAND BILLET RIDER FOOTBOARD INSERTS – TRADITIONAL SHAPE (SHOWN WITH NARROW BAND BRAKE PEDAL PAD)**



**H. NARROW BAND BILLET PASSENGER FOOTBOARD INSERTS – TRADITIONAL SHAPE**



### Model Family Fitment:

- V-ROD
- SPORTSTER
- DYNA
- SOFTAIL
- TOURING

*Notice: The prices appearing in this catalog are the manufacturer's suggested retail prices. Actual retail prices may vary.*



# 590 CONTROLS

## Hand Grip & Foot Control Collections

### CRESTED BAR & SHIELD LOGO COLLECTION

Combine classic styling with contemporary shapes for a one-of-a-kind custom look. Styled to complement the Original Equipment rider footboard on the Softail® Deluxe model, the Crested Bar & Shield Logo Collection adds an "art deco" touch to any model. Rimmed with a smooth band of chrome, the contrasting vivid black rubber pad features a deep slotted design that runs parallel to the length of the motorcycle. Interrupted only by an embossed Bar & Shield logo, the molded rubber pad offers a comfortable and easy-to-clean surface.

#### A. CONTOURED CUSTOM HAND GRIPS

These grips combine a classic hourglass shape for comfort with the style for the new century. The black molded rubber surface with Bar & Shield logo gives plenty of grip, while the chrome end caps add a smooth organic touch.

Fits '96-later VRSC™, XL, XR, Dyna®, Softail® (except FLSTSE2/3, FLSTNSE and FXSBSE) and '96-'07 Touring models.

**56799-04** Small 1.3" Diameter. **\$84.95**

**56459-01A** Medium 1.5" Diameter. **\$84.95**

Fits '08-later Touring, Trike, FLSTSE2/3, FXSBSE and FLSTNSE models.

**56459-08** Medium 1.5" Diameter. **\$89.95**



A. CONTOURED CUSTOM HAND GRIPS

#### B. CRESTED BAR & SHIELD LOGO FOOTPEG KIT

**50576-05** **\$84.95**

Fits models with H-D® male mount-style footpeg supports (except the rider position on '15-later XG, '08-later FXCW, FXCWC, FXS, FXSB, FXSBSE, '07-later XL883N, XL1200N, XL1200V, XL1200X, '07-'10 XL883L, '11-later XL1200C and '08-'13 XR models).

Shown with:

#### CRESTED BAR & SHIELD LOGO SHIFTER PEG

**33946-05** **\$29.95**

Fits all models (except '06-later VRSC models with forward controls and '08-'13 XR models).

#### C. CRESTED BAR & SHIELD LOGO BRAKE PEDAL PADS

**42700-05** Large. **\$49.95**

Fits '12-later Dyna FLD, '86-later FL Softail and '80-later Touring and Trike models.

**42701-05** Small. **\$44.95**

Fits '84-later FX Softail (except FXSTDSE) and '93-later Dyna models equipped with forward controls.

#### D. TAPERED RIDER FOOTBOARD KIT WITH CRESTED BAR & SHIELD LOGO INSERT

Long and lean, the tapered design of these footboards allows maximum flexibility in foot placement for added comfort on long rides. Kit includes left and right tapered footboard pans and rubber isolated deluxe inserts with smooth chrome surround. The inserts feature a slotted rubber design with embossed Bar & Shield logo. Original Equipment on Softail Deluxe models.

**50634-05** **\$149.95**

Fits '86-later FL Softail models.

#### E. TAPERED PASSENGER FOOTBOARD KIT WITH CRESTED BAR & SHIELD LOGO INSERT

Styled to match the rider footboards on the Softail Deluxe model, these Tapered Passenger Footboards feature a crested Bar & Shield logo rubber pad surrounded by a chrome accent. The footboard pan is chrome-plated throughout to add a custom touch, even in the folded position.

**50396-05** **\$219.95**

Fits '86-later Touring, '86-later Softail and '06-later Dyna models equipped with passenger footboard supports. Does not fit Trike models.



B. CRESTED BAR & SHIELD LOGO FOOTPEGS AND SHIFTER PEG



C. CRESTED BAR & SHIELD LOGO BRAKE PEDAL PADS



D. TAPERED RIDER FOOTBOARD KIT WITH CRESTED BAR & SHIELD LOGO INSERT (SHOWN WITH BRAKE PEDAL PAD)



E. TAPERED PASSENGER FOOTBOARD KIT WITH CRESTED BAR & SHIELD LOGO INSERT

*Notice: The prices appearing in this catalog are the manufacturer's suggested retail prices. Actual retail prices may vary.*



**F. FLAME HAND GRIPS**



### FLAME COLLECTION

Styled to carry the "Flame" theme from front to back, this hot collection will get you noticed. The smooth black rubber defines the brilliant chrome "Hot Rod" flame pattern and the dimensional surface adds comfort and grip.

#### F. FLAME HAND GRIPS

These hot new grips will get you noticed. Smooth rubber is molded into the machined billet grip and defines the chrome "Hot Rod" flame. The grips are simple to install and the "glueless" design allows removal without damage.

**56518-02** **\$94.95**

Fits '96-later VRSC™, XL, XR, Dyna®, Softail® (except FLSTSE2/3, FLSTNSE and FXSBSE) and '96-'07 Touring models.

**56518-08** **\$99.95**

Fits '08-later Touring, Trike, FLSTSE2/3, FXSBSE and FLSTNSE models.

#### G. FLAME FOOTPEGS

Footpeg rotation is adjustable for position, so your feet ride on the rubber treads whether used as a rider, passenger or highway peg. Kit includes left and right peg.

**50312-03** **\$84.95**

Fits models with H-D® male mount-style footpeg supports (except the rider position on '15-later XG, '08-later FXCW, FXCWC, FXS, FXSB, FXSBSE, '07-later XL883N, XL1200N, XL1200T, XL1200V, XL1200X, '07-'10 XL883L, '11-later XL1200C and '08-'13 XR models).

#### Shown with:

##### FLAME SHIFTER PEG

This easy-to-install shifter peg can be rotated to a comfortable position and the smooth back protects the toe of your boot from wear while shifting.

**34617-03** **\$29.95**

Fits all models (except '06-later VRSC models with forward controls and '08-'13 XR models).

#### H. FLAME BRAKE PEDAL PADS

Available in two sizes to fit most Harley-Davidson® motorcycles, these easy-to-install brake pedal pads complement the Flame Collection pegs and footboard inserts for a complete look.

**42554-03** Large. **\$49.95**

Fits '12-later Dyna FLD, '86-later FL Softail and '80-later Touring and Trike models.

**42841-03** Small. **\$44.95**

Fits '84-later FX Softail models (except FXSTDSE) and '93-later Dyna models equipped with forward controls.

#### I. FLAME FOOTBOARD INSERTS

Easy-to-install footboard kits retain the Original Equipment cast-in vibration isolation for a fatigue-free ride. Kit includes left and right insert.

**50295-02** Rider – Traditional Shape. **\$99.95**

Fits models with traditional-shaped rider footboards.

**50310-02** Passenger – Traditional Shape. **\$89.95**

Fits models equipped with traditional-shaped passenger footboards.



**G. FLAME FOOTPEGS AND SHIFTER PEG**



**H. FLAME BRAKE PEDAL PADS**



**I. FLAME RIDER FOOTBOARD INSERTS – TRADITIONAL SHAPE (SHOWN WITH LARGE FLAME BRAKE PEDAL PAD)**



**I. FLAME PASSENGER FOOTBOARD INSERTS – TRADITIONAL SHAPE**



#### Model Family Fitment:

- V-ROD
- SPORTSTER
- DYNA
- SOFTAIL
- TOURING

*Notice: The prices appearing in this catalog are the manufacturer's suggested retail prices. Actual retail prices may vary.*



# 592 CONTROLS

## Hand Grip & Foot Control Collections

### WILLIE G SKULL COLLECTION

The deep black rubber pads are set against a brilliant polished and chrome-plated field to yield the dramatic appearance of the Skull Collection.

#### A. WILLIE G SKULL HAND GRIPS

Contrasting the chrome sinister skull logo surrounded by "Harley-Davidson" script, the raised rubber pads add positive grip and comfort for the long haul. Easy to install, these grips feature a "glueless" design that allows removal without damage.

Fits '96-later VRSC™, XL, XR, Dyna®, Softail® (except FLSTSE2/3, FLSTNSE and FXSBSE) and '96-'07 Touring models.

<b>56751-04</b>	Small 1.3" Diameter.	<b>\$94.95</b>
<b>56740-04</b>	Medium 1.5" Diameter.	<b>\$94.95</b>
<b>56741-04</b>	Large 1.6" Diameter.	<b>\$94.95</b>

Fits '08-later Touring, Trike, FLSTSE2/3, FXSBSE and FLSTNSE models.

<b>56740-08</b>	Medium 1.5" Diameter.	<b>\$99.95</b>
-----------------	-----------------------	----------------

#### B. WILLIE G SKULL FOOTPEGS

Footpeg rotation is adjustable for position, so your feet ride on the rubber treads whether used as a rider, passenger or high-way peg. Kit includes left and right peg.

<b>50370-04</b>		<b>\$84.95</b>
-----------------	--	----------------

Fits models with H-D® male mount style footpeg supports (except the rider position on '15-later XG, '08-later FXCW, FXCWC, FXS, FXSB, FXSBSE, '07-later XL883N, XL1200N, XL1200T, XL1200V, XL1200X, '07-'10 XL883L, '11-later XL1200C and '08-'13 XR models).

#### Shown with:

#### WILLIE G SKULL SHIFTER PEG

This easy-to-install shifter peg can be rotated to a comfortable position and the smooth back protects the toe of your boot from wear while shifting.

<b>34689-04</b>		<b>\$29.95</b>
-----------------	--	----------------

Fits all models (except '06-later VRSC models with forward controls and '08-'13 XR models).

#### C. WILLIE G SKULL BRAKE PEDAL PADS

Available in two sizes to fit most Harley-Davidson® motorcycles, these easy-to-install brake pedal pads complement Willie G Collection pegs and footboard inserts for a complete look.

<b>42711-04</b>	Large.	<b>\$69.95</b>
-----------------	--------	----------------

Fits '12-later Dyna FLD, '86-later FL Softail and '80-later Touring and Trike models.

<b>42710-04</b>	Small.	<b>\$59.95</b>
-----------------	--------	----------------

Fits '84-later FX Softail (except FXSTDSE) and '93-later Dyna models equipped with forward controls.

#### D. WILLIE G SKULL HEEL REST PEGS

<b>34699-04</b>		<b>\$59.95</b>
-----------------	--	----------------

Fits models equipped with Rider Footpeg Heel Rests P/N 50227-01.

#### E. WILLIE G SKULL FOOTBOARD INSERTS

Easy-to-install footboard kits retain the Original Equipment cast-in vibration isolation for a fatigue-free ride. Kit includes left and right insert.

<b>50704-04</b>	Rider – Swept Wing Shape.	<b>\$99.95</b>
-----------------	---------------------------	----------------

Fits '12-later Dyna FLD and '86-later Softail and Touring models equipped with Swept Wing-Shaped rider footboards. Does not fit Trike models.

<b>50710-04</b>	Rider – Traditional Shape.	<b>\$99.95</b>
-----------------	----------------------------	----------------

Fits models with traditional-shaped rider footboards.

<b>50713-04</b>	Passenger – Traditional Shape.	<b>\$89.95</b>
-----------------	--------------------------------	----------------

Fits models equipped with traditional-shaped passenger footboards.



A. WILLIE G SKULL HAND GRIPS



B. WILLIE G SKULL FOOTPEGS AND SHIFTER PEG



C. WILLIE G SKULL BRAKE PEDAL PADS



D. WILLIE G SKULL HEEL REST PEGS



E. WILLIE G SKULL RIDER FOOTBOARD INSERTS – SWEEP WING SHAPE



E. WILLIE G SKULL RIDER FOOTBOARD INSERTS – TRADITIONAL SHAPE (SHOWN WITH WILLIE G BRAKE PEDAL PAD)



E. WILLIE G SKULL PASSENGER FOOTBOARD INSERTS – TRADITIONAL SHAPE

Notice: The prices appearing in this catalog are the manufacturer's suggested retail prices. Actual retail prices may vary.

# CONTROLS 593

Hand Grip & Foot Control Collections



F. NOSTALGIC HAND GRIPS – BLACK



## NOSTALGIC COLLECTION

With a serious nod to the past, the Nostalgic Collection applies a fresh twist to a classic design. The chrome surround and raised rubber shapes outline the historic round shield and name band that has been at the center of Harley-Davidson® Original Equipment footboards for years. The classic look extends to the matching hand grips that feature the classic "bicycle grip" shape. This easy-to-install collection is the ideal match for your traditional styling direction.

### F. NOSTALGIC HAND GRIPS – BLACK

Comfortable nostalgic hourglass style with a chrome accent ring and a molded-in "Harley-Davidson" logo. These rubber grips were inspired by Harley-Davidson® motorcycles of the 1940s.

**56275-96B** **\$64.95**  
Fits '96-later VRSC™, XL, XR, Dyna®, Softail® (except FLSTSE2/3, FLSTNSE and FXSBSE) and '96-'07 Touring models.

**56275-08** **\$69.95**  
Fits '08-later Touring, Trike, FLSTSE2/3, FXSBSE and FLSTNSE models.

### G. NOSTALGIC SHIFTER PEG

This easy-to-install shifter peg can be rotated to a comfortable position and the smooth back protects the toe of your boot from wear while shifting.

**34627-99** **\$29.95**  
Fits all models (except '06 later VRSC models with forward controls and '08-'13 XR models).

### H. NOSTALGIC BRAKE PEDAL PAD

These easy-to-install brake pedal pads complement the Nostalgic Collection pegs and footboard inserts for a complete look.

**44248-96** **\$44.95**  
Fits '12-later Dyna FLD, '86-later FL Softail and '80-later Touring and Trike models.

### I. NOSTALGIC FOOTBOARD INSERT KITS

Quick, easy replacement of stock rubber footboard insert. Made from stamped chrome-plated steel and high-durability rubber. Retains cast-in vibration isolation found in stock footboard inserts. Kit includes left and right insert.

**50187-96** Rider – Traditional Shape. **\$99.95**  
Fits '12-later Dyna FLD and '86-later FL Softail, Touring and Trike models equipped with traditional-shaped rider footboards.

**50190-96** Passenger – Traditional Shape. **\$89.95**  
Fits models equipped with traditional-shaped passenger footboards.

**50051-09** Rider – Half-Moon Shape. **\$149.95**  
Fits '86-later Softail models equipped with Half Moon-shaped rider footboards.

**50027-09** Passenger – Half-Moon Shape. **\$129.95**  
Fits '06-later Dyna, '00-later Softail and '86-later Touring models equipped with Half Moon-shaped passenger footboards. Does not fit Trike models.



G. NOSTALGIC SHIFTER PEG



H. NOSTALGIC BRAKE PEDAL PAD



I. NOSTALGIC RIDER FOOTBOARD INSERTS – TRADITIONAL SHAPE (SHOWN WITH BRAKE PEDAL PAD)



I. NOSTALGIC PASSENGER FOOTBOARD INSERTS – TRADITIONAL SHAPE



I. NOSTALGIC RIDER FOOTBOARD INSERTS – HALF-MOON SHAPE (SHOWN WITH NOSTALGIC BRAKE PEDAL PAD)



I. NOSTALGIC PASSENGER FOOTBOARD INSERTS – HALF-MOON SHAPE



#### Model Family Fitment:

- V-ROD
- SPORTSTER
- DYNA
- SOFTAIL
- TOURING

Notice: The prices appearing in this catalog are the manufacturer's suggested retail prices. Actual retail prices may vary.



# 594 CONTROLS

## Hand Grip & Foot Control Collections

### CHROME AND RUBBER COLLECTION

Chrome and rubber both have their distinct places in the world of motorcycle styling. It seemed natural to bring the two together to create this unique collection.

#### A. CHROME AND RUBBER HAND GRIPS

Designed to match the Chrome and Rubber Footboard Inserts and Brake Pedal Pads, these grips are made from an injected rubber molding process that combines chromed steel and durable rubber.

Fits '96-later VRSC™, XL, XR, Dyna®, Softail® (except FLSTSE2/3, FLSTNSE and FXSBSE) and '96-'07 Touring models.

<b>56246-96A</b>	Small.	<b>\$84.95</b>
<b>56263-96A</b>	Large.	<b>\$84.95</b>

Fits '08-later Touring, Trike, FLSTSE2/3, FXSBSE and FLSTNSE models.

<b>56246-08</b>	Small.	<b>\$89.95</b>
<b>56263-08</b>	Large.	<b>\$89.95</b>

Fits '82-'95 models. Kit includes adhesive required for installation.

<b>56241-96</b>	Small.	<b>\$84.95</b>
-----------------	--------	----------------



A. CHROME AND RUBBER HAND GRIPS

#### B. CHROME AND RUBBER CUSTOM FOOTPEGS AND SHIFTER PEG

Fits models with H-D® male mount-style footpeg supports (except the rider position on '15-later XG, '07-later XL883L, XL883N, XL1200N, XL1200T, XL1200V, XL1200X, '11-later XL1200C, '08-later FXCW, FXCWC, FXS, FXSB, FXSBSE, '06-later Dyna and '03-later Sportster® models).

<b>50500-03</b>	Oversize.	<b>\$89.95</b>
-----------------	-----------	----------------

Fits all models in passenger and highway peg positions.

<b>50130-95A</b>	Large.	<b>\$84.95</b>
<b>50131-95A</b>	Small.	<b>\$84.95</b>

Fits all models (except '06-later VRSC models with forward controls and 08-'13 XR models).

<b>34608-95</b>	Shifter Peg.	<b>\$29.95</b>
-----------------	--------------	----------------



B. CHROME AND RUBBER CUSTOM FOOTPEGS AND SHIFTER PEG

#### C. CHROME AND RUBBER BRAKE PEDAL PADS

**42478-95** Large. **\$49.95**  
Fits '12-later Dyna FLD, '86-later FL Softail and '80-later Touring and Trike models.

**42476-95** Small. **\$44.95**  
Fits '84-later FX Softail models (except FXSTDSE) and '93-later Dyna models equipped with forward controls.



C. CHROME AND RUBBER BRAKE PEDAL PADS

#### D. CHROME AND RUBBER FOOTBOARD INSERTS

**50176-95** Rider – Traditional Shape. **\$99.95**  
Fits '12-later Dyna FLD and '86-later FL Softail, Touring and Trike models equipped with traditional-shaped rider footboards.

**50177-95** Passenger – Traditional Shape. **\$89.95**  
Fits models equipped with traditional-shaped passenger footboards.



D. CHROME AND RUBBER RIDER FOOTBOARD INSERTS – TRADITIONAL SHAPE (SHOWN WITH BRAKE PEDAL PAD)



D. CHROME AND RUBBER PASSENGER FOOTBOARD INSERTS – TRADITIONAL SHAPE

*Notice: The prices appearing in this catalog are the manufacturer's suggested retail prices. Actual retail prices may vary.*

# CONTROLS 595

Hand Grip & Foot Control Collections



**E. HEEL RAISER FOOTPEG KIT**

**E. HEEL RAISER FOOTPEG KIT**

Comfort and cool, clean looks in one. Heel Raiser Chrome and Rubber Footpegs provide a large surface area that lets you change foot position for maximum comfort and the fold-out heel rest provides footboard-style support that relieves calf and thigh tension on the highway. The heel rest can be deployed or retracted with your boot while riding. The sole-gripping horizontal black rubber bands complement the mirror-chrome finish and add vibration isolation and a rich appearance to the pegs. Heel Raiser mounts to the standard H-D® style footpeg support, so it can be used in many rider and passenger applications.

**50178-09 \$199.95**

Fits H-D® male mount-style footpeg supports (except the rider position on mid-control models, '02-later VRSC™, '15-later XG, '07-later, XL1200N, XL1200T, XL1200V, XL1200X, '11-later XL1200C, FLS, '08-later FXCW, FXCWC, FXS, FXSB, FXSBSE and passenger position on Softail® models). Fits mid-control models in the highway peg or engine guard position on XL and Dyna® models. Does not fit with Adjustable Passenger Footpeg Support P/N 50763-09 and 50787-09 or Whiskers Highway Peg Mount 50855-09 and 50865-09.



**F. MINI FOOTBOARD KIT**

**F. MINI FOOTBOARD KIT**

**F. MINI FOOTBOARD KIT**

This Mini Footboard Kit can be installed in place of traditional footpegs and provides a little additional leg support and more options to move your feet around on a long run. Mini Footboards mount to standard H-D style footpeg supports and can be used in many rider and passenger applications. A little larger than a bicycle pedal, Footboards can be pivoted to the proper angle for maximum riding comfort. The sole-gripping horizontal black rubber bands complement the mirror-chrome finish and add vibration isolation and a rich appearance to the pegs. Complete the look with Shifter Pegs and Brake Pedal Pads from the Chrome and Rubber Collection.

**Fits rider position:**

VRSC models with forward controls (except VRSCDX and VRSCF), '06-earlier XL, '07-'10 XL883, XL883R, XL883C, XL1200C, XL1200R and '07-'11 XL1200L, Dyna models (except FLD) and Softail models with forward controls (except FXCW, FXCWC, FXS, FXSB or FXSBSE).

**Fits passenger position:**

All models with H-D male-mount passenger peg mounts (except '06-earlier VRSC, '03-earlier XL, '05-earlier Dyna and Softail models equipped with Shotgun exhaust). Softail models require separate purchase of Support Kit P/N 50454-09.

**Fits highway peg position:**

All models with frame-mount or engine guard-mount highway pegs (except Whiskers Adjustable Highway Bar P/N 50855-09 and 50865-09).

**50451-09 \$109.95**

**G. CUSTOM FOOTPEGS AND SHIFTER PEG**

This footpeg grouping is chrome-plated and features a zinc die-cast body with steel shaft. The black rubber pads have "Harley-Davidson" graphics molded-in for rich detail. Allen® wrench included.

**1. 50915-90T Footpegs – Large Diameter. \$54.95**

Fits models with H-D male mount-style footpeg supports (except the rider position on '15-later XG, '08-later FXCW, FXCWC, FXS, FXSB, FXSBSE, '07-later, XL883N, XL1200N, XL1200T, XL1200V, XL1200X, '07-'10 XL883L, '11-later XL1200C and '08-'13 XR models).

**2. 50916-90T Footpegs – Small Diameter. \$49.95**

Fits models with H-D male mount-style footpeg supports (except the rider position on '07-later XL883L, XL883N, XL1200N, XL1200V, XL1200X, '11-later XL1200C, '08-later FXCW, FXCWC, FXS, FXSB, FXSBSE, '06-later Dyna and '03-later Sportster® models).

**3. 34635-90T Custom Shifter Peg. \$19.95**

Fits all models (except '06-later VRSC models with forward controls and '08-'13 XR models).



**G. CUSTOM FOOTPEGS AND SHIFTER PEG**

**Model Family Fitment:**

- V-ROD
- SPORTSTER
- DYNA
- SOFTAIL
- TOURING

*Notice: The prices appearing in this catalog are the manufacturer's suggested retail prices. Actual retail prices may vary.*



# 596 CONTROLS

Hand Grip & Foot Control Collections

## THE STREAMLINER COLLECTION – HAND GRIPS

Inspired by the art-deco designs of the Streamliner era, this collection reflects the simple lines and shapes that still remain contemporary today. The rich black rubber features three raised chrome tri-line bands for contrast and a rich chrome surround to finish the look.

### A. STREAMLINER HAND GRIPS

Complement the Streamliner look with these matching grips. The rich black rubber provides a positive grip while riding and the chrome tri-line design will provide just the right touch of chrome.

**56100048** **\$99.95**

Fits '08-later Touring, Trike, FLSTSE2/3, FXSBSE and FLSTNSE models.

### B. STREAMLINER FOOTPEG KIT

Complete the streamlined look with Streamliner Footpegs. Kit includes left and right footpegs.

**50211-04** **\$159.95**

Fits rider positions on '03-earlier XL models with mid-controls and '05-earlier Dyna® models with mid-controls. Fits all models in passenger and highway peg positions.

Shown with:

### STREAMLINER SHIFTER PEG

Complement the streamlined footpegs and footboards with this simple-to-install Shifter Peg.

**34967-04** **\$29.95**

Fits all models (except '06-later VRSC™ models with forward controls and '08-'13 XR models).

### C. STREAMLINER BRAKE PEDAL PAD

Complement the streamlined footpegs and footboards with this simple-to-install Brake Pedal Pad. The chrome frame surrounds a black rubber pad accented with three chrome bands for style and grip.

**42712-04** Large. **\$59.95**

Fits '12-later Dyna FLD, '86-later FL Softail® and '80-later Touring and Trike models.

### D. STREAMLINER RIDER FOOTBOARD KIT

Add the sleek sweeping footboard design from the Street Glide® to your Touring bike. Kit includes vibration-isolation footboard pads with three chrome bands, and the complete chrome-plated pans that easily bolt in place of the Original Equipment footboards.

**50631-04** **\$229.95**

Fits '12-later Dyna FLD and '86-later FL Softail (except FLS and FLSTFB), Touring and Trike models (except FLHTKL and FLHTCUL).

### E. STREAMLINER PASSENGER FOOTBOARD INSERT KIT – SWEEP WING SHAPE

Styled to match the Street Glide® model's Original Equipment Streamliner Rider Footboards. Featuring vibration-isolation rubber inserts with three chrome bands, this insert is designed to fit the Swept Wing shape passenger footboard pan. Kit includes left and right side insert.

**50420-05** **\$89.95**

Fits '06-later Dyna, '00-later Softail and '86-later Touring models equipped with Swept Wing-shaped passenger footboards. Does not fit Trike models. If installed on models equipped with Passenger Footboard Support kit P/N 50399-07A, footboards will not remain in flipped up position.



A. STREAMLINER HAND GRIPS



B. STREAMLINER FOOTPEGS AND SHIFTER PEG



C. STREAMLINER BRAKE PEDAL PAD



D. STREAMLINER RIDER FOOTBOARD KIT (SHOWN WITH BRAKE PEDAL PAD AND FOOTPEG KIT)



E. STREAMLINER PASSENGER FOOTBOARD INSERTS – SWEEP WING SHAPE

Notice: The prices appearing in this catalog are the manufacturer's suggested retail prices. Actual retail prices may vary.

# CONTROLS 597

Hand Grip & Foot Control Collections



F. HAND GRIP DECORATIVE END CAPS – FLAME

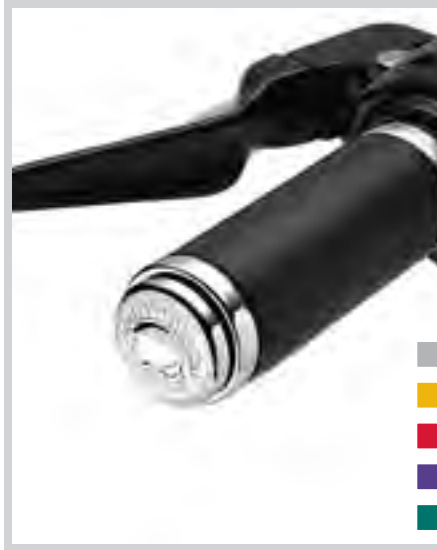

F. HAND GRIP DECORATIVE END CAPS – SKULL

## F. HAND GRIP DECORATIVE END CAPS

Throw some attitude onto your Smooth Leather, Custom Print Leather or Chrome and Rubber Horizontal Hand Grips. These easy-to-install caps replace the originals and take customization to a whole new level.

Fits Contoured Chrome and Rubber Custom Hand Grips P/N 56459-01A, Chrome and Rubber Horizontal Hand Grips P/N 56246-96A, 56263-96A, 56241-96 and 56258-96, Flame Hand Grips P/N 56518-02, Diamond Plate Hand Grips P/N 56688-04 and Smooth Leather Hand Grips P/N 56197-98A.

<b>56676-02</b>	Flame End Caps.	<b>\$19.95</b>
<b>56658-00</b>	Skull End Caps.	<b>\$19.95</b>

## G. O-RING FOOTPEGS AND SHIFTER PEG WITH ETCHED BAR & SHIELD LOGO

**1. 49149-84A** Shifter Peg. **\$19.95**

Fits all models (except '06-later VRSC™ models with forward controls, '08-'13 XR models or '06-later Dyna® models with forward controls).

**2. 49128-82** Footpegs. **\$44.95**

Fits models with H-D® male mount-style footpeg supports (except the rider position on '07-later XL883L, XL883N, XL1200N, XL1200T, XL1200V, XL1200X, '11-later XL1200C, '08-later FXCW, FXCWC, FXS, FXSB, FXSBSE, '06-later Dyna and '03-later Sportster® models).

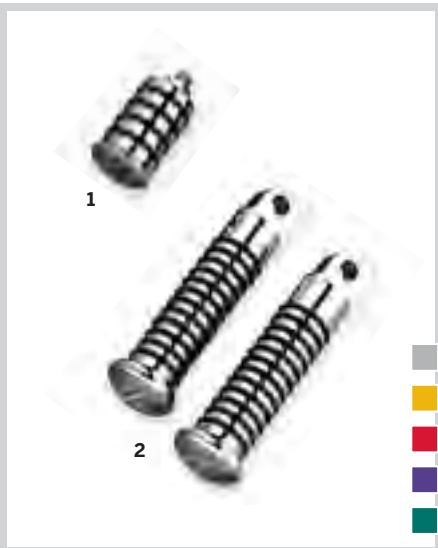

G. O-RING FOOTPEGS AND SHIFTER PEG WITH ETCHED BAR & SHIELD LOGO

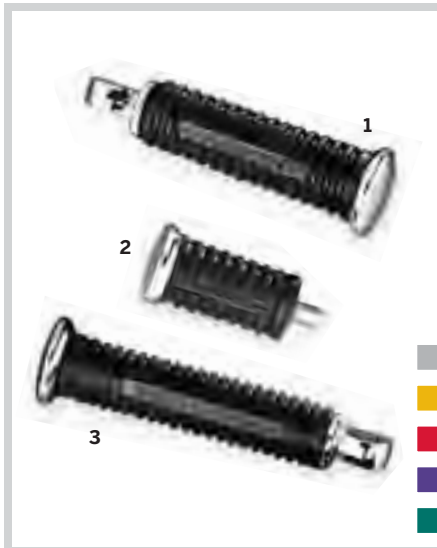

H. FOOTPEGS AND SHIFTER PEG WITH CHROME END COVER

## H. FOOTPEGS AND SHIFTER PEG WITH CHROME END COVER

Footpegs feature cushioned rubber tread for sure-footed comfort and the chrome end cap adds a touch of style.

**1. 49117-77TB** Footpegs – Small Diameter. **\$39.95**

Fits models with H-D® male mount-style footpeg supports (except the rider position on '07-later XL883L, XL883N, XL1200N, XL1200V, XL1200X, '11-later XL1200C, '08-later FXCW, FXCWC, FXS, FXSB, FXSBSE, '06-later Dyna and '03-later Sportster models).

**2. 34633-85T** Shifter Peg. **\$12.95**

Fits all models (except '06-later VRSC models with forward controls and '08-'13 XR models).

**3. 49500-92T** 5.0" Extended Footpegs. **\$44.95**

Fits models with H-D male mount-style footpeg supports (except the rider position on '08-later FXCW, FXCWC, FXS, FXSB, FXSBSE, '07-later XL883N, XL1200N, XL1200T, XL1200V, XL1200X, '07-'10 XL883L, '11-later XL1200C and '08-'13 XR models).

## I. LARGE CUSHIONED FOOTPEG KIT

Large diameter footpegs feature cushioned rubber tread for sure-footed comfort.

**49110-98** **\$44.95**

Fits models with H-D male mount-style footpeg supports (except the rider position on '08-later FXCW, FXCWC, FXS, FXSB, FXSBSE, '07-later XL883N, XL1200N, XL1200V, XL1200X, '07-'10 XL883L, '11-later XL1200C and '08-'13 XR models).



I. LARGE CUSHIONED FOOTPEG KIT



J. REPLACEMENT FOOTBOARD MATS

## J. REPLACEMENT FOOTBOARD MATS

**50614-91A** **\$29.95**

Fits all isolator-type footboards. Stock on '91-'05 models.

Model Family Fitment:

V-ROD	SPORTSTER	DYNA
SOFTAIL	TOURING	

Notice: The prices appearing in this catalog are the manufacturer's suggested retail prices. Actual retail prices may vary.



# 598 CONTROLS

## Footboards

### CUSTOM FOOTBOARDS

To add style to your ride, install custom footboard inserts that match the shape of your Original Equipment footboards. To radically change the look, select footboard pans in a new shape or finish and add coordinating inserts that highlight your custom direction.

#### A. SWEEP WING RIDER FOOTBOARD PANS – CHROME

Add a sleek tapered look to your footboard-equipped model. These chrome-plated Swept Wing Pans are installed using the Original Equipment mounts and hardware. Add your choice of Swept-Wing Shaped footboard inserts (sold separately).

Fits '12-later Dyna® FLD and '86-later FL Softail® (except FLS and FLSTFB), Touring and Trike models (except FLHTKL and FLHTCUL).

<b>50683-04</b>	Right.	<b>\$59.95</b>
<b>50688-04</b>	Left.	<b>\$59.95</b>



**A. SWEEP WING RIDER FOOTBOARD PANS – CHROME (SHOWN WITH STREAMLINER INSERT)**



**A. SWEEP WING RIDER FOOTBOARD PANS – CHROME**

#### B. BLACK RIDER FOOTBOARD PANS

Complete the blacked-out transformation. Replace the Original Equipment chrome footboard pans with sinister gloss black. Kit includes both the right and left pan and is installed using the Original Equipment hardware and insert pad. Custom footboard inserts are sold separately.

Fits '12-later Dyna FLD and '86-later FL Softail (except FLS and FLSTFB), Touring and Trike models (except FLHTKL and FLHTCUL).

<b>51322-08</b>	Traditional Shape.	<b>\$89.95</b>
<b>51060-08</b>	Swept Wing Shape.	<b>\$89.95</b>



**B. BLACK RIDER FOOTBOARD PANS – TRADITIONAL SHAPE**



**B. BLACK RIDER FOOTBOARD PANS – SWEEP WING SHAPE**

#### C. HALF-MOON RIDER FOOTBOARDS

Combine the style of the '40s with the comfort of today. The classic half moon-shaped rider footboards are available in polished stainless steel or gloss black finish to complement your styling direction. The traditional "Harley-Davidson" rubber insert features a vibration-isolation design for a long, comfortable ride. Kit includes left and right footboard pans and matching rubber inserts.

Fits '86-later FL Softail models.

<b>51345-08</b>	Polished Stainless.	<b>\$149.95</b>
<b>51400-08</b>	Gloss Black.	<b>\$149.95</b>



**C. HALF-MOON RIDER FOOTBOARDS – POLISHED STAINLESS**



**C. HALF-MOON RIDER FOOTBOARDS – POLISHED STAINLESS**

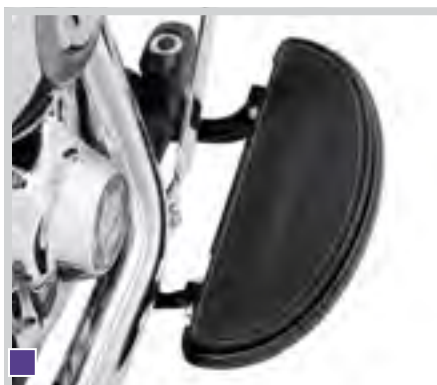

**C. HALF-MOON RIDER FOOTBOARDS – GLOSS BLACK**



**C. HALF-MOON RIDER FOOTBOARDS – GLOSS BLACK**

*Notice: The prices appearing in this catalog are the manufacturer's suggested retail prices. Actual retail prices may vary.*

# CONTROLS 599

Footboards



D. FLHX PASSENGER FOOTBOARD PANS

## D. FLHX PASSENGER FOOTBOARD PANS

Combine passenger comfort with a sinister blacked-out style. These unique Swept Wing Rider Footboard Pans complement the Swept Wing Rider Footboard shape and allow you to replace the Original Equipment FLHX passenger footpegs with footboards. When folded, the footboards showcase the rich black anodized finish and machined aluminum tri-line FLHX highlights. Kit includes left and right footboard pans. Footboard pans accept Original Equipment or custom accessory Swept Wing footboard inserts (sold separately). Footboard supports required.

**50500041** **\$169.95**  
Fits '86-later Touring, '00-later Softail® and '06-later Dyna® models equipped with passenger footboard supports. Does not fit Trike models.



E. SWEPT WING PASSENGER FOOTBOARD PANS – GROOVED

E. SWEPT WING PASSENGER FOOTBOARD PANS – SMOOTH

## E. SWEPT WING PASSENGER FOOTBOARD PANS

These unique Swept Wing Passenger Footboard Pans complement the Swept Wing Rider Footboard shape and allow you to replace the Original Equipment passenger footpegs on certain models with footboards. When folded, the footboard displays a mirror-chrome surface in your choice of smooth or ball-milled grooved design. Footboard inserts and footboard supports sold separately.

Fits '86-later Touring, '00-later Softail and '06-later Dyna models equipped with passenger footboard supports. Does not fit Trike models.

**50357-04** Chrome – Grooved. **\$169.95**  
**50716-04** Chrome – Smooth. **\$159.95**

## F. HALF-MOON PASSENGER FOOTBOARD PANS AND INSERTS

Styled to match the Half-Moon Rider Footboards, these classic passenger footboards add both style and comfort to your nostalgic ride. Available in mirror-chrome or gloss black finish, the kit includes left and right footboard pan and vibration-isolation footboard inserts. Model-specific footboard mounts are sold separately.

Fits '86-later Touring, '00-later Softail and '06-later Dyna models equipped with passenger footboard supports. Does not fit Trike models.

**50807-08** Chrome. **\$189.95**  
**50810-08** Gloss Black. **\$179.95**



F. HALF-MOON PASSENGER FOOTBOARD PANS – CHROME



F. HALF-MOON PASSENGER FOOTBOARD PANS – GLOSS BLACK

### Model Family Fitment:

- V-ROD
- SPORTSTER
- DYNA
- SOFTAIL
- TOURING

*Notice: The prices appearing in this catalog are the manufacturer's suggested retail prices. Actual retail prices may vary.*



# 600 CONTROLS

## Footboards

### A. CHROME PASSENGER FOOTBOARD PANS

Replace the factory black painted passenger footboard with the custom look of smooth chrome. The kit includes left- and right-hand traditional D-shaped footboard pans, chrome-plated and ready to install with your Original Equipment hardware. Just add your choice of footboard insert for the finishing touch. Footboard supports sold separately.

**50752-04** **\$169.95**

Fits '86-later Touring and Trike, '00-later Softail® and '06-later Dyna® models equipped with passenger footboard supports.

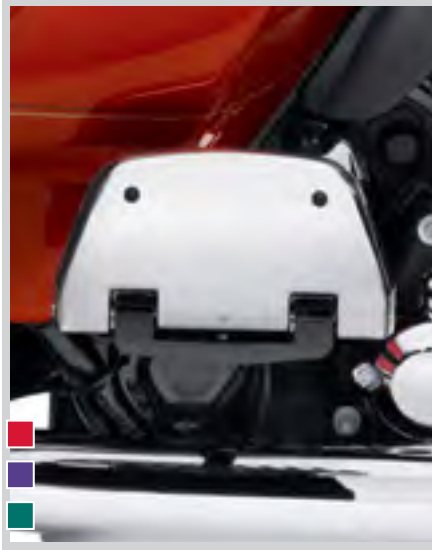

A. CHROME PASSENGER FOOTBOARD PANS

### B. MINI FOOTBOARD KIT

This footboard kit can be installed in place of traditional footpegs and provides a little additional leg support and more options to move your legs around on a long ride. Mini Footboards mount to the standard H-D® style footpeg supports and can be used in many rider, passenger and highway peg applications. Sole-gripping rubber complements Original Equipment or accessory footboards and footpegs and adds vibration isolation and a rich appearance.

#### Fits rider position:

VRSC™ models with forward controls (except VRSCDX and VRSCF), '06-earlier XL, '07-'10 XL883, XL883R, XL883C, XL1200C, XL1200R and '07-'11 XL1200L, Dyna (except FLD) and Softail models with forward controls (except FXCW, FXCWC, FXS, FXSB or FXSBSE).

#### Fits passenger position:

All models with H-D male-mount passenger peg mounts (except '06-earlier VRSC, '03-earlier XL, '05-earlier Dyna and Softail models equipped with Shotgun exhaust). Softail models require separate purchase of Support Kit P/N 50454-09.

#### Fits highway peg position:

All models with frame-mount or engine guard-mount highway pegs (except Whiskers Adjustable Highway Bar P/N 50855-09 and 50865-09).

**50500139** Small 3.0" – Chrome. **\$129.95**

**50500144** Small 3.0" – Gloss Black. **\$129.95**

**50500109** Large 4.0" – Chrome. **\$129.95**

**50500124** Large 4.0" – Gloss Black. **\$129.95**

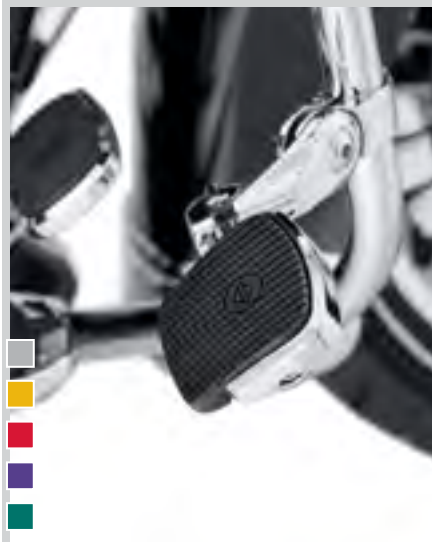

B. MINI FOOTBOARD KIT – LARGE CHROME



B. MINI FOOTBOARD KIT – LARGE GLOSS BLACK



B. MINI FOOTBOARD KIT

*Notice: The prices appearing in this catalog are the manufacturer's suggested retail prices. Actual retail prices may vary.*

# CONTROLS 601

## Highway Pegs



**C. BILLET ENGINE GUARD FOOTPEG MOUNTING KIT – CHROME**



**C. BILLET ENGINE GUARD FOOTPEG MOUNTING KIT – GLOSS BLACK**

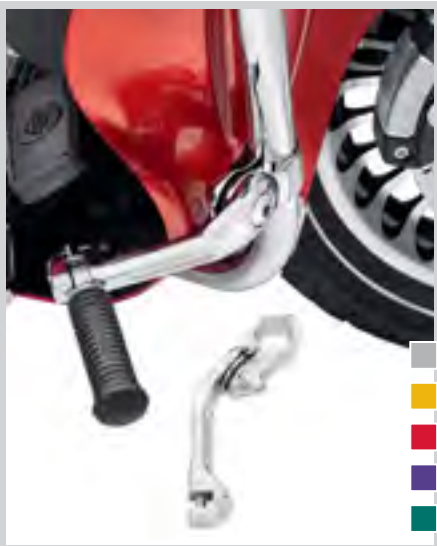

**D. ADJUSTABLE HIGHWAY PEG MOUNTING KIT – LONG ANGLED – CHROME**



**D. ADJUSTABLE HIGHWAY PEG MOUNTING KIT – SHORT ANGLED – CHROME**

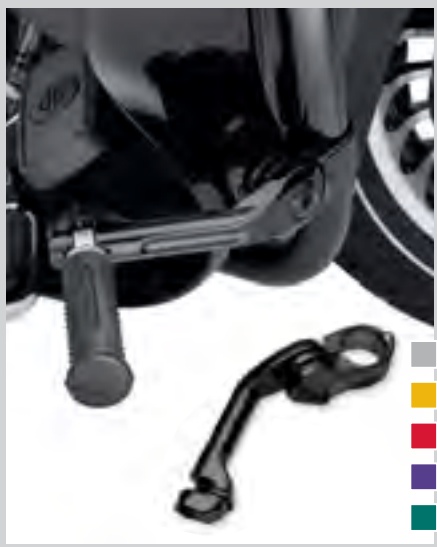

**D. ADJUSTABLE HIGHWAY PEG MOUNTING KIT – LONG ANGLED – GLOSS BLACK**

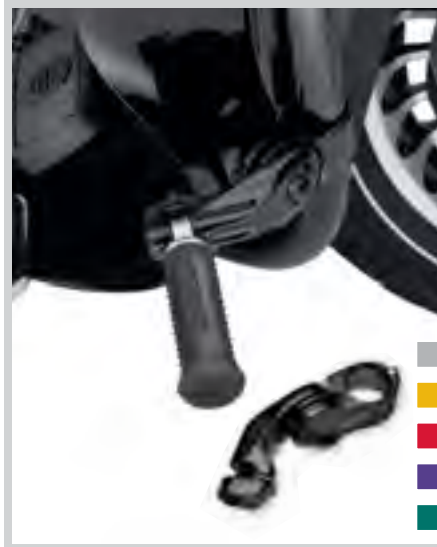

**D. ADJUSTABLE HIGHWAY PEG MOUNTING KIT – SHORT ANGLED – GLOSS BLACK**

### C. BILLET ENGINE GUARD FOOTPEG MOUNTING KIT\*

Here's a stylish way to get your feet into the wind. This beautifully polished Billet Aluminum Footpeg Mount Kit installs easily on your engine guard and lets you stretch your legs on cross-country rides. Available in your choice of chrome or gloss black finishes. Works with all H-D® style male-mount footpegs.

Fits front engine guards with 1.25" diameter tubing (except VRSC™ Engine Guard P/N 49267-01A, 49388-09, XL Engine Guard P/N 49060-04, 49287-11, 49215-07 or Softail® Nostalgic Engine Guard P/N 49037-05A). Requires separate purchase of Chrome Bullet Tip Footpeg Bolt Kit P/N 94133-01.

<b>50957-02B</b>	Chrome.	<b>\$99.95</b>
<b>54234-10</b>	Gloss Black.	<b>\$99.95</b>

### D. ADJUSTABLE HIGHWAY PEG MOUNTING KIT – ANGLED\*

Stretch out for added comfort. This Adjustable Highway Peg Mounting Kit can be set for shorter riders and it can be reversed to reach far forward for those with long legs. The angled design allows the arm to reach back and around to clear fairing lowers. The arm can be raised and lowered for a custom fit. The mounting clamp firmly grips the engine guard and the locking design secures the peg at the desired angle. Available in mirror-chrome or gloss black finishes, the complete kit includes matching mounting hardware. Footpegs sold separately.

Fits 1.25" engine guards.

<b>50829-07A</b>	5.0" Long Angled – Chrome.	<b>\$119.95</b>
<b>50830-07A</b>	2.5" Short Angled – Chrome.	<b>\$119.95</b>
<b>50500167</b>	5.0" Long Angled – Gloss Black.	<b>\$119.95</b>
<b>50500168</b>	2.5" Short Angled – Gloss Black.	<b>\$119.95</b>



**\*WARNING:** Do not use engine guard footpegs under normal stop and go operating conditions. Doing so could result in death or serious injury.



**\*WARNING:** Do not use highway pegs under normal stop and go operating conditions. Doing so could result in death or serious injury.

#### Model Family Fitment:

V-ROD	SPORTSTER	DYNA
SOFTAIL	TOURING	

*Notice: The prices appearing in this catalog are the manufacturer's suggested retail prices. Actual retail prices may vary.*



# 602 CONTROLS

## Highway Pegs

### A. ADJUSTABLE HIGHWAY PEG MOUNTING KIT – OFFSET\*

Take rider comfort to the next level. These Offset Adjustable Highway Peg Mounts allow the rider a wide range of adjustment to accommodate nearly every shape and size. The offset design allows installation on the side or top of the engine guard and the 360° rotation permits comfortable positioning for short or tall riders. The clamp securely grips the engine guard and the locking design keeps the peg at the desired angle. Kit includes chrome-plated clamp, adjustable arm and chrome mounting hardware. Footpegs are sold separately.

Fits 1.25" engine guards.

<b>50827-07A</b>	4.5" Long Offset	<b>\$139.95</b>
<b>50828-07A</b>	3.0" Short Offset.	<b>\$139.95</b>

### B. ADJUSTABLE HIGHWAY PEG MOUNTING KIT – 360°\*

Change your foot position for added comfort on long stretches of open road. The 360° Adjustable Highway Peg can be rotated and locked in a wide range of positions to accommodate both the tall and short rider. The chrome-plated clamp holds its place on the engine guard and the arm locks the peg securely in position. Kit includes chrome-plated mount, arm and installation hardware. Footpegs sold separately.

<b>50832-07A</b>	3.0" Short Offset.	<b>\$119.95</b>
------------------	--------------------	-----------------

Fits 1.25" engine guards.

### C. FOOTPEG THREE-PIECE CHROME CLAMPS\*

For use on frame or engine guard. Universal mount except VRSC™ models.

<b>50903-85T</b>	<b>\$14.95</b>
------------------	----------------

Fits 1.25" engine guards (except VRSC Engine Guard P/N 49267-01A, 49388-09, XL Engine Guard P/N 49060-04 or Softail® Nostalgic Engine Guard P/N 49037-05A).

### D. ENGINE GUARD FOOTPEG MOUNTING KIT\*

Allows easy installation of any H-D® male mount-style footpegs on to H-D® front engine guards. All pieces necessary are included in the kit, with no extra hardware to buy.

<b>50964-98</b>	<b>\$44.95</b>
-----------------	----------------

Fits 1.25" engine guards (except VRSC Guard P/N 49267-01A, 49388-09, XL Engine Guard P/N 49060-04 or Softail Nostalgic Engine Guard P/N 49037-05A).

### E. ENGINE GUARD FOOTPEG MOUNT CHROME HARDWARE KIT\*

Jump from zinc to chrome with this chrome-plated hardware kit, which replaces the standard hardware in Engine Guard Footpeg Mounting Kit P/N 50964-98. Made to Original Equipment standards for unmatched quality, the bolts bear the "Harley-Davidson" mark to signify they're the genuine article.

<b>94140-02</b>	<b>\$19.95</b>
-----------------	----------------

Fits Engine Guard Footpeg Mounting Kit P/N 50964-98.



A. ADJUSTABLE HIGHWAY PEG MOUNTING KIT – LONG OFFSET



A. ADJUSTABLE HIGHWAY PEG MOUNTING KIT – SHORT OFFSET



B. ADJUSTABLE HIGHWAY PEG MOUNTING KIT – 360°



C. FOOTPEG THREE-PIECE CHROME CLAMPS



D. ENGINE GUARD FOOTPEG MOUNTING KIT



E. ENGINE GUARD FOOTPEG MOUNT CHROME HARDWARE KIT



**\*WARNING:** Do not use engine guard footpegs under normal stop and go operating conditions. Doing so could result in death or serious injury.



**\*WARNING:** Do not use highway pegs under normal stop and go operating conditions. Doing so could result in death or serious injury.

*Notice: The prices appearing in this catalog are the manufacturer's suggested retail prices. Actual retail prices may vary.*

# CONTROLS 603

## Footpegs



**F. ENGINE GUARD MOUNT FOOTPEGS – HARLEY SCRIPTED**



**F. ENGINE GUARD MOUNT FOOTPEGS – RUBBER INSERTS**



**G. BULLET TIP FOOTPEG BOLT KIT – CHROME**



**H. FOOTPEG MOUNTING HARDWARE KIT – CHROME**

Polished and chrome-plated hex head bolts replace the Original Equipment footpeg mounting hardware for a truly finished look. Kit includes two chrome-plated bolts and lock nuts with nylon inserts. The bolts carry a Harley-Davidson® Bar & Shield proof mark. All hardware is developed to Original Equipment standards to ensure product quality.

**94133-01** Harley Scripted. **\$39.95**  
**49144-86** Rubber Inserts. **\$39.95**

**I. FOOTPEG MOUNTING PINS – POLISHED**

Stainless steel for rust and corrosion resistance. Polished for good looks. Replaces Original Equipment footpeg mounting hardware.

**42679-01** **\$12.95**  
 Fits male mount-style footpegs (except '08-'13 XR and FLSTSE/2/3 models).

**J. ADJUSTABLE PASSENGER FOOTPEG MOUNT KIT**

Maximize your passenger's riding comfort. Proper foot position reduces the cramped or stretched-out feeling and relieves pressure on the knees and the tailbone. These Adjustable Mounts raise and lower the passenger footpeg to accommodate taller and shorter passengers. Easy to adjust with common tools, the mount adjusts through a 360° range (depending on model), allowing both fore and aft and up and down height adjustment. Kit includes left and right adjustable support assembly and all required mounting hardware. Footpegs sold separately.

**50763-09** **\$149.95**  
 Fits models with H-D® male mount-style passenger footpeg supports (except Softail®). Does not fit with Heel Raiser Footpeg Kit P/N 50178-09. Does not fit the rider position.



**H. FOOTPEG MOUNTING HARDWARE KIT – CHROME**



**I. FOOTPEG MOUNTING PINS – POLISHED**



**J. ADJUSTABLE PASSENGER FOOTPEG MOUNT KIT**



**\*WARNING:** Do not use engine guard footpegs under normal stop and go operating conditions. Doing so could result in death or serious injury.

**Model Family Fitment:**

- V-ROD
- SPORTSTER
- DYNA
- SOFTAIL
- TOURING

*Notice: The prices appearing in this catalog are the manufacturer's suggested retail prices. Actual retail prices may vary.*



# 604 CONTROLS

## Mirrors

### A. FAIRING MOUNT MIRRORS – BLACK

Fairing Mount Mirrors offer a truly innovative look from the traditional handlebar-mounted mirrors. Mounting just inside the inner fairing, the molded plastic mirror housings complement the contours of the batwing fairing. They provide a wide range of adjustability and feature convex mirror glass that maximizes your field of view. The Bar & Shield logo is carefully laser-etched on each mirror glass. Kit includes necessary hardware, instructions and mounting template for easy installation.

**56000076** **\$99.95**

Fits '14-later Electra Glide® and Tri Glide® models. Original Equipment on Street Glide® models.

**91945-98B** **\$99.95**

Fits '96-'13 Electra Glide and Trike models. Original equipment on Street Glide models.



A. FAIRING MOUNT MIRRORS – BLACK

### B. FAIRING MOUNT MIRRORS – CHROME

Add a splash of chrome to the batwing inner fairing. These Fairing Mount Mirrors de-clutter the handlebar and add a contemporary aero style to your ride. The attractive chrome housing provides a custom look and the convex mirror and wide range of adjustment maximizes your field of view. A direct bolt-on replacement for Original Equipment fairing mount mirrors, the kit includes the hardware and mounting template required for easy and accurate installation.

**56000077** **\$134.95**

Fits '14-later Electra Glide, Street Glide and Tri Glide models.

**56000029** **\$134.95**

Fits '96-'13 Electra Glide, Street Glide and Trike models. Original Equipment on '12 FLHXSE models.



B. FAIRING MOUNT MIRRORS – CHROME

### C. SPLIT VISION FAIRING MOUNT MIRRORS

See even more of the world that you just passed. This exclusive-design Split Vision Mirror minimizes blind spots and provides a wide panoramic rear view of the left and right lane and the road behind you. The mirror features a large primary panel for normal view and a second outboard convex panel for a wider field of vision. Slightly larger than the standard-view Fairing Mount Mirrors, these Split Vision Mirrors offer the same full range of adjustability. A direct bolt-on replacement for standard-view Fairing Mount Mirrors, the kit also includes the hardware and mounting template required for easy and accurate installation.

**92085-10** **\$109.95**

Fits '96-'13 Electra Glide, Street Glide and Trike models (pair). Does not fit with Chrome Fairing Mount Mirror Covers P/N 91924-09, Illuminated Chrome Mirror Covers P/N 92600-10 or Fairing Mount Mirror Covers P/N 92200001.



C. SPLIT VISION FAIRING MOUNT MIRRORS

### D. FAIRING MOUNT MIRROR COVERS – CHROME

Add a splash of chrome to the inner fairing. The chrome-plated housings wrap around the back and side of the fairing mount mirrors, presenting a clean, uncluttered profile. The perfect finishing touch to a fully dressed inner fairing.

**91924-09** **\$74.95**

Fits '06-'13 FLHX, FLHXSE and FLHXXX models and other Electra Glide models equipped with Fairing Mount Mirrors P/N 91945-98B. Does not fit with Split Vision Fairing Mount Mirrors P/N 92085-10.



D. FAIRING MOUNT MIRROR COVERS – CHROME

\*Harley-Davidson Motor Company cannot test and make specific fitment recommendations concerning every possible mirror and handlebar combination. Therefore, after installing new mirrors or handlebars and before operating the motorcycle, check to ensure that the mirrors provide the operator a clear view to the rear.

Notice: The prices appearing in this catalog are the manufacturer's suggested retail prices. Actual retail prices may vary.

# CONTROLS 605

## Mirrors



**E. ILLUMINATED FAIRING MOUNT MIRROR COVERS – CHROME**



**E. ILLUMINATED FAIRING MOUNT MIRROR COVERS – CHROME**

Add auxiliary LED turn signals and a splash of chrome to the inner fairing. The perfect finishing touch to a fully dressed inner fairing, these chrome-plated mirror housings feature fast-acting amber LED turn signals at the outer edge. Side turn signals attract attention from the drivers around you and the plug-in, no-splice design simplifies installation.

**56000084** **\$134.95**

Fits '14-later Touring and Trike models with fairing-mount mirrors. Does not fit with Split Vision Fairing Mount Mirrors P/N 92085-10.

**92600-10** **\$134.95**

Fits '06-'13 FLHX, FLHXSE and FLHXXX models and other Electra Glide® models equipped with Fairing Mount Mirrors P/N 91945-98B. Does not fit with Split Vision Fairing Mount Mirrors P/N 92085-10.

**F. MIRRORS WITH AUXILIARY RUNNING LIGHT AND DIRECTIONAL INDICATOR\***

Function and style in one package. This forged mirror combines a traditional swept shape with a contemporary addition – forward-facing auxiliary lighting. Smoked lenses hide bands of amber LED lamps that glow as running lamps when the ignition is on and add a fast-acting auxiliary directional indicator when the turn signals are activated. The forward-facing eye-level lamps command additional attention from oncoming traffic. Both mirrors flash when the emergency hazard lights are activated. The wiring is concealed in the housing and stem and is easily connected to the Original Equipment wiring harness. Available in mirror-chrome or satin black finish.

Fits '14-later Touring (except Road King®) and Trike models.

**56000080** Chrome. **\$309.95**

**56000081** Black. **\$309.95**

Fits '97-later models (except VRSCF, XG, XL1200X, FXCWC and '14-later Touring). Also fits '14-later Road King models.

**92059-07A** Chrome. **\$299.95**

**92068-08A** Satin Black. **\$299.95**

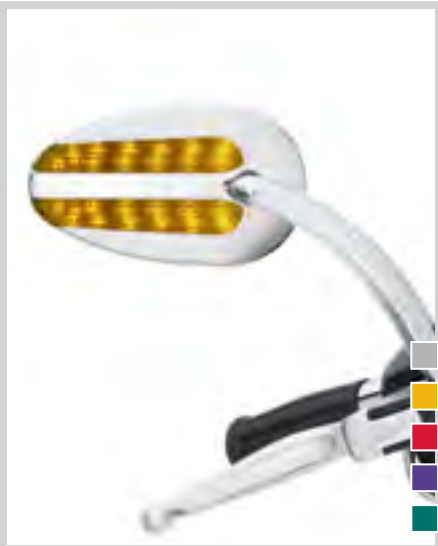

**F. MIRRORS WITH AUXILIARY RUNNING LIGHT AND DIRECTIONAL INDICATOR – CHROME**



**F. MIRRORS WITH AUXILIARY RUNNING LIGHT AND DIRECTIONAL INDICATOR – SATIN BLACK**



**Model Family Fitment:**

- V-ROD
- SPORTSTER
- DYNA
- SOFTAIL
- TOURING

*Notice: The prices appearing in this catalog are the manufacturer's suggested retail prices. Actual retail prices may vary.*



# 606 CONTROLS

## Mirrors

### A. PROFILE CUSTOM MIRRORS WITH SLOTTED STEM\*

Billet-style mirror features a low-profile swept back design, slotted stem and a laser etched "Harley-Davidson" script on mirror back. The teardrop shape provides excellent rearward visibility and the slim lines add a true custom touch.

**91697-06A** **\$139.95**

Fits '82-later models (except VRSCF, '14-later FLHTKSE and XL1200X mounted below the handlebars).

### B. TRIBAL COLLECTION MIRRORS\*

Billet-style mirror features a tapered shape that provides excellent rearward visibility. The deeply grooved stem and the swept-back design hug the contour of the handlebar and the tribal flames add an element of ancient mystery. The distinctive cast-in recesses of the tribal layout highlight the details in the metal work and add depth and dimension to the gloss black or polished chrome finish. Design complements the available Tribal Collection hand grips, footpegs and foot controls.

Fits '82-later models (except VRSCF and XL1200X mounted below the handlebars).

**92410-09** Chrome. **\$129.95**

**92398-09** Gloss Black. **\$129.95**

### C. BUCKSHOT MIRRORS\*

The deep grooved and perforated stem of this custom mirror is the ideal complement to the Buckshot Collection of foot and hand controls. The tapered mirror and stem are polished and chrome-plated or black-coated for a deep luster.

Fits '82-later models (except VRSCF and XL1200X mounted below the handlebars).

**92096-05** Chrome. **\$219.95**

**92416-08** Satin Black. **\$219.95**

### D. BULLET MIRRORS\*

This sweeping teardrop-shaped mirror is manufactured from forged aluminum and beautifully chrome-plated for a custom appearance. The "bullet grooved" curved stem and the smooth mirror housing are highlighted with a laser-etched "Harley-Davidson" script.

**91657-02** **\$219.95**

Fits '82-later models (except VRSCF and XL1200X mounted below the handlebars).

### E. EDGE CUT MIRRORS\*

The slotted stem of this custom mirror is the ideal complement to the Edge Cut Collection of foot and hand controls. The tapered stems are black-anodized for a rich finish and the slots are machined to expose the raw aluminum and form the final cut back look. The satin black mirror shell complements the Original Equipment hand control finish for a cohesive look.

**92441-10** **\$219.95**

Fits '82-later models (except VRSCF and XL1200X mounted below the handlebars).



A. PROFILE CUSTOM MIRRORS WITH SLOTTED STEM



B. TRIBAL COLLECTION MIRRORS - CHROME



B. TRIBAL COLLECTION MIRRORS - GLOSS BLACK



C. BUCKSHOT MIRRORS - CHROME



C. BUCKSHOT MIRRORS - SATIN BLACK



D. BULLET MIRRORS



E. EDGE CUT MIRRORS

\*Harley-Davidson Motor Company cannot test and make specific fitment recommendations concerning every possible mirror and handlebar combination. Therefore, after installing new mirrors or handlebars and before operating the motorcycle, check to ensure that the mirrors provide the operator a clear view to the rear.

Notice: The prices appearing in this catalog are the manufacturer's suggested retail prices. Actual retail prices may vary.

# CONTROLS 607

## Mirrors



F. DOME BILLET STYLE MIRRORS

### F. DOME BILLET STYLE MIRRORS – SATIN BLACK\*

This special mirror features a smooth, dome-shaped billet head, unique single slot stem and a satin black mirror. It's a clean look that provides distinctive style.

**92423-08A** **\$199.95**  
Fits '65-later models (except VRSCF and XL1200X mounted below the handlebars).

### G. SPLIT VISION MIRRORS\*

See even more of the world you just passed. This exclusive-design Split Vision Mirror minimizes blind spots and provides a wide panoramic rear view of the left and right lane and the road behind you. The mirror features a large primary panel for normal view and a second outboard convex panel for a wider field of vision. Chrome-plated to a brilliant shine, the mirror's shape adds a contemporary touch to the traditional teardrop design. The deep embossed "Harley-Davidson" script and the curving slotted stem set this mirror apart from the others.

**92190-06** **\$129.95**  
Fits '82-later models (except VRSCF and XL1200X mounted below the handlebars).



G. SPLIT VISION MIRRORS

### H. SLIPSTREAM MIRRORS\*

The tapered shape and the rich finish of these Slipstream Mirrors set the stage for a show-winning look. The teardrop-shaped mirrors feature stylish aero-inspired spears deeply embedded in the surface and square-shouldered pads for a contemporary look. The rich chrome surfaces and contrasting raised black panels complement the complete Slipstream Collection and look right on both blacked-out and chrome-covered bikes.

**56000006** **\$129.95**  
Fits '82-later models (except VRSCF and XL1200X mounted below the handlebars).

### I. TAILFIN CUSTOM MIRRORS\*

This billet-style swept Tailfin Mirror offers a unique view of the road behind you. The finned mirror back and the custom raised-rib mirror stem combine to bring the art deco "streamliner" look into the 21st century. The die-cast mirror body and forged stem are polished and chrome-plated for a brilliant finish.

**91696-05A** **\$119.95**  
Fits '82-later models (except VRSCF, '14-later FLHTKSE, FLHRSE6, FLHR and FLHRC models and XL1200X mounted below the handlebars).



H. SLIPSTREAM MIRRORS

### J. WILLIE G SKULL TEARDROP MIRRORS\*

Add a little attitude to your ride. Styled to complement Harley-Davidson® Skull accessory items, the menacing raised skull with black-filled eyes leaps from a field of chrome. The surrounding "Harley-Davidson Motorcycles" script is the perfect finishing touch. The teardrop shape improves rearward visibility.

**91315-04** **\$119.95**  
Fits '82-later models (except VRSCF and XL1200X mounted below the handlebars).



I. TAILFIN CUSTOM MIRRORS

J. WILLIE G SKULL TEARDROP MIRRORS

\*Harley-Davidson Motor Company cannot test and make specific fitment recommendations concerning every possible mirror and handlebar combination. Therefore, after installing new mirrors or handlebars and before operating the motorcycle, check to ensure that the mirrors provide the operator a clear view to the rear.

#### Model Family Fitment:

V-ROD
  SPORTSTER
  DYNA
   
 SOFTAIL
  TOURING

Notice: The prices appearing in this catalog are the manufacturer's suggested retail prices. Actual retail prices may vary.



# 608 CONTROLS

## Mirrors

### A. TEARDROP MIRRORS\*

High-profile custom mirrors at a great price. These beautifully chrome-plated mirrors are available in two styles, Classic and Script. They feature laser-etched convex glass and black, color-filled graphics.

Fits '82-later models (except VRSCF and XL1200X mounted below the handlebars).

<b>91971-98</b>	Classic.	<b>\$99.95</b>
<b>91968-98</b>	"Harley-Davidson" Script.	<b>\$99.95</b>



A. TEARDROP MIRRORS – CLASSIC

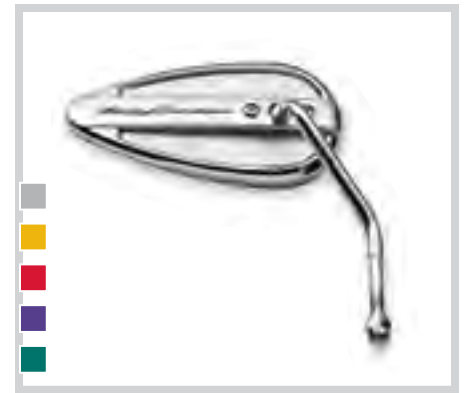

A. TEARDROP MIRRORS – "HARLEY-DAVIDSON" SCRIPT

### B. OVAL ALUMINATOR® BILLET STYLE MIRRORS\*

Some people would call this a collection that is precision-made by computer-controlled machinery which produces rare shapes, beveled edges, subtle counterbores and distinctive ovals. We call it the Aluminator® Collection. Signature Aluminator styling gets added function with a specially machined stem and convex lens that allow adjustments for the optimum field of view. Both the extruded aluminum stem and forged aluminum head are machined, polished and chrome-plated.

**91965-98** **\$199.95**  
Fits '82-later models (except VRSCF and XL1200X mounted below the handlebars).



B. OVAL ALUMINATOR BILLET STYLE MIRRORS

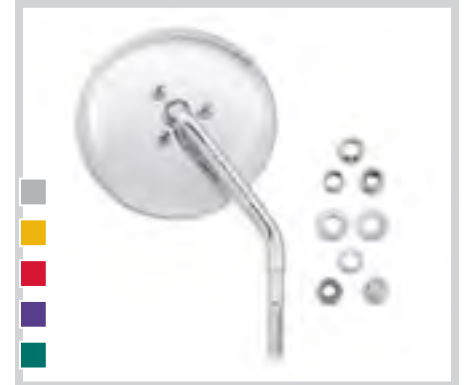

C. ONE-PIECE ROUND MIRRORS

### C. ONE-PIECE ROUND MIRRORS\*

Fits all models (except VRSCF and XL1200X mounted below the handlebars).

<b>91931-92T</b>	Short Stem, Left Side.	<b>\$24.95</b>
<b>91930-92T</b>	Short Stem, Right Side.	<b>\$24.95</b>

### D. "LIVE TO RIDE" LOGO COLLECTION MIRRORS\*

Fits '65-later models (except VRSCF and XL1200X mounted below the handlebars).

#### 1. One-Piece Short Stem Mirrors

<b>91866-90T</b>	Gold, Left.	<b>\$43.95</b>
<b>91864-90T</b>	Gold, Right.	<b>\$43.95</b>

#### 2. One-Piece Long Stem Mirrors

<b>91871-93T</b>	Gold, Left.	<b>\$45.95</b>
<b>91861-93T</b>	Gold, Right.	<b>\$45.95</b>

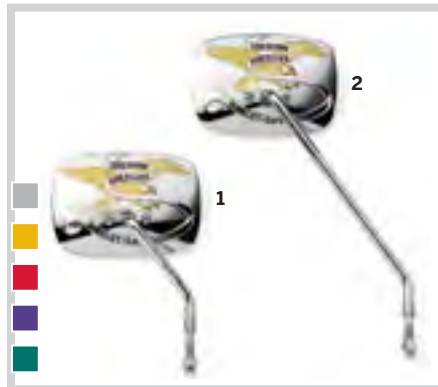

D. "LIVE TO RIDE" LOGO COLLECTION MIRRORS – GOLD



E. FLAMES COLLECTION MIRRORS

### E. FLAMES COLLECTION MIRRORS\*

Fits '65-later models (except VRSCF and XL1200X mounted below the handlebars).

<b>91940-98</b>	Short Stem, Left.	<b>\$43.95</b>
<b>91939-98</b>	Short Stem, Right.	<b>\$43.95</b>

### F. LONG STEM ONE-PIECE MIRRORS – BLACK\*

Fits '65-later models (except VRSCF and XL1200X).

<b>91910-90A</b>	Long Stem, Left.	<b>\$28.95</b>
<b>91909-90A</b>	Long Stem, Right.	<b>\$28.95</b>



F. LONG-STEM ONE-PIECE MIRRORS – BLACK



G. TWO-PIECE MIRRORS – CHROME

### G. TWO-PIECE MIRRORS – CHROME\*

Fits '65-later models (except VRSCF and XL1200X).

<b>91875-70B</b>	Short Stem, Right or Left.	<b>\$28.95</b>
<b>91879-67B</b>	Long Stem, Right or Left.	<b>\$28.95</b>

\*Harley-Davidson Motor Company cannot test and make specific fitment recommendations concerning every possible mirror and handlebar combination. Therefore, after installing new mirrors or handlebars and before operating the motorcycle, check to ensure that the mirrors provide the operator a clear view to the rear.

Notice: The prices appearing in this catalog are the manufacturer's suggested retail prices. Actual retail prices may vary.

# CONTROLS 609

## Mirrors



H. TAPERED MIRRORS – BLACK



H. TAPERED MIRRORS – CHROME



I. MIRROR EXTENSION KIT – CHROME



I. MIRROR EXTENSION KIT – SATIN BLACK



J. MIRROR EXTENSION KIT

### H. TAPERED MIRRORS\*

Update your Harley® motorcycle with the latest style in mirrors. This 2003-later Original Equipment style tapered mirror provides improved rearward visibility, offers a wider range of adjustment and eliminates the rear fasteners for a cleaner look. Available in your choice of satin black or chrome finish.

Fits '65-later models (except VRSCF and XL1200X mounted below the handlebars).

<b>92023-03A</b>	Black – Short Stem Kit.	<b>\$69.95</b>
<b>91982-03B</b>	Black – Short Stem, Right.	<b>\$34.95</b>
<b>91983-03B</b>	Black – Short Stem, Left.	<b>\$34.95</b>
<b>91909-03B</b>	Black – Long Stem, Right.	<b>\$34.95</b>
<b>91910-03B</b>	Black – Long Stem, Left.	<b>\$34.95</b>
<b>92022-03A</b>	Chrome – Short Stem Kit.	<b>\$78.95</b>
<b>91840-03B</b>	Chrome – Short Stem, Right.	<b>\$39.95</b>
<b>91845-03B</b>	Chrome – Short Stem, Left.	<b>\$39.95</b>
<b>91846-03B</b>	Chrome – Long Stem, Right.	<b>\$39.95</b>
<b>91848-03B</b>	Chrome – Long Stem, Left.	<b>\$39.95</b>

### I. MIRROR EXTENSION KIT

See what's behind you. The Mirror Extension Kit improves visibility to the rear of your bike by repositioning mirrors outward approximately 2.0" and upward 1.0", clearing your field of view and allowing you to see past your shoulders. Available in your choice of chrome or satin black finish to match your mirrors and hand controls. Easy to install extenders fit a wide selection of Harley-Davidson® Original Equipment and accessory mirrors.

Fits '06-later Dyna® and '08-later Softail® models.

<b>56000039</b>	Chrome.	<b>\$54.95</b>
<b>56000042</b>	Satin Black.	<b>\$54.95</b>

### J. MIRROR EXTENSION KIT\*

Chrome-plated extenders relocate mirrors approximately two inches higher.

**91907-87** **\$29.95**

Fits all models (except VRSCF and XL1200X mounted below the handlebars).

\*Harley-Davidson Motor Company cannot test and make specific fitment recommendations concerning every possible mirror and handlebar combination. Therefore, after installing new mirrors or handlebars and before operating the motorcycle, check to ensure that the mirrors provide the operator a clear view to the rear.

#### Model Family Fitment:

 V-ROD	 SPORTSTER	 DYNA
 SOFTAIL	 TOURING	

Notice: The prices appearing in this catalog are the manufacturer's suggested retail prices. Actual retail prices may vary.



# 610 CONTROLS

## Hand Controls

### CHROME HAND CONTROL COMPONENTS

The flash of chrome. It's the first thing that everyone sees. And the one thing that everyone remembers. Dressing your bike's hand controls in chrome is one of the first steps in building a complete custom ride. After all, the hand controls are the one visual and physical connection you have with your bike every minute you are in the saddle. Harley-Davidson® offers all the components you need to make the custom conversion.

A complete Chrome Hand Control makeover would include:

- Chrome Clutch Bracket and Master Cylinder Reservoir Kit
- Chrome Switch Housing Kit
- Chrome Switch Cap Kit
- Chrome Hand Control Levers
- Custom Hand Grips
- Custom Brake Lines and Control Cables



CHROME HAND CONTROL COMPONENTS

### A. CHROME CLUTCH BRACKET AND MASTER CYLINDER RESERVOIR KIT

Replace your stock painted aluminum controls with brilliant chrome, without compromising quality. This kit is manufactured from the Original Equipment components and includes Chrome Master Cylinder Cover. When combined with Chrome Switch Housing Kit, Chrome Switch Caps and other Harley-Davidson® Genuine Motor Accessories, this front brake control kit provides a look that does more than stop your bike – it can stop traffic.

**41700190** \$359.95  
Fits '14-later XL models with single disc front brake with ABS.

**41700262** \$359.95  
Fits '14-later XL models with single disc front without ABS.

**42307-07** \$359.95  
Fits '07-'13 XL models with single disc front brakes.

**42307-04** \$359.95  
Fits '04-'06 XL models with single disc front brakes.

**45284-99D** \$359.95  
Fits '96-'03 XL, '96-'05 Dyna® and Softail® models with single disc front brakes and cable operated clutch.

**45281-99D** \$359.95  
Fits '96-'03 XL, '96-'05 Dyna and Softail and '96-'04 Touring models with dual disc front brakes and cable operated clutch.

**45355-08** \$359.95  
Fits '08-later Dyna (except '14-later FXDL) and '08-'14 Softail models equipped with single disc front brakes and cable operated clutch.

**45355-06A** \$359.95  
Fits '06-'07 Dyna and Softail models equipped with single disc front brakes and cable operated clutch.

**42117-08** \$399.95  
Fits '08-later Touring models with cable operated clutch.

**46418-05A** \$359.95  
Fits '05-'07 Touring models with cable operated clutch.

**46112-02D** \$399.95  
Fits '02-'05 VRSC™ models. Also fits hydraulic clutch-equipped '96-'05 Dyna and Softail and '96-'04 Touring models with dual disc front brakes.

**42100-06A** \$639.95  
Fits '06-later VRSC models.

**41700263A** \$649.95  
Fit '14-later Touring (except Road Glide®) models with hydraulic clutch. Does not fit Trike models.

**36700100** \$399.95  
Fits '15-later Softail models with cable operated clutch.

**41700324** \$649.95  
Fits '15-later Road Glide models.



A. CHROME CLUTCH BRACKET AND MASTER CYLINDER KIT – (41700190 SHOWN)



A. CHROME CLUTCH BRACKET AND MASTER CYLINDER KIT – (42307-07 SHOWN)



A. CHROME CLUTCH BRACKET AND MASTER CYLINDER KIT – (45355-08 SHOWN)



A. CHROME CLUTCH BRACKET AND MASTER CYLINDER KIT – (42117-08 SHOWN)

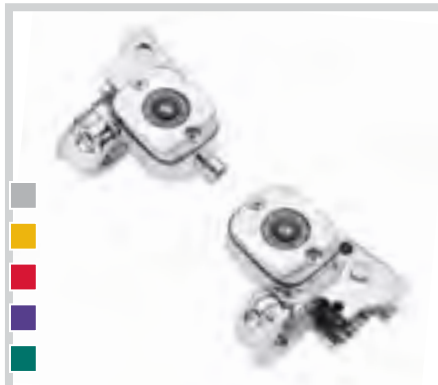

A. CHROME CLUTCH AND BRAKE MASTER CYLINDER KIT – (46112-02D SHOWN)



A. CHROME CLUTCH AND BRAKE MASTER CYLINDER KIT – (41700263 SHOWN)

Notice: The prices appearing in this catalog are the manufacturer's suggested retail prices. Actual retail prices may vary.



**B. SWITCH HOUSING KIT – CHROME**  
(71500185 SHOWN)



**B. SWITCH HOUSING KIT – CHROME**  
(70222-96B SHOWN)



**B. SWITCH HOUSING KIT – CHROME**  
(70223-96B SHOWN)



**C. HANDLEBAR RESERVOIR COVER SET**



**D. TURN SIGNAL EXTENSION CAPS – BLACK**



**D. TURN SIGNAL EXTENSION CAPS – CHROME**

### B. SWITCH HOUSING KIT – CHROME

Convert your handlebar switch housings from black to brilliant chrome. Complete kit includes left and right housings sets. No switches or wiring required.

**70222-96B** **\$139.95**  
Fits '96-later VRSC™, '96-'13 XL, '08-'12 XR and '96-'13 FLHR models. Also fits '96-'11 Dyna® and '96-'10 Softail® models. Does not fit FXSTDSE and FLHRSE models.

**71826-11** **\$99.95**  
Fits '14-later XL and '12-later Dyna and Softail models (except FLSTSE/2 and FXSBSE).

**70223-96B** **\$149.95**  
Fits '96-'13 FLHT, FLHTC and '06-'13 FLHX, FLHXXX and FLTRX models without cruise control.

**70228-96C** **\$149.95**  
Fits '96-'13 FLHTCU, FLHTCUTG, FLHTK, FLTR, FLTRU and '02-'13 FLHRC models. Also fits '02-'13 FLHR models equipped with cruise control.

**71813-09** **\$149.95**  
Fits '96-'13 FLHT, FLHTC, FLHX, FLHXXX and FLTRX models equipped with cruise control.

**71500185** **\$149.95**  
Fits '14-later Touring and Trike models.

### C. HANDLEBAR RESERVOIR COVER SET

This kit includes a chrome-plated clutch bracket, handlebar control clamps, master cylinder cover and hardware to completely finish chroming the hand controls. Combine with chrome-plated Switch Housing Kit P/N 70222-96B to finish the look. Cannot be used with Auxiliary Lighting Kits.

**46099-98** **\$79.95**  
Fits '96-'03 XL, '96-later Dyna, '96-'14 Softail and '96-'07 Touring models with dual disc front brakes. (Does not fit VRSC models or models equipped with hydraulic clutch.)

**46098-98** **\$79.95**  
Fits '96-'03 XL, '96-later Dyna and '96-'14 Softail models with single disc front brakes. (Does not fit models equipped with hydraulic clutch.)

### D. TURN SIGNAL EXTENSION CAPS

Make signaling simple. These Turn Signal Extension Caps allow riders to easily reach and activate turn signals without repositioning or removing their hands from the grips. The one-piece design features a contoured thumb extension that places the left and right hand signal control in a comfortable position. Available in chrome and black, these Extension Caps replace the stock turn signal switch caps without re-wiring.

Fits '14-later XL, '12-later Dyna and '11-later Softail models (except FLSTSE and FXSBSE).

**71500177** Black. **\$24.95**

**71500178** Chrome. **\$24.95**

Fits '96-later VRSC, '96-'13 XL, '08-'12 XR, '96-'13 Touring, '96-'11 Dyna and '96-'10 Softail models.

**71500179** Black. **\$24.95**

**71500180** Chrome. **\$24.95**

Fits '14-later Road King® and Freewheeler™ models.

**71500285** Black. **\$24.95**

Fits '14-later Electra Glide®, Street Glide® and Tri-Glide® models.

**71500286** Black. **\$24.95**

#### Model Family Fitment:

- V-ROD
- SPORTSTER
- DYNA
- SOFTAIL
- TOURING

*Notice: The prices appearing in this catalog are the manufacturer's suggested retail prices. Actual retail prices may vary.*



# 612 CONTROLS

## Hand Controls

### A. LIGHTED HAND CONTROL SWITCHES

Add function and style to the Original Equipment hand controls. Lighted Hand Controls feature soft white LED backlighting that illuminates the switch function icons for enhanced nighttime visibility. You get at-a-glance identification and a modern up-to-date look. Kit includes plug-in switch packs for left- and right-hand controls.

**71500248** **\$249.95**  
Fits '14-later Touring (except Road King®) and Trike models with hydraulic clutch. Stock on '14-later CVO™ Touring models.

**71500250** **\$249.95**  
Fits '14-later FLHR and FLHRC models with cable-actuated clutch.



A. LIGHTED HAND CONTROL SWITCHES

### B. SWITCH CAP KIT – CHROME

Not satisfied until everything you see is chrome? These Chrome Switch Cap Kits will add style to one of the most visible areas of your bike, the switches. Shaped for the same ergonomic feel as the Original Equipment hand control switches, these caps replace the stock black caps without re-wiring. The chrome switch caps complement other chrome hand control accessories (Chrome Master Cylinder Kit, Chrome Hand Levers, Chrome Switch Housings and Chrome Master Cylinder Cover) to complete the custom look.

**71804-03** **\$24.95**  
Fits '96-later VRSC™, '96-'13 XL, XR and FLHR models. Also fits '96-'11 Dyna, '96-'10 Softail® and '98-'01 FLHRC models. FLHR models equipped with cruise control use Kit P/N 71808-03.

**71500110** **\$26.95**  
Fits '14-later XL and '12-later Dyna and Softail (except FLSTSE3 and FXSBSE) models.

**71872-11** **\$26.95**  
Fits '11 Softail models (except FLSTSE2).

**71803-03** **\$26.95**  
Fits '96-'13 FLHT, FLHTC, FLHX, FLHXXX and FLTRX models without cruise control.

**71802-03** **\$26.95**  
Fits '96-'13 FLHTCU, FLHTCUTG, FLHTK, FLTR and FLTRU models.

**71808-03** **\$26.95**  
Fits '02-'13 FLHRC and FLHR models equipped with cruise control.

**71816-09** **\$26.95**  
Fits '96-'13 FLHT, FLHTC, FLHX, FLHXXX and FLTRX models with cruise control.

**71656-07** **\$14.95**  
Fits models equipped with Auxiliary On/Off Switch Kit P/N 71718-02.



A. LIGHTED HAND CONTROL SWITCHES – (71500248 SHOWN)



A. LIGHTED HAND CONTROL SWITCHES – (71500250 SHOWN)



B. SWITCH CAP KIT – CHROME (SHOWN WITH CHROME SWITCH HOUSING)

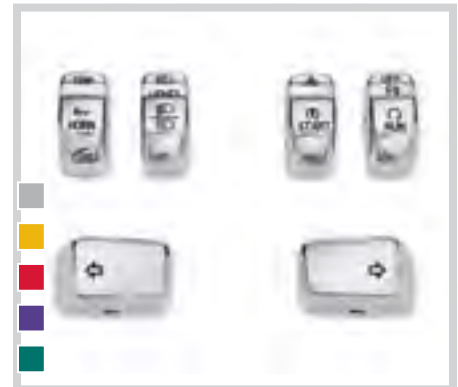

B. SWITCH CAP KIT – CHROME (71500110 SHOWN)

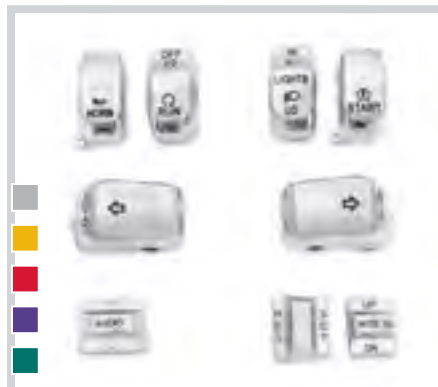

B. SWITCH CAP KIT – CHROME (71816-09 SHOWN)



B. SWITCH CAP KIT – CHROME (71656-07 SHOWN)

Notice: The prices appearing in this catalog are the manufacturer's suggested retail prices. Actual retail prices may vary.

# CONTROLS 613

## Hand Controls



**C. AUXILIARY ACCESSORY SWITCH HOUSING KIT – CHROME (SHOWN WITH AUXILIARY ON/OFF SWITCH)**



**C. AUXILIARY ACCESSORY SWITCH HOUSING KIT – BLACK (SHOWN WITH AUXILIARY ON/OFF SWITCH)**



**D. AUXILIARY ON/OFF SWITCH KIT**



**E. CHROME MASTER CYLINDER COVER '08-LATER TOURING MODELS**



**E. CHROME MASTER CYLINDER COVER 45078-96D**

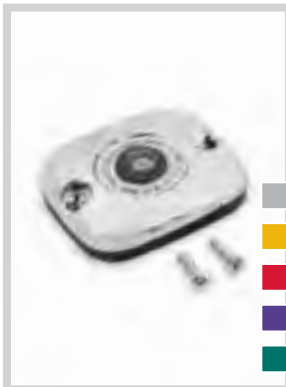

**E. CHROME MASTER CYLINDER COVER 46424-05B**



**E. CHROME MASTER CYLINDER COVER 42313-07**



**E. CHROME MASTER CYLINDER COVER 42123-08**



**E. CHROME MASTER CYLINDER COVER 36700094**



**E. CHROME MASTER CYLINDER COVER 42114-06A**

### C. AUXILIARY ACCESSORY SWITCH HOUSING KIT

Keep your eyes on the road and your hands on the grips with these easy-to-reach Auxiliary Accessory Switch Housings. Available for left and right hand control clusters, these housings will allow you to install up to six switches (when two housings are used) to control various electrical devices. Available in black to match Original Equipment switch housings or a bright chrome finish to complement accessory Chrome Switch Housing Kits. All necessary mounting hardware is included. Switches sold separately.

Fits '96-later VRSC™, XL, XR, Dyna®, Softail® and Touring models (except '15-later Road Glide® models). Does not fit Trike models. Does not fit models equipped with Large Diameter Handlebars, Handlebar-Mounted GPS, Boom!™ Audio Cruiser Amp & Speaker Kits or Tour-Pak® Mounted CD Changer P/N 77184-01. '04-later XL and XR models require separate purchase of (2) Screw P/N 3832M.

<b>70213-02C</b>	Chrome Left Side.	<b>\$36.95</b>
<b>70248-02B</b>	Black Left Side.	<b>\$36.95</b>

Fits '96-later VRSC, XL, XR, Dyna, Softail and Touring models (except '15-later Road Glide models). Does not fit Trike models. Does not fit models equipped with Large Diameter Handlebars, Handlebar-Mounted GPS, Boom! Audio Cruiser Amp & Speaker Kits or Tour-Pak Mounted CD Changer P/N 77184-01. '04-later XL and XR models require separate purchase of (2) Screw P/N 3832M.

<b>70255-02B</b>	Chrome Right Side.	<b>\$36.95</b>
------------------	--------------------	----------------

### D. AUXILIARY ON/OFF SWITCH KIT

Styled to match the Original Equipment hand controls. These Auxiliary On/Off switches allow you to control additional electrical accessories with the touch of a finger when installed in the Auxiliary Accessory Switch Housing. Switches sold individually.

<b>71718-02</b>		<b>\$15.95</b>
-----------------	--	----------------

Fits Auxiliary Accessory Switch Housing Kits P/N 70255-02B, 70256-02, 70213-02C and 70248-02B.

### E. FRONT MASTER CYLINDER COVER – CHROME

Includes chrome-plated cover, gasket and decal. Easily installed with included stainless steel screws.

<b>45078-96D</b>	Brake.	<b>\$39.95</b>
Fits '96-'03 XL, '02-'05 VRSC, '96-'05 Dyna and Softail and '96-'04 Touring models.		
<b>46424-05B</b>	Brake.	<b>\$39.95</b>
Fits '06-later Dyna, '06-'14 Softail and '05-'07 Touring models. Also fits '14-later Trike brake and clutch master cylinders.		
<b>42313-07</b>	Brake.	<b>\$39.95</b>
Fits '07-later XL and XR models.		
<b>42313-04</b>	Brake.	<b>\$39.95</b>
Fits '04-'06 XL models.		
<b>42123-08</b>	Brake.	<b>\$59.95</b>
Fits '08-later Touring and '09-'13 Trike models.		
<b>36700094</b>	Clutch.	<b>\$59.95</b>
Fits '14-later Touring models equipped with hydraulic clutch. Does not fit Trike models.		
<b>42114-06A</b>	Brake & Clutch (pair).	<b>\$129.95</b>
Fits '06-later VRSC models.		
<b>41700297</b>	Brake.	<b>\$49.95</b>
Fits '15-later Softail models.		

#### Model Family Fitment:

	V-ROD		SPORTSTER		DYNA
	SOFTAIL		TOURING		

Notice: The prices appearing in this catalog are the manufacturer's suggested retail prices. Actual retail prices may vary.



# 614 CONTROLS

## Hand Controls

### A. CHROME HAND CONTROL LEVER KIT

Continue the chrome theme with these Hand Control Levers. Cast from aluminum, these levers feature a custom finish designed to match the accessory chrome hand controls or complement Original Equipment-style black components. Clutch anti-rattle clip and new pivot bushing included.

**36700053A** Fits '14-later XL models. **\$139.95**

**36700065** **\$139.95**

Fits '14-later Touring models equipped with hydraulic clutch. Does not fit Trike models.

**36700091** **\$139.95**

Fits '14-later Trike models equipped with hydraulic clutch.

**38843-08** **\$139.95**

Fits '08-'13 Touring and Trike models. Also fits '14-later FLHR and FLHRC. Does not fit models equipped with hydraulic clutch.

**45075-07** **\$119.95**

Fits '96-'03 XL, '96-later Dyna®, '96-'14 Softail® and '96-'07 Touring models. Does not fit Police models or models equipped with hydraulic clutch.

**44992-07** Fits '04-'13 XL and XR models. **\$119.95**

**46114-07** **\$119.95**

Fits '02-'05 VRSC™ and '96-'06 Dyna, Softail and Touring models equipped with hydraulic clutch.

**42270-06B** Fits '06-later VRSC models. **\$159.95**

**36700104** **\$139.95**

Fits '15-later Softail models.

### B. BLACK HAND CONTROL LEVER KIT

Grab some black with these levers – a natural fit for black accessory handlebars or to further the blacked-out look of your motorcycle. A clutch anti-rattle clip and new pivot bushings are included.

**36700052** Fits '14-later XL models. **\$99.95**

**36700064** **\$139.95**

Fits '14-later Touring models equipped with hydraulic clutch. Does not fit Trike models.

**38845-08** **\$139.95**

Fits '08-'13 Touring and Trike models. Also fits '14-later FLHR and FLHRC. Does not fit models equipped with hydraulic clutch.

**44994-07** **\$99.95**

Fits '96-'03 XL, '96-later Dyna, '96-'14 Softail and '96-'07 Touring models. Does not fit Police models or models equipped with hydraulic clutch.

**46944-07A** Fits '04-'13 XL and XR models. **\$99.95**

**42275-07A** Fits '06-later VRSC models. **\$99.95**

**36700105** **\$139.95**

Fits '15-later Softail models.

### C. EDGE CUT HAND CONTROL LEVER KIT

Styled to complement the Edge Cut components, these slotted hand levers feature a cut back finish that looks great against black or chrome hand controls. The crisp black anodized finish is machined to expose the raw aluminum highlights.

**36700067** **\$159.95**

Fits '14-later Touring models equipped with hydraulic clutch. Does not fit Trike models.

**55798-10A** **\$139.95**

Fits '96-'03 XL, '96-later Dyna, '96-'14 Softail and '97-'07 Touring models. Does not fit Police models or models equipped with hydraulic clutch.

**36700004** **\$139.95**

Fits '08-'13 Touring and Trike models. Also fits '14-later FLHR and FLHRC. Does not fit models equipped with hydraulic clutch.

NEW



A. CHROME HAND CONTROL LEVERS

NEW



B. BLACK HAND CONTROL LEVERS



C. EDGE CUT HAND CONTROL LEVERS

*Notice: The prices appearing in this catalog are the manufacturer's suggested retail prices. Actual retail prices may vary.*

# CONTROLS 615

## Hand Controls



**D. SLOTTED HAND CONTROL LEVER KIT**

### D. SLOTTED HAND CONTROL LEVER KIT

Add that stripped-down custom look to your handlebar with these Slotted Chrome Hand Control Levers. Finished to a mirror-like shine, these billet-look levers place a touch of brilliance in the palm of your hand.

**36700066** **\$159.95**

Fits '14-later Touring models equipped with hydraulic clutch. Does not fit Trike models.

**38853-08** **\$159.95**

Fits '08-'13 Touring and Trike models. Also fits '14-later FLHR and FLHRC. Does not fit models equipped with hydraulic clutch.



**E. CLUTCH FERRULE AND BANJO BOLT COVER KITS**



**E. BRAKE & CABLE CLUTCH**



**E. BRAKE & HYDRAULIC CLUTCH**

### E. CLUTCH FERRULE AND BANJO BOLT COVER KITS

These chrome-plated die-cast covers provide a custom look to your hand controls. The pair of tapered covers conceals the brake banjo bolt cable and the clutch cable or hydraulic line connections as they enter the hand controls. The two-piece design is easy to install and adds a finishing touch to Original Equipment or braided lines and cables. Kits are available for models with cable- or hydraulic-operated clutch.

**41300061** Brake and Cable Clutch. **\$34.95**

Fits '84-later models (except VRSC™, '15-later XG, '08-later XR and '15-later Softail®). Will not fit models equipped with hydraulic clutch. Some models may require rotation of the front master cylinder banjo fitting. See the service manual for Brake systems procedures.

**41300062** Brake and Hydraulic Clutch. **\$34.95**

Fits '09-later VRSC and '08-later CVO™ models and bikes equipped with hydraulic clutch. Does not fit '15-later Softail models. Some models may require rotation of the front master cylinder banjo fitting. See the service manual for Brake systems procedures.

### F. CLUTCH FERRULE AND BANJO BOLT COVER KIT – CHROME

Die-cast chrome covers provide a custom look to your stock banjo bolts and handlebar clutch ferrule. Fits clutch ferrule on handlebar and banjo bolts on brake master cylinders and callipers. Installs in seconds.

**32714-98A** **\$34.95**

Fits '84-later models with stock master cylinder and callipers (except '02-later VRSC, '15-later XG, '04-later XL, '15-later Softail and '08-later Touring and Trike). Will not fit models equipped with hydraulic clutch.

### G. BANJO BOLT KIT – CHROME

Replace the Original Equipment 12-point zinc finish brake line hardware with brilliant chrome custom tapered banjo bolts.

**41842-06** **\$29.95**

Fits '91-'03 XL, '91-later Dyna (except FXDF), '95-'14 Softail and '99-'00 FXR models equipped with single disc front brake. Does not fit on the Dyna or Softail ABS Hydraulic Control Unit or with Banjo Bolt Cover Kit P/N 32715-98. Kit includes one 7/16" banjo bolt, three 3/8" banjo bolts and eight sealing washers.

**41844-06** **\$29.95**

Fits '02-'05 VRSCA and VRSCB and '93-'07 Touring models. Does not fit with Banjo Bolt Cover P/N 32715-98. Kit includes three 3/8" banjo bolts and six sealing washers.

### H. BANJO BOLT KIT – CHROME

Replace the Original Equipment zinc finish brake line hardware with brilliant chrome custom banjo bolts.

**41843-08** **\$49.95**

Fits '06-later VRSC, '08-later Touring and '09-'13 Trike models.



**F. CLUTCH FERRULE AND BANJO BOLT COVER KIT – CHROME**



**H. BANJO BOLT KIT – CHROME**



**G. BANJO BOLT KIT – CHROME**



#### Model Family Fitment:

- V-ROD
- SPORTSTER
- DYNA
- SOFTAIL
- TOURING

*Notice: The prices appearing in this catalog are the manufacturer's suggested retail prices. Actual retail prices may vary.*



# 616 CONTROLS

## Hand Controls

### A. REAR MASTER CYLINDER COVER – CHROME

An easy way to add chrome to your bike is with this chrome-plated version of the stock master cylinder cover.

**46463-08** **\$59.95**

Fits '08-later Touring models. Does not fit Trike models.

**46425-05A** **\$39.95**

Fits '06-later Dyna® without ABS, '06-later Softail® and '05-'07 Touring models.

**45149-99C** **\$39.95**

Fit '00-'05 Softail and '99-'04 Touring models.



A. REAR MASTER CYLINDER COVER – CHROME ('08-LATER MODELS SHOWN)

### B. SWITCH HOUSING HARDWARE KIT

Complete the chrome conversion with this Chrome Hardware Kit. Chrome-plated stainless steel hardware replaces the Original Equipment black hardware on the hand control switch housing, clutch and brake bracket clamps.

**91124-03A** **\$19.95**

Fits '96-later models (except 15-later XG, '04-later XL and XR and '15-later Softail, Touring and Trike).

### C. REDUCED EFFORT CLUTCH KIT

Kit includes a new clutch spring and inner/outer ramps that significantly reduce clutch lever effort. Original Equipment on '06-later Twin Cam-equipped models.

**36808-05** **\$49.95**

Fits '99-'05 Twin Cam-equipped models. Stock on '06-later Twin Cam-equipped models. This kit is not for use with Screamin' Eagle® Performance Parts.



A. REAR MASTER CYLINDER COVER – CHROME ('99-'07 MODELS SHOWN)

### D. CRUISE CONTROL KIT

For long-distance runs, there's nothing better than letting your bike do all the work. This Cruise Control Kit puts you closer to true touring bliss. The kit includes updated switch housing with controls that allow you to adjust your speed up or down with a flick of your thumb. The controls can be installed without splicing into the wiring harness or taking off the tank. Dealer must enable the cruise control function in the Electronic Control Module (ECM). Dealer installation is required.

**77196-08** **\$249.95**

Fits '08-'13 FLHX, FLHT, FLHTC, FLHXXX and FLTRX models.

**77197-08** Fits '08-'13 FLHR models. **\$249.95**

### E. HANDLEBAR SWITCH CONTROL KIT

Updated for use with '07-later models equipped with clutch interlock system. This exclusive Harley-Davidson® kit simplifies the switch to custom style handlebars. Kit features the Original Equipment left and right switch housings, 60.0" wiring harness and all necessary hardware.

**70239-07** **\$159.95**

Fits '96-'13 XL, XR, '96-'11 Dyna and '96-'10 Softail models (except '07-'10 FLSTF). Also fits '96-'13 Touring models without cruise control or radio controls.



B. SWITCH HOUSING HARDWARE KIT

C. REDUCED EFFORT CLUTCH KIT

#### Model Family Fitment:

- V-ROD
- SPORTSTER
- DYNA
- SOFTAIL
- TOURING



D. CRUISE CONTROL KIT – '08-LATER MODELS

E. HANDLEBAR SWITCH CONTROL KIT

*Notice: The prices appearing in this catalog are the manufacturer's suggested retail prices. Actual retail prices may vary.*

# CUSTOM BRAIDED CONTROL CABLES

Dress your bike for maximum impact. Harley-Davidson® offers a selection of braided cable and brake line finishes to complement your customizing style. All cables and brake lines feature a clear anti-yellowing outer jacket that provides superior scuff protection and easy maintenance. Available in stock and plus lengths for custom applications.

## CONTROL CABLES & BRAKE LINES



### DIAMONDBACK™ BRAIDED CONTROL CABLES & BRAKE LINES

Diamondback™ braided cables and lines feature a brilliant metallic finish that blends perfectly with chrome handlebars and controls or provides a stark contrast to "blacked-out" options. Fittings are finished in mirror chrome.



### DIAMOND-BLACK BRAIDED CONTROL CABLES & BRAKE LINES

Diamond-Black braided cables and lines utilize a black braided wire to provide a deeper, truer, black braided finish you can see from a distance. Fittings are matched in black chrome to provide a sinister look for your ride.

## SELECTING CABLES & BRAKE LINES

### CLUTCH CABLE FEATURES



### THROTTLE/IDLE CABLE FEATURES



### BRAKE LINE FEATURES

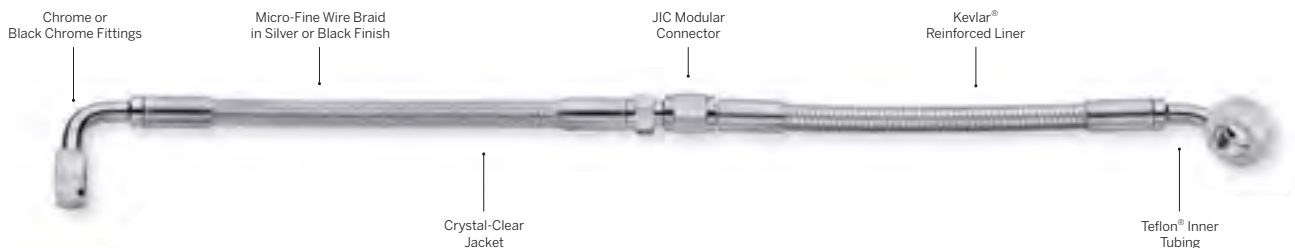



# 618 CONTROLS

## Control Cable Accessories

### A. BILLET CLUTCH CABLE ADJUSTER DUST COVER

Replace the black rubber clutch cable boot with brilliant chrome. Machined from billet aluminum, this two-piece "ball-milled" Dust Cover offers a striking contrast to Original Equipment black cables and a natural finishing touch when installing a braided clutch cable. Easy to install with included hardware.

**64108-03** Chrome. **\$49.95**  
 Fits '00-later XL, Dyna® and Softail® models (except FXS, FXSBSE, FLSTNSE and FLSTSE/2/3). '00-'03 XL models require installation of Clutch Cable Clamp P/N 91147-02 and '04-later XL models require installation of Clutch Cable Clamp P/N 91249-04 (sold separately).



**A. BILLET CLUTCH CABLE ADJUSTER DUST COVER**



**B. CLUTCH CABLE CLIP – CHROME (ROAD KING SHOWN)**

### B. CLUTCH CABLE CLIP

It's all in the details. This stylish clamp replaces the plastic clutch cable clip on the frame tube and locks the cable in place for a custom look. This kit includes the cable clip and chrome hardware for easy installation.

Fits '94-later Road King® models (except FLHRS).  
**38792-05A** Chrome. **\$34.95**

Fits '00-later Softail models (except FXCW, FXCWC, FXS, FXSB and FXSTSSE3).

**91360-03** Chrome. **\$34.95**  
**10800037** Edge Cut. **\$34.95**



**B. CLUTCH CABLE CLIP – CHROME (SOFTAIL SHOWN)**



**C. BILLET CLUTCH CABLE CLAMP – EDGE CUT (SOFTAIL SHOWN)**

### C. BILLET CLUTCH CABLE CLAMP – EDGE CUT

The perfect addition to braided or stock black clutch cables. The clamp is designed to grip the cable and the frame down tube, adding a custom look to the front of your cycle. This Clutch Cable Clamp is machined from aluminum billet and polished and finished for a lasting shine.

Fits '11-'14 Softail models with 1.25" diameter front frame downtube (except Softail models with hydraulic clutch).

**91147-02** Chrome. **\$44.95**  
**10800034** Edge Cut. **\$44.95**

Fits XL and Touring models with 1.375" diameter front frame downtube (except Touring models with hydraulic clutch or '14-later XL models with ABS).

**91249-04** Chrome. **\$44.95**  
**10800035** Edge Cut. **\$44.95**

Fits '06-later Dyna models with 1.5" diameter front frame down tube.

**38804-07** Chrome. **\$44.95**  
**10800036** Edge Cut. **\$44.95**

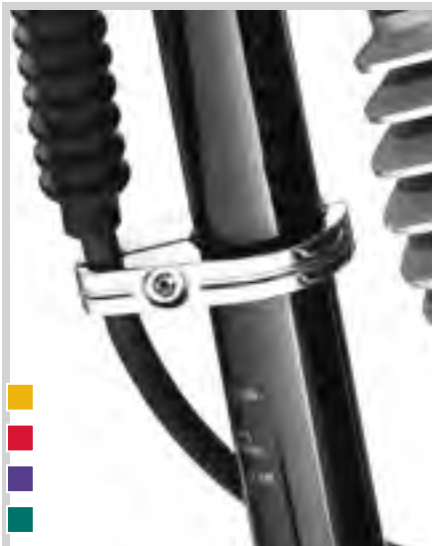

**C. BILLET CLUTCH CABLE CLAMP – CHROME**

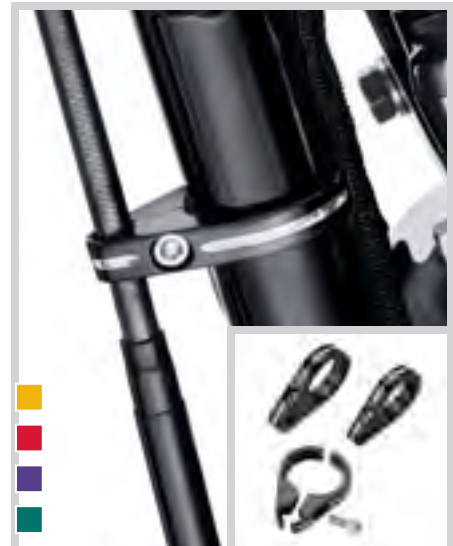

**C. BILLET CLUTCH CABLE CLAMP – EDGE CUT**

*Notice: The prices appearing in this catalog are the manufacturer's suggested retail prices. Actual retail prices may vary.*



**D. BILLET BRAKE LINE CLIP – CHROME**



**D. BILLET BRAKE LINE CLIP – EDGE CUT**

**D. BILLET BRAKE LINE CLIP**

It's the details that count. Replace the Original Equipment black brake line clamp with this beautifully finished billet aluminum clip. These "ball-milled" clips mount in the factory position for easy installation. Kit includes chrome-plated mounting hardware.

Fits '00-later XL and Dyna® (except FXDWG) models equipped with braided brake lines. Also fits '08-later Dyna models (except FXDWG) with Original Equipment brake lines.

<b>91369-03</b>	Chrome.	<b>\$29.95</b>
<b>10800038</b>	Edge Cut.	<b>\$29.95</b>

Fits '00-later FXST, FXSTB, FXSTC, FXSTD and FXDWG models equipped with braided brake lines. Also fits '08-later FXST, FXSTB, FXSTC and FXDWG with Original Equipment brake lines.

<b>91364-03</b>	Chrome.	<b>\$29.95</b>
<b>10800039</b>	Edge Cut.	<b>\$29.95</b>

**E. THROTTLE CABLE CLIP**

Tie up the loose ends to complete your custom ride. When matched to Original Equipment black cables or available braided cables, these decorative clips link the throttle and idle cables for a clean custom look.

Fits '84-later models (except '15-later XG, '08-later Touring and Trike, FLSTNSE, FLSTSE2/3 and FXSBSE).

<b>91274-04</b>	Chrome.	<b>\$34.95</b>
<b>10800033</b>	Edge Cut.	<b>\$34.95</b>

**F. THROTTLE AND IDLE CABLE ADJUSTER DUST COVERS – CHROME**

Replace the black rubber throttle and idle cable boots with brilliant chrome. These two-piece "ball-milled" Dust Covers offer a striking contrast to Original Equipment black cables and a natural finishing touch when installing braided cables. Easy to install with included hardware.

**64115-04** Chrome. **\$59.95**

Fits '96-'07 Touring models (except FLHRS with Original Equipment handlebar) and '96-later FXSTB and FLSTC and '05-later FLSTN. Will fit '05-later Softail® models (except FLS, FLSTFB, FLSTNSE, FXS, FXSB and FXSBSE) equipped with a separate purchase of a Front Turn Signal Relocation Kit.



**E. THROTTLE CABLE CLIP – CHROME**



**E. THROTTLE CABLE CLIP – EDGE CUT**



**F. THROTTLE AND IDLE CABLE ADJUSTER DUST COVERS – CHROME**

**Model Family Fitment:**

V-ROD	SPORTSTER	DYNA
SOFTAIL	TOURING	

*Notice: The prices appearing in this catalog are the manufacturer's suggested retail prices. Actual retail prices may vary.*



# COMFORT, STYLE OR BOTH?

Every person is unique. Your overall height, arm reach, upper body length and riding style all dictate your relationship to the bike's controls. Add in the desire for a unique, custom look and your handlebar options multiply exponentially.\*

### CHOOSING YOUR HANDLEBAR

**RISE** is the vertical distance between a handlebar's tip and its base. Adding risers to bars that sit too low can help put hand grips into your sweet spot.

**PULL BACK** is the distance the handlebar tips come back toward the rider. Greater pull back can eliminate the long reach to the bar for a shorter rider.

**WIDTH** is measured from tip-to-tip. Make sure the bar isn't too wide so it pulls your hands off the grips when turning.

**KNURL CENTER** is the distance between the centerline of the bar's knurling. The measurement should match the riser dimension to maximize clamping pressure.

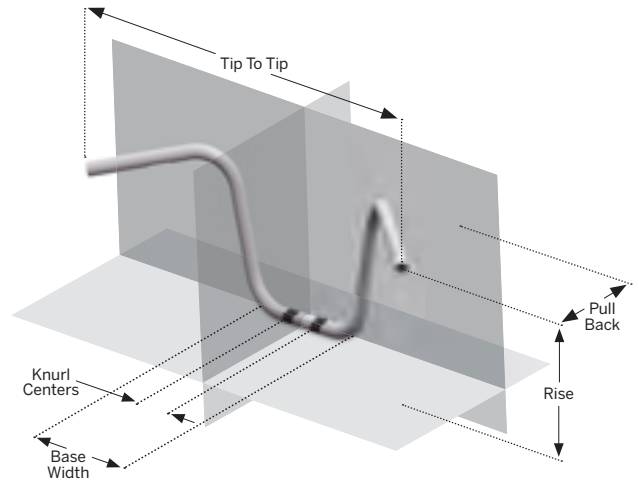

## YOUR RIDING POSITION



### DRAG HANDLEBAR

Narrow, flat and more aggressive, drag bars provide a straight elbow and neutral hand and wrist position. For maximum comfort, drag bars can be positioned with curved or straight risers to minimize stretch to the controls.



### APE HANGER & TALLBOY® HANDLEBAR

Tall and wide, ape hanger and Tallboy® handlebars provide a classic "fists-in-the-wind" look and can add long-haul comfort for riders with long arms. Because handlebar height is regulated in many areas, check local laws before installing a tall handlebar.

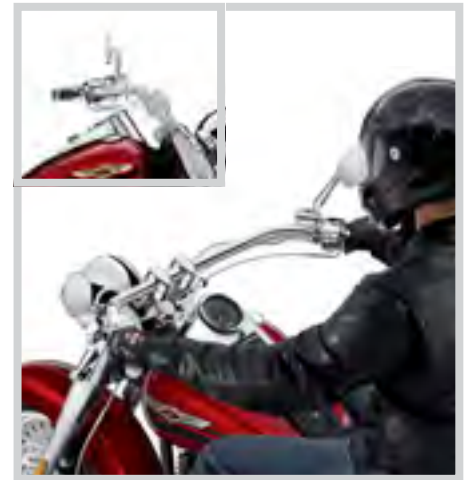

### BEACH HANDLEBAR

Low and wide, a beach bar spreads your arms and gives you room to breathe. Ideal for the rider with long arms, beach bars can be a little too wide for many riders. While selecting a bar, make sure you can reach the hand controls when the handlebar is fully turned.

## FIT SHOP TIPS



Your Dealer can help you with this simple experiment and recommend a handlebar that matches your ideal riding position. For more information, visit [h-d.com/fitshop](http://h-d.com/fitshop).

To get an idea how well your bike fits you, you can try this simple test. Block your bike so that it is level and stable, sit on the bike in your normal riding position and let your hands and arms hang down at your side. Now, close your eyes and reach out to where you think your ideal handlebar should be. With your hands grasping an imaginary handlebar, place them where they feel the best... that is, rotate your wrists to a natural position and spread your hands to a width that feels comfortable. Now open your eyes. This is where your bike's hand grips should be.

\*NOTE: Installation of some handlebars and risers may require a change in clutch and/or throttle cable and brake hose for some models. Handlebar height is regulated in many areas. Check local laws before installation.

**HANDLEBAR DIMENSIONS (IN INCHES)\***

Handlebar Kit	Bar Diameter	Width	Pull Back	Rise	Base Width	Knurl Width	Finish
55800027	1.00	30.50	4.62	5.25	7.50	3.00	Satin Black
55800032	1.00	28.50	6.80	9.87	5.50	-	Gloss Black
55800035	1.00	29.25	3.80	0.00	9.00	3.14	Satin Black
55800037	1.00	30.50	4.62	5.25	7.50	3.00	Polished SST
55800050	1.00	31.75	6.63	6.87	9.00	3.50	Gloss Black
55800058	1.25	32.00	7.00	7.75	11.25	3.50	Polished SST
55800082	0.88	30.30	1.75	6.30	7.00	3.35	Satin Black
55800094	1.25	33.75	7.25	9.75	10.00	3.22	Chrome
55800099	1.00	31.75	5.25	12.75	12.25	3.50	Polished SST
55800103	1.00	25.75	4.30	8.30	8.50	3.22	Satin Black
55800180	1.00	28.75	3.75	9.50	4.75	3.14	Polished SST
55800181	1.00	32.50	7.00	10.00	11.50	3.14	Polished SST
55800182	1.00	31.75	6.50	6.75	9.00	3.50	Polished SST
55800188	1.25	32.00	7.00	8.00	10.00	3.22	Chrome
55800198	1.00	25.75	4.30	8.30	8.50	3.22	Chrome
55800215	1.25	32.50	5.50	0.00	4.75	3.50	Gloss Black
55800224	0.88	30.00	1.90	8.25	8.40	3.23	Satin Black
55800233	1.00	30.50	5.66	4.75	7.75	3.50	Polished SST
55800237	0.88	30.00	1.90	8.25	8.40	3.23	Chrome
55800247	1.00	32.00	4.25	12.00	11.50	3.06	Polished SST
55800252	1.25	33.75	7.25	10.25	10.00	3.22	Chrome
55800305	1.00	30.50	7.25	12.00	15.00	3.38	Polished SST
55800332	1.25	32.25	10.50	9.50	12.50	3.14	Polished SST
55800379	1.25	32.25	10.50	9.50	12.50	3.14	Gloss Black
55800386	1.25	31.25	7.25	11.25	9.63	3.20	Chrome
55800388	1.25	31.25	7.25	11.25	9.63	3.20	Gloss Black
55840-04A	1.00	28.50	4.75	3.75	7.50	4.14	Polished SST
55845-04A	1.00	28.50	4.75	3.75	7.50	3.14	Polished SST
55857-10B	1.25	33.75	7.25	16.25	10.00	3.22	Satin Black
55859-10B	1.25	33.75	7.25	12.25	10.00	3.22	Satin Black
55861-09	1.00	30.25	6.25	9.75	15.75	3.50	Satin Black
55862-09	1.00	31.50	9.50	6.75	10.50	3.14	Satin Black
55864-09	1.00	31.25	5.00	12.00	11.50	3.14	Satin Black
55865-09	1.00	30.25	6.25	9.75	15.75	3.50	Satin Black
55898-07	1.00	29.00	3.75	0.00	10.50	3.14	Polished SST
55901-05	1.00	31.75	6.50	6.75	9.00	3.50	Polished SST
55908-04	1.00	30.50	11.00	8.00	13.50	3.14	Chrome
55914-98	1.00	30.75	7.50	12.25	15.00	3.50	Polished SST
55919-01	1.00	32.00	9.00	5.00	13.50	3.50	Polished SST
55919-82T	1.00	32.50	9.00	5.00	14.25	3.50	Chrome
55920-83B	1.00	29.75	5.75	9.50	13.25	3.50	Polished SST
55924-14	1.00	31.00	6.50	10.50	15.50	3.50	Polished SST
55924-08	1.00	30.25	6.25	9.75	15.75	3.50	Polished SST
55924-97	1.00	30.25	6.25	9.75	15.75	3.50	Polished SST
55933-97	1.00	30.00	9.25	5.50	12.00	4.75	Polished SST
55943-05	1.00	30.75	8.00	8.25	18.75	4.75	Polished SST
55947-00	1.00	31.00	9.00	5.50	12.50	3.14	Polished SST
55947-08	1.00	31.75	7.00	7.00	13.75	3.14	Polished SST
55954-00	1.00	30.00	9.00	9.50	13.75	3.14	Chrome
55967-08	1.25	35.50	4.75	11.50	12.25	3.50	Chrome
55975-08A	1.00	30.25	5.75	6.75	9.00	-	Chrome
55977-09	1.25	30.75	7.00	0.00	6.50	3.50	Satin Black
55980-10A	1.25	30.50	5.50	4.75	7.50	3.50	Polished SST
55985-10	1.00	30.25	5.75	6.75	9.00	-	Satin Black
55988-04	1.00	28.80	6.25	5.70	7.00	3.14	Polished SST
55997-06	1.00	29.00	2.50	1.50	6.50	3.50	Polished SST
56004-00	1.00	31.00	5.75	6.00	7.75	3.14	Polished SST
56012-09	-	31.75	4.12	6.00	-	-	Polished AL
56014-09A	1.00	28.50	4.75	3.75	7.50	3.14	Satin Black
56021-04B	1.00	31.00	5.75	6.00	8.75	4.25	Chrome
56029-00	1.00	28.00	6.25	10.00	8.00	3.50	Chrome

Handlebar Kit	Bar Diameter	Width	Pull Back	Rise	Base Width	Knurl Width	Finish
56032-08	1.25	31.50	7.50	9.75	9.00	3.25	Chrome
56036-08	1.00	31.75	6.50	10.00	15.75	3.50	Chrome
56038-05	1.00	27.50	8.25	4.25	9.50	3.14	Polished SST
56039-03A	1.00	30.00	8.00	12.50	3.50	-	Chrome
56046-01	1.00	29.50	7.50	17.00	8.25	-	Polished SST
56051-06	1.00	27.50	8.25	6.00	9.50	3.14	Polished SST
56075-07	1.00	32.00	6.50	8.75	10.00	3.14	Satin Black
56079-93	1.00	32.00	6.50	8.75	10.00	3.14	Polished SST
56079-93T	1.00	32.00	6.50	8.75	10.00	3.14	Chrome
56081-01	1.00	30.25	4.50	3.50	9.00	3.14	Polished SST
56081-82A	1.00	25.50	9.50	3.25	10.00	3.14	Polished SST
56082-83	1.00	26.75	4.75	4.00	6.50	3.14	Polished SST
56085-83A	1.00	31.00	5.75	6.00	7.75	3.14	Black SST
56085-83T	1.00	31.00	5.75	6.00	7.75	3.14	Chrome
56093-88A	1.00	25.50	9.75	3.75	12.00	4.75	Polished SST
56094-95	1.00	31.00	4.25	5.75	9.00	4.75	Polished SST
56102-99	1.00	30.00	9.25	5.25	11.75	3.14	Polished SST
56103-08A / 56273-08A	1.00	31.50	7.00	11.50	-	3.50	Polished SST
56110-98	1.00	26.75	4.75	4.00	6.50	3.14	Black SST
56152-04B	1.00	32.00	6.25	11.25	13.00	3.14	Chrome
56166-08	1.00	32.00	5.50	11.25	13.00	3.14	Chrome
56176-08	1.00	30.75	7.50	12.25	15.25	3.50	Polished SST
56180-08	1.00	30.00	9.00	9.50	13.75	3.14	Chrome
56184-08	1.00	34.00	5.00	9.75	17.00	3.50	Chrome
56185-98A	1.00	27.00	4.00	0.00	8.50	3.14	Polished SST
56188-00	1.00	31.00	4.25	5.75	9.00	3.50	Polished SST
56224-99A	1.00	27.00	3.75	0.00	10.00	3.14	Polished SST
56557-95	1.00	31.25	9.00	6.25	11.50	3.50	Chrome
56558-95	1.00	27.00	4.00	0.00	8.50	3.14	Chrome
56563-95	1.00	31.50	5.50	9.75	9.50	3.14	Chrome
56569-09	1.00	32.50	7.00	10.00	11.50	3.14	Polished SST
56569-86	1.00	31.25	5.00	12.00	11.50	3.14	Polished SST
56571-08	1.00	32.00	3.50	10.50	11.50	3.14	Polished SST
56571-98A	1.00	32.00	3.50	10.50	11.50	3.14	Polished SST
56623-99	1.00	31.25	5.00	12.00	11.50	3.14	Chrome
56760-04	1.25	35.50	4.75	12.00	12.25	4.75	Chrome
56787-05	1.25	32.60	7.00	8.50	9.00	3.50	Chrome
56832-04C	1.25	33.75	7.25	12.25	10.00	3.22	Chrome
56857-05	1.25	32.60	6.60	9.01	9.00	3.14	Chrome
56886-07A	1.25	31.50	9.00	5.25	13.50	3.90	Polished SST
56891-12	1.00	30.75	8.00	5.75	11.00	3.14	Polished SST
56902-08	1.00	31.25	5.00	12.00	11.50	3.14	Polished SST
56940-09	1.00	30.75	8.00	8.25	18.75	4.75	Gloss Black
56941-09	1.00	34.00	3.25	11.50	7.00	3.24	Chrome
56942-10B	1.25	33.75	7.25	16.25	10.00	3.22	Chrome
56947-08	1.00	28.00	5.25	9.00	-	3.50	Chrome
56951-09B	1.00	32.00	6.50	8.75	10.00	3.14	Polished SST
56953-07	1.00	30.50	3.25	3.50	7.00	3.50	Polished SST
56959-08A	1.25	30.75	7.00	0.00	6.50	3.50	Polished SST
56962-07	1.00	32.25	6.50	10.00	10.00	3.14	Polished SST
56964-07	1.00	34.00	5.00	9.75	17.00	3.50	Chrome
56977-08	1.00	32.50	7.00	10.00	11.50	4.75	Gloss Black
56981-07	1.00	30.50	3.25	3.50	7.00	3.50	Satin Black
57209-11	1.00	28.75	3.75	9.50	4.75	3.14	Polished SST
57466-10	1.00	28.80	6.25	5.70	7.00	3.14	Satin Black
57467-11 / 57469-11	1.00	27.38	3.50	7.68	5.50	-	Polished SST
57472-11	1.00	28.50	3.38	0.00	10.25	4.14	Polished SST
57474-11	1.00	35.00	1.75	12.00	16.00	3.50	Chrome
57485-11	1.00	35.00	1.75	12.00	16.00	3.50	Satin Black

\*NOTE: Installation of some handlebars and risers may require a change in clutch and/or throttle cable and brake lines for some models. Handlebar height is regulated in many areas. Check local laws before installation.



## 622 CONTROLS

### Handlebars

#### A. REDUCED REACH® HANDLEBAR\* – SPORTSTER®

This chrome handlebar is designed to bring the controls closer to the rider for increased comfort. Especially helpful for shorter riders or for riders that prefer a close-to-the-bar riding position.

**56021-04B** Chrome. **\$99.95**  
Fits '04-later XL883C and XL1200C models. Installation requires separate purchase of additional components.

*See your Dealer for cables, lines and additional installation components required, or visit [www.H-D.com/store](http://www.H-D.com/store) and search part number 56021-04.*

#### B. REDUCED REACH HANDLEBAR – FXSB SOFTAIL®

Shaped to provide the ideal balance of pull back and width, this chrome-plated bar places riders closer to the controls for a comfortable upright riding position. When combined with the Original Equipment Softail® Breakout® curved risers, the Reduced Reach Handlebar provides an overall pull back of 7.0". The 1.25" diameter handlebar can be internally wired for a clean look.

**55800188** Chrome. **\$279.95**  
Fits '13-later FXSB models. Separate purchase of additional components required.

*See your Dealer for cables, lines and additional installation components required, or visit [www.H-D.com/store](http://www.H-D.com/store) and search part number 55800188.*

#### C. REDUCED REACH HANDLEBAR\* – FXS BLACKLINE®

Designed with 4.0" of additional pull back, this two-piece handlebar is shaped to bring the controls closer to the rider. Not just for the short rider, this sleek bar adapts the riding position to put almost any size rider in an upright, relaxed riding profile. Finished in black, this 1.0" diameter handlebar can be internally wired for a clean look and is styled to match the aggressive stance of the Softail Blackline® motorcycle.

**55800032** Satin Black. **\$229.95**  
Fits '11-'13 FXS models. Separate purchase of additional components required.

*See your Dealer for cables, lines and additional installation components required, or visit [www.H-D.com/store](http://www.H-D.com/store) and search part number 55800032.*



A. REDUCED REACH HANDLEBAR – SPORTSTER



B. REDUCED REACH HANDLEBAR – FXSB SOFTAIL



C. REDUCED REACH HANDLEBAR – FXS BLACKLINE

\*NOTE: Installation of some handlebars and risers may require a change in clutch and/or throttle cable and brake lines for some models. Handlebar height is regulated in many areas. Check local laws before installation.

*Notice: The prices appearing in this catalog are the manufacturer's suggested retail prices. Actual retail prices may vary.*

# CONTROLS 623

Handlebars

CONTROLS

## D. EXTREME REDUCED REACH® HANDLEBAR

Extensively tested with a panel of riders between 5'-0" to 5'-5" tall, this Extreme Reduced Reach Handlebar and recommended riser combination was proven to be the most ergonomically pleasing handlebar for many Dyna® and Softail® models. Shaped to provide the ideal balance of pull back and width, this handlebar produces an overall pull back of 11.0" and a tip-to-tip width of 30.0" when combined with Curved Riser Kit P/N 56266-09 (sold separately). Your hands fall naturally in place and the narrow width reduces your stretch while making low-speed turns and parking lot maneuvers.

**56102-99**

**\$79.95**

Fits '06-later Dyna and '00-later Softail models (except FXCW, FXCWC, FXS, FXSB, FXSTD and Springer™). All models require separate purchase of additional installation components.

See your Dealer for cables, lines and additional installation components required, or visit [www.H-D.com/store](http://www.H-D.com/store) and search part number 56102-99.

## E. HERITAGE SOFTAIL® CLASSIC HANDLEBAR\*

Chrome-plated version of the stock bar. Replaces Original Equipment P/N 56569-86.

**56623-99**

Chrome.

**\$79.95**

Fits '86-later FLSTC models. '09-later models require separate purchase of cables and brake lines.

See your Dealer for cables, lines and additional installation components required, or visit [www.H-D.com/store](http://www.H-D.com/store) and search part number 56623-99.



D. EXTREME REDUCED REACH HANDLEBAR  
(SHOWN WITH CURVED RISER KIT)



E. HERITAGE SOFTAIL CLASSIC HANDLEBAR

\*NOTE: Installation of some handlebars and risers may require a change in clutch and/or throttle cable and brake lines for some models. Handlebar height is regulated in many areas. Check local laws before installation.

### Model Family Fitment:

■ V-ROD   ■ SPORTSTER   ■ DYNA  
■ SOFTAIL   ■ TOURING

Notice: The prices appearing in this catalog are the manufacturer's suggested retail prices. Actual retail prices may vary.



# 624 CONTROLS

## Handlebars

### A. BEACH HANDLEBAR\*

This beefy 1.25" bar shows off your bike in style! This fat bar allows you to tuck the wires inside the bar for a clean, custom appearance and the highly-polished and chrome-plated bar will get you noticed. Installation requires separate purchase of additional components.

**55967-08** Chrome. **\$204.95**

Fits '06-'07 and '13-later FXDB, '08-later FXDF, '01-'05 FXDL, '99-later FXDWG, '12-later FLD, '00-later FXST, FXSTB, FXSTC, FXSTD, FLS, FLSTC, FLSTF, FLSTFB, FLSTN and '03-'13 FLHR, FLHRC, FLHRS models. All models require separate purchase of additional installation components. Does not fit '08 ABS-equipped models, Heated Hand Grips, Hydraulic Clutch Kits, Handlebar Mounted Gauges, Road Tech™ Radio, Softail® Nacelle Kit P/N 67907-96C or Sidecar-equipped models.

*See your Dealer for cables, lines and additional installation components required, or visit [www.H-D.com/store](http://www.H-D.com/store) and search part number 55967-08.*

### B. NARROW BEACH HANDLEBAR\*

Original Equipment on the '07 Screamin' Eagle® Fat Boy® model, this beefy 1.25" handlebar sets the tone for a full-on custom ride. This chrome-plated fat bar combines the low rise and sweeping shape of a beach-style bar with a narrower tip-to-tip width for added rider comfort. Factory drilled to allow internal wiring for show-winning style.

**56857-05** Chrome. **\$204.95**

Fits '12-later FLD, '13-later FXDB, '00-later FXST, FXSTB, FXSTC, FXSTD, FLSTF, FLSTFB and FLSTC models. All models require separate purchase of Riser Kit P/N 56916-07 and additional installation components. Does not fit with Heated Hand Grips.

*See your Dealer for cables, lines and additional installation components required, or visit [www.H-D.com/store](http://www.H-D.com/store) and search part number 56857-05.*



A. BEACH HANDLEBAR (HERITAGE SOFTAIL CLASSIC SHOWN)



B. NARROW BEACH HANDLEBAR (FAT BOY SHOWN)

\*NOTE: Installation of some handlebars and risers may require a change in clutch and/or throttle cable and brake lines for some models. Handlebar height is regulated in many areas. Check local laws before installation.

*Notice: The prices appearing in this catalog are the manufacturer's suggested retail prices. Actual retail prices may vary.*

# CONTROLS 625

## Handlebars



**C. HOLLYWOOD HANDLEBAR**  
(SPORTSTER FORTY-EIGHT SHOWN)

### C. HOLLYWOOD HANDLEBAR\*

Original Equipment on the Softail Slim® model, this traditional Hollywood-styled handlebar combines the laid-back riding attitude of the '40s with a shape that's perfect for today's new school stripped-down bobbers. With its limited rise, narrow profile and gentle pull back shape, this bar captures the look of a classic bar without the wide beach bar riding position.

**55800050** Gloss Black. **\$129.95**

Fits '10-later XL1200X, '06-later FXDB, '10-later FXDWG, '00-later FLSTC, FLSTF, FLSTFB and '08-later FLSTN models. Requires separate purchase of additional installation components.

See your Dealer for cables, lines and additional installation components required, or visit [www.H-D.com/store](http://www.H-D.com/store) and search part number 55800050.

### D. CROSS BONES® NARROW BEACH HANDLEBAR – BLACK\*

This black 1.0" handlebar is unique to the FL Softail® Springer™ models. The narrow beach bar style captures the attitude of traditional beach bars, without the wide riding position. Finish the blacked-out look with complementing Diamond-Black cables and brake lines. Installation requires separate purchase of additional components.

**56940-09** Satin Black. **\$79.95**

Fits '08-'11 FLSTSB and '05-'07 FLSTSC models. Requires separate purchase of additional installation components.

See your Dealer for cables, lines and additional installation components required, or visit [www.H-D.com/store](http://www.H-D.com/store) and search part number 56940-09.



**D. CROSS BONES NARROW BEACH HANDLEBAR – BLACK**

\*NOTE: Installation of some handlebars and risers may require a change in clutch and/or throttle cable and brake lines for some models. Handlebar height is regulated in many areas. Check local laws before installation.

#### Model Family Fitment:

■ V-ROD   ■ SPORTSTER   ■ DYNA  
■ SOFTAIL   ■ TOURING

Notice: The prices appearing in this catalog are the manufacturer's suggested retail prices. Actual retail prices may vary.



# 626 CONTROLS

## Handlebars

### A. SPORTSTER® DRAG BAR\*

Nothing says minimalist like a classically simple drag bar. Shaped to give the Nightster™ and Iron 883™ models an aggressive riding profile, this satin black 1.0" Drag Bar features 0" of rise and 4.0" of pull back to provide an excellent combination of forward positioning and wrist control.

**55800035** Satin Black. **\$89.95**

Fits '07-later XL models with 2.2 or 3.3 gallon fuel tank (except XL1200X). Does not fit XL883C, XL883R, XL1200C, XL1200L, XL1200R, '11-later XL883L or models equipped with 4.5 gallon large capacity fuel tank. All models require separate purchase of additional components.

*See your Dealer for cables, lines and additional installation components required, or visit [www.H-D.com/store](http://www.H-D.com/store) and search part number 55800035.*

### B. FAT DRAG HANDLEBAR\*

Complete the transition to the "dark side." Elegant satin-black finished handlebar retains the comfortable contour of the Original Equipment bar and complements the black finished hand controls and mirrors.

**55977-09** Satin Black. **\$169.95**

Fits '08-later FXDF, '10-later FXDWG, '13-later FXDB, '99-later FXST, FXSTB and '10-later FLSTF and FLSTFB models. All models require separate purchase of additional components.

*See your Dealer for cables, lines and additional installation components required, or visit [www.H-D.com/store](http://www.H-D.com/store) and search part number 55977-09.*



A. SPORTSTER DRAG BAR – SATIN BLACK



B. FAT DRAG HANDLEBAR – SATIN BLACK

\*NOTE: Installation of some handlebars and risers may require a change in clutch and/or throttle cable and brake lines for some models. Handlebar height is regulated in many areas. Check local laws before installation.

*Notice: The prices appearing in this catalog are the manufacturer's suggested retail prices. Actual retail prices may vary.*

# CONTROLS 627

## Handlebars

### C. STREET SLAMMER BAR\*

Comfort and attitude in one. This Street Slammer drag bar with 7.0" integrated risers offers a stylish alternative to separate curved risers, bar and handlebar clamp combinations and reduces the stretch required to reach traditional straight bars. This 1.25" fat bar is factory drilled to accept hidden control wires for a clean custom look. Available in brilliant chrome or satin black finish.

Fits '06-later FXDB, '08-later FXDF, '01-'05 FXDL, '99-later FXDWG, '12-later FLD, '00-later FXST, FXSTB, FXSTC, FXSTD, FLS, FLSTC, FLSTN, FLSTF, FLSTFB and '03-'13 FLHR, FLHRC models. All models require separate purchase of additional installation components. Does not fit Road King® Models equipped with cruise control, '08 ABS-equipped models, Heated Hand Grips, Hydraulic Clutch Kits, Handlebar Mounted Gauges, Road Tech™ Radio, Softail® Nacelle Kit P/N 67907-96C or Sidecar-equipped models.

<b>55975-08A</b>	Chrome.	<b>\$274.95</b>
<b>55985-10</b>	Satin Black.	<b>\$274.95</b>

See your Dealer for cables, lines and additional installation components required, or visit [www.H-D.com/store](http://www.H-D.com/store) and search part number 55975-08 or 55985-10.

#### Shown with:

#### STREET SLAMMER HANDLEBAR COVER

Required for installation of Street Slammer Bar P/N 55975-08A or 55985-10 on '03-'13 Road King models. All models require separate purchase of additional installation components.

<b>55854-07</b>	Chrome.	<b>\$54.95</b>
<b>55876-10</b>	Gloss Black.	<b>\$54.95</b>



C. STREET SLAMMER BAR – CHROME (ROAD KING SHOWN)



C. STREET SLAMMER BAR – SATIN BLACK (FAT BOY SHOWN)

\*NOTE: Installation of some handlebars and risers may require a change in clutch and/or throttle cable and brake lines for some models. Handlebar height is regulated in many areas. Check local laws before installation.

#### Model Family Fitment:

■ V-ROD	■ SPORTSTER	■ DYNA
■ SOFTAIL	■ TOURING	

Notice: The prices appearing in this catalog are the manufacturer's suggested retail prices. Actual retail prices may vary.



## 628 CONTROLS

### Handlebars

#### A. IRON 883™ HANDLEBAR – SATIN BLACK

Add an edgy touch to your Sportster® model. Featuring the same shape, rise and pull back of the Iron 883™ Original Equipment stainless pull back handlebar, this satin black bar provides a choice in customizing style without the need to change cables and brake lines. Original Equipment on XL883N and XL1200X models.

**55800345** **\$89.95**

Fits '07-later XL883L, XL1200C, XL1200T and XL1200V models. Installation requires separate purchase of additional components. Original Equipment on XL883N and XL1200X models.

See your Dealer for cables, lines and additional installation components required, or visit [www.H-D.com/store](http://www.H-D.com/store) and search part number 55800345.

#### B. MINI-APE HANDLEBAR\*

Raise your fists to the wind. This 1.0" diameter Mini-Ape Handlebar features a conservative rise and bend for rider comfort and a chrome or satin black finish that complements the aggressive look of the Nightster™ and Street Bob® models.

Fits '07-later XL883L, XL883N, XL1200L, XL1200N, XL1200T, XL1200V and XL1200X models. Also fits '06-later FXDB and '96-'05 FXDWG models with Original Equipment handlebar P/N 58079-93. XL models require separate purchase of additional components.

**56079-93T** Chrome. **\$89.95**

**56075-07** Satin Black. **\$89.95**

See your Dealer for cables, lines and additional installation components required, or visit [www.H-D.com/store](http://www.H-D.com/store) and search part number 56079-93 or 56075-07.

NEW



A. IRON 883 HANDLEBAR – SATIN BLACK



B. MINI-APE HANDLEBAR – CHROME



B. MINI-APE HANDLEBAR – SATIN BLACK

\*NOTE: Installation of some handlebars and risers may require a change in clutch and/or throttle cable and brake lines for some models. Handlebar height is regulated in many areas. Check local laws before installation.

Notice: The prices appearing in this catalog are the manufacturer's suggested retail prices. Actual retail prices may vary.

# CONTROLS 629

## Handlebars



C. CHIZELED HANDLEBAR – CHROME

### C. CHIZELED HANDLEBAR\*

Achieve ultimate cutting edge style. The Chizeled Bar features the edgy profile of the classic "Z" bar and combines the hands-up feel of a mini-ape with the narrow width of a drag bar. The result? A classic chopper attitude. The 1.0" bar replaces mitered and welded corners with cast seamless 90° bends for added strength and style. The cast elbows eliminate sharp internal bends and the bar features removable Bar & Shield plugs to simplify internal wiring.

Fits '07-later XL883L, XL883N, XL1200L, XL1200N, XL1200T, XL1200V and XL1200X models. Also fits '06-later FXDB and '96-'05 FXDWG models with Original Equipment Handlebar P/N 58079-93. XL models require separate purchase of additional components.

<b>55800103</b>	Satin Black.	<b>\$299.95</b>
<b>55800198</b>	Chrome.	<b>\$299.95</b>

See your Dealer for cables, lines and additional installation components required, or visit [www.H-D.com/store](http://www.H-D.com/store) and search part number 55800103 or 55800198.

### D. FAT MINI-APE HANDLEBAR – FXSB SOFTAIL\*

Give your ride a touch of old school style with this 1.25" Fat Ape Handlebar. The 12.0" high bar provides the look and attitude you dream about, but remains comfortable during long rides. This Mini-Ape Bar is factory drilled to accept internal wiring for a clean look. Kit includes chrome-plated handlebar, riser and clamp with gauge mount.

<b>55800252</b>	Chrome.	<b>\$419.95</b>
-----------------	---------	-----------------

Fits '13-later FXSB models. Separate purchase of additional components required.

See your Dealer for cables, lines and additional installation components required, or visit [www.H-D.com/store](http://www.H-D.com/store) and search part number 55800252.



C. CHIZELED HANDLEBAR – SATIN BLACK



D. FAT MINI-APE HANDLEBAR – FXSB SOFTAIL

\*NOTE: Installation of some handlebars and risers may require a change in clutch and/or throttle cable and brake lines for some models. Handlebar height is regulated in many areas. Check local laws before installation.

#### Model Family Fitment:

<span style="display: inline-block; width: 10px; height: 10px; background-color: gray; border: 1px solid black;"></span> V-ROD	<span style="display: inline-block; width: 10px; height: 10px; background-color: yellow; border: 1px solid black;"></span> SPORTSTER	<span style="display: inline-block; width: 10px; height: 10px; background-color: red; border: 1px solid black;"></span> DYNA
<span style="display: inline-block; width: 10px; height: 10px; background-color: purple; border: 1px solid black;"></span> SOFTAIL	<span style="display: inline-block; width: 10px; height: 10px; background-color: teal; border: 1px solid black;"></span> TOURING	

Notice: The prices appearing in this catalog are the manufacturer's suggested retail prices. Actual retail prices may vary.



# 630 CONTROLS

## Handlebars

### A. 16" FAT APE HANDLEBAR KIT WITH RISER\*

Reach for the sky. This brawny 1.25" Ape Handlebar is the ideal choice for the long-armed rider or anyone looking for that classic "fists in the wind" riding profile. Factory drilled to allow internal wiring, the show-quality chrome or satin-black finish complements your bike's overall design sense. This 16.0" high bar and riser combination provides the look you crave around town and the bar can be rotated in the clamp and locked down to place your hands in your ideal open-road riding position. Handlebar kit includes matching riser and custom handlebar clamp that conceals the wire exit for a clean look.

Fits '99-later FXDWG, '06-later FXDB, '08-later FXDF, '12-later FLD, '00-later FXST, FXSTB, FXSTC, FLS, FLSTC, FLSTF, FLSTFB, FLSTN, FXCW, FXCWC and '03-later FLHR and FLHRC models (except '14-later models equipped with H-D® Detachables™ Docking Kit P/N 52300131). All models require separate purchase of additional installation components. Does not fit with Heated Hand Grips, Hydraulic Clutch Kits, handlebar-mounted gauges, Road Tech™ Radio or Softail® Nacelle Kit P/N 67907-96C.

<b>56942-10B</b>	Chrome.	<b>\$329.95</b>
<b>55857-10B</b>	Satin Black.	<b>\$329.95</b>

See your Dealer for cables, lines and additional installation components required, or visit [www.H-D.com/store](http://www.H-D.com/store) and search part number 56942-10 or 55857-10.

### Shown with ROAD KING® HANDLEBAR COVER FOR 1.25" APE HANDLEBARS

Required for installation of 12.0" and 16.0" Fat Ape Handlebars on Road King® models.

Fits '03-'13 FLHR and FLHRC models equipped with handlebars P/N 56942-10B, 55857-10B, 56832-04C and 55859-10B.

<b>55879-10</b>	Chrome.	<b>\$54.95</b>
<b>55881-10</b>	Gloss Black.	<b>\$54.95</b>

Fits '14-later FLHR and FLHRC models equipped with handlebars P/N 56942-10B, 55857-10B, 56832-04C and 55859-10B. Does not fit FLHRSE models.

<b>55800289</b>	Chrome.	<b>\$49.95</b>
<b>55800290</b>	Gloss Black.	<b>\$49.95</b>



A. 16" FAT APE HANDLEBAR KIT WITH RISER – CHROME



A. 16" FAT APE HANDLEBAR KIT WITH RISER – SATIN BLACK

\*NOTE: Installation of some handlebars and risers may require a change in clutch and/or throttle cable and brake lines for some models. Handlebar height is regulated in many areas. Check local laws before installation.

Notice: The prices appearing in this catalog are the manufacturer's suggested retail prices. Actual retail prices may vary.

# CONTROLS 631

## Handlebars

### B. 12" FAT MINI-APE HANDLEBAR KIT WITH RISER\*

Big and beefy in the chopper tradition, this 1.25" Mini-Ape Handlebar is the perfect finish to an "old school" ride. Factory drilled to allow internal wiring, the show-quality chrome or satin-black finish reflects your attention to custom details. This 12.0" high bar and riser combination provides the look and attitude you dream about, but remains comfortable over the long haul. Handlebar kit includes matching riser and custom handlebar clamp that conceals the wire exit for a clean look.

Fits '99-later FXDWG, '06-later FXDB, '08-later FXDF, '12-later FLD, '00-later FLS, FLSTC, FLSTF, FLSTFB, FLSTN, FXCW, FXCWC, FXST, FXSTB, FXSTC and '03-later FLHR and FLHRC models. All models require separate purchase of additional installation components. Does not fit with Heated Hand Grips, Hydraulic Clutch Kits, handlebar-mounted gauges, Road Tech™ Radio or Softail® Nacelle Kit P/N 67907-96C.

<b>56832-04C</b>	Chrome.	<b>\$309.95</b>
<b>55859-10B</b>	Satin Black.	<b>\$309.95</b>

See your Dealer for cables, lines and additional installation components required, or visit [www.H-D.com/store](http://www.H-D.com/store) and search part number 56832-04 or 55859-10.



B. 12" FAT MINI-APE HANDLEBAR KIT WITH RISER – CHROME



B. 12" FAT MINI-APE HANDLEBAR KIT WITH RISER – SATIN BLACK

\*NOTE: Installation of some handlebars and risers may require a change in clutch and/or throttle cable and brake lines for some models. Handlebar height is regulated in many areas. Check local laws before installation.

#### Model Family Fitment:

- V-ROD
- SPORTSTER
- DYNA
- SOFTAIL
- TOURING

Notice: The prices appearing in this catalog are the manufacturer's suggested retail prices. Actual retail prices may vary.



## 632 CONTROLS

### Handlebars

#### A. ROAD KING® FAT HANDLEBAR

Similar to Original Equipment handlebar on the '14 CVO™ Road King® model, this beefy 1.25" handlebar places the rider in a laid-back riding posture. This handlebar provides 2.0" of additional pull back and a 1.0" lower hand position than the Original Equipment Road King bar. The 1.25" diameter bar allows you to tuck the wires inside the bar for a clean, custom look.

Fits '14-later Road King models. All models require separate purchase of additional components for installation.

**55800386** Chrome. **\$259.95**

**55800388** Gloss Black. **\$259.95**

See your Dealer for cables, lines and additional installation components required, or visit [www.H-D.com/store](http://www.H-D.com/store) and search part number 55800386 or 55800388.

#### Also available:

#### HIDDEN FAT BAR RISER KIT

This riser enables installation of the 1.25" Road King Fat Handlebar on FLHR and FLHRC models. Riser fits beneath the Original Equipment handlebar cover to maintain the classic nacelle headlamp style. Riser components are zinc plated for corrosion protection.

**55900067** **\$59.95**

Fits '14-later FLHR and FLHRC models with 1.25" diameter handlebars.

#### B. ROAD KING FAT HANDLEBAR – '08-'13 MODELS\*

Similar to Original Equipment handlebar on the '08 CVO Road King model, this beefy 1.25" chrome handlebar is designed to be compatible for use with TGS-equipped Road King models. This handlebar provides a flatter hand position, 2.0" more rise than the stock bar and allows you to tuck the wires inside the bar for a clean, custom look.

**56032-08** Chrome. **\$259.95**

Fits '08-'13 Road King models. All models require separate purchase of additional components for installation. Does not fit with Heated Hand Grips, Handlebar-mounted Gauges or Road Tech™ Riser Mount Radio Kit. Does not fit '08 ABS-equipped models.

See your Dealer for cables, lines and additional installation components required, or visit [www.H-D.com/store](http://www.H-D.com/store) and search part number 56032-08.

#### C. ROAD KING/ROAD GLIDE® REDUCED REACH® HANDLEBAR\*

This 1.0" diameter chrome bar has 2.0" more pull back compared to the stock Road King handlebar. Accepts internal wiring for a clean look. The neutral hand position is comfortable for the long haul and the narrow width and pull back design produces a major ergonomic change.

**56166-08** Chrome. **\$104.95**

Fits '08-later FLHR, FLHRC and '08-'13 FLTR, FLTRU and FLTRX models. Does not fit '08 ABS-equipped models, Sidecar-equipped models, Heated Hand Grips with internal switch wiring, Handlebar-mounted Gauges or Road Tech Riser Mount Radio kit. All models require separate purchase of additional components for installation.

**56152-04B** Chrome. **\$104.95**

Fits '02-'07 Road King models. Not for use with Sidecar-equipped models. All models require separate purchase of additional components for installation.

See your Dealer for cables, lines and additional installation components required, or visit [www.H-D.com/store](http://www.H-D.com/store) and search part number 56166-08 or 56152-04.

\*NOTE: Installation of some handlebars and risers may require a change in clutch and/or throttle cable and brake lines for some models. Handlebar height is regulated in many areas. Check local laws before installation.

Notice: The prices appearing in this catalog are the manufacturer's suggested retail prices. Actual retail prices may vary.

NEW



A. ROAD KING FAT HANDLEBAR



B. ROAD KING FAT HANDLEBAR – '08-'13 MODELS



C. ROAD KING/ROAD GLIDE REDUCED REACH HANDLEBAR

# CONTROLS 633

## Handlebars



D. ROAD KING/ROAD GLIDE TALLBOY HANDLEBAR

### D. ROAD KING®/ROAD GLIDE® TALLBOY® HANDLEBAR\*

Designed to provide extra touring comfort for the Road King® rider, this 1.0" diameter chrome bar is 2.0" higher and 1.5" narrower compared to the stock Road King handlebar.

**56180-08** Chrome. **\$99.95**

Fits '08-later FLHR, FLHRC, '15-later FLRT and '08-'13 FLTR, FLTRU and FLTRX models. Does not fit with '08 ABS-equipped models, Sidecar-equipped models, Heated Hand Grips with internal switch wiring, Handlebar Mounted Gauges or Road Tech™ Riser Mount Radio kit. All models require separate purchase of additional components for installation.

See your Dealer for cables, lines and additional installation components required, or visit [www.H-D.com/store](http://www.H-D.com/store) and search part number 56180-08.

### E. ROAD KING/ROAD GLIDE TALLBOY HANDLEBAR – '96-'07 MODELS\*

Designed to provide extra comfort for the Road King rider, this chrome bar is 4.5" higher and 2.0" narrower than the stock handlebar found on '96-'99 Road King models and 3.5" higher and 1.5" narrower than stock handlebar on '00-'01 Road King models. Many models require no additional cables or hoses for installation.

**55954-00** Chrome. **\$99.95**

Fits '96-'07 Road King and '02-'07 Road Glide® models.

See your Dealer for cables, lines and additional installation components required, or visit [www.H-D.com/store](http://www.H-D.com/store) and search part number 55954-00.



E. ROAD KING/ROAD GLIDE TALLBOY HANDLEBAR – '96-'07 MODELS

### F. ROAD KING/ROAD GLIDE HERITAGE STYLE HANDLEBAR\*

Designed to provide extra touring comfort for the Road King or Road Glide rider, this 1.0" diameter stainless steel bar has 3.0" more pull back compared to the stock '08-'13 Road King handlebar. Heritage Bar has the same dimensions as the '14-later Road King Original Equipment bar.

Fits '08-later FLHR, FLHRC and '08-'13 FLTR, FLTRU and FLTRX models. All models require separate purchase of additional components. Does not fit models with Sidecar, Heated Hand Grips with internal switch wiring, Handlebar Mounted Gauges or Road Tech Riser Mount Radio.

**55864-09** Satin Black. **\$94.95**

**56902-08** Polished Stainless Steel. **\$94.95**

See your Dealer for cables, lines and additional installation components required, or visit [www.H-D.com/store](http://www.H-D.com/store) and search part number 55864-09 or 56902-08.



F. ROAD KING/ROAD GLIDE HERITAGE STYLE HANDLEBAR

\*NOTE: Installation of some handlebars and risers may require a change in clutch and/or throttle cable and brake lines for some models. Handlebar height is regulated in many areas. Check local laws before installation.

#### Model Family Fitment:

■ V-ROD    ■ SPORTSTER    ■ DYNA  
■ SOFTAIL    ■ TOURING

Notice: The prices appearing in this catalog are the manufacturer's suggested retail prices. Actual retail prices may vary.



## 634 CONTROLS

### Handlebars

#### A. ROAD GLIDE® HANDLEBAR – GLOSS BLACK\*

Come over to the dark side. This gloss black 1.25" handlebar features the same shape, rise and pull back dimensions as the Original Equipment bar, so no additional cables or lines are required.

**55800379** **\$199.95**

Fits '15-later Road Glide® models.

#### B. ROAD GLIDE FAT MINI-APE HANDLEBAR – '08-'13 MODELS\*

Hang 'em high. Across town or cross country, this classic-shaped Fat Mini Ape Handlebar adds a touch of old school style to your modern urban bagger. Designed for Road Glide models, this beefy 1.25" bar features 10.0" of rise and minimal pull back that help achieve a cool yet comfortable riding profile. The brilliant chrome finish and concealed wiring provide a show-quality look that's built for the open road. The kit includes a custom riser designed for installation on Road Glide models.

**55800094** Chrome. **\$344.95**

Fits '09-'13 FLTR, FLTRX and FLTRU models. All models require separate purchase of additional installation components. Does not fit with Heated Hand Grips, Hydraulic Clutch Kits or Handlebar-mounted Gauges.

*See your Dealer for cables, lines and additional installation components required, or visit [www.H-D.com/store](http://www.H-D.com/store) and search part number 55800094.*

NEW



A. ROAD GLIDE HANDLEBAR – GLOSS BLACK  
'15-LATER MODELS



B. ROAD GLIDE FAT MINI-APE HANDLEBAR –  
'09-'13 MODELS

\*NOTE: Installation of some handlebars and risers may require a change in clutch and/or throttle cable and brake lines for some models. Handlebar height is regulated in many areas. Check local laws before installation.

Notice: The prices appearing in this catalog are the manufacturer's suggested retail prices. Actual retail prices may vary.

#### Model Family Fitment:

■ V-ROD   ■ SPORTSTER   ■ DYNA  
■ SOFTAIL   ■ TOURING

# CONTROLS 635

## Handlebars

### C. BATWING MINI-APE HANDLEBAR

Throw your fists in the air with these 12.0" ape hangers. Shaped to rest your hands just above the top of the classic batwing fairing, these bars feature a tall stance and minimal amount of pull back that help to achieve a cool yet comfortable riding profile. Finished in brilliant chrome or satin black, these 1.0" handlebars accept internal wiring for a clean look.

Fits '09-later Electra Glide®, Street Glide®, FLHXXX and FLHTCUTG models (except '10-'13 FLHTK and CVO™ models). All models require separate purchase of additional components for installation. '09-'13 FLHX and models with fairing-mount mirrors require separate purchase of handlebar-mounted mirrors and Fairing Plugs. Not for use with heated hand grips.

<b>57474-11</b>	Chrome.	<b>\$194.95</b>
<b>57485-11</b>	Satin Black.	<b>\$194.95</b>

See your Dealer for cables, lines and additional installation components required, or visit [www.H-D.com/store](http://www.H-D.com/store) and search part number 57474-11 or 57485-11.



C. BATWING MINI-APE HANDLEBAR – CHROME



C. BATWING MINI-APE HANDLEBAR – SATIN BLACK

\*NOTE: Installation of some handlebars and risers may require a change in clutch and/or throttle cable and brake lines for some models. Handlebar height is regulated in many areas. Check local laws before installation.

#### Model Family Fitment:

■ V-ROD	■ SPORTSTER	■ DYNA
■ SOFTAIL	■ TOURING	

Notice: The prices appearing in this catalog are the manufacturer's suggested retail prices. Actual retail prices may vary.



## 636 CONTROLS

### Handlebars

#### A. BATWING SATIN BLACK HANDLEBAR\*

Come over to the dark side. This satin black handlebar features the same shape, rise and pull back dimensions as the Original Equipment bar, so no additional cables or lines are required.

**55861-09** **\$89.95**

Fits '08-later FLHT, FLHTC, FLHTCU, FLHTK, FLHX, FLHXS and '09-later FLHTCUTG and FLHXXX models. No additional cables or lines required.

#### B. BATWING TALLBOY® HANDLEBAR\*

This 1.0" chrome-plated handlebar is shaped to provide a comfortable reach for a rider with longer arms. Handlebar is approximately 1.5" taller and 2.0" further from the rider than the Original Equipment Electra Glide handlebar.

**56184-08** Chrome. **\$154.95**

Fits '08-later Electra Glide, Street Glide®, FLHXXX and FLHTCUTG models (except '10-'13 FLHTK and CVO™ models). All models require separate purchase of additional components. '09-'13 FLHX and models with fairing-mount mirrors require separate purchase of handlebar-mounted mirrors and Fairing Plugs. Does not fit '08 ABS-equipped models or Sidecar-equipped models.

**56964-07** Chrome. **\$154.95**

Fits '02-'07 Electra Glide and Street Glide models. All models require separate purchase of additional components. FLHX and models with fairing mount mirrors require separate purchase of handlebar-mounted mirrors and Fairing Plugs P/N 732 (Qty 2) and 755 (Qty 2). Does not fit models equipped with Heated Hand Grips with internal switch wiring, Hydraulic Clutch Kits or Sidecar.

*See your Dealer for cables, lines and additional installation components required, or visit [www.H-D.com/store](http://www.H-D.com/store) and search part number 56184-08 or 56964-07.*



A. BATWING SATIN BLACK HANDLEBAR



B. BATWING TALLBOY HANDLEBAR – ('08-LATER MODEL SHOWN)

\*NOTE: Installation of some handlebars and risers may require a change in clutch and/or throttle cable and brake lines for some models. Handlebar height is regulated in many areas. Check local laws before installation.

*Notice: The prices appearing in this catalog are the manufacturer's suggested retail prices. Actual retail prices may vary.*

# CONTROLS 637

## Handlebars



C. ELECTRA GLIDE CHROME HANDLEBAR

### C. ELECTRA GLIDE® CHROME HANDLEBAR

This high-quality chrome-plated handlebar is designed to be compatible for use with TGS-equipped '08 Electra Glide® models. Replace your stock polished bar with this 1.0", chrome handlebar that allows you to tuck the wires inside the bar for a clean, finished look.

**56036-08** Chrome. **\$154.95**

Fits '08-later Electra Glide and Street Glide® models (except CVO™). Does not fit Trike models. All models require separate purchase of additional components. Does not fit '08 ABS-equipped models or Sidecar-equipped models.

See your Dealer for cables, lines and additional installation components required, or visit [www.H-D.com/store](http://www.H-D.com/store) and search part number 56036-08.

### D. BATWING REDUCED REACH® HANDLEBAR\*

These high-quality, handlebars are designed to bring the controls 2.0" closer to the rider for increased comfort. Especially helpful for shorter riders or those with short arms.

**56176-08** Chrome. **\$154.95**

Fits '08-later Electra Glide, Street Glide, FLHXXX and FLHTCUTG models (except '10-'13 FLHTK and CVO). All models require separate purchase of additional components. '08-'13 FLHX and models with fairing-mount mirrors require separate purchase of handlebar-mounted mirrors and Fairing Plugs. Does not fit Sidecar-equipped models.

**55914-98** Polished Stainless. **\$154.95**

Fits '02-'07 Electra Glide and Street Glide models. All models require separate purchase of additional components. '08-'13 FLHX and models with fairing-mount mirrors require separate purchase of handlebar-mounted mirrors and Fairing Plugs P/N 732 (Qty 2) and 755 (Qty 2). Does not fit models equipped with Heated Hand Grips with internal switch wiring, Hydraulic Clutch Kits or Sidecar.

See your Dealer for cables, lines and additional installation components required, or visit [www.H-D.com/store](http://www.H-D.com/store) and search part number 56176-08 or 55914-98.



E. BATWING REDUCED REACH HANDLEBAR

\*NOTE: Installation of some handlebars and risers may require a change in clutch and/or throttle cable and brake lines for some models. Handlebar height is regulated in many areas. Check local laws before installation.

#### Model Family Fitment:

■ V-ROD    ■ SPORTSTER    ■ DYNA  
■ SOFTAIL    ■ TOURING

Notice: The prices appearing in this catalog are the manufacturer's suggested retail prices. Actual retail prices may vary.



## RIDER BASICS

You may think you are perfectly happy with the way your bike is adjusted. But that doesn't mean that it is correctly set up for you. We get used to our bikes – our muscles become trained and we end up accommodating the bike. It is far better to take the time to make the bike accommodate you.

If you are satisfied with your handlebar's width and wrist position, but wish it was just a little higher, lower or closer to you, your dealer can recommend a set of handlebar risers that move the bar into your comfort zone.

## ADJUSTING YOUR HAND POSITION



### STOCK HANDLEBAR

Just about every model of Harley-Davidson® motorcycle comes with a different stock handlebar. Selected to complement the style of the bike, the handlebar may be the ideal shape for many riders, but of course, not everyone has the same physical characteristics.

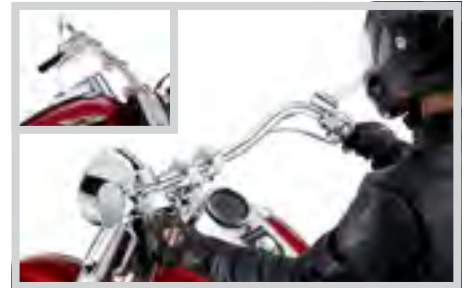

### STOCK HANDLEBAR WITH RISERS

If the stock handlebar has the correct width and hand position for you, but seems just a little too far away, we offer riser kits that bring the controls within reach. Straight and curved risers are available for many model and handlebar combinations.

## RISER DIMENSIONS

### ORIGINAL EQUIPMENT RISER DIMENSIONS

DESCRIPTION	BAR DIAMETER (IN)	HEIGHT (IN)	PULL BACK (IN)	FINISH
Touring & Trike	1.00	1.70	0.00	Cast Alum
Softail – FLSTC & FLS	1.00	1.94	0.39	Chrome
Softail – FLSTF & FLSTFB	1.25	2.40	0.87	Chrome
Softail – FLSTN	1.00	4.45	1.30	Chrome
Softail – FLSTSB	1.00	2.60	0.00	Black
Softail – FLST	1.00	1.86	0.00	Chrome
Softail – FLSTSE	1.25	2.28	0.60	Chrome
Softail – FXSB	1.25	4.00	1.15	Chrome
Softail – FXSBSE	1.25	2.00	0.00	Chrome
Softail – FXST	1.00	4.43	1.50	Polished Alum
Softail – FXSTC	1.00	1.94	0.39	Chrome
Softail – FXSTB	1.00	6.00	0.00	Chrome
Dyna – FLD	1.00	3.10	1.18	Chrome
Dyna – FXD	1.00	1.86	0.00	Black, Wrinkle
Dyna – FXDC	1.00	1.86	0.00	Chrome
Dyna – FXDB	1.00	1.00	n/a	Polished Alum
Dyna – FXDL & FXDB	1.00	4.39	1.61	Polished Alum
Dyna – FXDWG	1.25	2.27	0.60	Chrome
Dyna – FXDF & FXDWG	1.25	5.00	0.60	Black, Gloss
XL – 883C & 1200C	1.00	4.73	1.13	Chrome
XL – 883N & 1200N	1.00	2.07	0.00	Black, Wrinkle
XL – 883L & 883R	1.00	2.07	0.00	Black
XL – 1200L, 1200CP & 1200V	1.00	1.86	0.00	Chrome
XL – 1200X	1.00	0.94	n/a	Black, Gloss
VRSC – VRSCD & VRSCDX	1.00	2.68	0.40	Black

### ACCESSORY RISER DIMENSIONS\*

KIT P/N	DESCRIPTION	BAR DIAMETER (IN)	HEIGHT (IN)	PULL BACK (IN)	FINISH
55996-09	Black Fat Risers	1.25	5.0	0.6	Black, Gloss
56269-09	Curved Pull Back, 4.0"	1.25	4.0	1.3	Chrome
56267-09	Curved Pull Back, 6.0"	1.25	6.0	1.7	Chrome
56066-82A	Curved Riser, 4.0"	1.00	4.4	1.5	Chrome
56266-09	Curved Riser, 6.0"	1.00	6.0	1.7	Chrome
55900023	Deluxe Pull Back Riser	1.00	4.4	0.8	Chrome
56931-10	Fat One-Piece Riser, Black	1.25	4.1	0.0	Black, Gloss
56929-10	Fat One-Piece Riser, Chrome	1.25	4.1	0.0	Chrome
56916-07	Fat-Bar Risers	1.25	3.6	0.0	Chrome
46809-09	Riser Kit for Nacelle	1.00	1.9	0.0	Chrome
56789-05	Road King Fat Riser	1.25	1.6	0.0	Cast Alum
56296-05	Slotted Riser	1.00	5.2	1.5	Chrome
56063-82A	Straight Riser, 4.0"	1.00	4.0	0.0	Chrome
56223-98	Straight Riser, 6.0"	1.00	6.0	0.0	Chrome
55900008	VRSCF H'bar Replacement Riser	1.00	1.2	0.6	Satin Black
55900067	FLHR Hidden Riser Kit	1.25	1.7	0.0	Cast Alum

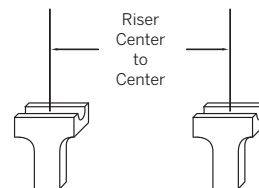

## FIT SHOP TIPS



Here are a few options to consider when outfitting your bike to fit you. Find your model and flip to the pages for more information. For more details, visit [h-d.com/fitshop](http://h-d.com/fitshop).

Getting the fit right may be as simple as adjusting the Original Equipment handlebar and controls. With the bike blocked in the upright position and you in the saddle, your Dealer can loosen the handlebar clamp and rotate the bar for a closer match to your ideal fit.

Once the grips fall naturally to hand, your Dealer can also adjust the hand control lever position. Rotating the switches and levers to a level position puts your wrists in a relaxed position and reduces the strain of lifting your fingers to reach a too-high lever.

\*NOTE: Installation of some handlebars and risers may require a change in clutch and/or throttle cable and brake hose for some models. Handlebar height is regulated in many areas. Check local laws before installation.

# CONTROLS 639

## Handlebar Risers



A. FAT RISER KIT – CHROME



A. FAT RISER KIT – GLOSS BLACK

### A. FAT RISER KIT\*

This riser features a one-piece base that is designed for use with internally-wired 1.25" handlebars and provides a skirt that conceals the wiring's exit from the bar. The matching handlebar clamp ties it all together. Available in mirror-chrome or gloss black finish, the kit includes riser, matching handlebar clamp and clamp hardware.

Fits most 1.25" diameter handlebars. Does not fit FXSB, FXSBSE and Springer™ models. Requires separate purchase of additional components. Riser height 4.1".

<b>56929-10</b>	Chrome.	<b>\$129.95</b>
<b>56931-10</b>	Gloss Black.	<b>\$129.95</b>

### B. CURVED PULL BACK FAT RISERS\*

These chrome-plated Curved Pull Back Risers provide a comfortable riding position for those who like the shape, width and hand position of their current handlebar, but wish it was closer. For an ergonomically-friendly ride, these risers can be combined with a Harley-Davidson® Reduced Reach® Seat and Profile® Low suspension components to reduce arm stretch and to plant the feet firmly on the ground.

Fits most 1.25" diameter handlebars. Does not fit FXSB, FXSBSE and Springer models. Requires separate purchase of additional components.

<b>56269-09</b>	4" Curved Riser.	<b>\$174.95</b>
<b>56267-09</b>	6" Curved Riser.	<b>\$179.95</b>



B. CURVED PULL BACK FAT RISERS – 4"



B. CURVED PULL BACK FAT RISERS – 6"

### C. FAT BAR RISER KIT\*

Go phat with bold chrome-plated risers. Hidden fasteners create a clean, seamless look. Kit includes all necessary mounting hardware.

**56916-07** **\$124.95**

Fits most 1.25" diameter handlebars. Does not fit FXSB, FXSBSE and Springer models. Requires separate purchase of additional components. Riser height 3.6".

### D. FAT HANDLEBAR RISER KIT – BLACK\*

Add a splash of darkness to your front end with these blacked out risers. First introduced on the FXDF model, these risers feature a gloss black finish that will look good with any black or chrome bar.

**55996-09** **\$139.95**

Fits most 1.25" diameter handlebars. Does not fit FXSB, FXSBSE and Springer models. Requires separate purchase of additional components. Riser height 5.0".



C. FAT BAR RISER KIT



D. FAT HANDLEBAR RISER KIT – BLACK

\*NOTE: Installation of some handlebars and risers may require a change in clutch and/or throttle cable and brake lines for some models. Handlebar height is regulated in many areas. Check local laws before installation.

#### Model Family Fitment:

 V-ROD	 SPORTSTER	 DYNA
 SOFTAIL	 TOURING	

Notice: The prices appearing in this catalog are the manufacturer's suggested retail prices. Actual retail prices may vary.



# 640 CONTROLS

## Handlebar Risers

### A. SOFTAIL SLIM® PULL BACK RISER KIT\*

Ideal for riders with a short reach or for those that prefer an upright riding position, these curved risers and the matching handlebar clamp are shaped to put the Original Equipment Softail Slim® handlebar closer to the rider. Designed for easy installation, these 4.5" high risers are compatible with the stock control cables for a low-cost conversion. Provides 1.75" of rise and 1.5" of additional pull back when compared to the stock FLS riser.

**55900023 \$179.95**

Fits most '12-later FLS models with no additional components. '15-later FLS models equipped with ABS brakes require separate purchase of Brake Line P/N 41800300. Also fits most 1.0" diameter handlebars with separate purchase of additional components. Does not fit Springer™ models. Riser height 4.5".



A. SOFTAIL SLIM PULL BACK RISER KIT

### B. HANDLEBAR RISER KITS\*

These chrome-plated risers provide a comfortable riding position for those who like the shape, width and hand position of their current 1.0" handlebar, but wish it was closer. For an ergonomically-friendly ride, these risers can be combined with a Harley-Davidson® Reduced Reach® forward-position seat and Profile® Low suspension components to reduce arm stretch and to plant the feet firmly on the ground. Finish off the look with a Harley-Davidson decorative handlebar clamp kit.

Fits most 1.0" handlebars. Does not fit Springer™ models. Installation may require separate purchase of handlebar clamp. Installation also may affect fitment of handlebar-mounted instruments.

<b>56066-82A</b>	4.0" Curved Risers.	<b>\$144.95</b>
<b>56063-82A</b>	4.0" Straight Risers.	<b>\$139.95</b>
<b>56266-09</b>	6.0" Curved Risers.	<b>\$149.95</b>
<b>56223-98</b>	6.0" Straight Risers.	<b>\$144.95</b>



B. HANDLEBAR RISER KIT – STRAIGHT



B. HANDLEBAR RISER KIT – CURVED

### C. BILLET HANDLEBAR RISER HARDWARE

Provides a highly polished and plated, machined steel, conical shaped washer. Chrome socket head cap screw is countersunk into the washer upon installation for a very clean look. Screws are also chrome-plated. Looks great with Original Equipment or billet triple trees.

**63026-05 \$44.95**

Fits '91-later Dyna® models (except '08-later FXDB and FXDF) and '97-later FXSB, FXST, FXSTB, FXSTC and FXSTD models. Also fits '93-'00 FXR models.



C. BILLET HANDLEBAR RISER HARDWARE



### D. HANDLEBAR RISER HARDWARE – CHROME

Finish the show-winning look with brilliant chrome hardware. Manufactured to Original Equipment specifications, this kit replaces the zinc-plated exposed handlebar riser hardware with chrome-plated bolts and chrome lock washers.

**63027-05 \$9.95**

Fits '91-later Dyna models (except '08-later FXDB) and '97-later FXSB, FXST, FXSTB, FXSTC and FXSTD models. Also fits '93-'00 FXR models.

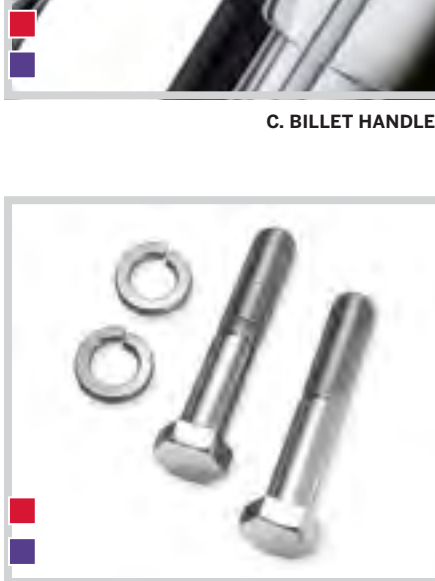

D. HANDLEBAR RISER HARDWARE – CHROME

### E. POLYURETHANE HANDLEBAR RISER BUSHINGS

These Handlebar Riser Bushings replace the Original Equipment stacked rubber and zinc washer combination with a long-lasting polyurethane bushing and cover. The long-lasting one-piece bushing can reduce handlebar vibration.

**56298-03A \$49.95**

Fits '83-later Touring models. Kit includes replacement riser bolts. Does not fit Trike models.

**56165-03 \$39.95**

Fits '97-'03 XL, '86-later Dyna (except FXDB) and Softail® (except Springer models, FXS and FXSTD) models. '86-'93 FL Softail models require use of '94-later Riser Bolts. Will not fit with Chrome Riser Cup Washer Kit P/N 56486-01.



E. POLYURETHANE HANDLEBAR RISER BUSHINGS

\*NOTE: Installation of some handlebars and risers may require a change in clutch and/or throttle cable and brake lines for some models. Handlebar height is regulated in many areas. Check local laws before installation.

Notice: The prices appearing in this catalog are the manufacturer's suggested retail prices. Actual retail prices may vary.

# CONTROLS 641

## Handlebar Risers



**F. RISER CUP WASHER KIT – CHROME**

**F. RISER CUP WASHER KIT – CHROME**

Add a finishing touch to the riser on your bike. This kit includes two styled and chrome-plated washers that replace the standard metal washers below the handlebar risers. Replaces Original Equipment P/N 56159-73.

**56486-01** **\$23.95**

Fits '97-'03 XL, '86-later Dyna® (except FXDB) and Softail® models (except Springer™, FXS and FXSTD). Does not fit with Polyurethane Handlebar Bushings P/N 56165-03.

**G. HANDLEBAR CLAMP HARDWARE KIT – CHROME**

Finish the show-winning look with brilliant chrome hardware. Manufactured to Original Equipment specifications, this kit replaces the zinc-plated exposed handlebar clamp bolts with chrome-plated socket head cap screws.

**94451-05** **\$9.95**

Fits '94-later FXSTS, FXSTSB, FXSTD, FXSTDSE, FLSTS, FLSTSC, FLSTSB and '05-later FLSTN and FXSTSSE/2 models.

**94452-05** **\$9.95**

Fits '94-'06 FXDL, '06 FXD, FXDB, FXDC, FXD35, '94-'05 FXDWG, FXDWG2/3, FXR2/3, '94-later FXST, FXSTB, FXSTC, FLST, '94-'08 FLSTC, '94-'06 FLSTF and '93-'96 FLSTN models.

**94453-05** **\$9.95**

Fits '95-'13 XL models (except XL Custom, XL883N, XL1200L, XL1200N, XL1200V and XL1200X) and '94-'05 FXD, FXDC, FXDX, FXDXT and FXDS-CONV. models.

**94454-05** **\$9.95**

Fits XL1200L, XL1200N, XL1200T, '96-'06 XL883C and XL1200C, '07-later Dyna, '00 FXR4, FLSTFSE/2, FLSTSE/2/3, FXSB and FXSBSE models.

**H. HANDLEBAR CLAMP BOLT COVERS**

Complete the chrome hand control conversion. These thin-wall bolt covers are designed for easy installation over handlebar clamp bolts. The machined brass and chrome-plated covers are corrosion resistant and the internal spring steel retention clip resists vibration and thermal cycling to securely hold the covers in place. Kit includes 4 covers.

**94413-04** **\$18.95**

Fits .3125" socket head handlebar clamp bolts. Does not fit '15-later XG, '07-later FLSTF, '08-later FXCW, FXSB, FXSBSE or Touring models.

**I. WILLIE G SKULL BILLET HANDLEBAR CLAMP**

Machined from solid billet, this sleek clamp offers a simple style.

**56060-01** Willie G Skull. **\$59.95**

Fits '93-'05 FXDL, '93-'05 FXDWG models, '84-'99 FXSTC, '84-'08 FLSTC, '84-'09 FXST, FXSTB and '90-'06 FLSTF models with stock or accessory 1.0" diameter handlebars. Not for use with Road Tech™ Radios.

**J. HANDLEBAR CLAMPS**

Fits '74-later XL, FX, FXR, FX Dyna and FX Softail models with stock and accessory 1.0" diameter handlebar (except '06-later Dyna, XL and Softail models, '96-later XL Customs and '99-later FXR).

**56178-92TA** Gold "Live to Ride". **\$49.95**

**K. CUSTOM HANDLEBAR CLAMPS**

Fits '74-later XL, FX, FXR, FX Dyna and FX Softail models with stock and accessory 1.0" diameter handlebar (except '06-later Dyna, XL and Softail models, '96-later XL Customs and '99-later FXR).

**56170-83TA** Classic Chrome. **\$29.95**

**56567-86B** Bar & Shield. **\$49.95**



**G. HANDLEBAR CLAMP HARDWARE KIT – CHROME**



**H. HANDLEBAR CLAMP BOLT COVERS**

**I. SKULL BILLET HANDLEBAR CLAMP**



**J. HANDLEBAR CLAMPS**

**K. CUSTOM HANDLEBAR CLAMPS**

**Model Family Fitment:**

- V-ROD
- SPORTSTER
- DYNA
- SOFTAIL
- TOURING

*Notice: The prices appearing in this catalog are the manufacturer's suggested retail prices. Actual retail prices may vary.*



GENUINE MOTOR PARTS &amp; ACCESSORIES



2015

## AUDIO & GAUGES

Rock out to your new Harley-Davidson® BOOM!™ Audio sound system as you roll through tiny back roads without a care. Then use your easy-to-use, biker-friendly Road Tech™ GPS system to find your way back home.





## THE CHOICE IS CLEAR

Harley-Davidson® Boom!™ Audio is an exciting collection of integrated audio components designed to combine the maximum number of features with an easy-to-use interface. And because your bike's Original Equipment radio is designed for plug-and-play integration of Boom! Audio equipment, you can easily create the custom sound experience you've always wanted.

### FAIRING SPEAKERS

Capture every note. Designed for maximum performance in the harsh motorcycle environment, these waterproof two-way speakers feature increased sensitivity for 25% louder output, reduced distortion and improved clarity at speed.



### HIDDEN ANTENNA

Hide the antenna inside the fairing for a clean, uncluttered look. Perfect for your slick custom bagger, the Hidden Antenna is the ideal addition to models equipped with H-D® Detachables™ Tour-Pak® luggage.

### SIRIUSXM® SATELLITE RADIO KIT

Satellite Radio allows you to listen to the same channel as you cross the country. With over 200 subscription-based digital channels, you'll always find a program that satisfies your taste for music, news, entertainment and sports.



### BOOM! BOX 6.5GT RADIO

The Boom! Box 6.5GT Touchscreen Infotainment System is the ideal upgrade for models equipped with the standard Boom! Box 4.3 radio. The 6.5GT features AM/FM radio, weather alert, integrated iPod and USB audio device playback, map-based GPS navigation and Bluetooth pairing of mobile phones.

### BIKE-TO-BIKE COMMUNICATIONS KIT

Bike-to-Bike system allows you and your passenger to talk with other riders, even when you are miles apart. Integrated CB features easy to use handlebar controls and will mute the radio while in transmit or receive mode.



### AMPLIFIERS

When loud just isn't loud enough. Rugged Fairing, Tour-Pak® and Saddlebag-mounted amplifiers provide increased volume, lower distortion, reduced clipping and fuller sound that cuts through wind and road noise.



### TOUR-PAK® SPEAKERS

Surround yourself with sound. Forward-facing two-way speakers feature waterproof tweeters and injection-molded woofer cones with high-flux Neodymium magnets and are sized to be a direct replacement for the factory speakers.

### FAIRING LOWER SPEAKERS

Nestled into the glove boxes of your vented fairing lowers, these vibration-tested waterproof two-way speakers feature rider directed tweeters for clear, crisp sound.



### SADDLEBAG LID SPEAKERS

Directionally optimized for improved rider acoustics, these waterproof 5" x 7" two-way speakers turn the latched and gasket-sealed saddlebags into large speaker enclosures for enhanced bass response.





# 646 AUDIO & GAUGES

Boom!™ Audio – '14-'15 Touring

## A. BOOM!™ BOX 6.5GT RADIO KIT

Take a big step up the technology ladder. The Boom!™ Box 6.5GT Infotainment System is the ideal upgrade for Touring models equipped with the standard Boom! Box 4.3 radio. One look at the brilliant 6.5" display and you know that this is something special. Boom! Box 6.5GT features a low distortion 25-watt/channel amplifier that has been optimized for great sound in an open-air environment. The result is cleaner, sharper sound at volumes up to 25% louder than previous Original Equipment radios. Built-in automatic volume control compensates for the increased noise levels as speed increases and automatically adjusts the bass and treble for optimal performance.

The feature-packed radio is factory-equipped with AM/FM radio, weather alert, integrated iPod and USB audio device playback, map-based GPS navigation and Bluetooth pairing of mobile phones. The 6.5GT features can be accessed via the glove-friendly touchscreen, joystick hand controls or with hands-free voice recognition. And it doesn't stop there. Optional Bike-to-Bike communication, SiriusXM® satellite radio, XM weather and traffic services and other features are also available.

For a complete rundown of the entire list of Boom! Box 6.5GT features, visit [www.H-D.com](http://www.H-D.com)

Fits '14-later Touring models with the Boom!™ Box 4.3 audio system.

<b>76000511</b>	Domestic.	<b>\$1,849.95</b>
<b>76000512</b>	Europe.	<b>\$1,849.95</b>
<b>76000232</b>	Rest of the world.	<b>\$1,800.00</b>

## B. BOOM! AUDIO SIRIUSXM® SATELLITE RADIO KIT

Don't lose the radio reception in the middle of your favorite song. SiriusXM Satellite Radio allows you to listen to the same channel as you cross the country. With over 200 digital channels, you'll always find a program that satisfies your taste for music, news, entertainment and sports. The module also provides a 25% increase in data transfer bandwidth to support weather, traffic and future data services. Your radio display provides information regarding artist name, song title and channel information so you will always know what program you are listening to. Channel presets allow you to quickly access your favorite programming. Activation and monthly subscription service required with additional fee.

**76000351** **\$399.95**  
Fits '14-later Touring and Tri Glide® models equipped with Boom! Box 6.5 audio system.

## C. BOOM! AUDIO MUSIC AND COMMUNICATIONS KIT

Add rider headphone-access to music and helmet microphone activation of voice recognition and hands-free phone features of the Boom! Box Radio. Plug-in wiring harness allows rider to connect a standard 7-pin DIN communications headset to the radio to maximize the use of the infotainment system's convenience features. Discrete tank port accepts 7-pin plugs for rider. Works with Boom!™ Audio full- and half-helmet music and communication headsets. Kit includes wiring harness, rider plug-in ports, weatherproof under seat port cover and all necessary mounting hardware.

**69200865** **\$69.95**  
Fits '14-later FLHX, FLHXS, FLTRX and FLTRXS models.  
Dealer Digital Technician® software update is required.

## D. BOOM! AUDIO BIKE-TO-BIKE COMMUNICATIONS KIT

Communicate with your friends on any of 40 channels. Easy to use handlebar controls allow Push-To-Talk (PTT) and adjustable squelch levels for maximum performance and reception quality. Integrated CB System will mute the radio while in transmit or receive mode. Bike-to-Bike system allows you and your passenger to talk with other riders, even when you are miles apart.

**76000486** **\$324.95**  
Fits '14-later FLHTCU and FLHTCUTG models with a Boom! Box audio system. Requires separate purchase of Shorty CB Antenna P/N 76386-09A or Whip Antenna 76250-09 and Mounting Stud P/N 76000166. Also requires Push-To-Talk Button in Switch Pack P/N 71500130.

### Model Family Fitment:

 V-ROD	 SPORTSTER	 DYNA
 SOFTAIL	 TOURING	

*Notice: The prices appearing in this catalog are the manufacturer's suggested retail prices. Actual retail prices may vary.*



**A. BOOM! BOX 6.5GT RADIO KIT – AM/FM/WB RADIO**



**A. BOOM! BOX 6.5GT RADIO KIT – GPS NAVIGATION**



**B. BOOM! AUDIO SIRIUSXM SATELLITE RADIO KIT**



**C. BOOM! AUDIO MUSIC AND COMMUNICATIONS KIT**



**D. BOOM! AUDIO BIKE-TO-BIKE COMMUNICATIONS KIT**



NEW

E. 3.5MM AUXILIARY INPUT KIT



NEW

## AUDIO & GAUGES 647

Boom!™ Audio – '14-'15 Touring

### E. 3.5MM AUXILIARY INPUT KIT

Add additional music and information source options to your Boom!™ Box-equipped Harley-Davidson® model. Harness enables GPS units, phones and music players equipped with a 3.5mm mini plug to feed their signal directly to the Boom! Box receiver. Harness length permits running cable to fairing-mounted Jukebox door or glove compartment or behind fairing to a GPS mount.

**69200907** **\$39.95**  
Fits '14-later Electra Glide®, Road Glide®, Street Glide® and Tri Glide® models.

### F. BOOM!™ AUDIO AMPLIFIER KIT

Take your music to the streets. Boom! Audio Amplifier Kits allow you to crank up the volume with significantly less distortion. The amplifier provides more power than Original Equipment radio alone, resulting in increased volume, fuller sound reproduction, reduced clipping and lower Total Harmonic Distortion (THD) than head unit alone. Unlike aftermarket amplifiers that connect between the radio and the speakers, the Boom! Audio amplifier bypasses the radio's internal power amp to produce the cleanest sound possible. The Boom! Audio Amplifier boosts the pure source signal, minimizing any distortion generated through the speaker output. The system-matched high-output signal features optimized sound equalization for crisp, clear vocals and maximum bass response and the strong midrange response cuts through wind and road noise. The waterproof 4-channel, 75-watts/channel amplifier (300-watt total) has been designed from the ground-up for the harsh motorcycle environment. Kit includes all mounting hardware and wiring harness. Note: The use of the Boom! Audio Amplifier turns off the radio's internal amplifier. Installation of a third or fourth set of speakers requires the Boom! Audio Speaker Expansion Kit.

**76000278** **\$599.95**  
Fits '14-later Electra Glide, Street Glide and Tri Glide models equipped with a Boom! Box audio system. Dealer Digital Technician software update is required. Dealer installation is recommended. Separate purchase of Fairing Power Extension Harness P/N 69200921 is required if installed with Boom! Audio Hidden AM/FM/WB Antenna P/N 76000513, Electra-Glo™ Headlamp Trim Rings or Fairing Edge Lights.

**76000523** **\$599.95**  
Fits '15-later FLTRX and FLTRXS models. Original Equipment on '15-later CVO™ Road Glide model. Dealer Digital Technician software update is required. Dealer installation is recommended. Separate purchase of Fairing Power Extension Harness P/N 69200921 is required if installed with Boom! Audio Hidden AM/FM/WB Antenna P/N 76000513, Electra-Glo™ Headlamp Trim Rings or Fairing Edge Lights.



F. BOOM! AUDIO AMPLIFIER KIT –  
(76000278 SHOWN)



NEW

F. BOOM! AUDIO AMPLIFIER KIT –  
(76000523 SHOWN)

### G. BOOM! AUDIO SPEAKER EXPANSION KIT

Add more Boom! to your bike. This kit permits the addition of a third or fourth pair of speakers to your Boom! Audio-equipped Touring bike. Choose a combination of Boom! Audio Fairing Lower Speakers and/or Rear Speaker Pods (sold separately) to build a sound system custom-designed to your audio demands. System also provides speaker fade capabilities between fairing and non-fairing mounted speakers for highway riding, when it's needed most. You can upgrade your system all at once or one set of speaker options at a time. Kit includes 75-watt/channel (300-watts total) saddlebag-mounted amplifier, amplifier cover, mounting bracket and the required installation hardware and wiring harness. Ensure maximum output of your audio system with the recommended High Output Charging System P/N 29900028. Note: The use of the Boom! Audio Amplifier turns off the radio's internal amplifier. Installation of a third or fourth set of speakers requires the Boom! Audio Speaker Expansion Kit.

**76000280** Saddlebag Mounted. **\$699.95**  
Fits '14-later Touring models equipped with a Boom! Box audio system. Required to add a 3rd or 4th set of speakers. Dealer Digital Technician software update is required. Dealer installation is recommended.



G. BOOM! AUDIO SPEAKER EXPANSION KIT

AUDIO & GAUGES

Notice: The prices appearing in this catalog are the manufacturer's suggested retail prices. Actual retail prices may vary.



## 648 AUDIO & GAUGES

Boom!™ Audio – '14-'15 Touring

### BOOM!™ AUDIO BAGGER AMP & SPEAKER KITS

Fill the air with sound from this Boom!™ Audio Boom Bagger Kit. Available to fit 2- and 4-speaker models, this complete audio kit provides the latest in Harley-Davidson® audio components. When installed, the increased power of the amplifier provides the speakers with a clean signal and a custom equalization is available to further optimize the performance of the Boom! Audio speaker system. Speakers feature two-year warranty. Dealer Digital Technician® software update is required. Dealer installation is recommended. Ensure maximum output of your audio system with the recommended High Output Charging System P/N 29900028. Note: The use of the Boom! Audio Amplifier turns off the radio's internal amplifier. Installation of a third or fourth set of speakers requires the Boom! Audio Speaker Expansion Kit.

#### A. 4-SPEAKER ULTRA BOOM! BAGGER KIT

Kit includes Boom! Audio 6.5" fairing and rear speakers, Boom! Audio 4-channel fairing-mounted amplifier, amplifier mount and wiring harness.

**76000411** **\$999.95**

Fits '14-later FLHTCU, FLHTCUL, FLHTK, FLHTKL and FLHTCUTG models. Also fits '14-later Street Glide® models equipped with King Tour-Pak® and rear speaker pods. Dealer Digital Technician software update is required. Dealer installation is recommended. Separate purchase of Fairing Power Extension Harness P/N 69200921 is required if installed with Boom! Audio Hidden AM/FM/WB Antenna P/N 76000513, Electra Glo™ Headlamp Trim or Fairing Edge Lights.

#### B. 2-SPEAKER STREET GLIDE® BOOM! BAGGER KIT

Kit includes Boom! Audio 6.5" fairing speakers, Boom! Audio 4-channel fairing-mounted amplifier, amplifier mount and wiring harness. Kit can easily be upgraded to a 4-speaker system with the addition of a Tour-Pak and Rear Speaker Enclosures or Fairing Lower and Fairing Lower Speakers.

**76000410** **\$799.95**

Fits '14-later FLHX and FLHXS models. Dealer Digital Technician software update is required. Dealer installation is recommended. Separate purchase of Fairing Power Extension Harness P/N 69200921 is required if installed with Boom! Audio Hidden AM/FM/WB Antenna P/N 76000513, Electra Glo Headlamp Trim or Fairing Edge Lights.

#### C. 2-SPEAKER ROAD GLIDE® BOOM! BAGGER KIT

Kit includes Boom! Audio 6.5" fairing speakers, Boom! Audio 4-channel fairing-mounted amplifier, amplifier mount and wiring harness. Kit can easily be upgraded to a 4-speaker system with the addition of Saddlebag Lid Speakers, Fairing Lower Speakers or a Tour-Pak and Rear Speaker Enclosures.

**76000587** **\$829.95**

Fits '15-later FLTRX and FLTRXS models. Dealer Digital Technician software update is required. Dealer installation is recommended. Separate purchase of Fairing Power Extension Harness P/N 69200921 is required if installed with Boom! Audio Hidden AM/FM/WB Antenna P/N 76000513, Electra Glo Headlamp Trim or Fairing Edge Lights.



A. BOOM! AUDIO BAGGER AMP & SPEAKER KIT – ULTRA 4-SPEAKER KIT



B. BOOM! AUDIO BAGGER AMP & SPEAKER KIT – STREET GLIDE 2-SPEAKER KIT



C. BOOM! AUDIO BAGGER AMP & SPEAKER KIT – ROAD GLIDE 2-SPEAKER KIT

Notice: The prices appearing in this catalog are the manufacturer's suggested retail prices. Actual retail prices may vary.

# AUDIO & GAUGES 649

Boom!™ Audio – '14-'15 Touring



**D. BOOM! AUDIO HIGH PERFORMANCE 6.5" SPEAKERS – BATWING FAIRING**



**D. BOOM!™ AUDIO HIGH PERFORMANCE SPEAKERS – 6.5"**

Make the whole world sing. Boom!™ Audio Speakers are designed to maximize music volume and clarity in the harsh motorcycle environment. The full-range two-way speakers feature high strength, larger than stock polypropylene 6.5" cones for improved low and mid frequencies and bridge-mounted damped soft-dome 1.0" tweeters for improved high frequencies. Composite frame and high-performance magnet increase the speaker's power-handling capabilities. The weather and vibration resistant speakers are protected behind perforated metal grills and are sized as a direct replacement for the Original Equipment sound system. Complete kit includes 2 two-way speakers, electronic crossovers, metal grills and plug-in wiring connection. Speakers feature two-year warranty.

**76000317** 6.5" Batwing Fairing Speakers. **\$199.95**  
Fits '14-later FLHTCU, FLHTCUL, FLHTK, FLHTKL, FLHTCUTG, FLHX and FLHXS models.

**76000548** 6.5" Road Glide® Fairing Speakers. **\$229.95**  
Fits '15-later Road Glide models. Original Equipment on '15-later CVO™ Road Glide.

**76000318** 6.5" Tour-Pak® Rear Speakers. **\$199.95**  
Fits '14-later FLHTCU, FLHTCUL, FLHTCUTG, FLHTK and FLHTKL models. Also fits FLHX, FLHXS, FLTRX and FLTRXS models equipped with a King Tour-Pak and Boom! Audio Rear Speaker Enclosure Kit.

**E. TOUR-PAK® REAR SPEAKER ENCLOSURE KIT**

Add concert-hall sound to your motorcycle. Tour-Pak Rear Speaker Enclosures enable the installation of Boom! Audio 6.5" Rear Speakers on Street Glide® and Road Glide models equipped with King Tour-Pak luggage. Enclosure Kit includes rear speaker pods and wiring harness for speaker hook-up. Boom! Audio Tour-Pak 6.5" Rear Speaker Kit P/N 76000318 is sold separately.

**76000505** **\$249.95**  
Fits '14-later FLHX, FLHXS, FLTRX and FLTRXS models equipped with King Tour-Pak luggage.



**D. BOOM! AUDIO HIGH PERFORMANCE 6.5" SPEAKERS – ROAD GLIDE FAIRING**



**D. BOOM! AUDIO HIGH PERFORMANCE 6.5" SPEAKERS – TOUR-PAK**



**E. TOUR-PAK REAR SPEAKER ENCLOSURE KIT**

**Model Family Fitment:**

- V-ROD
- SPORTSTER
- DYNA
- SOFTAIL
- TOURING

*Notice: The prices appearing in this catalog are the manufacturer's suggested retail prices. Actual retail prices may vary.*



# 650 AUDIO & GAUGES

Boom!™ Audio – '14-'15 Touring

## A. BOOM!™ AUDIO FAIRING LOWER SPEAKER KIT

Boom!™ Audio Fairing Lower Speakers provide two additional sound sources directed at the rider for a concert-hall sound experience. Adding fairing lower speakers to your current two-speaker system increases the available sound pressure level, permitting higher listening volume, lower distortion and improved clarity at highway speeds. The pair of 6.5" waterproof 2-ohm full range speakers feature suspended 1.0" soft-dome tweeters that are directionally optimized for improved rider acoustics. A molded tray fits tightly into the fairing lower and forms a sound-optimized ported speaker enclosure for improved bass performance. The speakers mount to the fairing lowers with color-matched speaker boxes (sold separately). Kit includes left and right speakers, perforated metal speaker grills, ported lower tray and installation hardware. Fairing lowers sold separately. Speakers feature two-year warranty.

**76000487** **\$279.95**

Fits '14-later FLHTCU, FLHTCUL, FLHX, FLHXS, FLTRX and FLTRXS models equipped with vented fairing lowers. Does not fit models equipped with Twin-Cooled™ engine.



A. BOOM! AUDIO FAIRING LOWER SPEAKER KIT

## B. BOOM! AUDIO SADDLEBAG SPEAKER KIT

Boom! Audio Saddlebag Speakers increase the available sound pressure level (SPL) and produce higher listening volume, lower distortion and improved clarity at highway speeds. The pair of 5" x 7" waterproof 2-ohm full range speakers feature high strength woofer cones and suspended 25mm tweeters that are directionally optimized for improved rider acoustics. Extensively tested to withstand the harshest riding conditions, the speakers fit seamlessly in custom-designed saddlebag lids (sold separately) and are covered by stylish and durable perforated metal speaker grills. Kit includes left and right speakers, grills, rear wiring harness and installation hardware. Color-matched saddlebag lids sold separately. Speakers feature two-year warranty.

**76000489** **\$399.95**

Fits '14-later FLHTCU, FLHTCUL, FLHTK, FLHTKL, FLHX, FLHXS, FLTRX and FLTRXS models. Requires separate purchase of appropriate Saddlebag Lids. Dealer Digital Technician software update is required. Dealer installation is recommended.



B. BOOM! AUDIO SADDLEBAG SPEAKER KIT

## C. COLOR-MATCHED FAIRING LOWER SPEAKER BOXES

Speaker boxes replace the Original Equipment glove boxes and direct the sound toward the rider and passenger. Kit includes left and right speaker box and required hardware.

Fits '14-later Touring models equipped with vented fairing lowers and Boom! Audio Fairing Lower Speaker Kit P/N 76000487. Does not fit models with Twin-Cooled engines.

See page 808 for complete list of available Color-Matched options.



C. COLOR-MATCHED FAIRING LOWER SPEAKER BOXES

## D. COLOR-MATCHED SADDLEBAG SPEAKER LIDS

Custom saddlebag lids are shaped to accommodate Boom! Audio Saddlebag Lid Speakers. Speaker openings are formed to angle the speakers and direct the sound forward toward the rider and passenger. Kit reuses Original Equipment hinges, locks and mounting hardware.

Fits '14-later Touring models equipped with Boom! Audio Saddlebag Speaker Kit P/N 76000489.

See page 808 for complete list of available Color-Matched options.



D. COLOR-MATCHED SADDLEBAG SPEAKER LIDS

### Model Family Fitment:

- V-ROD
- SPORTSTER
- DYNA
- SOFTAIL
- TOURING

Notice: The prices appearing in this catalog are the manufacturer's suggested retail prices. Actual retail prices may vary.

# THE CHOICE IS CLEAR

Harley-Davidson® Boom!™ Audio is an exciting collection of integrated audio components designed to combine the maximum number of features with an easy-to-use interface. And because your bike's Advanced Audio Radio is designed for plug-and-play integration of Boom! Audio equipment, you can easily create the custom sound experience you've always wanted.



### IPOD® INTERFACE

Access your iPod® playlists, artists, songs and albums while you keep your hands on the handlebar. At the touch of your fingertips, you can use the factory audio hand controls to scan through the iPod menus and view the selections on the radio face.



### FAIRING LOWER SPEAKERS

Nestled into the glove boxes of your vented fairing lowers, these vibration-tested waterproof two-way speakers feature rider directed tweeters for clear, crisp sound.

### SADDLEBAG LID SPEAKERS

Directionally optimized for improved rider acoustics, these waterproof 5" x 7" two-way speakers turn the latched and gasket-sealed saddlebags into large speaker enclosures for enhanced bass response.



### AMPLIFIERS

When loud just isn't loud enough. Rugged Fairing, Tour-Pak® and Saddlebag-mounted amplifiers provide increased volume, lower distortion, reduced clipping and fuller sound that cuts through wind and road noise.



### FAIRING SPEAKERS

Capture every note. Designed for maximum performance in the harsh motorcycle environment, these waterproof two-way speakers feature increased sensitivity for 25% louder output, reduced distortion and improved clarity at speed.



### TOUR-PAK® SPEAKER PODS

Surround yourself with sound. Forward-facing two-way speakers feature waterproof grill-mounted tweeters and injection-molded woofer cones with high-flux Neodymium magnets and are sized to be a direct replacement for the factory speakers.



### BASS BOOST PORTS

Boost bass response without adding a subwoofer. The open ports permit the rear speaker pods to "breathe," using the Tour-Pak air space for a 21% increase in bass response and an 82% reduction in distortion.

2013 STREET GLIDE® SHOWN



# 652 AUDIO & GAUGES

Boom!™ Audio – '06-'13 Touring

## BOOM!™ AUDIO PREMIUM SOUND OPTIONS

The Boom!™ Audio system is an exciting collection of audio and information components that turn your 2006 – 2013 Touring motorcycle into a rolling “infotainment” center. Designed for ease of use, this line of premium speakers, amplifiers and audio upgrades integrate with the factory-installed radio and hand controls for seamless operation.

See the table below to view the Boom! Audio options. Your Dealer will be happy to recommend system-matched components for your model and provide the installation expertise that your Harley® motorcycle deserves.



For the latest information, visit [h-d.com/boomaudio](http://h-d.com/boomaudio).

### '06-'13 ELECTRA GLIDE®/STREET GLIDE® MODELS

Part Number	Description	FLHT (with Radio)	FLHT (with Radio & Tour-Pak)	FLHX	FLHX (with Tour-Pak)	FLHTC	FLHTCU	FLHTK
76000070	Amplifier, Fairing Mount (Batwing)	69200106	NO FIT	69200106	NO FIT	NO FIT	N/A	N/A
76000169	Amplifier, Fairing Mount (Road Glide®)	NO FIT	NO FIT	NO FIT	NO FIT	NO FIT	NO FIT	NO FIT
76000068	Amplifier, Tour-Pak® Mount	N/A	70169-06A	N/A	70169-06A	70169-06A	OK	OK
76000209	Custom Touring Audio System	OK	NO FIT	OK	NO FIT	NO FIT	NO FIT	NO FIT
76000051	Ultra Boom! Bagger Kit	N/A	70169-06A	N/A	70169-06A	70169-06A	OK	OK
76000074	Street Glide® Boom! Bagger Kit	69200106	NO FIT	69200106	NO FIT	NO FIT	N/A	N/A
76000050	Fairing Lower Speakers	69200106	69200106	69200106	69200106	69200106	76000263	76000263
76000021	Rear Speaker Pods	N/A	69200106	N/A	69200106	69200106	STOCK	STOCK
76000202	Saddlebag Lid Speakers	69200106	69200106	69200106	69200106	69200106	76000263	76000263
76000263	Speaker Expansion Kit	OK	OK	OK	OK	OK	OK	OK
76000275	CVO™ Speaker Expansion Kit	NO FIT	NO FIT	NO FIT	NO FIT	NO FIT	NO FIT	NO FIT
76476-10	iPod® Interface Kit	69200033	69200033	69200033	69200033	69200033	OK	OK
76000024	Navigation Interface Module	69200033	69200033	69200033	69200033	69200033	OK	OK
76404-06	SiriusXM® Satellite Radio Kit	70169-06A	70169-06A	70169-06A	70169-06A	70169-06A	70172-06	70172-06
77173-08	Audio Communication Switch Kit	70169-06A	70169-06A	70169-06A	70169-06A	70169-06A	STOCK	STOCK
76000390	B2B Communication Kit	70169-06A	70169-06A	70169-06A	70169-06A	70169-06A	STOCK	STOCK
77107-09	Music & Intercom Kit	OK	OK	OK	OK	OK	N/A	N/A
77108-09	Music & Intercom Kit (B2B Feature)	70169-06A	70169-06A	70169-06A	70169-06A	70169-06A	N/A	N/A
76440-06	Music & Intercom Kit (Tour-Pak)	N/A	70169-06A	N/A	70169-06A	70169-06A	STOCK	STOCK

### '06-'13 ROAD GLIDE® MODELS

### '09-'13 TRIKE

Part Number	Description	FLTR	FLTR (with Tour-Pak)	FLTRX	FLTRX (with Tour-Pak)	FLTRU	FLHXXX	FLHTCUTG
76000070	Amplifier, Fairing Mount (Batwing)	NO FIT	NO FIT	NO FIT	NO FIT	NO FIT	69200106	N/A
76000169	Amplifier, Fairing Mount (Road Glide)	69200106	69200106	69200106	69200106	OK	NO FIT	NO FIT
76000068	Amplifier, Tour-Pak Mount	N/A	70169-06A	N/A	70169-06A	OK	N/A	OK
76000209	Custom Touring Audio System	NO FIT	NO FIT	NO FIT	NO FIT	NO FIT	NO FIT	NO FIT
76000051	Ultra Boom! Bagger Kit	N/A	70169-06A	N/A	70169-06A	OK	N/A	OK
76000074	Street Glide Boom! Bagger Kit	NO FIT	NO FIT	NO FIT	NO FIT	NO FIT	69200106	N/A
76000050	Fairing Lower Speakers	NO FIT	69200106	69200106	69200106	76000263	69200106	76000263
76000021	Rear Speaker Pods	N/A	69200106	N/A	69200106	STOCK	N/A	STOCK
76000202	Saddlebag Lid Speakers	69200106	69200106	69200106	69200106	76000263	NO FIT	NO FIT
76000263	Speaker Expansion Kit	OK	NO FIT	OK	OK	OK	OK	OK
76000275	CVO Speaker Expansion Kit	NO FIT	NO FIT	NO FIT	NO FIT	NO FIT	NO FIT	NO FIT
76476-10	iPod Interface Kit	69200033	69200033	69200033	69200033	OK	69200033	OK
76000024	Navigation Interface Module	69200033	69200033	69200033	69200033	OK	69200033	OK
76404-06	SiriusXM Satellite Radio Kit	70169-06A	70169-06A	70169-06A	70169-06A	70172-06	70169-06A	70172-06
77173-08	Audio Communication Switch Kit	70169-06A	70169-06A	NO FIT	NO FIT	STOCK	70169-06A	STOCK
76000390	B2B Communication Kit	70169-06A	70169-06A	NO FIT	70169-06A	STOCK	NO FIT	STOCK
77107-09	Music & Intercom Kit	OK	OK	NO FIT	NO FIT	N/A	OK	N/A
77108-09	Music & Intercom Kit (B2B Feature)	70169-06A	70169-06A	NO FIT	NO FIT	N/A	70169-06A	N/A
76440-06	Music & Intercom Kit (Tour-Pak)	N/A	70169-06A	N/A	70169-06A	STOCK	N/A	STOCK

## CVO™ STREET GLIDE®

## CVO ELECTRA GLIDE® ULTRA

Part Number	Description	CVO 2010 FLHXSE	CVO 2011 FLHXSE2	CVO 2012 FLHXSE3	CVO '06-'10 FLHTCUSE	CVO 2011 FLHTCUSE6	CVO 2012 FLHTCUSE7	CVO 2013 FLHTCUSE8
76000070	Amplifier, Fairing Mount (Batwing)	69200106	NO FIT	NO FIT	N/A	NO FIT	NO FIT	NO FIT
76000169	Amplifier, Fairing Mount (Road Glide®)	NO FIT	NO FIT	NO FIT	NO FIT	NO FIT	NO FIT	NO FIT
76000068	Amplifier, Tour-Pak® Mount	N/A	NO FIT	NO FIT	STOCK	STOCK	STOCK	STOCK
76000209	Custom Touring Audio System	OK	NO FIT	STOCK	NO FIT	NO FIT	NO FIT	NO FIT
76000051	Ultra Boom!™ Bagger Kit	N/A	NO FIT	NO FIT	N/A	N/A	STOCK	STOCK
76000074	Street Glide® Boom! Bagger Kit	69200106	NO FIT	NO FIT	N/A	NO FIT	NO FIT	NO FIT
76000050	Fairing Lower Speakers	69200106	N/A	N/A	76000263	76000263	76000263	76000263
76000021	Rear Speaker Pods	N/A	NO FIT	NO FIT	N/A	N/A	STOCK	STOCK
76000202	Saddlebag Lid Speakers	69200106	NO FIT	N/A	76000263	76000263	76000263	76000263
76000263	Speaker Expansion Kit	OK	NO FIT	NO FIT	OK	OK	OK	OK
76000275	CVO™ Speaker Expansion Kit	NO FIT	OK	STOCK	NO FIT	NO FIT	NO FIT	NO FIT
76476-10	iPod® Interface Kit	69200033	STOCK	STOCK	OK	NO FIT	STOCK	STOCK
76000024	Navigation Interface Module	69200033	76000275	NO FIT	OK	NO FIT	STOCK	STOCK
76404-06	SiriusXM® Satellite Radio Kit	70169-06A	76000275	NO FIT	STOCK	STOCK	STOCK	STOCK
77173-08	Audio Communication Switch Kit	70169-06A	NO FIT	NO FIT	STOCK	STOCK	STOCK	STOCK
76000390	B2B Communication Kit	70169-06A	NO FIT	NO FIT	STOCK	STOCK	STOCK	STOCK
77107-09	Music & Intercom Kit	OK	NO FIT	NO FIT	STOCK	NO FIT	NO FIT	NO FIT
77108-09	Music & Intercom Kit (B2B Feature)	70169-06A	NO FIT	NO FIT	STOCK	NO FIT	NO FIT	NO FIT
76440-06	Music & Intercom Kit (Tour-Pak)	N/A	NO FIT	NO FIT	STOCK	STOCK	STOCK	STOCK

**AUDIO & GAUGES**

## CVO ROAD GLIDE®

## CVO ROAD KING®

Part Number	Description	CVO 2009 FLTRSE	CVO 2011 FLTRUSE	CVO 2012 FLTRXSE	CVO 2013 FLTRXSE2	CVO 2013 FLHRSE5
76000070	Amplifier, Fairing Mount (Batwing)	69200106	NO FIT	NO FIT	NO FIT	NO FIT
76000169	Amplifier, Fairing Mount (Road Glide)	NO FIT	NO FIT	NO FIT	NO FIT	NO FIT
76000068	Amplifier, Tour-Pak Mount	N/A	STOCK	NO FIT	NO FIT	NO FIT
76000209	Custom Touring Audio System	NO FIT	NO FIT	NO FIT	STOCK	NO FIT
76000051	Ultra Boom! Bagger Kit	N/A	N/A	NO FIT	NO FIT	NO FIT
76000074	Street Glide Boom! Bagger Kit	69200106	NO FIT	NO FIT	NO FIT	NO FIT
76000050	Fairing Lower Speakers	69200106	76000263	N/A	N/A	N/A
76000021	Rear Speaker Pods	N/A	STOCK	NO FIT	NO FIT	NO FIT
76000202	Saddlebag Lid Speakers	69200106	76000263	N/A	N/A	N/A
76000263	Speaker Expansion Kit	OK	OK	NO FIT	NO FIT	NO FIT
76000275	CVO Speaker Expansion Kit	NO FIT	NO FIT	OK	STOCK	NO FIT
76476-10	iPod Interface Kit	69200033	STOCK	STOCK	STOCK	NO FIT
76000024	Navigation Interface Module	69200033	STOCK	76000275	NO FIT	NO FIT
76404-06	SiriusXM Satellite Radio Kit	70169-06A	STOCK	76000275	NO FIT	NO FIT
77173-08	Audio Communication Switch Kit	70169-06A	STOCK	NO FIT	NO FIT	NO FIT
76000390	B2B Communication Kit	70169-06A	STOCK	NO FIT	NO FIT	NO FIT
77107-09	Music & Intercom Kit	OK	NO FIT	NO FIT	NO FIT	NO FIT
77108-09	Music & Intercom Kit (B2B Feature)	70169-06A	NO FIT	NO FIT	NO FIT	NO FIT
76440-06	Music & Intercom Kit (Tour-Pak)	N/A	STOCK	NO FIT	NO FIT	NO FIT

### KEY

N/A	Not applicable. Stock or requires substitution or separate purchase.
OK	Ready to install. No additional harness purchase required.
NO FIT	Will not fit. Not for use with model.
70169-06A	Harness required. Permits multiple audio accessory combinations and allows any or all of the following: SiriusXM, Bike-to-Bike Communications, additional speakers, Tour-Pak amplifier, iPod Interface, Navigation Interface, headsets and Communications Kit.
69200106	Harness required. Permits installation of Fairing Amplifier and additional speakers (Fairing Lower, Saddlebag Lid or Tour-Pak Pod speakers). Also allows installation of iPod Interface and/or Navigation Interface. **If installing any other audio accessories in addition to those listed above with Tour-Pak Amplifier, use Harness P/N 70169-06A. See matrix for details.
69200033	Harness required. Permits installation of iPod Interface and/or Navigation Interface ONLY on models not previously equipped with other Audio Accessories. *If installing additional audio accessories with iPod Interface and/or Navigation Interface, use Harness P/N 70169-06A or 69200106. See matrix for details.
70172-06	Harness required. Permits installation of SiriusXM module ONLY on FLHTCU, FLHTK and FLTRU models. Uses CB connector.
76000263	Speaker Expansion Kit required. Permits installation of 3rd and 4th pair of speakers.
76000275	CVO Speaker Expansion Kit required. Permits installation of SiriusXM module and/or Navigation Interface on specified CVO models.



# 654 AUDIO & GAUGES

Boom!™ Audio – '06-'13 Touring

## A. ADVANCED AUDIO AM/FM/CD RADIO KIT BY HARMAN/KARDON®

Upgrade your Electra Glide® Standard model to the latest in mobile communications technology. The Advanced Audio Radio is the first step to a total entertainment experience. Compatible with other Advanced Audio accessories, the radio features a menu-driven display that provides easy access to the many standard and available features. The radio features 6 AM and 10 FM radio presets, integrated weather band with weather alert warnings and a single disc CD player that is compatible with CD/CDR/CDRW and MP3 format discs. MP3 compression technology allows each CD to hold up to 10 hours of music. The two fairing-mount speakers (included) are powered by a 20-watt per channel internal amplifier and the Automatic Volume Control adjusts the volume to compensate for motorcycle speed. The complete Advanced Audio Radio Kit includes everything your dealer needs to install the AM/FM/WB/CD unit in the fairing of a 2006-2010 Electra Glide Standard model. Dealer Digital Technician® software update is required. Dealer installation is recommended.

**76412-06 \$999.95**

Fits '06-'10 Electra Glide Standard models. '06-'08 models require Hidden Antenna P/N 76000266. '09 models require Antenna Frame Mount Kit P/N 76556-09 and separate purchase of antenna. '06-later models with Tour-Pak® require Tour-Pak Antenna Kit P/N 76251-98A.



**A. ADVANCED AUDIO AM/FM/CD RADIO KIT BY HARMAN/KARDON**

## B. BOOM!™ AUDIO AMPLIFIER KITS

Take your music to the streets. Boom!™ Audio Amplifier Kits allow you to crank up the volume with significantly less distortion. The amplifier provides more power than Original Equipment radio alone, resulting in increased volume, fuller sound reproduction, reduced clipping and lower Total Harmonic Distortion (THD) than head unit alone. When teamed with Boom! Audio Speakers, the Boom! Amplifier provides 50% louder (6dB) system output than other popular aftermarket systems at the same volume setting. The system-matched high-output signal features optimized sound equalization for crisp, clear vocals and maximum bass response and the strong midrange response cuts through wind and road noise. The amplifier features 40-watt/channel (160-watt total) output. Kit includes all mounting hardware.

**76000070 Fairing Amp. \$409.95**

Fits '06-'13 FLHX (except FLHXSE2/3) and '06-'09 FLHT models. Not for use with Boom! Audio SiriusXM® Satellite Radio Kit P/N 76404-06, Boom! Audio Bike-to-Bike Communication Kit P/N 76416-06C or Tour-Pak luggage. Requires separate purchase of appropriate Wiring Harness. Models equipped with Boom! Audio iPod® Interface P/N 76476-10 require separate purchase of iPod Relocation Kit P/N 76000238. Dealer Digital Technician software update is required. Dealer installation is recommended.

**76000169 Fairing Amp. (not shown) \$409.95**

Fits '06-'13 Road Glide® models (except FLTRXSE/2 and FLTRUSE/2). All models (except FLTRU) require separate purchase of appropriate Wiring Harness. Dealer Digital Technician software update is required. Dealer installation is recommended.

**76000068 Tour-Pak Amp. \$409.95**

Fits '06-'13 Touring models (except FLHXSE2/3 and FLTRXSE/2) equipped with an Advanced Audio Radio and rigid-mount Tour-Pak luggage system. Requires installation of appropriate Wiring Harness. Dealer Digital Technician software update is required. Dealer installation is recommended.



**A. ADVANCED AUDIO AM/FM/CD RADIO KIT BY HARMAN/KARDON**



**B. BOOM! AUDIO FAIRING MOUNT AMPLIFIER – ELECTRA GLIDE – (76000070 SHOWN)**



**B. BOOM! AUDIO FAIRING MOUNT AMPLIFIER**



**B. BOOM! AUDIO FAIRING MOUNT AMPLIFIER**

### Model Family Fitment:

- V-ROD
- SPORTSTER
- DYNA
- SOFTAIL
- TOURING

*Notice: The prices appearing in this catalog are the manufacturer's suggested retail prices. Actual retail prices may vary.*

## AUDIO & GAUGES 655

Boom!™ Audio – '06-'13 Touring



C. BOOM! AUDIO IPOD INTERFACE

### C. BOOM!™ AUDIO IPOD® INTERFACE

Available exclusively for models equipped with the Harley-Davidson® Advanced Audio System by Harman/Kardon®. The Boom!™ Audio iPod® interface allows you to access your iPod playlists, artists, songs and albums while you keep your hands on the handlebar. At the touch of your fingertips, you can use the factory audio hand controls to scan through the iPod menus and view the selections on the radio face. The module mounts directly to the radio and is concealed inside the fairing for a clean look. Just plug in your iPod nano®, iPod Touch® or iPhone® and hit the road. Kit includes a powered iPod cable that charges your player when it is connected to the system and the bike is turned on. The iPod can be remotely stored in the saddlebag with the separate purchase of Boom! Audio Saddlebag iPod Holder P/N 76000143.

**76476-10 \$399.95**  
Fits '06-'13 FLHT, FLHTC, FLHTCU, FLHTK, FLHTCUTG, FLHX, FLHXXX, FLTR, FLTRX and FLTRU models equipped with an Advanced Audio radio. Stock on select CVO™ models. Does not fit '11 CVO FLHTCUSE6. '06-later FLHX, FLTR, FLTRX and FLHTC models and those not equipped with Wiring Harness P/N 70169-06 require the separate purchase of Connector Kit P/N 69200033. Models equipped with Boom! Audio Fairing Amplifier require installation of iPod Relocation Kit P/N 76000238.



D. BOOM! AUDIO SIRIUSXM SATELLITE RADIO KIT

### D. BOOM! AUDIO SIRIUSXM® SATELLITE RADIO KIT\*

Don't lose the radio reception in the middle of your favorite song. SiriusXM® Satellite Radio allows you to listen to the same channel as you cross the country. With over 170 digital channels, you'll always find a program that satisfies your taste for music, news, entertainment and sports. Your radio display provides information regarding artist name, song title and channel information so you will always know what program you are listening to. 15 channel presets allow you to quickly access your favorite programming. Activation and monthly subscription service required with additional fee. For a limited time, your first three months of service are free.

**76404-06 \$499.95**  
Fits '06-'13 Touring models (except FLHXSE3 and FLTRXSE2) equipped with an Advanced Audio Radio. FLHXSE2 and FLTRXSE models require separate purchase of CVO Speaker Expansion Kit P/N 76000275. Requires installation of appropriate Wiring Harness and Antenna Bracket P/N 76456-06 (FLH models) or 76316-06A (FLTR models).

### E. BOOM! AUDIO SADDLEBAG IPOD HOLDER

Protect your iPod from the elements and keep it out of sight. Designed to complement Boom! Audio iPod Interface-equipped models, this saddlebag-mounted iPod Holder replaces the Original Equipment saddlebag tether and suspends your iPod in a shock-reducing zippered pouch. Just route your iPod Interface Cable to the saddlebag, plug in your iPod and forget about it. You control the operation with the fingertip controls on your Advanced-Audio Radio.

**76000143 \$149.95**  
Fits '06-'13 Touring models equipped with Color-Matched Hard Saddlebags and the Boom! Audio iPod Interface P/N 76476-10. Stock on select CVO models.



E. BOOM! AUDIO SADDLEBAG IPOD HOLDER



F. IPOD RELOCATION KIT

### F. IPOD RELOCATION KIT

Create room inside your fairing for a Boom! Audio Amplifier or additional Advanced Audio radio modules by relocating the iPod Interface Module to the saddlebag. Kit includes saddlebag mounting bracket, module cover and all necessary wiring.

**76000238 \$229.95**  
Fits '06-'13 FLHT, FLHTC, FLHTCU, FLHTK, FLHX, FLTR, FLTRX and FLTRU models equipped with Boom! Audio iPod Interface P/N 76476-10 and a Boom! Audio Fairing Amplifier. Does not fit '12-later CVO models or FLHTCUSE6.

\*See SiriusXM TERMS & CONDITIONS PAGE 666

Notice: The prices appearing in this catalog are the manufacturer's suggested retail prices. Actual retail prices may vary.



# 656 AUDIO & GAUGES

Boom!™ Audio – '06-'13 Touring

## BOOM!™ AUDIO BOOM! BAGGER AMP & SPEAKER KITS

- Boom!™ Bagger system offers an increase in frequency response range of 12% over the popular aftermarket upgrade amplifier and speaker system and 80% over the Stock system
- Boom! Bagger system distortion is 57% lower than popular aftermarket system providing increased clarity
- Boom! Bagger system output is >50% louder (6dB) than popular aftermarket system at the same volume setting
- Strong midrange response cuts through wind and road noise
- Extended bass response for accurate, full music reproduction

Fill the air with sound from this Boom! Audio Ultra Boom! Bagger Kit. Available to fit 2- and 4-speaker equipped Electra Glide® models, this complete audio kit provides the latest in Harley-Davidson® audio components. When installed, the increased power of the amplifier provides the speakers with a clean signal and a custom equalization is available to further optimize the performance of the Boom! Audio speakers. Speakers feature two-year warranty. Dealer Digital Technician® software update is required. Dealer installation is recommended.



A. BOOM! AUDIO BOOM! BAGGER KIT – ULTRA 4-SPEAKER KIT

## A. 4-SPEAKER ULTRA BOOM! BAGGER KIT

Kit includes Boom! Audio fairing and rear speakers, the Bass Booster Port Kit and the Boom! Audio Tour-Pak®-mounted Amplifier.

**76000051** **\$799.95**

Fits '06-'13 FLHTCU, FLHTK and FLHTCUTG models equipped with the Advanced Audio Radio. Also fits Electra Glide and Street Glide® models equipped with Advanced Audio Radio, rigid-mount King Tour-Pak and rear speaker pods.

## B. 2-SPEAKER STREET GLIDE® BOOM! BAGGER KIT

Kit includes Boom! Audio fairing speakers and Boom! Audio Fairing Mount Amplifier.

**76000074** **\$579.95**

Fits '06-'13 FLHX (except FLHXSE2/3) and '06-'09 FLHT models. Not for use with Boom! SiriusXM® Satellite Radio Kit P/N 76404-06, Boom! Audio Bike-to-Bike Communication Kit P/N 76416-06C or Tour-Pak luggage. Requires separate purchase of appropriate Wiring Harness. Models equipped with Boom! Audio iPod® Interface P/N 76476-10 require separate purchase of iPod Relocation Kit P/N 76000238.



B. BOOM! AUDIO BOOM! BAGGER KIT – STREET GLIDE 2-SPEAKER KIT

## C. BOOM! AUDIO SPEAKER EXPANSION KIT

Add more Boom! to your bike. This kit permits the addition of a third and fourth pair of speakers to your Boom! Audio-equipped Touring bike. Choose a combination of Boom! Audio Saddlebag Lid Speakers, Fairing Lower Speakers and/or Rear Speaker Pods (sold separately) to build a sound system custom-designed to your audio demands. System also provides speaker fade capabilities between fairing and non-fairing mounted speakers for highway riding, when it's needed most. You can upgrade your system all at once or one set of speaker options at a time. Kit includes 100-watt/channel (200-watts total) saddlebag-mounted amplifier, amplifier cover, mounting bracket and the required installation hardware and wiring harness.

**76000263** **\$569.95**

Fits '06-'13 Touring and Trike models (except '11-later FLHXSE2/3, FLTRXSE/2) equipped with Advanced Audio Radio and Boom! Audio Fairing Amplifier P/N 76000070, 76000074, 76000169 or Tour-Pak Amplifier P/N 76000068. Not for use with Custom Touring System P/N 76000209. Dealer Digital Technician software update is required. Dealer installation is recommended.

NOTE: Follow fitment statements for Boom! Audio Amplifiers listed above. Fairing-Mounted Amplifiers are not for use with Tour-Pak Luggage.



C. BOOM! AUDIO SPEAKER EXPANSION KIT

Notice: The prices appearing in this catalog are the manufacturer's suggested retail prices. Actual retail prices may vary.

# AUDIO & GAUGES 657

Boom!™ Audio – '06-'13 Touring

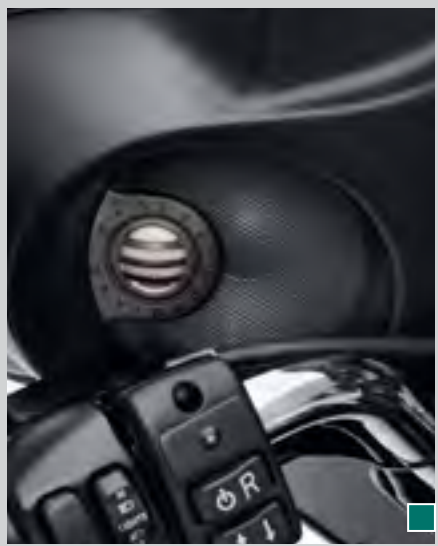

**D. BOOM! AUDIO HIGH PERFORMANCE BOOM! BAGGER FAIRING SPEAKERS – (ELECTRA GLIDE SHOWN)**



**D. BOOM! AUDIO HIGH PERFORMANCE BOOM! BAGGER FAIRING SPEAKERS – (ROAD GLIDE SHOWN)**



**D. BOOM! AUDIO HIGH PERFORMANCE BOOM! BAGGER REAR SPEAKERS**

**D. BOOM!™ AUDIO HIGH PERFORMANCE BOOM! BAGGER SPEAKERS\***

Capture every note. Boom!™ Bagger High Performance Speakers are designed for maximum performance in the harsh motorcycle environment. Two-way speaker design with separate full-range element and grill-mounted tweeter provides improved high-frequency response that helps cut through the road and wind noise. Increased speaker sensitivity provides louder output than Original Equipment speakers and the leading competition at the same volume setting, resulting in reduced distortion for improved clarity at speed. Vibration-tested 5.25" waterproof speakers feature injection-molded woofer cones with a high-flux Neodymium magnet and are sized to be a direct replacement for the factory speakers with no modification to the speaker housing. Complete kit includes two-way speaker design with separate custom grill-mounted tweeters, electronic crossovers and plug and play wiring connections. Speakers feature two-year warranty.

**Electra Glide® Fairing Speakers**

**77181-10** 2 ohm. **\$169.95**

Fits '06-'13 Street Glide®, Electra Glide® and Trike models equipped with fairing mount speakers and Advanced Audio System radio.

**76000256** 8 ohm. **\$169.95**

Fits '98-'05 Electra Glide models equipped with fairing mount speakers and Original Equipment radio.

**Road Glide® Fairing Speakers**

**77028-10** 2 ohm. **\$169.95**

Fits '06-'13 Road Glide® models equipped fairing mount speakers and Advanced Audio System radio.

**Tour-Pak® Rear Speakers**

**77037-10** 2 ohm. **\$169.95**

Fits '06-'13 Touring models (except CVO™) equipped with Tour-Pak® mounted speakers and Advanced Audio System radio.

**76000257** 8 ohm. **\$169.95**

Fits '98-'05 Touring models equipped with Tour-Pak mounted speakers and Original Equipment radio.

**Model Family Fitment:**

- V-ROD
- SPORTSTER
- DYNA
- SOFTAIL
- TOURING

*Notice: The prices appearing in this catalog are the manufacturer's suggested retail prices. Actual retail prices may vary.*



## 658 AUDIO & GAUGES

Boom!™ Audio – '06-'13 Touring

### A. BOOM!™ AUDIO FAIRING LOWER SPEAKER KIT\*

Drive through a wall of sound. Boom!™ Audio Fairing Lower Speakers provide two additional sound sources directed at the rider for a concert-hall sound experience. Adding fairing lower speakers to your current two-speaker system increases the available sound pressure level, permitting higher listening volume, lower distortion and improved clarity at highway speeds. The pair of 5.25" waterproof 2-ohm full range speakers feature suspended 1.0" tweeters that are directionally optimized for improved rider acoustics. The injection-molded woofer cones feature high-flux Neodymium magnets for more power with less weight. The speakers nestle into the glove box area of the available Vented Fairing Lower (sold separately), providing a combination of great sound and added weather protection. Kit includes left and right speakers, glove box mounts and installation hardware. Fairing lowers and model-specific wiring harness sold separately. Speakers feature two-year warranty.

**76000050** **\$249.95**

Fits '06-'13 FLHT, FLHTC, FLHTCU, FLHTCUTG, FLHX (except FLHXSE2/3) and FLHXXX models. FLHTCU and FLHTCUTG models require separate purchase of Boom! Audio Speaker Expansion Kit P/N 76000263. Also fits '10-'13 FLTRX models (except FLTRXSE/2) and '11-'13 FLTRU models. Requires separate purchase of Color-Matched Vented Fairing Lower Kit and appropriate Wiring Harness. Does not fit models equipped with Heavy Breather Air Cleaner. Not for use with Boom! Audio Music and Intercom Kit P/N 77107-09, Boom! Audio Music and Intercom Kit P/N 77108-09 or Quick-Release Fairing Lower Hardware Kit P/N 58146-07. Dealer Digital Technician® software update is required. Dealer installation is recommended.



A. BOOM! AUDIO FAIRING LOWER SPEAKER KIT

### B. BOOM!™ AUDIO REAR SPEAKER POD KIT\*

Add concert-hall sound to your motorcycle. Boom! Audio Rear Speaker Pod Kit includes Boom! Audio High Performance rear speakers, rear speaker pods and passenger controls for rear headset volume, CB PTT and radio tuning. For even more bass performance, add the Boom! Audio Bass Booster Tour-Pak® Port Kit P/N 76000013 (sold separately). Speakers feature two-year warranty.

**76000021** **\$499.95**

Fits '06-'13 Touring models (except FLHXSE2/3 and FLTRXSE/2) equipped with an Advanced Audio Radio and a rigid-mount King Tour-Pak luggage system. Requires installation of appropriate Wiring Harness. Dealer Digital Technician software update is required.



B. BOOM!™ AUDIO REAR SPEAKER POD KIT

### C. BOOM!™ AUDIO BASS BOOSTER TOUR-PAK® PORT KIT

This Bass Booster Port Kit provides significant improvements in bass response without adding a subwoofer and has no impact on useable Tour-Pak carrier cargo capacity. When installed, the open port permits the speaker pod to "breathe," reducing the compression effect that limits speaker cone travel. You hear a 21% increase in bass response for better sound with a fuller bottom end and an 82% reduction in peak distortion for accurate bass reproduction. Noticeable improvement is gained with both Original Equipment and Boom! Audio High Performance Speakers. The kit contains black-anodized aluminum ports, stainless steel audio-transparent grills and unique Sound Sealing technology to give you that Boom! you were looking for.

**76000013** **\$89.95**

Fits '06-'13 FLHTCU, FLHTCUTG, FLHTK and FLTRU models. Also fits '06-'11 FLHTCUSE models and other Touring models equipped with King Tour-Pak and Boom! Audio Rear Speaker Pod Kit. '06-'10 FLHTCUSE models require replacement of Original Equipment amplifier. Does not fit with Boom! Audio High Output Sound System P/N 76418-06 or 76418-06A. Dealer Digital Technician software update is required. Dealer installation is recommended.



C. BOOM!™ AUDIO BASS BOOSTER TOUR-PAK PORT KIT

*Notice: The prices appearing in this catalog are the manufacturer's suggested retail prices. Actual retail prices may vary.*

# AUDIO & GAUGES 659

Boom!™ Audio – '06-'13 Touring



**D. BOOM! AUDIO SADDLEBAG SPEAKER KIT**



**D. BOOM! AUDIO SADDLEBAG SPEAKER KIT**



**E. CVO SADDLEBAG SPEAKER EXPANSION KIT**

## D. BOOM!™ AUDIO SADDLEBAG SPEAKER KIT\*

Grab the best seat in the house. Boom!™ Audio Saddlebag Speakers provide two powerful rear speakers, directed at the rider for concert sound. Saddlebag mounted speakers increase the available sound pressure level and produce higher listening volume, lower distortion and improved clarity at highway speeds. The latched and gasket-sealed saddlebag acts as a large speaker enclosure to enhance bass response. The pair of 5" x 7" waterproof 2-ohm full range speakers feature suspended 1" tweeters that are directionally optimized for improved rider acoustics. The vacuum-formed woofer cones feature high-flux Neodymium magnets for more power with less weight. Extensively tested to withstand the harshest riding conditions, the speakers fit seamlessly in custom-designed saddlebag lids (sold separately) and are covered by stylish but durable mesh speaker grills. Kit includes left and right speakers, grills, protective mounting baskets, rear wiring harness and installation hardware. Saddlebag lids and model-specific wiring harness (sold separately). Speakers feature two-year warranty.

**76000202** **\$399.95**

Fits '06-'13 Touring models (except FLHXSE3 and FLTRXSE2) with Advanced Audio Radio. FLHXSE2 and FLTRXSE models require separate purchase of CVO™ Speaker Expansion Kit P/N 76000263. Requires separate purchase of appropriate Saddlebag Lids and Wiring Harness. Not for use with Boom! Audio Music and Intercom Kit P/N 77107-09, Boom! Audio Music and Intercom Kit P/N 77108-09. Dealer Digital Technician® software update is required. Dealer installation is recommended.

## E. CVO™ SADDLEBAG SPEAKER EXPANSION KIT

Add the latest in audio performance to your CVO Street Glide® or Road Glide® model. This kit includes all the audio components required to equip your '11 FLHXSE2 and '12 FLTRXSE models with the added volume and deeper bass provided by saddlebag lid-mounted speakers. Kit includes the 100-watt/channel saddlebag-mounted amplifier and a pair of waterproof 5" x 7" saddlebag lid speakers that are perfectly matched to the Original Equipment fairing and fairing lower mounted speakers. The kit also includes speaker grills, mounting baskets, wiring harness and all installation hardware. All you need to add are color-matched saddlebag lids (sold separately).

**76000275** **\$999.95**

Fits '11 FLHXSE2 and '12 FLTRXSE models with Original Equipment audio configuration. Dealer Digital Technician software update is required. Dealer installation is recommended.

### Also available:

#### COLOR-MATCHED SADDLEBAG SPEAKER LIDS\*

Custom saddlebag lids are shaped to accommodate Boom!™ Audio Saddlebag Lid Speakers. Speaker openings are formed to angle the speakers and direct the sound forward toward the rider and passenger. Lids are also available unpainted ready for your custom paint design. Kit includes saddlebag lid, lid gasket, mounting plate and striker plates and installation reuses Original Equipment hinges, locks and mounting hardware.

Fits '06-'13 Touring models equipped with Boom! Audio Saddlebag Speaker Kit P/N 76000202.

See page 808 for complete list of available Color-Matched options.

\* NOTE: The H-D® Advanced Audio Radio or H-D Boom! Audio Amplifier will power up to a total of 4 speakers. A 3rd and 4th pair of speakers require the use of Speaker Expansion Kit P/N 76000263. Additional speaker options include Boom! Audio Fairing Lower Speakers, Boom! Audio Saddlebag Lid Speakers or Boom! Audio Tour-Pak® Rear Speakers.

### Model Family Fitment:

- V-ROD
- SPORTSTER
- DYNA
- SOFTAIL
- TOURING

Notice: The prices appearing in this catalog are the manufacturer's suggested retail prices. Actual retail prices may vary.



# 660 AUDIO & GAUGES

Communications – '06-'13 Touring

## A. BOOM!™ AUDIO MUSIC AND INTERCOM KIT

Add headphone-access music and rider-to-passenger communication to your Advanced Audio System-equipped Touring bike. The stock radio can be programmed to enable the integrated intercom mode that works flawlessly as you ride down the road and this wiring kit includes the addition of front- and rear-communication ports to bikes without rear speaker pods or Tour-Pak® luggage. Discrete tank and rear fender pods accept 7-pin plugs for rider and passenger headsets that allow the rider and passenger to listen to infotainment programming without disturbing the neighbors. The rear port features a separate volume control, so both rider and passenger can adjust the sound to comfortable levels.

This kit also permits installation of a H-D® Detachables™ Tour-Pak carrier to your rear speaker-equipped Ultra and Ultra Limited models. By relocating the headphone jack and the push-to-talk control from the speaker pod to the rear fender, full radio and communications function is retained when you remove the Tour-Pak.

Kit includes rider and passenger plug-in pods, fairing speaker/headset switch, left-side hand control with push-to-talk switch and required mounting hardware. Works with full- or half-helmet headsets (sold separately).

**77107-09 \$399.95**

Fits '07-'13 Touring (except FLHXSE2/3, FLTRX and FLTRXSE/2) and '10-'11 FLHXXX, equipped with Advanced Audio Radio. Requires installation of Intercom System Flash P/N 76441-06/DT. Models equipped with Road Tech™ Navigation Interface Module P/N 76000024, Boom!™ Audio iPod® Interface P/N 76476-10, Boom! Audio SiriusXM® Satellite Radio P/N 76404-06, Boom! Audio Bike-to-Bike Communications Kit P/N 76416-06C or any other audio/speaker accessory should use Advanced Audio Intercom Add-On Kit P/N 77108-09A. Not for use with Boom! Audio Saddlebag Speaker Kit P/N 76000202.

### Bike-to-Bike Communication Feature:

In addition to all the features of the Boom! Audio Music and Intercom Kit, Kit P/N 77108-09A can also provide bike-to-bike communications features. The Boom! Audio Music And Intercom Kit enables high quality, high range, hassle free Bike-to-Bike communications with the purchase of Communication Kit P/N 76416-06C, Wiring Harness P/N 70169-06 and model-specific CB Antenna. This will allow you and your passenger to talk to other riders, even when you are miles apart.

**77108-09A \$399.95**

Fits '07-'13 Touring (except FLHXSE2/3, FLTRX and FLTRXSE/2) and '10-'11 FLHXXX, equipped with Advanced Audio Radio and Road Tech Navigation Interface Module P/N 76000024, Boom! Audio iPod® Interface P/N 76476-10, Boom! Audio SiriusXM Satellite Radio P/N 76404-06, Boom! Audio Bike-to-Bike Communications Kit P/N 76416-06C or any other audio/speaker accessory. Requires installation of appropriate Wiring Harness and Intercom System Flash P/N 76441-06/DT. Not for use with Boom! Audio Saddlebag Speaker Kit P/N 76000202 or Boom! Audio Fairing Lower Speaker Kit P/N 76000050.



A. BOOM! AUDIO MUSIC AND INTERCOM KIT

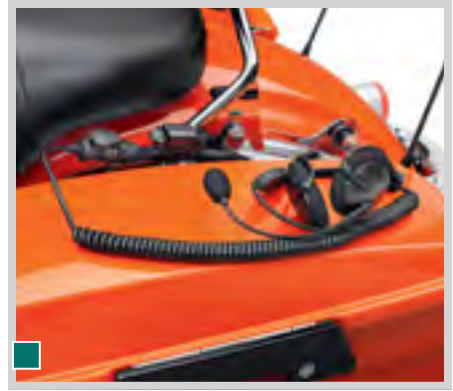

A. BOOM! AUDIO MUSIC AND INTERCOM KIT



A. BOOM! AUDIO MUSIC AND INTERCOM KIT (77107-09 SHOWN)



A. BOOM! AUDIO MUSIC AND INTERCOM KIT (77108-09A SHOWN)

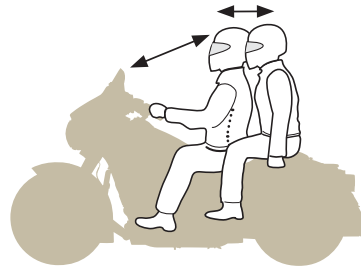

A. HEADSET ACCESS TO MUSIC AND NAVIGATION COMMANDS FOR RIDER OR PASSENGER – FM/AM, CD, IPOD PLAYER OR SIRIUSXM RADIO

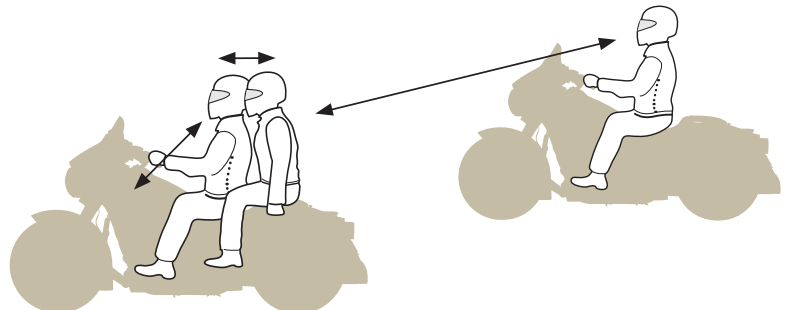

A. BOOM! AUDIO MUSIC AND INTERCOM KIT

### Model Family Fitment:

- V-ROD
- SPORTSTER
- DYNA
- SOFTAIL
- TOURING

*Notice: The prices appearing in this catalog are the manufacturer's suggested retail prices. Actual retail prices may vary.*

# AUDIO & GAUGES 661

Communications – '06-'13 Touring



**B. BOOM! AUDIO BIKE-TO-BIKE (B2B) COMMUNICATIONS KIT**

**B. BOOM!™ AUDIO BIKE-TO-BIKE (B2B) COMMUNICATIONS KIT**

Communicate with your friends on any of 40 channels. Easy-to-use handlebar controls allow PTT and adjustable squelch levels for maximum performance and reception quality. Integrated CB System will mute the radio while in transmit or receive mode. Bike-to-Bike system allows you and your passenger to talk with other riders, even when you are miles apart.

**76000390** **\$349.95**

Fits '06-'13 Touring models equipped with an Advanced Audio Radio (except FLHXSE2/3, FLTRX and FLTRXSE/2). Requires separate purchase of additional components (see your Dealer or instruction sheet for model-specific requirements).

**C. BOOM! AUDIO MUSIC AND INTERCOM KIT – TOUR-PAK® MODELS**

Keep the lines of communication open. This easy-to-use voice activated intercom system allows the rider and passenger to communicate without resorting to hand signals. Independent volume controls allow rider and passenger to adjust the sound to comfortable levels. The integrated system automatically lowers the radio volume when the intercom is in use.

**76440-06** **\$99.95**

Fits '08-'13 Touring models equipped with an Advanced Audio Radio and a Tour-Pak® luggage system. Requires installation of appropriate Wiring Harness, Intercom System Flash P/N 76441-06/DT, Rear Speaker Kit P/N 76000021, Communications Switch Kit P/N 77173-08.



**C. BOOM! AUDIO MUSIC AND INTERCOM KIT – TOUR-PAK MODELS**

**D. BOOM! AUDIO COMMUNICATIONS SWITCH KIT**

Allows the use of a Harley-Davidson® helmet headset on Touring models that are not equipped with the helmet headset interface. This kit contains Console Pod Assembly, Left-Hand Control Switch Assembly and Fairing Speaker Switch.

**77173-08** **\$259.95**

Fits '08-'13 Touring (except FLHXSE2/3, FLTRX and FLTRXSE) and '10-'11 FLHXXX, equipped with an Advanced Audio Radio System. Installation requires separate purchase of appropriate Wiring Harness. FLHX models require separate purchase of additional installation components (see instruction sheet).

**E. BOOM! AUDIO SYSTEM WIRING HARNESSES**

Allows installation of multiple Boom!™ Audio accessory combinations and allows any or all of the following: SiriusXM®, Bike-to-Bike and other communications kits, headsets, additional speakers, amplifiers, iPod® Interface and Navigation Interface.

**70169-06A** **\$114.95**

Fits '06-'13 FLHT, FLHX, FLHTC, FLTR, FLTRX, '10-'11 FLHXXX, '09 FLTRSE and '10 FLHXSE models equipped with Advanced Audio Radio. Does not fit '11-'13 CVO™ models.

Allows installation of SiriusXM Satellite Radio Kit on Ultra models. Does not provide connections for additional components.

**70172-06** **\$49.95**

Fits '06-'13 FLHTCU, FLHTK, FLTRU and FLHTCUTG models equipped with Advanced Audio Radio.

Allows installation of Boom! Audio Fairing Amplifier with additional speakers. Also allows installation of iPod Interface and/or Navigation Interface Module on select models. See dealer for details.

**69200106** **\$39.95**

Fits '06-'13 Touring and '10-'11 FLHXXX models.

Allows installation of iPod Interface and/or Navigation Interface Module on models not previously equipped with other Boom! Audio accessories. If additional Boom! Audio accessories will be installed, see dealer for details.

**69200033** **\$19.95**

Fits '06-'13 Touring and '10-'11 FLHXXX models.



**D. BOOM! AUDIO COMMUNICATIONS SWITCH KIT**



**E. BOOM! AUDIO SYSTEM WIRING HARNESSES**

*Notice: The prices appearing in this catalog are the manufacturer's suggested retail prices. Actual retail prices may vary.*



## 662 AUDIO & GAUGES

Boom!™ Audio – Cruiser Bikes

### A. BOOM!™ AUDIO CRUISER AMP AND SPEAKER KIT – WINDSHIELD MOUNT

Add a custom sound system to your windshield-equipped model. This Boom!™ Audio Cruiser Amp and Speaker Kit features a stylish black and chrome enclosure that mounts to the inside of the windshield and because it rests below the cross brace, it maintains a low-profile appearance. The water-proof enclosure conceals the great-sounding 3.5" speakers behind a rich black grill and the surrounding chrome band adds a stylish finishing touch. Want to strip your bike down? Then just unplug the speaker enclosure wiring and the unit can be removed with the detachable windshield. The compact two-channel, 40-watt stereo amplifier mounts out of the way on the frame down tubes and the .125" (3.5mm) stereo auxiliary input connects to most portable audio players, some of which can be easily housed in our convenient Boom! Audio Music Player Tank Pouch. The integrated hand control features volume up/down buttons and a backlit on/off button and is designed for easy operation with your right thumb, even while wearing gloves. Complete kit includes all wiring and mounting hardware.

**76321-09A** **\$399.95**

Fits '12-later FLD, '09-later FLS, FLSTC, '15-later FLRT and '00-later FLHR/C with stock, low-profile or tall King-Size windshields. Fits '07-later FLSTF and FLSTFB with detachable King-Size windshields. Also fits '00-later FXS, FXST, FXSTB models equipped with Mounting Bracket P/N 76000155. '12-later Dyna® and '11-later Softail® models require separate purchase of Electrical Connection Kit P/N 72673-11. '14-later FLHR, FLHRC and FLRT models require Electrical Connection Kit P/N 69200722. All other years and models require separate purchase of Relay Service Kit P/N 69200397. Does not fit with handlebar mounted gauges, windshield bags, Nostalgic, Sport, Super Sport or Quick-Release Compact detachable windshields. Does not fit with Frame Mounted Highway Pegs P/N 50855-09 or 50865-09 or Softail Freight Train Chrome Headlight Nacelle. Not for use with Boom! Audio Mount P/N 76390-05A.

**Also available:**

### BOOM! AUDIO WINDSHIELD CRUISER SPEAKER/AMP MOUNTING BRACKET

Required for installation of Windshield Mount Boom! Audio Cruiser Speaker and Amplifier Kit P/N 76321-09 on detachable compact windshields.

**76000155** **\$39.95**

Fits '00-later FXST, FXSTB and '11-later FXS models equipped with H-D® Detachables™ Compact Windshields. FXS models require separate purchase of Horn Relocation Kit P/N 69015-08.



A. BOOM! AUDIO CRUISER AMP AND SPEAKER KIT – WINDSHIELD MOUNT



A. BOOM! AUDIO CRUISER AMP AND SPEAKER KIT – WINDSHIELD MOUNT

*Notice: The prices appearing in this catalog are the manufacturer's suggested retail prices. Actual retail prices may vary.*

# AUDIO & GAUGES 663

Boom!™ Audio – Cruiser Bikes

## B. BOOM!™ AUDIO CRUISER AMP AND SPEAKER KIT

Add tunes to your ride. These Boom!™ Audio Cruiser Amp and Speaker Kits provide amplified music through two great-sounding 3.5" speakers. Available in chrome or black finish, the individual speaker pods clamp to either a 1.0" or 1.25" handlebar and can be adjusted to direct the sound toward the rider. The waterproof speaker elements are protected behind stylish black and chrome grills that are finished with a center-mounted Bar & Shield medallion. The compact two-channel, 40-watt stereo amplifier mounts out of the way on the frame down tubes and the .125" (3.5mm) stereo auxiliary input connects to most portable audio players, some of which can be easily housed in our convenient Boom! Audio Music Player Tank Pouch. The integrated hand control features volume up/down buttons and a backlit on/off button and is designed for easy operation with your right thumb, even while wearing gloves. Complete kit includes all wiring and mounting hardware.

Fits '04-later XL, '12-later FLD, '10-later FXDWG, '00-later Softail® (except FLS and FXS), '15-later FLRT and '99-later Road King® models. '14-later XL, '12-later Dyna® and '11-later Softail models require separate purchase of Electrical Connection Kit P/N 72673-11. '14-later FLHR, FLHRC and FLRT models require Electrical Connection Kit P/N 69200722. All other years and models require separate purchase of Relay Service Kit P/N 69200397. Not for use with Road Tech™ zūmo® and stock handlebar on XL or FXSTB models. Not for use with Boom! Audio SiriusXM® Handlebar Mount P/N 76390-05A, Frame Mounted Highway Pegs P/N 50855-09 or 50865-09, Sport Windshields, 1/4 Fairing or windshield bags.

<b>76262-08A</b>	Chrome.	<b>\$399.95</b>
<b>76320-08A</b>	Black.	<b>\$399.95</b>



**B. BOOM! AUDIO CRUISER AMP AND SPEAKER KIT – CHROME  
(SHOWN ON SOFTAIL DELUXE)**



**B. BOOM! AUDIO CRUISER AMP AND SPEAKER KIT – CHROME  
(SHOWN ON SPORTSTER)**



**B. BOOM! AUDIO CRUISER AMP AND SPEAKER KIT – CHROME**

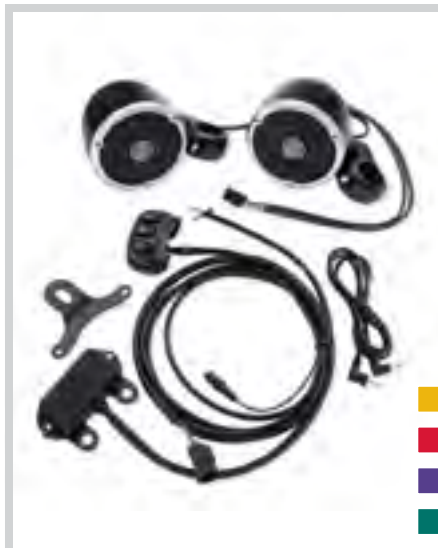

**B. BOOM! AUDIO CRUISER AMP AND SPEAKER KIT – BLACK**

### Model Family Fitment:

- V-ROD
- SPORTSTER
- DYNA
- SOFTAIL
- TOURING

*Notice: The prices appearing in this catalog are the manufacturer's suggested retail prices. Actual retail prices may vary.*



# 664 AUDIO & GAUGES

## Antennas

### A. BOOM!™ AUDIO HIDDEN AM/FM/WB ANTENNA

Hide the AM/FM/WB antenna inside the fairing for a clean, uncluttered look. Uniquely tuned to the Harley-Davidson® radio, this enhanced Hidden Antenna offers reception performance equivalent to the Original Equipment whip antenna and superior to the Boom!™ Audio Shorty Antenna. Perfect for your clean slick custom bagger, this Hidden Antenna is also the ideal addition to models equipped with H-D® Detachables™ Tour-Pak® luggage because it eliminates the need to move the whip antenna back and forth between Tour-Pak luggage and fender mounting locations. Kit includes all required mounting hardware and wiring.

NOTE: Relative antenna performance as compared to stock Original Equipment antenna; results based on reception evaluation conducted in Milwaukee area. Actual performance will be influenced by signal strength and electrical interference in your area. Follow the installation and routing instructions carefully to obtain the best possible performance from the antenna.

**76000513** **\$69.95**

Fits '14-later Touring and Trike models with Original Equipment AM/FM/WB Boom! Box Audio System. Separate purchase of Fairing Power Extension Harness P/N 69200921 is required if installed with Boom! Bagger Kits P/N 76000410 or P/N 76000411, Boom! Audio Amplifier Kit P/N 76000278. Electric Glo™ Headlamp Trim Rings or Fairing Edge Lights.

**76000266** **\$69.95**

Fits '98-'13 Touring and Trike models equipped with AM/FM/WB radio and fairing.

### B. BOOM! AUDIO SHORTY ANTENNAS

This compact antenna is only 19.0" tall and is a stylish change from the Original Equipment whip antenna. The low-profile antenna simplifies covering the bike for storage. Easy to install, the Shorty Antenna screws on to the factory antenna mount.

**76386-09A** CB Radio. **\$29.95**

Fits '09-later Touring and Trike models equipped with Bike-to-Bike Communication. May require model-specific mounting bracket if installed on a model without a Tour-Pak carrier.

**76386-08** CB Radio. **\$29.95**

Fits '98-'08 Touring models equipped with Bike-to-Bike Communication. May require model-specific mounting bracket if installed on a model without a Tour-Pak carrier.

**76388-08** AM/FM. **\$29.95**

Fits '98-later Touring and Trike models equipped with radio.

### C. AM/FM ANTENNA KIT – TOUR-PAK MOUNT

The AM/FM Antenna Kit mounts an antenna on a Tour-Pak luggage system. Kit includes Original Equipment style Fiberglass AM/FM Antenna P/N 76503-08, all necessary mounting brackets, cable hardware and instructions. Fits all Tour-Pak luggage systems.

**76251-98A** **\$44.95**

Fits '98-'13 Touring and Trike models with Tour-Pak luggage.

### D. CB ANTENNA KIT – TOUR-PAK® MOUNT

The CB Antenna Kit mounts an antenna on a Tour-Pak® luggage system. Kit includes Original Equipment style CB antenna, all necessary mounting brackets, cable hardware and instructions. Fits all Tour-Pak luggage systems.

**76400-09** **\$89.95**

Fits '09-'13 Touring models with Tour-Pak luggage. Includes Fiberglass CB Antenna P/N 76250-09.

### E. CB ANTENNA KIT – FRAME MOUNT

Will enable the installation of a CB antenna on the right side of a fender. Kit includes CB antenna and mounting brackets.

**76410-09** **\$89.95**

Fits '09-'13 FLHX, FLTR and FLTRX models. Does not fit CVO™ models. Includes Fiberglass CB Antenna P/N 76250-09.



A. BOOM! AUDIO HIDDEN AM/FM/WB ANTENNA



B. BOOM! AUDIO SHORTY CB ANTENNA (SHOWN WITH SHORTY AM/FM ANTENNA)

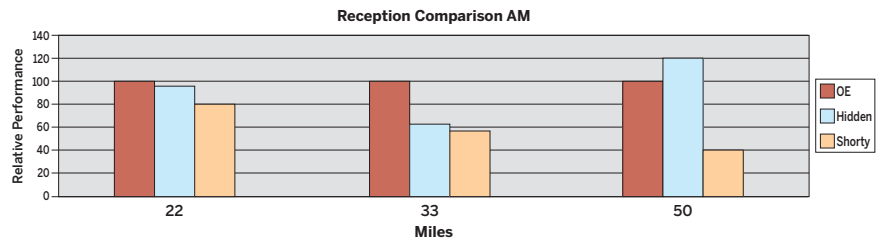
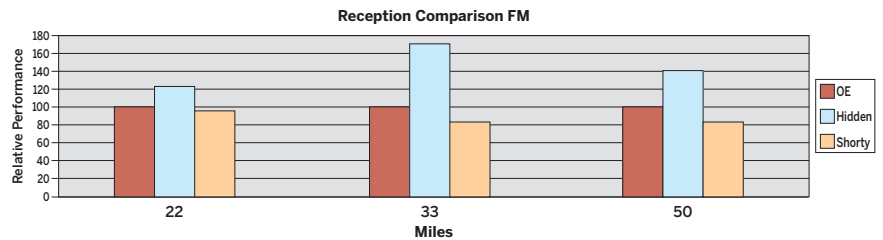

ANTENNA PERFORMANCE COMPARISON – COMPARISON MEASURED ON '06-'13 MODELS WITH ADVANCED AUDIO AM/FM/WB RADIO

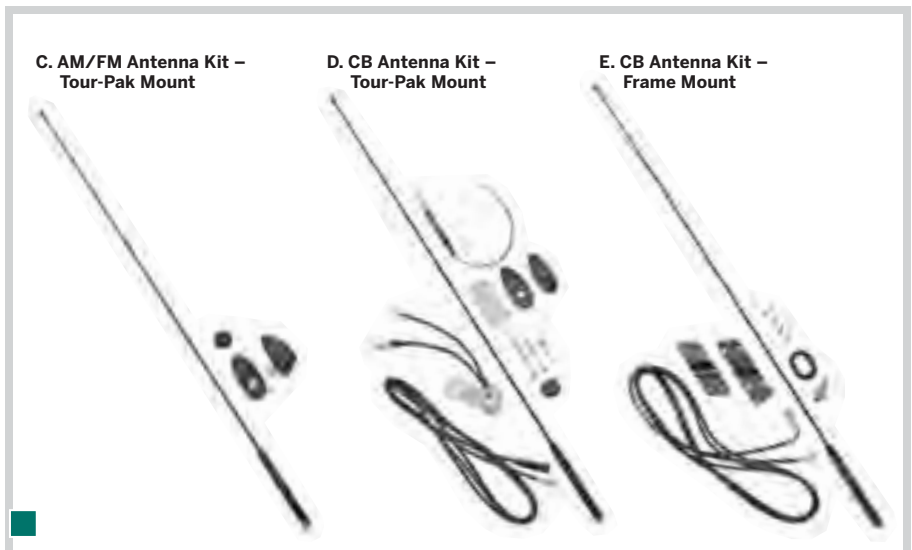

ANTENNA KITS

Notice: The prices appearing in this catalog are the manufacturer's suggested retail prices. Actual retail prices may vary.

# AUDIO & GAUGES 665

## Antennas



**F. CB ANTENNA RELOCATION KIT**



**G. AM/FM ANTENNA RELOCATION KIT**

**F. CB ANTENNA RELOCATION KIT**

Relocates your CB antenna to the rear fender to accommodate use with a H-D® Detachables™ Two-Up Tour-Pak® Luggage Mounting Rack. Kit includes mounting bracket, all mounting hardware and wiring harness.

**76000308** **\$69.95**

Fits '14-later FLHTCU, FLHTCUL, FLHTK, FLHTKL, FLHTKSE and FLTRUSE models equipped with H-D Detachables Tour-Pak Conversion Kit P/N 53000291.

**G. AM/FM ANTENNA RELOCATION KIT**

Relocates your AM/FM antenna to the rear fender to accommodate use with an H-D Detachables Two-Up Tour-Pak Mounting Rack. Kit includes mounting bracket, all mounting hardware and wiring harness.

**76000582** **\$69.95**

Fits '14-later FLHX, FLHXS, FLTRX and FLTRXS models.

**H. ANTENNA RELOCATION KIT FOR FLTR/FLHX WITH H-D® DETACHABLES™ TWO-UP LUGGAGE RACK**

Relocate your AM/FM antenna for use with H-D Detachables Two-Up Luggage Rack.

**76561-09** **\$29.95**

Fits '09-'13 FLHX, FLTR, FLTRU and FLTRX models (except FLTRUSE, FLTRXSE/2, FLTRSE3/4 and FLHXSE/2/3 models) equipped with Detachable Two-Up Luggage Rack P/N 54215-09. Does not fit with Nostalgic Saddlebag Guard Rail Kit P/N 91286-10.

**76208-07** **\$34.95**

Fits '97-'08 FLTR and FLHX equipped with Detachable Two-Up Luggage Rack P/N 53743-97 and Two-Up Detachable Docking Hardware Kit P/N 53804-06.

**I. ANTENNA RELOCATION KIT – AM/FM**

This Antenna Relocation Kit allows you to easily switch between your detachable Tour-Pak luggage, a detachable passenger backrest or the clean look of a stock FLHT or FLTR.

**76556-09** **\$69.95**

Fits '09-'13 FLHT, FLHTC, FLHX, FLTR and FLTRX models. Does not fit CVO™ models.

**76326-00A** **\$119.95**

Fits all '98-'08 FLHT, FLHX and FLTR models.



**H. ANTENNA RELOCATION KIT FOR FLTR/FLHX WITH H-D DETACHABLES TWO-UP LUGGAGE RACK**



**I. ANTENNA RELOCATION KIT, AM/FM '09-'13 MODELS**



**I. ANTENNA RELOCATION KIT, AM/FM '98-'08 MODELS**



**I. ANTENNA RELOCATION KIT, AM/FM '98-'08 MODELS**

**Model Family Fitment:**

- V-ROD
- SPORTSTER
- DYNA
- SOFTAIL
- TOURING

*Notice: The prices appearing in this catalog are the manufacturer's suggested retail prices. Actual retail prices may vary.*



# ROAD TECH™ ZŪMO® GPS NAVIGATOR

Whether you're on a weekday ride across town or a week-long trip to a rally with friends, Road Tech™ zūmo® is ready to show you the way.



## MOTORCYCLE FRIENDLY DESIGN

zūmo® 660 and 665 features:

- Glove-friendly touchscreen with easy scroll design
- Built-in Harley® Dealer Database
- Rugged vibration-tested and approved mounts
- Unique satin black case complements hand control finishes
- Kit includes Automotive Mounting Kit
- Two-year warranty

zūmo 665 additional features:

- Can be linked to the Advanced Audio Radio for integrated operation
- Includes Free Activation and three months free SiriusXM® Satellite Radio with the XM Select Package, Radio NavTraffic® and NavWeather® subscriptions\*

### DESIGNED BY BIKERS FOR BIKERS

The bright 4.3" high-resolution color display is easy to read – day or night – and the glove-friendly touch screen and intuitive interface makes entering your destination a breeze. And with a rugged water-proof case, zūmo GPS was built for life on the road. Complete kit includes: zūmo GPS, Preloaded City Navigator® NT for North America, mounting cradle with integrated power cable, carrying case, mount dust cover, battery pack, charger, automotive suction cup mount and power cable, USB cable and owner's manual.

### PLUG AND PLAY

Don't wait to hit the road – simply plug in the Road Tech™ zūmo GPS and go. It's preloaded with City Navigator NT street maps and millions of points of interest (POIs) that include motels, restaurants, gas stations, ATMs and more. If you're in unfamiliar territory, the zūmo GPS offers 3-D building view and lane assist with junction view so you know just how to get where you're going. And there's no need to worry about running out of gas on your motorcycle – Road Tech zūmo features a digital gauge that lets you know when it's time to fuel up.

### PLAN & SHARE YOUR RIDES

The Road Tech zūmo model's trip-planning tools make it easy to design a cross-country trip. You can create your own custom routes via Ride Planner by visiting [www.H-D.com](http://www.H-D.com) and then transfer the route directly to your zūmo. When the ride is over, you can go over your rides in Google Earth™. The microSD™ card expansion means you can share routes and add storage.

### THAT'S ENTERTAINMENT

If you're going on a long ride, the Road Tech zūmo GPS will keep you entertained the entire way. It features a built-in MP3 player and advanced Bluetooth A2DP technology, so you can listen to gorgeous stereo sound and audio books as the miles fly by. zūmo 665 models also offer SiriusXM Radio (subscription required)\* giving you the choice of over 170 entertainment channels including news, sports, talk, commercial-free music and more.

### SMOOTH TALK

The Road Tech zūmo GPS's Bluetooth® wireless technology lets you talk on your phone without taking off your helmet or gloves. Just connect the unit to most Bluetooth-enabled headsets or helmets and pair it with your cell phone to make and receive calls.

### AND THERE'S MORE

zūmo 665 adds SiriusXM Satellite Radio, NavTraffic and NavWeather. You know how to stay ahead of a storm or when to don your rain gear. Simply upgrade your SiriusXM Radio subscription to include NavWeather to access continuously updated weather data and weather radar graphics from your map screen. Plus, when you add NavTraffic, you can find out where the trouble spots are and route around them. The zūmo 665 kit includes the GXM™ 40 XM antenna.

\*SiriusXM TERMS: Free activation, a \$15.00 value. SiriusXM Satellite Radio, NavTraffic and NavWeather subscriptions sold separately or as a package. NavTraffic available in select markets. NavWeather data displays and individual product availability vary by hardware equipment. Upon the expiration of the 3-month promotional period, service automatically renews and you will be billed, at then-current rates, until you call 1-866-635-2349 to cancel. Subscriptions are governed by the SiriusXM Customer Agreement; see [www.siriusxm.com](http://www.siriusxm.com). XM U.S. Satellite Service available only to those at least 18 years of age in the 48 contiguous USA and DC, while SiriusXM Internet Radio is available throughout our satellite area and also in AK, HI and PR.

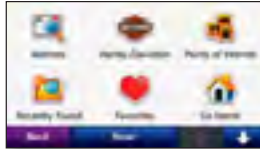

**MENU SCREEN**



**3-D BUILDING VIEW**



**OVERHEAD MAPPING**



**LANE ASSIST**

**WIDE SCREEN**

Touch-screen access to programming, 3-D and overhead maps and digital dashboard.



**TRIP COMPUTER**



**SIRIUSXM® SATELLITE RADIO (zūmo® 665 only)**

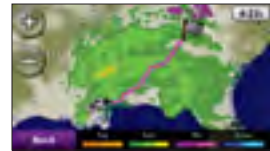

**WEATHER RADAR (zūmo 665 only)**

Features	zūmo® 660	zūmo® 665
Display size, WxH:	4.3" Diag (10.9 Cm)	4.3" Diag (10.9 Cm)
Display type:	Color with Backlight	Color with Backlight
Rechargeable battery:	Removable, Lithium-Ion	Removable, Lithium-Ion
Battery life:	Up to 5 Hours	Up to 3 Hours
Headphone jack/audio line-out:	Yes	Yes
High-sensitivity receiver:	Yes	Yes
Waterproof:	Yes	Yes
Preloaded street maps:	Yes	Yes
3-D buildings and landmarks view:	Yes	Yes
Built-in memory:	Internal Solid State	Internal Solid State
Accepts MicroSD™ data cards:	Yes	Yes
Waypoints/favorites/locations:	1000	1000
Routes:	20	20
Voice prompts:	Yes (Internal Speaker)	Yes (Internal Speaker)
Speaks street/names:	Yes	Yes
Lane assist:	Yes (with junction view)	Yes (with junction view)
Route setup (faster time, shorter distance, off road):	Yes	Yes
Route avoidance:	Yes	Yes
Bluetooth® wireless technology:	Yes (A2DP)	Yes (A2DP)
Road speed limit indicator:	Yes	Yes
Where am I? (find closest hospitals, police & gas stations, nearest address & intersection):	Yes	Yes
Custom POI (point of interest):	Yes	Yes
World clock, calculator:	Yes	Yes
Qwerty or ABC keyboard layout:	Yes	Yes
Picture viewer:	Yes	Yes
MP3 player:	Yes	Yes
Audio book player:	Yes	Yes
Compatible with Windows XP or newer:	Yes	Yes
Compatible with Mac OS X10.4 or newer:	Yes	Yes
SiriusXM® radio (for U.S.):	No	Yes (Subscription)
SiriusXM NavTraffic®	No	Yes (Subscription)
SiriusXM NavWeather®	No	Yes (Subscription)
SiriusXM antenna	No	Included (GXMTM 40)
Car mount:	Included	Included
Power cable:	Included	Included
USB cable:	Included	Included
Carrying case:	Included	Included

Part number:	92115-09A	7600014A
Available to fit:	Fits '02-later VRSC™ (except VRSCF and VRSCR), '96-later XL, XR, Dyna®, Softail®, Touring and Trike models with separate purchase of Handlebar Mount Kit P/N 76000191A, 76000192A or Fairing Mount Kit P/N 92238-09. '14-later XL, '12-later Dyna and '11-later Softail models require separate purchase of Electrical Connection Kit P/N 72673-11. '14-later Touring and Trike models require Electrical Connection Update Kit P/N 69200722. Also fits most automobile windshields or dash.	Fits '02-later VRSC (except VRSCF and VRSCR), '96-later XL, XR, Dyna, Softail, Touring and Trike models with separate purchase of Handlebar Mount Kit P/N 76000191A, 76000192A or Fairing Mount Kit P/N 92238-09. '14-later XL, '12-later Dyna and '11-later Softail models require separate purchase of Electrical Connection Kit P/N 72673-11. '14-later Touring and Trike models require Electrical Connection Update Kit P/N 69200722. Also fits most automobile windshields or dash. Requires separate purchase of Road Glide® Antenna Fairing Mount P/N 76000016 or Road Tech Antenna Pouch P/N 76000061. Electra Glide® SiriusXM Antenna Mount included.
MSRP:	<b>\$649.95</b>	<b>\$799.95</b>



# 668 AUDIO & GAUGES

## Navigation

### A. ROAD TECH ZŪMO® HANDLEBAR MOUNT KIT

This installation kit is designed for handlebar mounting of the Road Tech zūmo® 660/665 GPS system on specified Harley-Davidson® models. Replacing the left-hand half clamp, this sweeping chrome or gloss black bracket accepts the connection cradle for the Road Tech zūmo GPS system. Fits 1" and 1.25" handlebars.

Fits '02-later VRSC™ (except VRSCF and VRSCR), '96-later XL, XR, Dyna®, Softail®, Road King®, Road Glide® and '14-later Touring and Trike models equipped with Road Tech zūmo 660 or 665 GPS units. XL and XR models require separate purchase of (2) Screw P/N 4669M. Does not fit with Road Tech Satellite Radio, Left-Hand Auxiliary Switch Housing or Clutch Lever Bracket Clamp Clock or Thermometer. Must be wired on exterior of handlebar.

<b>76000191A</b>	Chrome.	<b>\$134.95</b>
<b>76000192A</b>	Gloss Black.	<b>\$134.95</b>



A. ROAD TECH ZŪMO HANDLEBAR MOUNT KIT

### B. ROAD TECH ZŪMO FAIRING MOUNT KIT

This installation kit is designed to allow fairing mounting of the Road Tech zūmo GPS System on specified Harley-Davidson models. Positioned for convenient viewing by both the rider and passenger, the Mounting Kit easily accepts the slide-in connection cradle for the Road Tech zūmo 660/665 GPS System. Kit includes bracket and all required hardware. Installation requires drilling through inner fairing.

**92238-09** **\$49.95**  
Fits '96-'13 Electra Glide®, Street Glide® and Trike models equipped with Road Tech zūmo 660 or 665 GPS unit. Does not fit with Road Tech SiriusXM® Satellite Radio P/N 76390-05A, '06-'10 CVO™ Electra Glide models or models equipped with Fairing Dash Pad P/N 58262-05.



A. ROAD TECH ZŪMO HANDLEBAR MOUNT – CHROME

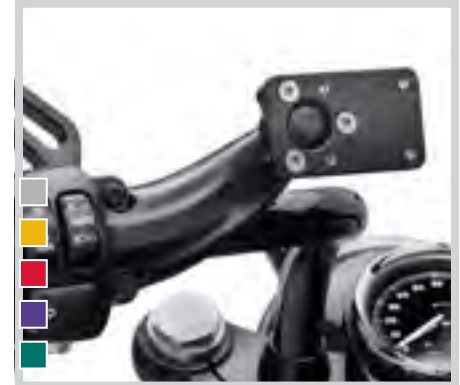

A. ROAD TECH ZŪMO HANDLEBAR MOUNT – GLOSS BLACK

### C. ROAD TECH NAVIGATION INTERFACE MODULE

Available exclusively for Harley-Davidson Road Tech zūmo Navigation Systems. The Navigation Interface Module will provide an integrated link between the fairing-mounted Advanced Audio Radio and a Road Tech zūmo 660 or 665 GPS Navigator. When linked, the music volume will automatically drop when a GPS spoken command is detected, allowing you to hear the instructions through the radio speakers or the 7-pin communications-style headset. The module attaches directly to the radio and is concealed within the fairing. Kit includes adaptor cable that permits stereo sound from the zūmo unit's internal MP3 player or SiriusXM Radio if connected into radio's AUX input.

**76000024A** **\$169.95**  
Fits '06-'13 Touring models (except FLHXSE3 and FLTRXSE2) equipped with the Advanced Audio system and a Road Tech zūmo 660 GPS Navigator P/N 92115-09 or Road Tech zūmo 665 GPS Navigator P/N 76000014. FLHXSE2 and FLTRXSE models require separate purchase of CVO Speaker Expansion Kit P/N 76000275, '06-'13 FLHX, FLTR, FLTRX and FLHTC models and those not equipped with Wiring Harness P/N 70169-06 require the separate purchase of Connector Kit P/N 69200033. Not for use with Advanced Audio Hands Free Cell Phone Kit P/N 76408-06.



B. ROAD TECH ZŪMO FAIRING MOUNT KIT

#### Model Family Fitment:

Grey	Yellow	Red
V-ROD	SPORTSTER	DYNA
Purple	Teal	
SOFTAIL	TOURING	



B. ROAD TECH ZŪMO FAIRING MOUNT KIT



C. ROAD TECH NAVIGATION INTERFACE MODULE

*Notice: The prices appearing in this catalog are the manufacturer's suggested retail prices. Actual retail prices may vary.*

# AUDIO & GAUGES 669

Boom!™ Audio Accessories



**D. BOOM! AUDIO SIRIUSXM SATELLITE RADIO – HANDLEBAR MOUNT**

**D. BOOM!™ AUDIO SIRIUSXM® SATELLITE RADIO – HANDLEBAR MOUNT\***

Over 170 channels to satisfy any taste in music, news, sports, talk and entertainment. The convenient handlebar-mounted receiver features large buttons that allow easy access, even while wearing gloves. Twenty pre-set stations allow easy access to your favorite channels. The multi-line LCD screen is easy to read and features an adjustable backlight for maximum daylight and nighttime visibility. SiriusXM® unit can be connected to the auxiliary input in most fairing-mount radios for concert-hall sound or used with mini-plug headsets. The complete kit includes SiriusXM receiver, adjustable handlebar mount, compact antenna and antenna mount and all wiring and installation hardware. Kit also includes automotive adapter plate and 12-volt power source for in-car use. (Requires separate purchase of compatible automobile installation kit – visit [www.shop.siriusxm.com](http://www.shop.siriusxm.com) for more information.) Activation and monthly subscription service required with additional fee. For a limited time, your first three months of service are free.

**76390-05A \$299.95**

Fits '96-later Dyna®, Softail® and '96-'13 Touring and Trike models. '12-later Dyna and '11-later Softail models require separate purchase of Electrical Connection Kit P/N 72673-11. Can be used with Original Equipment fairing mount radio, Road Tech™ Riser Mount Radio or Boom!™ Audio Music Headset. Not for use with Boom! Audio Cruiser Amp and Speaker kits, Handlebar Mount GPS Navigation System, left-hand Auxiliary Switch Housing or Clutch Lever Mounted Clock or Thermometer.

\*See SiriusXM TERMS & CONDITIONS PAGE 666

**E. BOOM! AUDIO MUSIC PLAYER TANK POUCH**

This portable music system pouch is designed for motorcycle use. The neoprene jacket offers hard-core protection for your portable music device, while the built-in magnets hold the pouch securely to the fuel tank. The clear play-through window permits touch-screen control and the anti-skid interior allows the pouch to accommodate players of various sizes. The clamshell design makes inserting your player into the pouch quick and easy and the double zipper allows for headphone and output cables to exit the pouch at any point on top, bottom or one side of the pouch. Simply plug in your headphones or connect your in-dash Advanced Audio Radio with an auxiliary cable or Boom! Audio iPod® Interface and enjoy your music collection. Works well with many MP3 and other personal music players, but should not be used with hard-disk memory players. Window measurement: 2.25" W x 4.0" H.

**76000193 \$44.95**

Fits models with steel fuel tanks or airbox covers.

**F. MAGNETIC TANK TOTE**

De-clutter your pockets. This compact and convenient magnetic pouch is the ideal place to store small items that would normally go in your jeans pocket. It's also the perfect way to enjoy the benefits of SiriusXM Satellite Radio, NavWeather® and NavTraffic® on your non-fairing equipped motorcycle. Just slip the Road Tech zūmo SiriusXM disc antenna into this pouch and the strong magnets will secure it to the top of the fuel tank, yet make it easy to move your Road Tech zūmo from the bike to the car. The durable neoprene jacket with zippered closure will keep your items safe for the ride. An embroidered Bar & Shield logo finishes the look. Pouch dimensions: 4.0" W x 5.5" H.

**76000061 \$34.95**

Fits models with steel fuel tanks or airbox covers.



**E. BOOM! AUDIO MUSIC PLAYER TANK POUCH**



**F. MAGNETIC TANK TOTE**



Notice: The prices appearing in this catalog are the manufacturer's suggested retail prices. Actual retail prices may vary.



# 670 AUDIO & GAUGES

## Headsets

### A. BOOM!™ AUDIO PREMIUM HALF HELMET MUSIC AND COMMUNICATIONS HEADSET

This comfortable headset is designed to allow full music and communication function while wearing a half helmet. Lightweight pivoting neck band wraps across the back of the neck and fits comfortably below the shell of most half helmets. Over-the-ear hooks keep speakers comfortably in place. This headset features premium voice coils and vented housings for enhanced bass, mid and high frequency response. The great-sounding foam-covered on-ear stereo headphone cups reduce wind noise while allowing you to hear surrounding traffic. The adjustable boom microphone with wind sock has been optimized for use with Harley-Davidson® intercom and Bike-to-Bike communications equipment and the streamlined cord with push button clothing clip and quick-disconnect plug allows you to step away from the motorcycle without removing the headset. The 7-pin DIN plug can be connected to the front and rear communications ports, allowing both rider and passenger access to the music, navigation and voice communications features of the motorcycle. The headset includes a custom zippered storage case for added protection.

**76000145** 7-pin DIN Connector. **\$149.95**  
 Fits '98-later FLHTC, FLHTCU, FLHTCUSE, FLHTCUTG, FLHTK, FLHTKSE, FLTRU and FLTRUSE models. Also fits with vehicles equipped with Communication Switch Kit P/N 77173-08 or Boom!™ Audio Music and Intercom Kits.

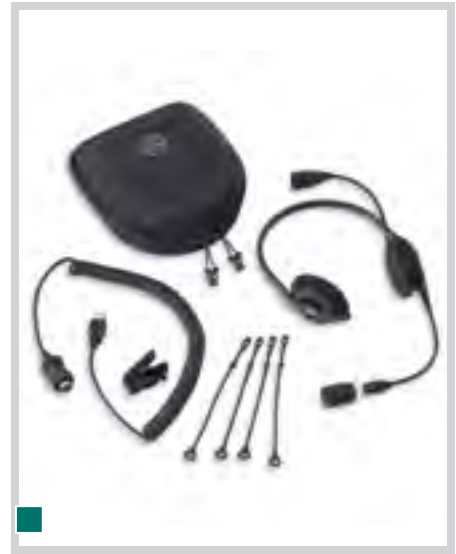

**A. BOOM! AUDIO PREMIUM HALF HELMET MUSIC AND COMMUNICATIONS HEADSET**

### B. BOOM! AUDIO HALF HELMET MUSIC AND COMMUNICATIONS HEADSET

Great-sounding foam-covered on-ear stereo headphone cups reduce wind noise while allowing you to hear surrounding traffic. This comfortable headset is designed to allow full music and communication function while wearing a half helmet. Lightweight, durable neck bow wraps around the ear and across the back of the neck and fits comfortably below the shell of most half helmets. The adjustable boom microphone with wind sock has been optimized for superior clarity when connected to Harley-Davidson intercom and Bike-to-Bike communications equipment and the quick-disconnect plug allows you to step away from the motorcycle without removing the headset. A clothing clip (not shown) is included for added comfort and reduced ear fatigue. The coiled cord permits freedom of movement in the saddle. The 7-pin DIN plug can be connected to the front and rear communications ports, allowing both rider and passenger access to the music, navigation and voice communications features of the motorcycle.

**76572-09** 7-pin DIN Connector. **\$119.95**  
 Fits '98-later FLHTCU, FLHTCUSE, FLHTCUTG, FLHTK, FLHTKSE, FLTRU and FLTRUSE models. Also fits with vehicles equipped with Communication Switch Kit P/N 77173-08 or Boom! Audio Music and Intercom Kits.

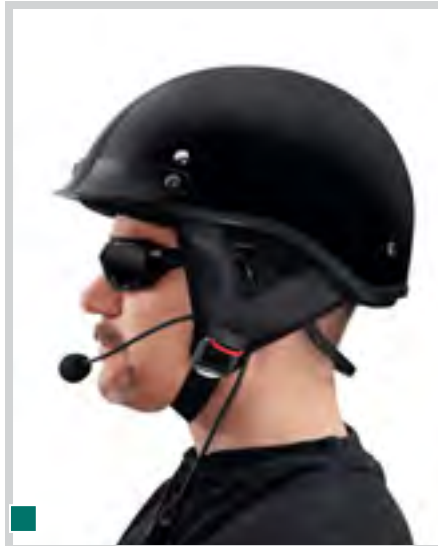

**B. BOOM! AUDIO HALF HELMET MUSIC AND COMMUNICATIONS HEADSET**

### C. BOOM! AUDIO HALF HELMET MUSIC HEADSET

Listen to music or navigation system directions while wearing a half helmet. This comfortable headset features a lightweight, durable neck bow that wraps around the ear and across the back of the neck and fits comfortably below the shell of most half helmets. The great-sounding foam-covered on-ear stereo headphone cups reduce wind noise while allowing you to hear surrounding traffic and the quick-disconnect plug allows you to step away from the motorcycle without removing the headset. A clothing clip is included for added comfort and reduced ear fatigue. The coiled cord permits freedom of movement in the saddle and the .125" (3.5mm) plug can be connected to the Road Tech™ zūmo®, Road Tech SiriusXM® Satellite Radio, MP3 players and portable stereo devices.

**76569-09** .125" (3.5mm) Mini Plug Connector. **\$79.95**  
 Fits Road Tech zūmo, Road Tech SiriusXM Satellite Radio and other electronic devices with 1/8" (3.5mm) stereo mini jack output.

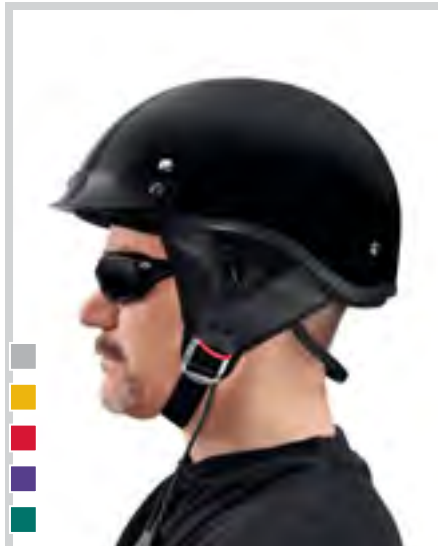

**C. BOOM! AUDIO HALF HELMET MUSIC HEADSET**

*Notice: The prices appearing in this catalog are the manufacturer's suggested retail prices. Actual retail prices may vary.*



**D. BOOM! AUDIO FULL HELMET PREMIUM MUSIC AND COMMUNICATIONS HEADSET**

**D. BOOM!™ AUDIO FULL HELMET PREMIUM MUSIC AND COMMUNICATIONS HEADSET**

This comfortable headset is designed to allow full communication function while wearing a .75 or full-face helmet. The stylish plug module clamps to the base of the helmet and positions the adjustable wind sock-equipped boom microphone for the best sound quality. Great-sounding foam-covered stereo earphones comfortably fit into ear pockets in the helmet and the fine wires are easy to hide beneath the helmet liner for a clean installation. The quick-disconnect plug allows you to step away from the motorcycle without removing the helmet and the coiled cord permits freedom of movement in the saddle. The 7-pin DIN plug can be connected to the front and rear communications ports, allowing both rider and passenger access to the music, navigation and voice communications features of your motorcycle and the microphone has been optimized for superior clarity when connected to Harley-Davidson® intercom and Bike-to-Bike communications equipment.

**77117-10** **\$189.95**

Fits '98-later FLHTCU, FLHTCUSE, FLHTCUTG, FLHTK, FLHTKSE, FLTRU and FLTRUSE models. Also fits with vehicles equipped with Communication Switch Kit P/N 77173-08 or Boom!™ Audio Music and Intercom Kits.

**E. EXTENDED LENGTH COMMUNICATIONS HEADSET CORD**



**E. EXTENDED LENGTH COMMUNICATIONS HEADSET CORD**

**F. ROAD TECH EAR BUD SPEAKER KIT**

Extended Headset Cord is an essential option for a tall rider or passenger. When compared to the stock headset cord, this cord provides five additional inches of length at rest and up to 22 additional inches of length when fully stretched. The additional length and relaxed twist of the cord reduces the spring effect and the included clothing clip eliminates the tension that can lead to neck fatigue. The 7-pin DIN plug can be connected to the front and rear communications ports, giving both rider and passenger access to the music, navigation and voice communications features of your motorcycle. This cord is a direct plug-in replacement for the standard length headset cord on the Original Equipment headset or the Boom! Audio Full Face Helmet Communications Headset P/N 77117-10.

**76000259** **\$44.95**

Fits '10-later Original Equipment Ultra-style Headsets P/N 77147-98A (Domestic) or 77156-98A (HDI), Boom! Audio Full Face Helmet Communications Headset P/N 77117-10 and Half Helmet Headsets P/N 76000145 and 76572-09.

**F. ROAD TECH™ EAR BUD SPEAKER KIT**

Convenient in-ear speaker. When plugged into the earphone jack on the GPS mount, the navigation system will speak commands without disturbing others. The comfortable Ear Bud Speaker Kit features an in-line quick-disconnect to simplify use with a helmet.

**91771-04** **\$19.95**

Fits with Road Tech™ Navigation Devices.

**G. ROAD TECH HAND-HELD CB MICROPHONE KIT**



**G. ROAD TECH HAND-HELD CB MICROPHONE KIT**

**H. WINDSOCK FOR HEADSET**

Comes complete with handlebar mounting bracket and all necessary hardware.

**76312-98** **\$99.95**

Fits '98-'13 FLHTC, FLHTCU, FLHTCUTG and FLTRU models. Also fits models equipped with Communication Kits 77107-09, 77108-09A and 77173-08.

**H. WINDSOCK FOR HEADSET**

**77126-98** **\$4.39**

Fits most H-D headsets equipped with boom microphone.

**Model Family Fitment:**

- V-ROD
- SPORTSTER
- DYNA
- SOFTAIL
- TOURING

*Notice: The prices appearing in this catalog are the manufacturer's suggested retail prices. Actual retail prices may vary.*



# 672 AUDIO & GAUGES

## Electrical Accessories

### A. AUXILIARY POWER PORT

Power your cell phone, GPS, portable music player or tire inflator from this handy 12-volt power port. Conventional style power outlet accepts most 12V automotive power adaptor plugs and features a flip-top cover to protect the port while not in use.

**69201099** Side-Panel Mount. **\$29.95**  
Fits '14-later Touring and Trike models.

**91843-97** Side-Panel Mount. **\$29.95**  
Fits '94-'13 Touring and Trike models.

**69200091** Saddlebag Mount. **\$40.95**  
Fits models equipped with 12-volt battery. Does not fit VRSC™ models, Throw-Over or Swingarm Bags. Not for use with accessory Fitted Liners or Premier Liners. Requires separate purchase of Battery Charging Harness P/N 94624-97B, if not already equipped.

**69200826** Tour-Pak® Mount. **\$40.95**  
Fits '14-later FLHTCU, FLHTCUL and FLHTCUTG models. Original Equipment on FLHTK and FLHTKL.

**91671-10** Tour-Pak Mount. **\$49.95**  
Fits '96-'13 FLHTCU and '06-'13 FLHTC, FLTRU and FLHTCUTG models. Also fits '06-'13 Touring models with accessory King Tour-Pak luggage and '98-'13 Touring models with Tour-Pak mounted rear speaker pods. Not for use with Accessory Fitted Liners or Premier Liner.

### B. USB CHARGING ADAPTOR

Charge your cell phone, MP3 players and other hand-held devices while on the road. Compact Adaptor plugs into standard or accessory 12-volt power ports and provides a standard USB-style outlet that accepts many phone and music player power cords.

**69200357** **\$19.95**  
For use with 12V Auxiliary Power Port.



A. AUXILIARY POWER PORT – SIDE-PANEL MOUNT



A. AUXILIARY POWER PORT – SADDLEBAG MOUNT



A. AUXILIARY POWER PORT – TOUR-PAK MOUNT  
'14-LATER MODELS



#### Model Family Fitment:

- V-ROD
- SPORTSTER
- DYNA
- SOFTAIL
- TOURING



A. AUXILIARY POWER PORT – TOUR-PAK MOUNT  
'96-'13 MODELS



B. USB CHARGING ADAPTOR

*Notice: The prices appearing in this catalog are the manufacturer's suggested retail prices. Actual retail prices may vary.*

# AUDIO & GAUGES 673

Electrical Accessories



**C. 54-AMP HIGH OUTPUT CHARGING SYSTEM**

## C. 54-AMP HIGH OUTPUT CHARGING SYSTEM

The Harley-Davidson® High Output Charging System is engineered to provide 30% more power than the stock system at idle. With 54 amps of output at 4000 rpm, accessories will operate at their peak performance – no more dimming lights, reduced audio performance or under-performing heated gear. This is a recommended installation anytime a multi-amp audio system is installed on the vehicle in order to achieve the full capability of your audio system. It is also recommended when installing heated seats, heated gear and other higher draw powered accessories.

Stock on select CVO™ Touring models, the complete kit includes high performance rotor, stator, voltage regulator and all gaskets and hardware required for installation.

**29900028** **\$489.95**  
Fits '11-later Touring, '10-later CVO Touring and '09-later Trike models. Stock on '14-later FLHTKSE, FLTRUSE and FLHXSE.

## D. ELECTRICAL CONNECTION UPDATE KIT – TOURING\*

Harness plugs into accessory connector to provide 12-volt power leads. Required to install Heated Grips, XM Radio, Cruiser Amp & Speaker Systems, zūmo® GPS, Digital Oil Pressure Gauge, Garage Door Opener Kits, Heated Seats and decorative lighting on '14-later Touring models.

**69200722** **\$23.95**  
Fits '14-later Touring and Trike models.

## E. ELECTRICAL CONNECTION UPDATE KIT\*

Mini 'Y' harness plugs into data port to provide 12-volt power leads and replacement data port socket. This kit is required to easily complete the installation of accessories requiring electrical power connection. For use with accessories like Road Tech™ zūmo GPS Navigators, Boom!™ Audio Cruiser Amp and Speakers, Mini-Tachs, Digital Oil Pressure Gauges and Heated Grips.

**72673-11** **\$17.95**  
Fits '14-later XL, '12-later Dyna® and '11-later Softail® models.

## F. SWITCHED CIRCUIT ADAPTER HARNESS\*

This harness allows two accessories to be connected to the switched accessory circuit featured on '94-later Touring models. You then may switch two accessories on or off simultaneously as required.

**70264-94A** **\$19.95**  
Fits '94-later Touring and Trike models. Required on '14-later Touring and Trike models when connecting multiple powered accessories using Electrical Connection Kit P/N 69200722.

## G. ELECTRICAL ACCESSORY ADAPTER\*

Harness accommodates the addition of multiple electrical accessories to the main battery power circuit on specific models.

**70270-04** **\$15.95**  
Fits '04-'13 XL, XR and Touring models. Also fits '07-later VRSC™, '04-'11 Dyna and '04-'10 Softail models.



**D. ELECTRICAL CONNECTION UPDATE KIT – TOURING**



**E. ELECTRICAL CONNECTION UPDATE KIT**



**F. SWITCHED CIRCUIT ADAPTER HARNESS**



**G. ELECTRICAL ACCESSORY ADAPTER**

\*NOTE: It is possible to overload your motorcycle's charging system by adding too many electrical accessories. If your combined electrical accessories operating at any one time consume more electrical current than your vehicle's charging system can produce, the electrical consumption can discharge the battery and cause vehicle electrical system damage. Ask your dealer for advice about the amount of current consumed by additional electrical accessories.

Notice: The prices appearing in this catalog are the manufacturer's suggested retail prices. Actual retail prices may vary.



## RUN TO THE RED LINE

Take command of your personal cockpit. A full-featured dash-mount integrated Speedometer/Tachometer will help you keep an eye on your speed and stay in touch with the heartbeat of your bike.



### FUEL/MILES TO EMPTY

Fuel gauge with countdown feature eliminates mileage guesswork.



### ODOMETER/GEAR INDICATOR

Always be in the right gear for the current riding conditions.



### CLOCK

Selectable 12 or 24 hour time is available at a glance.



### TRIPMETER

Selectable A/B display lets you know how far you've been traveling.

GAUGE FACE  
COLOR

SPEED  
POINTER  
COLOR

LCD  
COLOR

TACH  
POINTER  
COLOR



### OVER 600 COLORS

Match your paint color or viewing preference. Individually customize the backlighting, speedometer pointer, tach pointer and display colors with the push of a button.

### PLUG-N-PLAY CONVENIENCE

Combination Speedo/Tach mounts into the stock instrument housing and your dealer will upload your current mileage at time of installation.



# AUDIO & GAUGES 675

Speedometers/Tachometers



**A. COMBINATION ANALOG SPEEDOMETER/TACHOMETER – 5" SPUN ALUMINUM DIAL**



**A. COMBINATION ANALOG SPEEDOMETER/TACHOMETER – 5" BLACK DIAL**



**NEW**

**B. DIGITAL SPEEDOMETER/ANALOG TACHOMETER – 4" SPUN ALUMINUM DIAL**

AUDIO & GAUGES

## COMBINATION SPEEDOMETER/TACHOMETER

Maintain the clean view over the handlebar. This unique Combination Speedometer/Tachometer allows you to monitor engine speed without adding additional handlebar-mounted gauges. The unit mounts in the stock dash opening and is a direct plug-in installation. The backlit gauges include a large LCD (liquid crystal display) information screen that displays odometer/tripmeter data, miles-to-empty readings, an easy-to-read segmented fuel display, a gear position indicator and clock. This valuable information is available to the rider at a glance. The gauge features push-button adjustable backlighting with over 600 color tone options, allowing the rider to adjust pointer, LCD and backlighting colors to match any paint scheme or viewing preference.

NOTE: As a result of different Original Equipment capabilities, the following exceptions apply: Gear position not available on '04-'07 models, Fuel functions are not available on '04-'06 XL, '04-'08 Dyna®, '04-'07 Softail® and '04-'07 Road King®.

## A. ANALOG SPEEDOMETER/TACHOMETER – 5"

Gauges feature speedometer and tachometer pointers that sweep clockwise to provide a "gauge within a gauge" look. Kit includes a data transfer cable to easily upload initial mileage at time of installation.

Fits '04-'11 Dyna, '04-'10 Softail (except FLSTSE) and '04-'13 Road King models (except FLHRSE3/4) equipped with a 5" Speedometer.

<b>70900070A</b>	Spun Aluminum Dial, MPH.	<b>\$314.95</b>
<b>70900071A</b>	Spun Aluminum Dial, km/h.	<b>\$314.95</b>
<b>70900072A</b>	Spun Aluminum Dial, MPH/km/h.	<b>\$314.95</b>

Fits '12-later Dyna, '11-later Softail and '14-later FLHR and FLHRC models with a 5.0" Speedometer (except FLSTSE2/3).

<b>74774-11B</b>	Spun Aluminum Dial, MPH.	<b>\$269.95</b>
<b>74775-11A</b>	Spun Aluminum Dial, km/h.	<b>\$269.95</b>
<b>70900171A</b>	Spun Aluminum Dial, MPH/km/h.	<b>\$269.95</b>
<b>74776-11A</b>	Black Dial, MPH.	<b>\$269.95</b>
<b>74777-11A</b>	Black Dial, km/h.	<b>\$269.95</b>

## B. DIGITAL SPEEDOMETER/ANALOG TACHOMETER – 4"

The digital speed reading can be easily toggled between MPH and kph to simplify cross-border travel. Mileage reinstatement resides in the vehicle ECM so initial mileage will be uploaded at the time of installation.

**70900475** Spun Aluminum Dial, MPH/km/h. **\$314.95**  
U.S. models. Fits '14-later XL, '12-later Dyna and '11-later Softail models equipped with 4" speedometer. XL models require separate purchase of Fuel Sensor Kit P/N 61200008 to make use of the fuel level and range function.

**70900100C** Spun Aluminum Dial, MPH/km/h. **\$314.95**  
Non-U.S. models. Fits '14-later XL, '12-later FXDB and FXDWG, '11-later FXCWC, FXS and FXSB models equipped with 4" speedometer. XL models require separate purchase of Fuel Sensor Kit P/N 61200008 to make use of the fuel level and range function.

**70900274** Spun Aluminum Dial, MPH/km/h. **\$309.95**  
Worldwide models. Fits '04-'13 XL models (except XR, '04-'08 XL1200R and XL50), '04-'11 Dyna models with 4.0" speedometer and '08-'10 FXCW and FXCWC models. '07-'13 XL models require separate purchase of Fuel Sensor Kit P/N 61200008 to make use of the fuel level and range function. Does not fit XL883 models equipped with Screamin' Eagle 1200cc Stage I Conversion Kit P/N 29784-07 and 30003-10.

Also available:

### FUEL LEVEL SENSOR KIT

In-tank sending unit employs capacitive sensing technology to accurately monitor the fuel level and relays the information to the Speedo/Tach LCD display for at-a-glance viewing. Kit includes sending unit, wiring harness and all necessary installation hardware.

**61200008** **\$139.95**  
Fits '07-later XL models equipped with Combination Digital Speedometer/Analog Tachometer P/N 70900274, 70900100C or 70900475.

Model Family Fitment:

- V-ROD
- SPORTSTER
- DYNA
- SOFTAIL
- TOURING

Notice: The prices appearing in this catalog are the manufacturer's suggested retail prices. Actual retail prices may vary.



# 676 AUDIO & GAUGES

## Speedometers/Tachometers

### A. COMBINATION DIGITAL SPEEDOMETER/ANALOG TACHOMETER

Maintain the clean view over the handlebar. This unique Combination Digital Speedometer with radial Analog Tachometer allows you to monitor engine speed without adding a handlebar-mounted tach. The gauge features an easy-to-read digital speedometer within a spun aluminum surface and an analog tachometer that sweeps the perimeter of the face. The digital reading can be easily toggled between MPH and km/h to simplify cross-border travel. The unit mounts in the stock dash opening and is a direct plug-in installation.

**74717-10** **\$309.95**

Fits '08-'10 Softail® models with a 5" speedometer.

**74720-10** **\$309.95**

Fits '08-'13 Road King® models with a 5" speedometer.

**74723-10** **\$309.95**

Fits '09-'11 Dyna® models with 5" speedometer.



**A. COMBINATION DIGITAL SPEEDOMETER/ANALOG TACHOMETER**

### B. COMBINATION DIGITAL SPEEDOMETER/ANALOG TACHOMETER

This unique Digital Speedometer with Radial Tachometer allows you to monitor engine speed without adding a handlebar-mounted tach. The gauge features an easy-to-read digital speedometer within a spun aluminum gauge face and an analog tachometer that sweeps the perimeter of the face. This digital reading can be easily toggled between odometer/tripmeter data, miles-to-empty, clock and MPH or km/h to simplify cross-border travel. The unit mounts in the stock dash opening and is a direct plug-in installation. Mileage reinstatement resides in the vehicle's ECM so initial mileage will be uploaded at the time of gauge installation. Dealer flash required before installation.

**70900001A** **\$309.95**

Fits '11-'14 Softail models with a 5" speedometer. Original equipment on '11-'12 FLSTSE2/3 models. Vehicles without ABS will require a Digital Technician® flash to disable the abs icon.

**70900183** **\$309.95**

Fits '12-'14 FLD, FXDC and FXDF models equipped with a 5" speedometer. Vehicles without ABS will require a Digital Technician flash to disable the ABS icon.



**B. COMBINATION DIGITAL SPEEDOMETER/ANALOG TACHOMETER**

### C. SPUN ALUMINUM FACE SPEEDOMETER

Add a touch of luxury and style to your dash. First featured on the '04 Screamin' Eagle® Deuce™ and Electra Glide® motorcycles, these spun aluminum metal-faced gauges offer a rich contrast to a chrome console or black inner fairing surface. The gauges feature subtle Harley-Davidson® racing orange backlighting for a unique nighttime look. Mileage reinstatement is available through your Dealer.

Fits '04-'06 Dyna FXDWG, Softail and Road King and '06 Dyna FXD35 and '07 FXDC models.

**67313-05A** 5" Speedometer – MPH. **\$204.95**

**67315-05A** 5" Speedometer – km/h. **\$204.95**



**C. SPUN ALUMINUM FACE SPEEDOMETER**

#### Model Family Fitment:

- V-ROD
- SPORTSTER
- DYNA
- SOFTAIL
- TOURING

*Notice: The prices appearing in this catalog are the manufacturer's suggested retail prices. Actual retail prices may vary.*

# AUDIO & GAUGES 677

## Tachometers



**D. 2-5/8" MINI TACH KIT WITH SHIFT LIGHT - BLACK FACE**



**D. 2-5/8" MINI TACH KIT WITH SHIFT LIGHT - SPUN ALUMINUM FACE**

### D. 2-5/8" MINI TACH KITS WITH SHIFT LIGHT

With its attention-grabbing rider-selectable shift light, these chrome-plated, 0-8,000 RPM mini tachometers add style and function. Measuring 2-5/8 inches in diameter, these chrome-plated tachs boast superior illumination and high-quality construction. The hard-coated lens is both fog-and scratch-resistant and is ultrasonically welded to the case, resulting in a strong, reliable seal. Our exclusive, balanced pointer design allows for a quick, precise needle sweep and minimal low idle flutter. Complete wiring, hardware and installation instructions are included. Not for use with Windsplitter Windshields or windshield bags.

Fits XL, Dyna®, Softail® and Road King® models equipped with appropriate 2-5/8" Mini Tach Mounting Bracket.

<b>69828-06</b>	Spun Aluminum Face.	<b>\$249.95</b>
<b>69829-06</b>	Black Face.	<b>\$249.95</b>

### E. MINI TACH TAPERED GAUGE HOUSING

Housing features a "tapered look" to dress up the Mini Tach for a sleek appearance. Easy replacement for the original Mini Tach gauge housing.

**67524-04** **\$29.95**

Fits models equipped with 2-5/8" Mini Tach and appropriate mounting bracket.

### F. BILLET MINI TACH MOUNT - FL NACELLE

Chrome-plated aircraft quality aluminum Mini Tach Mount adds a custom addition to your Road King model. Scalloped lower edge assembles directly to your stock handlebar clamp cover, for a one-piece look. Add the appropriate 2-5/8" Mini Gauge and gauge housing (sold separately) to complete the custom look.

**68961-98A** **\$119.95**

Fits '94-'13 FLHR models. Also fits '86-'11 FL Softail models equipped with Freight Train Headlight Nacelle. (Does not fit with Fat Handlebars or Beach Bars.)

### G. 2-5/8" MINI TACH MOUNTING BRACKETS

Polished and plated to a brilliant shine, these steel brackets are designed to mount a 2-5/8" Mini Gauge at the ideal viewing angle. Gauge installation requires separate purchase of Gauge Housing.

**1. 67268-06B** **\$74.95**

Fits '06-'11 FXDWG, '08-'11 FXDF, '07-'10 FXSTC and '09-'10 FLSTC models. Will not fit models equipped with one-piece handlebar with integrated risers, models equipped with Headlamp Mount Micro Gauges, Road Tech™ Electronic Compass, Road Tech Radio or Windshield Bags.

**2. 68150-05** **\$59.95**

Fits '05-'10 FLSTN and '08-'11 FXDB models.

**3. 67206-04** **\$59.95**

Fits '96-'05 FXDWG, '06-'07 FXDB, '06 FXD35, '07-'11 FXDC, '86-'06 FLSTF, '86-'08 FLSTC, '93-'96 FLSTN and '00-'09 FXSTB models. Will not fit models equipped with one-piece handlebar with integrated risers, models equipped with Headlamp Nacelle Kit, models equipped with Handlebar Mount Micro Gauges, Road Tech Electronic Compass, Road Tech Radio or Windshield Bags.

**4. 67231-04A** **\$69.95**

Fits '94-'13 FLHR models (except FLHRSEI or FLHRS). Also fits '86-'10 FL Softail models equipped with Freight Train Headlight Nacelle. (Does not fit with Fat Handlebars and Beach Bars.)

**5. 69426-04** **\$49.95**

Fits '07-later XL Custom models. Not for use with Windshield Bags.



**E. MINI TACH TAPERED GAUGE HOUSING**



**F. BILLET MINI TACH MOUNT - FL NACELLE**



**G. 2-5/8" MINI TACH MOUNTING BRACKETS**



# 678 AUDIO & GAUGES

## Gear Indicator & Gauges

### A. DIGITAL GEAR INDICATOR

What gear are you in right now? Eliminate the guesswork with a Digital Gear Indicator. Conveniently located on the handlebar for line-of-sight viewing, the bright LED display is easy to read with a quick glance. When the clutch is "out," the display indicates the current gear 1-6 or a large "N" when the transmission is in the neutral position. Easy to install, this plug & play Gear Indicator requires no wire splicing or complicated programming. A built-in photocell automatically adjusts the display for improved visibility in direct sunlight and dims the display at night to reduce distraction. Available in chrome or satin black finish to match your styling direction. The complete kit includes a self-contained LED and control module, control housing, wiring harness and required mounting hardware. Switch housing can accept one additional auxiliary switch (sold separately).

Fits '07-later VRSC™ (except VRSCF), '07-'13 XL and XR, '07-'13 Touring, '07-'11 Dyna® and '07-'10 Softail® models. '07-'08 XL1200 models require update calibration. Does not fit XL883 models equipped with Screamin' Eagle® 1200CC Stage I Conversion Kits P/N 29784-07 and 30003-10. Also, does not fit with Boom!™ Audio Cruiser Amp and Speaker Kits P/N 76262-08, 76320-08 or 76321-09.

<b>70900038</b>	Chrome.	<b>\$219.95</b>
<b>70900078</b>	Black.	<b>\$219.95</b>



A. DIGITAL GEAR INDICATOR – CHROME



A. DIGITAL GEAR INDICATOR – BLACK

### B. TACH KIT FOR SPORTSTER® MODELS

Upgrade your XL883 to dual instruments. The kit includes an electronic tachometer, wrinkle-black dual gauge mounting bracket and hardware required for installation. Tachometer graphics complement Original Equipment speedometer and brackets allow for installation of your stock indicator lights.

**67182-07** **\$336.95**  
Fits '07-'08 XL883 STD, '07-'10 XL883L and '07-later XL883R models. Stock on '07-'08 XL1200R models.

**67182-04** **\$299.95**  
Fits '04-'06 XL883 STD, XL883L and XL883R models. Stock on '04-'06 XL1200R. Use with accessory Handlebar Clamp requires separate purchase of (2) Screw P/N 3485A and (2) Spacer P/N 5775.



B. TACH KIT FOR SPORTSTER MODELS



C. GAUGE BRACKET KITS – CHROME

### C. GAUGE BRACKET KITS – CHROME

#### 1. Speedometer/Tachometer

Kit includes chrome dual gauge mounting bracket and chrome speedometer and tachometer backplates.

**67294-95A** **\$114.95**  
Fits '99-'05 FXDX and '01-'03 FXDXT, '95-'04 FXDS-CONV. and '95-'10 XL1200 models (except XL1200C, XL1200N, XL1200V, XL1200L and XL1200X). Will also fit '95-later XL883, XL-Deluxe and Hugger™ and FXD Super Glide® models that have been upgraded to dual gauges. '04-'10 FXD models require accessory handlebar clamps and separate purchase of two Screw P/N 3485A and two Spacer P/N 5775.

#### 2. Speedometer

Replace the stock wrinkle black components. Kit includes chrome speedometer mounting bracket and backplate.

**67293-95** **\$114.95**  
Fits '95-'10 XL883 and '95-'10 FXD Super Glide models equipped with single gauge. '04-'10 FXD models require accessory handlebar clamps and separate purchase of two Screw P/N 3485A and two Spacer P/N 5775.

### D. OIL PRESSURE AND AIR TEMP GAUGE KIT FOR FLHT MODELS

This kit finishes the instrument console on the Electra Glide® Standard model. Complete with all necessary brackets and hardware.

**74439-00** Fits '00-'10 FLHT models. **\$144.95**



D. OIL PRESSURE AND AIR TEMP GAUGE KIT FOR FLHT MODELS

Notice: The prices appearing in this catalog are the manufacturer's suggested retail prices. Actual retail prices may vary.

# AUDIO & GAUGES 679

## Oil Pressure Gauges



**E. DIGITAL OIL PRESSURE GAUGE – CHROME**



### E. DIGITAL OIL PRESSURE GAUGE

Keep an eye on your engine's vital signs. This Oil Pressure Gauge features a brilliant blue, easy-to-read digital display that shines through a mirror-coated glass when the ignition is turned on. The readout is invisible when not in use. A photocell automatically adjusts the display's brightness to improve visibility in direct sunlight or to dim the display at night to avoid distraction. The display can be toggled between PSI and BAR pressure readings. Kit includes die-cast mounting bracket with gauge, pressure sensor and wiring harness.

Fits '99-later Dyna®, '00-later Softail®, '99-later Road King®, Electra Glide® Standard and Freewheeler™ models. Also fits '99-later Electra Glide Classic, Ultra Classic®, Limited and Tri Glide models if original oil pressure gauge is disconnected. Does not fit with Billet Rocker Box Covers P/N 17658-03, Burst Rocker Box Covers P/N 25700251, Mid-Frame Air Deflectors P/N 58022-07A or 58170-09 or models equipped with Sidecars. '12-later Dyna and '11-later Softail models require separate purchase of Electrical Connection Kit P/N 72673-11. '14-later Touring models require separate purchase of Electrical Connection Kit P/N 69200722.

<b>75138-09</b>	Chrome.	<b>\$249.95</b>
<b>75340-09</b>	Gloss Black.	<b>\$249.95</b>

### F. LIQUID-FILLED OIL PRESSURE GAUGE

Contains special non-yellowing fluid that dampens the internal movement for improved gauge reliability. Incorporates corrosion-resistant stainless steel bezel and includes Harley-Davidson® Bar & Shield graphics that match various late model instruments. Complete with chrome-plated steel fittings and O-rings for crankcase installation. New mounting design prevents damage from improper installation.

<b>75012-82D</b>		<b>\$59.95</b>
Fits '82-'84 Shovelhead and '84-later Evolution® 1340-equipped models.		



**E. DIGITAL OIL PRESSURE GAUGE – GLOSS BLACK**



**F. LIQUID-FILLED OIL PRESSURE GAUGE**

### G. OIL PRESSURE GAUGE KIT

Check your oil pressure at a glance with this oil-filled Pressure Gauge Kit, specifically designed to look good, fit right and perform properly on your Twin Cam-equipped motorcycle. The custom mounting brackets have been polished and chrome-plated to rigid Harley-Davidson standards and the gauge offers premium reliability. The kit includes all necessary hardware and mounting brackets for quick and clean installation.

<b>75133-99</b>		<b>\$99.95</b>
Fits '99-'05 Dyna, '00-later Softail, '99-'13 FLHR and '99-'05 FLHT models. Does not fit with Billet Rocker Box Cover P/N 17658-03.		



**G. OIL PRESSURE GAUGE KIT**



#### Model Family Fitment:

 V-ROD	 SPORTSTER	 DYNA
 SOFTAIL	 TOURING	

*Notice: The prices appearing in this catalog are the manufacturer's suggested retail prices. Actual retail prices may vary.*



# 680 AUDIO & GAUGES

## Fairing Mount Gauges

### A. CUSTOM FACE GAUGES

Add a rich, custom look to your dash. First featured on the '14-'15 CVO™ models, these chrome-accented gauges feature LED backlighting and large, easy-to-read numbers for at-a-glance viewing. Gauges are plug-in ready and require no additional splicing or re-wiring for installation. Mileage reinstatement is available through your Dealer.

Fits '14-later Electra Glide®, Road Glide®, Street Glide® and Tri Glide® models. Original Equipment on CVO models.

<b>70900293A</b>	Speedo/Tach Cluster – MPH.	<b>\$299.95</b>
<b>70900294</b>	Speedo/Tach Cluster – km/h.	<b>\$299.95</b>
<b>70900295</b>	Speedo/Tach Cluster – MPH/km/h.	<b>\$299.95</b>
<b>70900296</b>	Fuel Gauge.	<b>\$99.95</b>
<b>70900297</b>	Voltmeter.	<b>\$99.95</b>

### B. SPUN ALUMINUM FACE GAUGES

Add a touch of luxury and style to your dash. First featured on the '04 Screamin' Eagle® Deuce™ and Electra Glide models, these Spun Aluminum Face Gauges offer a rich contrast to a chrome console or black inner fairing surface. The gauges feature subtle Harley-Davidson® racing orange backlighting for a unique nighttime look. Mileage reinstatement is available through your Dealer.

**67516-08** 4" Speedometer – MPH. **\$204.95**  
Fits '08-'13 Electra Glide and Road Glide models equipped with 4" gauges.

**67516-04B** 4" Speedometer – MPH. **\$204.95**  
Fits '04-'07 Electra Glide and Road Glide models equipped with 4" gauges.

**67522-04B** 4" Tachometer. **\$246.95**  
Fits '04-'13 Electra Glide and Road Glide models and '04-later XL and Dyna® models equipped with 4" gauges.

**74552-04A** Voltmeter. **\$89.95**  
Fits '04-'13 Electra Glide, Road Glide and Trike models.

**75113-04A** Fuel Gauge. **\$89.95**  
Fits '04-'07 Electra Glide and Road Glide models.

**75113-08** Fuel Gauge. **\$89.95**  
Fits '08-'13 Electra Glide and Road Glide models.

**74553-04A** Oil Pressure Gauge. **\$89.95**  
Fits '04-'13 Electra Glide, Road Glide and Trike models. FLHT/I models require purchase of additional service parts for installation. See your Dealer for details.

**74554-04** Air Temperature Gauge. **\$54.95**  
Fits '04-'13 Electra Glide, Road Glide and Trike models. FLHT/I models require purchase of additional service parts for installation. See your Dealer for details.

### C. TITANIUM FACE GAUGES

Add a rich, custom look to your dash. First featured on the '10 FLHTK Ultra Limited model, these black and icy cool "titanium" numbered gauges feature white LED backlighting and large, easy-to-read numbers for at-a-glance viewing. Gauges are plug-in ready and require no additional splicing or re-wiring for installation. Mileage reinstatement is available through your Dealer.

Fits '08-'13 Touring (except Road King®) and Trike models.

**74682-10** 4" Speedometer – MPH. **\$189.95**

**74683-10** 4" Speedometer – km/h. **\$189.95**

**74692-10** 4" Tachometer. **\$159.95**

**74688-10** Fuel Gauge. **\$69.95**

**74689-10** Air Temperature Gauge. **\$69.95**

**74690-10** Oil Pressure Gauge. **\$69.95**

**74691-10** Voltmeter. **\$69.95**

**70900176** Oil Temperature – Fahrenheit. **\$149.95**

**70900193** Oil Temperature – Celsius. **\$149.95**

#### Model Family Fitment:

<span style="display: inline-block; width: 10px; height: 10px; background-color: #cccccc; border: 1px solid #000;"></span> V-ROD	<span style="display: inline-block; width: 10px; height: 10px; background-color: #ffcc00; border: 1px solid #000;"></span> SPORTSTER	<span style="display: inline-block; width: 10px; height: 10px; background-color: #ff0000; border: 1px solid #000;"></span> DYNA
<span style="display: inline-block; width: 10px; height: 10px; background-color: #4b0082; border: 1px solid #000;"></span> SOFTTAIL	<span style="display: inline-block; width: 10px; height: 10px; background-color: #008080; border: 1px solid #000;"></span> TOURING	

*Notice: The prices appearing in this catalog are the manufacturer's suggested retail prices. Actual retail prices may vary.*

NEW



A. CUSTOM FACE GAUGES



B. SPUN ALUMINUM FACE GAUGES



C. TITANIUM FACE GAUGES

# AUDIO & GAUGES 681

## Fairing Mount Gauges & Gauge Trim



**C. OIL TEMPERATURE GAUGE – FAIRING MOUNT**

### C. OIL TEMPERATURE GAUGE – FAIRING MOUNT

Keep a close eye on your engine's vital signs. This 2.0" diameter gauge monitors engine oil temperature to provide an early warning of conditions that may require attention. The gauge face is styled to complement Original Equipment fairing mount gauges. Complete kit includes gauge, installation hardware and wiring harness.

Fits '99-'13 FLHT, FLHTC, FLHTCU, FLHX, FLTR and Trike models. Does not fit '09-later CVO™ models.

<b>1. 70900284</b>	Silver Face – Fahrenheit.	<b>\$149.95</b>
<b>2. 70900283</b>	Black Face – Fahrenheit.	<b>\$149.95</b>

Fits '08-'13 Touring models (except Road King®) and Trike models.

<b>3. 70900176</b>	Titanium Face – Fahrenheit.	<b>\$149.95</b>
<b>70900193</b>	Titanium Face – Celsius.	<b>\$149.95</b>

### D. DIAMOND ICE GAUGE TRIM RINGS

These Gauge Trim Rings add a fine line of rhinestones around the perimeter of the gauge face and a deluxe finishing touch to the dash. Chrome-plated steel rings feature adhesive backing for easy press-in-place installation.

**74548-10** 5.0" Gauge. **\$29.95**

Fits '99-'08 FXDWG, '99-later FXDF, FLD, '07-later FXDC, '99-'07 Road King and '99-later Softail® models (except FXS, FXSB, FXSBSE, FXSTD, FXCW, FXCWC, FLSTFSE, FLSTNSE, FXST-Aus and Softail models equipped with chrome Console P/N 67575-04 or 71208-07).

**74736-10** 4.0" Gauge. **\$28.95**

Fits speedometers and tachometers on '05-'06 FXDC, '10-later FXDWG, '00-later XL, FXDL, FXDB, FXD, FXS, '13 FXSB, FXSBSE and '00-'13 Electra Glide®, Street Glide®, Road Glide® and Trike models. Sold individually.

**74737-10** 2.0" Gauge. **\$23.95**

Fits Voltmeter, Oil Pressure, Air Temp and Fuel Gauge on '86-'13 Electra Glide, Street Glide, Road Glide and Trike models. Sold individually.



**D. DIAMOND ICE TRIM RING – 5" GAUGE**



### E. GAUGE VISOR RING

A touch of chrome makes all the difference. These easy-to-install trim rings feature an integrated eyebrow visor to shield the gauge face from the sun's glare. Self-adhesive backing for secure mount.

**74661-04** 5.0" Gauge. **\$27.95**

Fits '99-'08 FXDWG, '99-'07 Road King and '99-later Softail models (except FXS, FXSB, FXSBSE, FLSTNSE, FXST-Aus, FXSTD, FXCW, FXCWC, FLSTFSE and Softail models equipped with Chrome Console P/N 67575-04).

**74662-04** 4.0" Gauge. **\$25.95**

Fits '99-later XL, '99-'13 Dyna® (except FXDWG), FXS, FXSB, FXSBSE, FXST-Aus and '98-'13 Road Glide models.

### F. INSTRUMENT GAUGE BEZEL

This chrome-plated gauge bezel installs easily to add subtle style to your instruments.

**74541-00** 4.0" Gauge. **\$16.95**

Fits Speedometer and Tachometer Gauges on '00-later XL, '00-'13 Dyna (except FLD and FXDWG), '13 FXSB, FXSBSE and FXST-Aus and '00-'13 Electra Glide, Street Glide, Road Glide and Trike Models (sold individually).



**E. GAUGE VISOR RING – 5" GAUGE**



**F. INSTRUMENT GAUGE BEZEL – 4" GAUGE**

### G. BILLET ANALOG CLOCK

Housed in a billet aluminum case, this unique Analog Clock provides a simple solution to telling time on the road. Strong double-sided tape attaches this water-resistant clock to any flat surface. The available chrome or black finish complements the controls on your bike.

Mounts to flat surfaces. Fits master cylinder housing on many models. Not for use with Auxiliary Accessory Switch Housing Kits.

**75055-03** Chrome Finish. **\$59.95**

**75054-03** Black Finish. **\$59.95**



**G. BILLET ANALOG CLOCK – CHROME FINISH**



**G. BILLET ANALOG CLOCK – BLACK FINISH**

*Notice: The prices appearing in this catalog are the manufacturer's suggested retail prices. Actual retail prices may vary.*



# 682 AUDIO & GAUGES

## Oil Temp & Level

### A. OIL LEVEL AND TEMPERATURE DIPSTICK WITH LIGHTED LCD READOUT

New and improved "capacitive" level sensing technology provides the highest degree of accuracy and durability. Now available in chrome and black, these dipsticks allow you to check your oil level and oil temperature with the push of a button. Add function and style by replacing your stock dipstick with this hard working version. No more grabbing a rag to pull your hot dipstick. No more oil drips on your pipes and on the garage floor. Simply push the button and this dipstick lights up with a brilliant backlight. Oil level is indicated by a four-segment readout – it even reminds you to check your oil when it is hot. Designed to be waterproof, the LCD (liquid crystal display) readout operates on a long-lasting, replaceable lithium coin-type battery (CR2032 3V, P/N 66000107). Display features a low battery indicator and press-and-hold feature to toggle between Fahrenheit and Celsius.

Fits '06-later Dyna® models (except FLD).

<b>62974-09</b>	Chrome.	<b>\$149.95</b>
<b>63065-09</b>	Black.	<b>\$149.95</b>

Fits '00-later Softail® models (except FXCW, FXCWC, FXSB, FXSBSE and FXSTSSE3).

<b>62955-09</b>	Chrome.	<b>\$149.95</b>
<b>63055-09</b>	Black.	<b>\$149.95</b>

Fits '08-later FXCW, FXCWC, FXSB, FXSBSE and FXSTSSE3 models.

<b>63002-09</b>	Chrome.	<b>\$149.95</b>
-----------------	---------	-----------------

Fits '07-later Touring models (except models equipped with a Sidecar). Will not fit Touring models equipped with Engine/Transmission Interface Cover P/N 66532-07.

<b>63004-09</b>	Chrome.	<b>\$149.95</b>
<b>63030-09</b>	Black.	<b>\$149.95</b>

Fits '02-'06 Touring models (except models equipped with a Sidecar). Also fits '99-'01 Touring models equipped with Chrome Oil Filler Spout P/N 62470-02, 62453-02 or 62454-02A.

<b>62946-09</b>	Chrome.	<b>\$149.95</b>
-----------------	---------	-----------------

Fits '04-later XL and XR models.

<b>62700009</b>	Chrome.	<b>\$149.95</b>
<b>62700011</b>	Gloss Black.	<b>\$149.95</b>

Fits '09-later Trike models. Also fits '09-later Touring models equipped with a sidecar.

<b>62700005</b>	Chrome.	<b>\$149.95</b>
-----------------	---------	-----------------

**Also available:**

<b>66000107</b>		<b>\$3.95</b>
-----------------	--	---------------

CR2032 3V Lithium Replacement Battery.



**A. OIL LEVEL AND TEMPERATURE DIPSTICK – CHROME (DYNA SHOWN)**



**A. OIL LEVEL AND TEMPERATURE DIPSTICK – BLACK (DYNA SHOWN)**



**A. OIL LEVEL AND TEMPERATURE DIPSTICK – CHROME (SPORTSTER SHOWN)**



**A. OIL LEVEL AND TEMPERATURE DIPSTICK – BLACK (SOFTAIL SHOWN)**

### B. OIL DIPSTICK WITH TEMPERATURE GAUGE

Replace your Original Equipment oil dipstick with this custom-styled version featuring an easy-to-see mechanical temperature readout with "Harley-Davidson" logo. A chrome-plated cap completes the styling and provides an easy grip for removal.

<b>62896-00B</b>		<b>\$39.95</b>
------------------	--	----------------

Fits '00-later Softail models (except FXCW, FXCWC, FXSB, FXSBSE and FXSTSSE3).

<b>62668-87TA</b>	Fits '84-'99 Softail models.	<b>\$34.95</b>
-------------------	------------------------------	----------------

<b>63023-05</b>	Fits '04-later XL and XR models.	<b>\$59.95</b>
-----------------	----------------------------------	----------------

<b>62667-87TA</b>	Fits '82-'03 XL models.	<b>\$34.95</b>
-------------------	-------------------------	----------------



**B. OIL DIPSTICK WITH TEMPERATURE GAUGE (SOFTAIL SHOWN)**



**B. OIL DIPSTICK WITH TEMPERATURE GAUGE ('04-LATER SPORTSTER SHOWN)**

*Notice: The prices appearing in this catalog are the manufacturer's suggested retail prices. Actual retail prices may vary.*

# AUDIO & GAUGES 683

Clocks & Air Temp



C. HANDLEBAR CLOCK – 1.75" BLACK



C. HANDLEBAR CLOCK – 1.75" CHROME



C. HANDLEBAR CLOCK – 1.5" BLACK/CHROME



C. HANDLEBAR CLOCK – 1.5" SILVER/CHROME



D. HANDLEBAR THERMOMETER – 1.5" BLACK



D. HANDLEBAR THERMOMETER – 1.5" SILVER



E. HANDLEBAR MOUNT CLAMP – CHROME



E. HANDLEBAR MOUNT CLAMP

## C. HANDLEBAR CLOCK

Arrive on time without looking at your watch. These large diameter battery-powered analog clocks are easy to read at a glance and are available in your choice of chrome or black finish to complement your styling direction. Designed to mount to the clutch lever bracket, the waterproof clock is powered by a self-contained replaceable battery that makes installation a breeze. Kit includes clutch lever mounting bracket, but if you need to mount the clock on another area of the handlebar, select from the available Handlebar Clock Mount Clamps (sold separately).

Fits all models (except '15-later XG). Models equipped with reverse switch or Auxiliary Accessory Switch Housing Kits will require separate purchase of appropriate Handlebar Clock Mount Clamp.

<b>70900307</b>	1.75" Chrome.	<b>\$79.95</b>
<b>70900308</b>	1.75" Black.	<b>\$79.95</b>
<b>75041-03</b>	1.5" Black/Chrome.	<b>\$59.95</b>
<b>75042-03</b>	1.5" Silver/Chrome.	<b>\$59.95</b>

## D. HANDLEBAR THERMOMETER

Designed to mount to the Brake Master Cylinder Clamp, this polished stainless steel temperature gauge will keep you in touch with the outside air temperature. Styled to match the Original Equipment gauge design and the Clutch Lever Bracket Clamp Clock, the thermometer is available with black or silver face. This waterproof gauge is simple to install. Kit includes clutch lever mounting bracket, but if you need to mount the clock on another area of the handlebar, select from the available Handlebar Clock Mount Clamps (sold separately).

Fits all models (except '15-later XG). Not for use with Auxiliary Accessory Switch Housing Kits.

<b>75102-04</b>	1.5" Black, Fahrenheit.	<b>\$59.95</b>
<b>75104-04</b>	1.5" Silver, Fahrenheit.	<b>\$59.95</b>
<b>75108-06</b>	1.5" Black, Celsius.	<b>\$69.95</b>
<b>75115-06</b>	1.5" Silver, Celsius.	<b>\$69.95</b>

## E. HANDLEBAR MOUNT CLAMP

Position your Handlebar Clock or Temperature Gauge for quick and comfortable viewing. Custom hinged clamp firmly grips the handlebar and locks the clock or temperature gauge into position. Easy to install at your choice of location along the bar, this clamp provides an alternative mounting position if the handlebar control clamp bracket is occupied by other accessories like zūmo® GPS Navigator, Boom!™ Audio Cruiser Amp & Speaker Kit, Gear Indicators or Auxiliary Switch Housings.

Fits all models with 1 inch handlebars.

<b>10800055</b>	1.0" Chrome.	<b>\$21.95</b>
<b>10800057</b>	1.0" Black.	<b>\$21.95</b>

Fits all models with 1.25 inch handlebars.

<b>10800056</b>	1.25" Chrome.	<b>\$21.95</b>
<b>10800058</b>	1.25" Black.	<b>\$21.95</b>

### Model Family Fitment:

V-ROD	SPORTSTER	DYNA
SOFTAIL	TOURING	

Notice: The prices appearing in this catalog are the manufacturer's suggested retail prices. Actual retail prices may vary.



# 684 AUDIO & GAUGES

## Fuel Caps & Gauges

### A. LED FUEL GAUGES\*

This low-profile fuel gauge replaces the analog readout with bright LED lamps. The six edge-mounted LED lamps glow blue when the tank is full and extinguish one by one as fuel is consumed. Plug-in installation without splicing. Photocell automatically adjusts LED brightness for improved visibility in direct sunlight and dims at night to avoid distraction.

Fits '09-later Dyna® (except FXD), '08-later Softail® (except FLSTNSE, FXCW, FXCWC, FXS, FXSB and FXSBSE), '08-later Road King® and '15-later Freewheeler™ models.

<b>75098-08A</b>	Skull.	<b>\$169.95</b>
<b>70900354</b>	Chisel.	<b>\$179.95</b>
<b>75358-10A</b>	Diamond Black.	<b>\$149.95</b>
<b>70900265</b>	Diamond Ice.	<b>\$174.95</b>
<b>75242-08A</b>	Smooth.	<b>\$149.95</b>
<b>75051-08A</b>	Bar & Shield Logo.	<b>\$139.95</b>

Fits '04-'08 FXDB, FXDL, FXD35, FXDWG and FXDF, '07-'08 FXDC, '04-'07 Softail, '01-'03 EFI Softail (except FXSTD1), '03-'07 Road King and '01-'02 EFI Road King models.

<b>75095-05B</b>	Skull.	<b>\$169.95</b>
<b>75357-10A</b>	Diamond Black.	<b>\$149.95</b>
<b>70900264</b>	Diamond Ice.	<b>\$174.95</b>
<b>75237-03C</b>	Smooth.	<b>\$139.95</b>
<b>75084-04C</b>	Bar & Shield Logo.	<b>\$159.95</b>

\*Some local regulations prohibit using colored lights during vehicle operation on public streets. May not conform to local lighting regulations.

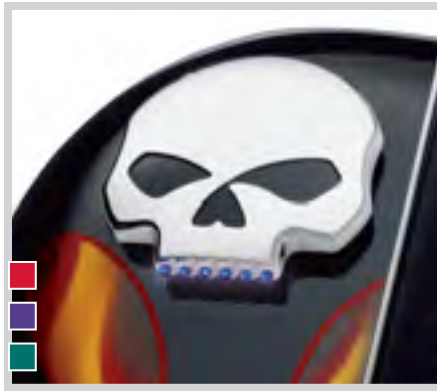

A. LED FUEL GAUGE – SKULL



A. LED FUEL GAUGE – CHISEL



A. LED FUEL GAUGE – DIAMOND BLACK



A. LED FUEL GAUGE – DIAMOND ICE



A. LED FUEL GAUGE – SMOOTH



A. LED FUEL GAUGE – BAR & SHIELD LOGO



Notice: The prices appearing in this catalog are the manufacturer's suggested retail prices. Actual retail prices may vary.

# AUDIO & GAUGES 685

Fuel Caps & Gauges

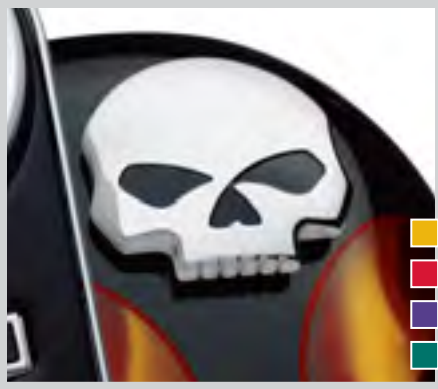

**B. FUEL CAP – SKULL**



**C. FUEL CAP – CHISEL**

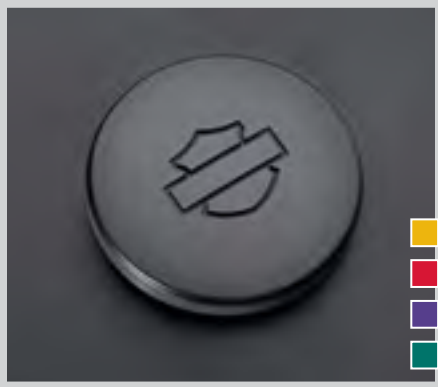

**C. FUEL CAP – DIAMOND BLACK**



**C. FUEL CAP – DIAMOND ICE**



**C. FUEL CAP – CHROME FLAMES**



**C. FUEL CAP – MIDNIGHT FLAMES**



**D. BAR & SHIELD LOGO SELF-LOCKING FUEL CAP**



## B. FUEL CAP – SKULL

Add a little attitude to your ride. Styled to complement Harley-Davidson® Skull accessory items, the menacing raised skull with black-filled eyes features a rich chrome-plated finish and a styled shape that is easy to grip, even while wearing gloves.

**75097-05 \$49.95**

Fits '92-later XL and Dyna® (except '04-later FXD, FXDX, '05-'06 FXDC and '07 FXDSE), '00-later Softail® (except FXSTD, FXSTSSE/2), '94-later Road King® and '15-later Freewheeler™ models. Does not fit models equipped with Original Equipment locking or tethered fuel caps or Softail models with Low-Profile Chrome Fuel Tank Console P/N 71208-07. Use on FXSBSE requires removal of stock flush mount trim ring.

## C. CUSTOM FUEL CAPS

Add a custom touch to your tank. Styled to reflect your attitude, these elegantly constructed fuel caps are the perfect match for your ride. The fuel cap is easy to install and features a ratcheting design to ensure that the design faces the correct direction.

Fits '92-later XL and Dyna (except '04-later FXD, FXDX, '05-'06 FXDC and '07 FXDSE), '00-later Softail, '94-later Road King and '15-later Freewheeler models. Does not fit models equipped with Original Equipment locking or tethered fuel caps. Use on FXSBSE requires removal of stock flush mount trim ring.

<b>61100038</b>	Chisel.	<b>\$69.95</b>
<b>62778-10</b>	Diamond Black.	<b>\$49.95</b>
<b>61100024</b>	Diamond Ice.	<b>\$84.95</b>
<b>75176-08</b>	Chrome Flames.	<b>\$49.95</b>
<b>75343-10</b>	Midnight Flames.	<b>\$49.95</b>

## D. BAR & SHIELD LOGO SELF-LOCKING FUEL CAP

Functional and stylish, these polished, chrome-plated caps feature a convenient self-locking mechanism and a stamped Harley-Davidson Bar & Shield logo on the key hole cover. Maintains the same features as the Original Equipment fuel cap. The kits come complete with two keys.

**62803-97A \$54.95**

Fits '92-later XL and Dyna (except '04-later FXD, FXDX and '05-'06 FXDC and FXDSE), '00-later Softail (except FXS), '94-later Road King and '15-later Freewheeler models. Also fits '99-'00 FXR models. Does not fit models equipped with Original Equipment locking or tethered fuel caps. Use on FXSBSE requires removal of stock flush mount trim ring.

### Model Family Fitment:

V-ROD	SPORTSTER	DYNA
SOFTAIL	TOURING	

Notice: The prices appearing in this catalog are the manufacturer's suggested retail prices. Actual retail prices may vary.



# 686 AUDIO & GAUGES

## Fuel Caps & Gauges

### A. FLUSH-MOUNT FUEL CAP AND GAUGE KIT\*

Emphasize the long and lean look of the fuel tank. This Flush-Mount Fuel Cap and Gauge Kit offers a pop-up filler design that when installed and sealed looks identical to the flush gauge. A simple push and the fuel filler cap pops up to provide ample grip, even while wearing gloves. The flush fuel gauge features individual LED lamps that shine through a mirror-coated glass that glows when the ignition is switched on. A photocell automatically adjusts LED brightness for improved visibility in direct sunlight and dims at night to avoid distraction. Complete kit includes fuel cap, fuel gauge, trim ring and plug-in wiring harness.

Fits '09-later Dyna® models (except FXD).

**62910-09C** Chrome. **\$209.95**

**75327-09C** Gloss Black. **\$209.95**

Fits '04-'08 FXDL, FXDB, FXD35, FXDWG and '07-'08 FXDC and FXDF models.

**62910-06C** Chrome. **\$209.95**

Fits '08-later Softail® (except FLSTNSE, FXCW, FXCWC, FXSB, FXSBSE and FXS), '08-later Road King® and '15-later Freewheeler™ models.

**62823-08C** Chrome. **\$209.95**

**75027-08C** Gloss Black. **\$209.95**

Fits '08-later FXCW and FXCWC models.

**62811-08C** Chrome. **\$209.95**

**75020-08C** Gloss Black. **\$209.95**

Fits '04-'06 carbureted and '01-'07 fuel injected Softail models (except FXSTD/I).

**62818-06F** Chrome. **\$209.95**

**75014-06C** Gloss Black. **\$209.95**

Fits '04-'07 Road King models.

**62823-06C** Chrome. **\$209.95**

\*Some local regulations prohibit using colored lights during vehicle operation on public streets. May not conform to local lighting regulations.



A. FLUSH-MOUNT FUEL CAP AND GAUGE KIT – CHROME



A. FLUSH-MOUNT FUEL CAP AND GAUGE KIT – GLOSS BLACK



A. FLUSH-MOUNT FUEL GAUGE – FULL



A. FLUSH-MOUNT FUEL CAP – GLOSS BLACK

Notice: The prices appearing in this catalog are the manufacturer's suggested retail prices. Actual retail prices may vary.

# AUDIO & GAUGES 687

Fuel Caps & Gauges



**B. FLUSH-MOUNT FUEL CAP – GLOSS BLACK**

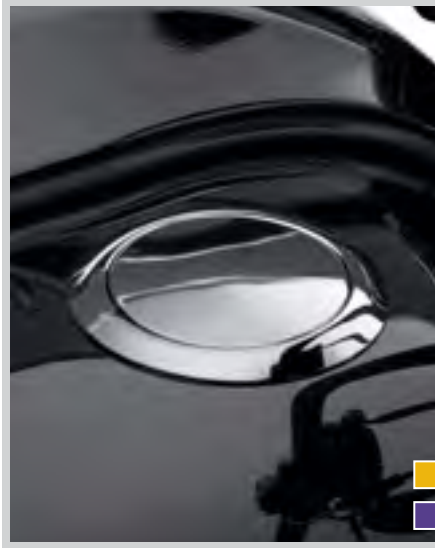

**B. FLUSH-MOUNT FUEL CAP – CHROME**

## B. FLUSH-MOUNT FUEL CAPS

Emphasize the long and lean look of the fuel tank. This Flush-Mount Fuel Cap Kit offers a pop-up filler design that replaces the Original Equipment twist-on fuel cap. A simple push and the fuel filler cap pops up to provide ample grip, even while wearing gloves. Easy to install, the cap assembly screws into position and the self-adhesive decorative ring finishes the look. Complete kit includes screw-in mount, pop-up cap and matching trim ring.

Fits '98-later XL models equipped with 3.3 gal (12.5 L) fuel tank.

<b>63133-10A</b>	Chrome.	<b>\$79.95</b>
<b>63134-10A</b>	Gloss Black.	<b>\$79.95</b>

Fits '98-later XL models equipped with 2.1 gal (7.9 L) or 4.5 gal (17.0 L) fuel tank. Does not fit '04-'10 XL1200C models.

<b>63139-10A</b>	Chrome.	<b>\$79.95</b>
<b>63140-10A</b>	Gloss Black.	<b>\$79.95</b>

Fits '11-later FLSTNSE, FXS, FXSB and FXSBSE models.

<b>61100007A</b>	Gloss Black.	<b>\$79.95</b>
<b>61100006A</b>	Chrome.	<b>\$79.95</b>

## C. BILLET FUEL CAP

Set your gas tank apart from the rest. These machined Billet Fuel Caps feature a rich chrome-plated finish and a styled shape that is easy to grip, even while wearing gloves.

Fits '92-later XL and Dyna® (except '04-later FXD, FXDX and '05-'06 FXDC and FXDSE), '00-later Softail® (except FXS), '94-later Road King® and '15-later Freewheeler™ models. Also fits '99-'00 FXR models. Does not fit models equipped with Original Equipment locking or tethered fuel caps. Use on FXSBSE requires removal of stock flush mount trim ring.

<b>62816-03</b>	Cross.	<b>\$49.95</b>
<b>62819-03</b>	Six Shooter.	<b>\$49.95</b>

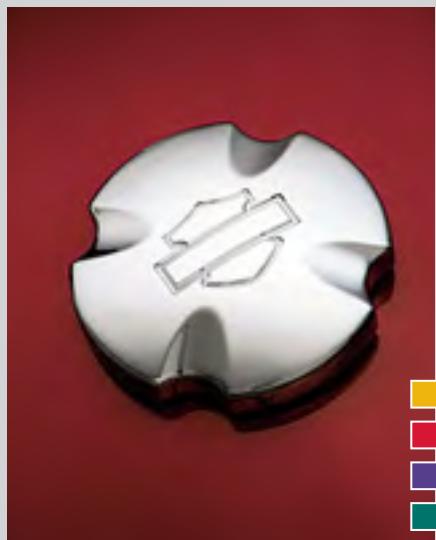

**C. BILLET FUEL CAP – CROSS**



**C. BILLET FUEL CAP – SIX SHOOTER**

## D. DIAMOND ICE TRIM RING – FUEL CAP AND GAUGE

These Trim Rings add a fine line of rhinestones around the perimeter of the fuel cap and matching fuel gauge and a deluxe finishing touch to the fuel tank. Chrome-plated rings feature adhesive backing for easy press-in-place installation.

<b>61400037</b>	Fuel Gauge.	<b>\$39.95</b>
Fits '83-later models equipped with fuel cap gauge.		

<b>61400038</b>	Fuel Cap.	<b>\$39.95</b>
-----------------	-----------	----------------

Fits '83-later models (except VRSC™, '04-'10 XL1200L and XL1200C, XL1200V, '08-later XR, '14-later XL, all FXD and FXDX models, '05-'06 FXDC, all FXR with plastic fuel cap, FXS, FXSB, FXSBSE, FLSTNSE, FXST-Aus, Electra Glide®, Road Glide®, Tour Glide™, Trike and all fuel caps with gauges).



**D. DIAMOND ICE TRIM RING – FUEL CAP**



**D. DIAMOND ICE TRIM RING – FUEL GAUGE**

### Model Family Fitment:

V-ROD	SPORTSTER	DYNA
SOFTAIL	TOURING	

Notice: The prices appearing in this catalog are the manufacturer's suggested retail prices. Actual retail prices may vary.



# 688 AUDIO & GAUGES

## Fuel Caps & Gauges

### A. SKULL & CHAIN FUEL CAP TRIM – CHROME

Links to the dark side. This mirror chrome collection stands out in a crowd, with a contrasting 3-D chain that rims the surface and surrounds the distinctive raised Willie G Skull. Select from the traditional skull design or for a little added flash, choose the version with the bright jewel-encrusted jaw line.

Fits '83-later models (except VRSC™, XG, XL883N, XL1200V, '04-'10 XL1200L and XL1200C, '08-later XR, '14-later XL, all FXD and FXDX models, '05-'06 FXDC, all FXR with plastic fuel cap, FXS, FXSB, FXSBSE, FLSTNSE, FXST-Aus, Electra Glide®, Road Glide®, Tour Glide™, Trike and all fuel caps with gauges).

<b>61100008</b>	Jeweled Skull.	<b>\$39.95</b>
<b>61100034</b>	Skull.	<b>\$39.95</b>

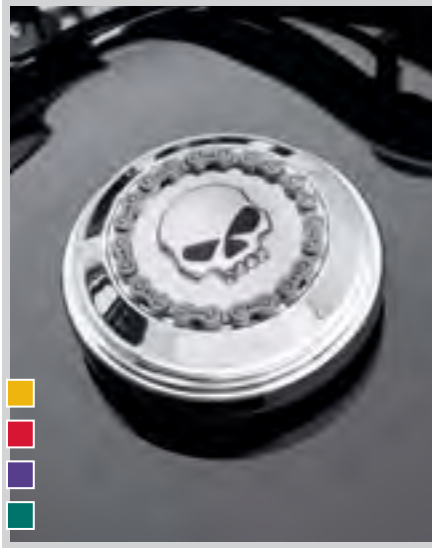

**A. SKULL & CHAIN FUEL CAP TRIM – CHROME JEWEL SKULL**

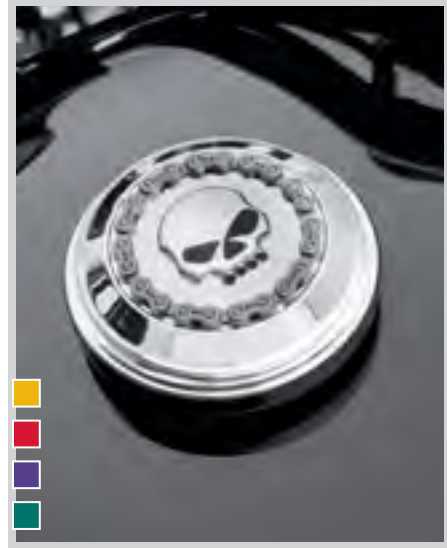

**A. SKULL & CHAIN FUEL CAP TRIM – CHROME SKULL**

### B. SKULL & CHAIN FUEL CAP TRIM – SMOKEY CHROME

The sinister smokey chrome finish is the ideal complement to a blacked-out ride and the contrasting 3-D chain rims the surface and surrounds the distinctive Willie G Skull with black-filled eyes. Select from the traditional skull design or for a little added zing, choose the version with the edgy jewel-encrusted jaw line. Either way, this complete collection is a tribute to the mechanical side of your ride.

Fits '83-later models (except VRSC, XG, XL883N, XL1200V, '04-'10 XL1200L and XL1200C, '08-later XR, '14-later XL, all FXD and FXDX models, '05-'06 FXDC, all FXR with plastic fuel cap, FXS, FXSB, FXSBSE, FLSTNSE, FXST-Aus, Electra Glide, Road Glide, Tour Glide, Trike and all fuel caps with gauges).

<b>61100018</b>	Jeweled Skull.	<b>\$39.95</b>
<b>61100032</b>	Skull.	<b>\$39.95</b>

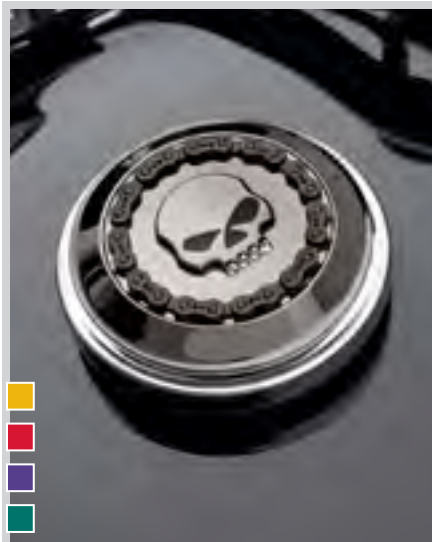

**B. SKULL & CHAIN FUEL CAP TRIM – SMOKEY CHROME JEWEL SKULL**

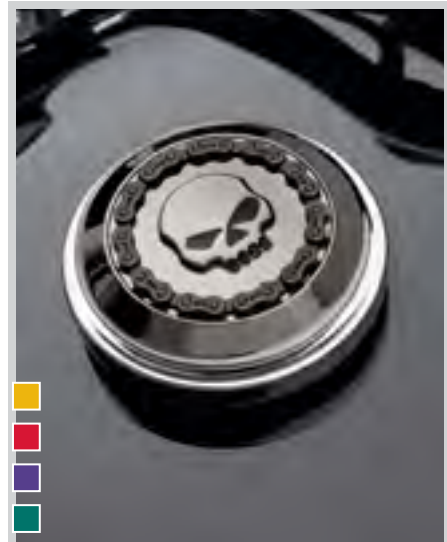

**B. SKULL & CHAIN FUEL CAP TRIM – SMOKEY CHROME SKULL**

### C. FUEL CAP MEDALLION – DIAMOND ICE

This self-adhesive Fuel Cap Medallion is easy to install and sets the rhinestone-laden Bar & Shield medallion "front and center" for maximum visibility. Medallion is contoured to fit many late-model fuel caps and also fits the surface of the Smooth LED Fuel Gauge P/N 75242-08A and 75237-03C.

<b>99690-10</b>	<b>\$41.95</b>
-----------------	----------------

Fits '83-later models (except VRSC, XG, XL883N, XL1200V, '04-'10 XL1200L and XL1200C, '08-later XR, '14-later XL, all FXD and FXDX models, '05-'06 FXDC, all FXR with plastic fuel cap, FXS, FXSB, FXSBSE, FLSTNSE, FXST-Aus, Electra Glide, Road Glide, Tour Glide, Trike and all fuel caps with gauges).

### D. FUEL CAP MEDALLION – WILLIE G SKULL

Top off your Original Equipment fuel cap. Adhesive backing for easy installation.

<b>99670-04</b>	<b>\$18.95</b>
-----------------	----------------

Fits '83-later models (except VRSC, XG, XL883N, XL1200V, '04-'10 XL1200L and XL1200C, '08-later XR, '14-later XL, all FXD and FXDX models, '05-'06 FXDC, all FXR with plastic fuel cap, FXS, FXSB, FXSBSE, FLSTNSE, FXST-Aus, Electra Glide, Road Glide, Tour Glide, Trike and all fuel caps with gauges).

<b>99669-04</b>	<b>\$18.95</b>
-----------------	----------------

Fits '04-'10 XL Custom and XL1200L models.

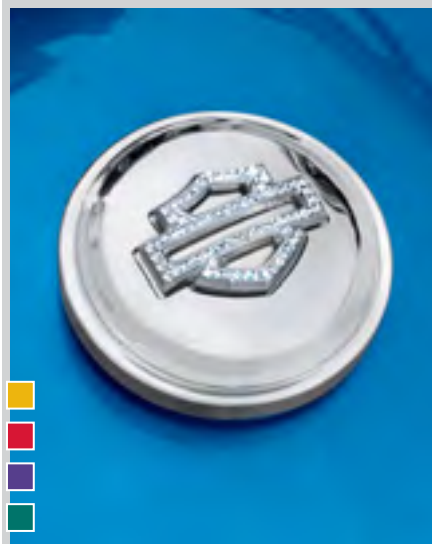

**C. FUEL CAP MEDALLION – DIAMOND ICE**



**D. FUEL CAP MEDALLION – WILLIE G SKULL**

#### Model Family Fitment:

V-ROD	SPORTSTER	DYNA
SOFTAIL	TOURING	

*Notice: The prices appearing in this catalog are the manufacturer's suggested retail prices. Actual retail prices may vary.*

# AUDIO & GAUGES 689

## Fuel Caps & Gauges



**E. FUEL CAP MEDALLION – NUMBER ONE SKULL – CHROME**



**E. FUEL CAP MEDALLION – NUMBER ONE SKULL – BLACK**



**F. FUEL CAP MEDALLION – CLOISSONNÉ – SILVER**



**F. FUEL CAP MEDALLION – CLOISSONNÉ – BLACK**



**G. FUEL CAP MEDALLION – “LIVE TO RIDE” – CHROME**



**G. FUEL CAP MEDALLION – “LIVE TO RIDE” – GOLD**



**H. FUEL CAP MEDALLION – FLAMES**



**I. FUEL CAP MEDALLION – H-D MOTOR CO. LOGO**

### E. FUEL CAP MEDALLION – NUMBER ONE SKULL

Decorative steel stamping with #1 Skull emblem. Contoured to the Original Equipment fuel cap. Adhesive backing for easy installation.

Fits '83-later models (except VRSC™, XG, XL883N, XL1200V, '04-'10 XL1200L and XL1200C, '08-later XR, '14-later XL, all FXD and FXDX models, '05-'06 FXDC, all FXR with plastic fuel cap, FXS, FXS, FXSB, FXSBSE, FLSTNSE, FXST-Aus, Electra Glide®, Road Glide®, Tour Glide™, Trike and all fuel caps with gauges).

<b>99673-10</b>	Chrome.	<b>\$19.95</b>
<b>99688-10</b>	Black.	<b>\$19.95</b>

### F. FUEL CAP MEDALLION – CLOISSONNÉ

Get decorated with this multi-colored cloisonné medallion featuring chrome-plated graphics. Adhesive backing for easy installation.

Fits '83-later models (except VRSC, XG, XL883N, XL1200V, '04-'10 XL1200L and XL1200C, '08-later XR, '14-later XL, all FXD and FXDX models, '05-'06 FXDC, all FXR with plastic fuel cap, FXS, FXS, FXSB, FXSBSE, FLSTNSE, FXST-Aus, Electra Glide, Road Glide, Tour Glide, Trike and all fuel caps with gauges).

<b>95741-01</b>	Silver.	<b>\$28.95</b>
<b>99537-96</b>	Black.	<b>\$28.95</b>

### G. FUEL CAP MEDALLION – “LIVE TO RIDE”

Top off your Original Equipment fuel cap. Adhesive backing for easy installation.

Fits '83-later models (except VRSC, XG, XL883N, XL1200V, '04-'10 XL1200L and XL1200C, '08-later XR, '14-later XL, all FXD and FXDX models, '05-'06 FXDC, all FXR with plastic fuel cap, FXS, FXS, FXSB, FXSBSE, FLSTNSE, FXST-Aus, Electra Glide, Road Glide, Tour Glide, Trike and all fuel caps with gauges).

<b>99020-86T</b>	Chrome.	<b>\$18.95</b>
<b>99020-90T</b>	Gold.	<b>\$26.95</b>

Fits '04-'10 XL Custom and XL1200L models.

<b>99667-04</b>	Gold.	<b>\$26.95</b>
-----------------	-------	----------------

### H. FUEL CAP MEDALLION – FLAMES

Top off your Original Equipment fuel cap. Adhesive backing for easy installation.

**99686-98** **\$26.95**

Fits '83-later models (except VRSC, XG, XL883N, XL1200V, '04-'10 XL1200L and XL1200C, '08-later XR, '14-later XL, all FXD and FXDX models, '05-'06 FXDC, all FXR with plastic fuel cap, FXS, FXS, FXSB, FXSBSE, FLSTNSE, FXST-Aus, Electra Glide, Road Glide, Tour Glide, Trike and all fuel caps with gauges).

<b>99668-04</b>		<b>\$26.95</b>
-----------------	--	----------------

Fits '04-'10 XL Custom and XL1200L models.

### I. FUEL CAP MEDALLION – H-D MOTOR CO.

Top off your Original Equipment fuel cap. Adhesive backing for easy installation.

**99539-97** **\$15.95**

Fits '83-later models (except VRSC, XG, XL883N, XL1200V, '04-'10 XL1200L and XL1200C, '08-later XR, '14-later XL, all FXD and FXDX models, '05-'06 FXDC, all FXR with plastic fuel cap, FXS, FXSB, FXSBSE, FLSTNSE, FXST-Aus, Electra Glide, Road Glide, Tour Glide, Trike and all fuel caps with gauges).

<b>99666-04</b>		<b>\$15.95</b>
-----------------	--	----------------

Fits '04-'10 XL Custom and XL1200L models.





GENUINE MOTOR PARTS & ACCESSORIES



2015

## LIGHTING

Where riding is concerned, brighter is always better, from euro-inspired LED projector beam headlamps to high-visibility brake lights. And when it comes to style, nothing brightens the boulevard like Genuine Motor Accessories auxiliary lighting.



## A BRIGHT IDEA

Whether you want to grab a little more attention on the boulevard or light up the dark desolate highway, Harley-Davidson® LED lighting will get you noticed.

Available for most models, LED headlamps feature high- and low-beam performance that provides a focused beam of light down the road and a pool in front of the motorcycle. Solid-state LEDs are designed for long life and the shock- and vibration-resistant lamp assemblies mount into existing housings for easy installation.



**Color Temperature Chart**

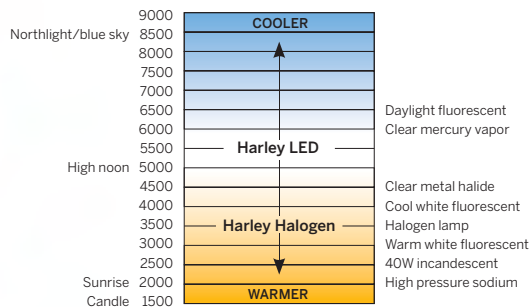

*LED Headlamp Color Temp – 5500*

*Dual Bulb Headlamp Color Temp – 3500*

*Original Equipment Headlamp Color Temp – 3500*



DARE TO COMPARE

Harley-Davidson® LED Headlamps offer low- and high-beam performance that is superior to traditional halogen bulbs. The wide curb-to-curb low-beam pattern provides a great around-town view and the projector high-beam adds extra punch down the center of the lane.

LED performance characteristics you can see:

- 1 Clarity and direction of beam
- 2 Brightness and depth of light
- 3 Focused or wasted light
- 4 Full coverage or gaps in light
- 5 Curb-to-curb coverage
- 6 Illumination of reflective markings

ORIGINAL EQUIPMENT HALOGEN 7" HEADLAMP – HIGH-BEAM\*

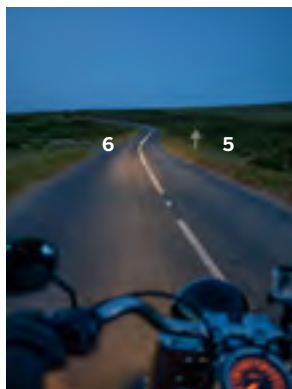

LIGHTING

LED 7" HEADLAMP – HIGH-BEAM\*

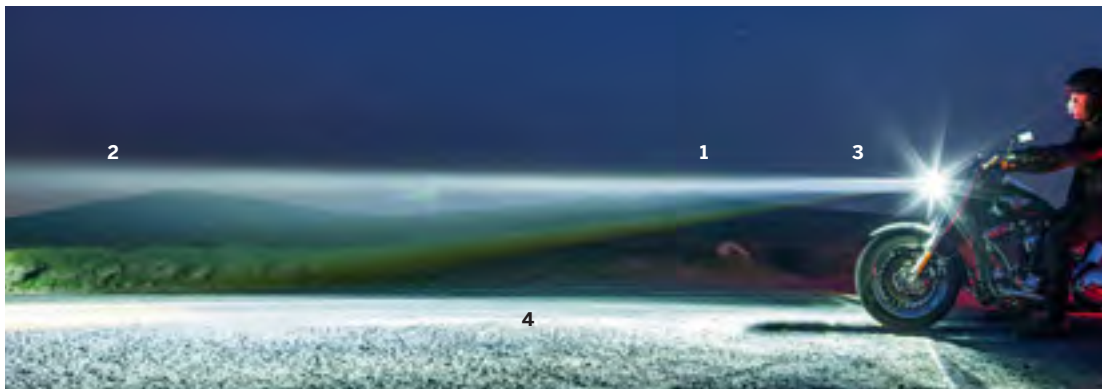
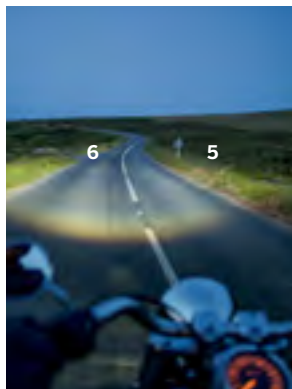

\*Image exposure settings are identical, taken from the same distance, at the same time and with identical motorcycles. While the eye and the camera see different things, the photographic results are comparable.

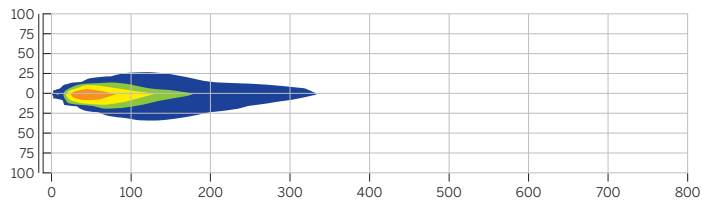

Original Equipment Halogen Low Beam (7") Birds Eye View (shown in feet)

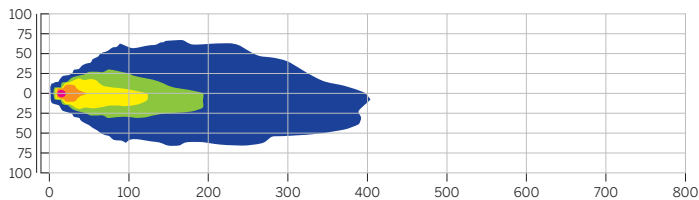

LED Headlamp Low Beam (7") Birds Eye View (shown in feet)

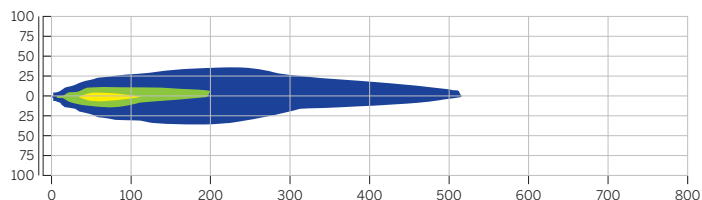

Original Equipment Halogen High Beam (7") Birds Eye View (shown in feet)

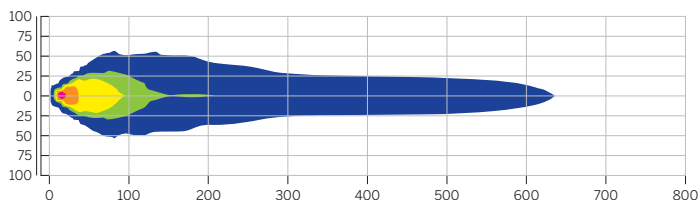

LED Headlamp High Beam (7") Birds Eye View (shown in feet)

# 694 LIGHTING

Headlamps – LED

## DAYMAKER™ LED LAMPS

Cut through the night. Harley-Davidson® LED Lamps are brighter and whiter in color and provide a superior light pattern over standard incandescent lamps. Compared to the yellow light of a traditional halogen bulb, the LED lamp produces a Daylight Color Impression that appears more natural to the user. Headlamps feature horizontal "D-shaped" lenses that focus light into a pool in front of the motorcycle and separate high beam and low beam projector lenses that provide a focused beam of light ahead. Lamps are available in your choice of brilliant chrome or gloss black background to match your styling direction. The solid-state LEDs are designed for long life and the shock- and vibration-resistant lamp assembly mounts into existing light housings. Installation is quick and easy and the plug-in lamps connect to the factory headlamp wiring.

### A. 7" DAYMAKER LED HEADLAMP

Headlamp features a single top-mount low-beam projector lens, a large bottom-mount high-beam projector lens and 2 "D" shaped fill-light lenses. The LED lamps are DOT approved for use in all 50 states.

Fits '12-later FLD, '94-'13 Touring (except Road Glide®) and '09-'13 Trike models. Also fits '94-later Softail® models equipped with Freight Train Headlamp Nacelle Kit. '06-'10 FLHTCUSE models require separate purchase of Wiring Harness P/N 71628-04.

<b>67700243</b>	7" Headlamp – Chrome.	<b>\$524.95</b>
<b>67700244</b>	7" Headlamp – Gloss Black.	<b>\$524.95</b>

Fits '91-later FLS, FLSTC, FLSTF, FLSTFB and FLSTN, '14-later Touring (except Road Glide) and '14-later Trike models. Does not fit Softail models equipped with Freight Train Headlamp Nacelle Kit. Touring and Trike models require separate purchase of Wiring Harness P/N 69200897.

<b>67700241</b>	7" Headlamp – Chrome.	<b>\$499.95</b>
<b>67700242</b>	7" Headlamp – Gloss Black.	<b>\$499.95</b>

### 4" DAYMAKER LED AUXILIARY LAMPS

Auxiliary lamps feature "D-shaped" lenses that focus the light in a pool to the front and sides of the motorcycle and provide a matching appearance to the LED headlamps.

Fits models with a 4" round auxiliary forward lighting. '04-earlier models with auxiliary lamps equipped with spade connectors require separate purchase of Adapter Harness P/N 68355-05 (Qty 2).

<b>68000172</b>	4" Auxiliary Lamps – Chrome.	<b>\$399.95</b>
<b>68000173</b>	4" Auxiliary Lamps – Gloss Black.	<b>\$399.95</b>

Also available:

### LED HEADLAMP KIT WIRING HARNESS

Required for installation of LED headlamp on specific models.

<b>69200897</b>	<b>\$19.95</b>
-----------------	----------------

Fits '14-later Touring (except Road Glide) and Trike models.



A. 7" DAYMAKER LED HEADLAMP – CHROME



A. 7" DAYMAKER LED HEADLAMP – GLOSS BLACK



A. 7" DAYMAKER LED HEADLAMP – CHROME

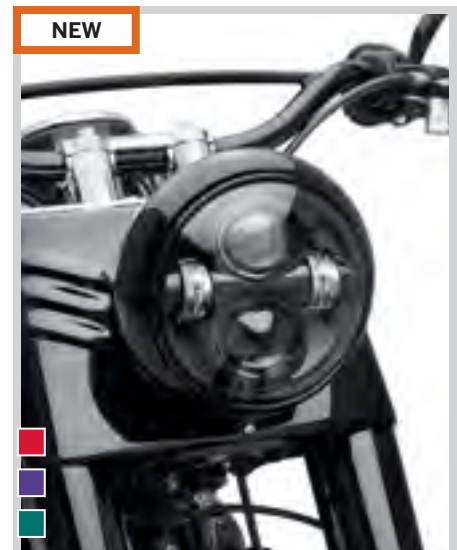

A. 7" DAYMAKER LED HEADLAMP – GLOSS BLACK

Notice: The prices appearing in this catalog are the manufacturer's suggested retail prices. Actual retail prices may vary.



# LIGHTING 695

Headlamps – LED



**B. 5-3/4" DAYMAKER LED HEADLAMP – CHROME**



**B. 5-3/4" DAYMAKER LED HEADLAMP – BLACK**

## B. 5-3/4" DAYMAKER™ LED HEADLAMP

Lamps feature 2 "D" shaped optical lenses, single low-beam lens and three high-beam lenses. The low-beam pattern remains on at all times and the switched high beam adds additional punch down the middle of the road. The LED lamps are DOT and ECE approved.

Fits '06-'11 VRSCD and VRSCDX, '15-later XG, '04-later XL, '09-'13 XR, '91-later Dyna® (except FLD and '05-earlier FXDWG), '84-'99 FXSTS and FLSTS, '00-later FXCW, FXCWC, FXS, FXSB, FXSBSE, FXST, FXSTB, FXSTC and FXSTD, '08-'11 FLSTS, '05-'06 FLSTSC and '10-'12 FLSTSE models. Some models require Vibration Damper P/N 67700059 or Housing Kit P/N 67700093.

<b>67700144</b>	5-3/4" Headlamp – Chrome.	<b>\$399.95</b>
<b>67700145</b>	5-3/4" Headlamp – Black.	<b>\$399.95</b>

**Also available:**

### HEADLAMP VIBRATION DAMPER

Required for mounting the LED headlight in certain models. This damper adds rigidity to the headlamp housing.

**67700059** \$7.95

Required on '13-later FXSB, '07-'10 FXSTC, '00-'07 FXSTD, '00-'06 FXSTS, '05-'07 FLSTSC and '00-'03 FLSTS models equipped with LED Headlamp.

**Also available:**

### 5-3/4" LED HEADLAMP HOUSING KIT

Required for installation of 5-3/4" LED Headlamp on specified models.

**67700093B** \$59.95

Required on '10-later XL1200X and '06-later Dyna models (except FXDWG) equipped with 5-3/4" LED headlamps. FXDF models require separate purchase of Mounting Block P/N 67741-06.

## C. ROAD GLIDE® DAYMAKER LED HEADLAMP

Road Glide® lamps feature dual headlamp housings mounted to a common back plate for easy installation. Each lamp features a single low-beam projector lens, 3 high-beam projector lenses and 2 "D" shaped fill-light lenses. The low-beam pattern remains illuminated at all times and the switched high-beam adds additional light down the center of the lane. The LED lamps are DOT and ECE approved.

Fits '04-'13 FLTR models.

<b>67700109</b>	Chrome.	<b>\$749.95</b>
<b>67700112</b>	Contrast Chrome & Black.	<b>\$749.95</b>



**C. ROAD GLIDE DAYMAKER LED HEADLAMP – CHROME**



**C. ROAD GLIDE DAYMAKER LED HEADLAMP – CONTRAST CHROME & BLACK**

**Model Family Fitment:**

- V-ROD
- SPORTSTER
- DYNA
- SOFTAIL
- TOURING

*Notice: The prices appearing in this catalog are the manufacturer's suggested retail prices. Actual retail prices may vary.*

# 696 LIGHTING

Headlamps – LED

## A. DAYMAKER™ REFLECTOR LED HEADLAMP

Daymaker™ Reflector LED Lamps offer superior night-time performance in a traditionally styled headlamp. These brilliant LED lamps produce a bright-white beam that lights up the surroundings and draws the attention of surrounding traffic. The natural "daylight" lamp color is easy on your eyes and is "tuned" to enhance and amplify the reflective character of highway signs and lane markers. The long-life solid-state LED lamps are housed in sealed shock and vibration-resistant lamp assemblies that mount into the existing light housing. Installation is simple and the plug-in lamps require no external ballast or complicated rewiring. Lamps are DOT and ECE approved.

## 7" DAYMAKER REFLECTOR LED HEADLAMP

Headlamps feature a powerful low-beam that illuminates the top half of the lamp to produce a wide pool of general lighting and a high-beam that adds focused light from the lower section to add punch down the middle of the lane. The low-beam remains illuminated at all times.

**67700173** 7" Headlamp. **\$424.95**  
Fits '12-later FLD, '94-'13 Touring (except Road Glide®) and '09-'13 Trike models. Also fits '94-later Softail® models equipped with Freight Train Headlamp Nacelle Kit. '06-'10 FLHTCUSE models require separate purchase of Wiring Harness P/N 71628-04.

**67700189** 7" Headlamp. **\$399.95**  
Fits '91-later FLS, FLSTC, FLSTF, FLSTFB and FLSTN. '14-later Touring (except Road Glide) and Trike models. Does not fit Softail models equipped with Freight Train Headlamp Nacelle Kit. Touring and Trike models require separate purchase of Wiring Harness P/N 69200897.

## 4" DAYMAKER REFLECTOR LED AUXILIARY LAMPS

Auxiliary lamps feature reflector bowls that are shaped to add an enhanced pool of light in front and to the sides of the motorcycle. The smooth lens and center-bar reflector design complements the matching headlamp for a unified look.

**68000075** 4" Auxiliary Lamp Kit. **\$359.95**  
Fits models with 4" round auxiliary forward lighting.

Also available:

## LED HEADLAMP KIT WIRING HARNESS

Required for installation of LED headlamp on specific models.

**69200897** **\$19.95**  
Fits '14-later Touring (except Road Glide) and Trike models.



A. DAYMAKER REFLECTOR LED HEADLAMP & AUXILIARY LAMPS



A. DAYMAKER REFLECTOR LED HEADLAMP & AUXILIARY LAMPS



A. DAYMAKER REFLECTOR LED HEADLAMP – FAT BOY WITH NACELLE



A. DAYMAKER REFLECTOR LED HEADLAMP & AUXILIARY LAMPS

Notice: The prices appearing in this catalog are the manufacturer's suggested retail prices. Actual retail prices may vary.





Dual Bulb Halogen Headlamp High Beam (7") Birds Eye View (shown in feet)

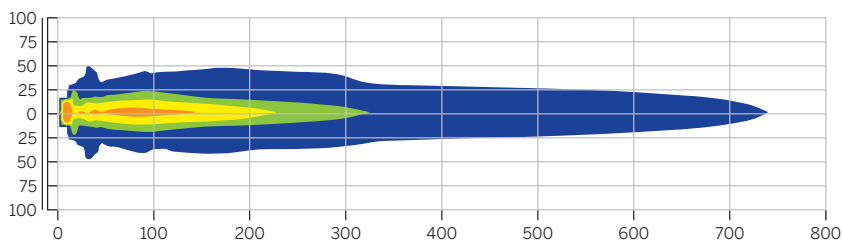

**B. DUAL BULB HALOGEN HEADLAMP KIT**  
(SHOWN WITH AUXILIARY LAMP BULB KIT – CLEAR LENS AND VERTICAL REFLECTOR OPTICS)



Original Equipment Headlamp High Beam (7") Birds Eye View (shown in feet)

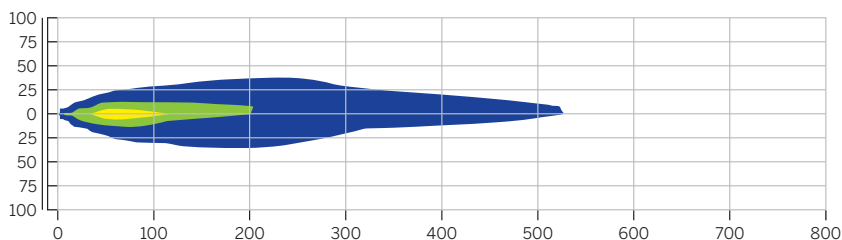

**C. HALOGEN HEADLAMP – CLEAR SMOOTH LENS WITH REFLECTOR OPTICS**  
(SHOWN WITH AUXILIARY LAMP BULB KIT – CLEAR LENS AND VERTICAL REFLECTOR OPTICS)

**B. DUAL BULB HALOGEN HEADLAMP KIT**

Featuring a higher wattage high beam and advanced reflector optics, this Dual Bulb Halogen Headlamp features separate bulbs for high and low beam functions. The euro-inspired projector beam styling combines a state-of-the-art look with a CAD-developed faceted reflector bowl that is optimized for crisp patterns and light cut-off. The single upper bulb functions in low beam and both upper and lower bulbs operate in high beam mode. The low beam setting produces a wide curb-to-curb light pattern and the high beam adds focused light down the center of the lane without compromising width. Kit includes die cast aluminum housing, 55-watt low beam halogen lamp, 65-watt high beam halogen lamp and all necessary mounting hardware. Does not meet ECE regulations.

**67700033** **\$144.95**  
Fits '91-later FLS, FLSTC, FLSTF, FLSTFB and FLSTN models. Does not fit models equipped with Freight Train Headlamp Nacelle Kit.

**67700032** **\$179.95**  
Fits '94-later FLD, '94-'13 Touring (except Road Glide®) and Trike models. Also fits '94-later FL Softail® models equipped with Freight Train Headlamp Nacelle Kit. Kit includes mounting ring assembly.

**C. HALOGEN HEADLAMPS – CLEAR SMOOTH LENS WITH REFLECTOR OPTICS**

Original Equipment on '05-later Harley-Davidson® models, these headlamps feature crystal clear lenses, mirror-finish reflector optics and replaceable halogen bulb.

Fits '15-later XG, '00-later XL, XR, Dyna® (except FXDF), FX Softail and '05 VRSCB models equipped with 5-3/4" headlamp. '00-'04 Dyna (except FXDWG) models require Adapter Ring P/N 67883-04.

**68297-05** 5-3/4" Domestic. **\$109.95**

Fits '15-later XG, '00-later XL, Dyna, FX Softail and '05 VRSCB HDI models equipped with 5-3/4" headlamp. All '00-'04 Dyna (except FXDWG), '04 XL883 and '04 1200R HDI models require Adapter Ring P/N 67883-04. '00-'04 XL883C and XL1200C HDI models require Adapter Ring P/N 67603-94. Some '00-'04 FXSTD/I, FXSTS/I and FLSTS/I models may also require Adapter Ring P/N 67603-94. See your Dealer for details.

**68335-05** 5-3/4" HDI Left Dip. **\$99.95**

**68341-05** 5-3/4" HDI Right Dip. **\$99.95**

Fits '00-later FL Softail and '00-'13 Touring models equipped with 7" headlamp. Some '00-'04 Touring models may require an updated Retaining Ring P/N 67726-71A for installation. See your Dealer for details.

**68342-05** 7" Domestic. **\$109.95**

Fits '00-later FL Softail and '00-'13 Touring HDI models equipped with 7" headlamp. Some '00-'04 HDI Touring models may require updated Retaining Ring P/N 67726-71A and Mounting Ring P/N 67732-71B for installation. See your Dealer for details.

**68344-05** 7" HDI Left Dip. **\$109.95**

**68345-05** 7" HDI Right Dip. **\$109.95**

Fits '00-'09 FLTR models.

**67775-01C** FLTR Domestic. **\$199.95**

**Model Family Fitment:**

- V-ROD
- SPORTSTER
- DYNA
- SOFTAIL
- TOURING

Notice: The prices appearing in this catalog are the manufacturer's suggested retail prices. Actual retail prices may vary.

# 698 LIGHTING

## Headlamp Shells

### A. BILLET HEADLAMP SHELL

Add style and substance to the front fork with this bullet-shaped Headlamp Shell. Manufactured from billet aluminum, this extended headlamp housing recesses the headlamp for a true custom appearance. The mirror-finish chrome surfaces and the close-fitting inner trim ring create the appearance of a one-piece design. Kit includes chrome-plated mounting hardware and a custom billet mount.

**67704-03** **\$339.95**

Fits '00-later FXS, FXSB, FXSBSE, FXST, FXSTB, FXSTC, FXSTD and '99-'05 FXDWG models. Also fits '02-'11 VRSC™ models (except VRSCF) equipped with Installation Bracket P/N 68211-05. Not Compatible with LED headlamps. (Does not fit International models.)

### B. BULLET HEADLAMP KIT

Light the way to a custom look. This mirror-chrome Bullet Headlamp Kit features a high-tech deep drawn aluminum housing that is precision machined for a perfect contour and surface finish. The visor-style shell adds a unique profile to the bike's front end and the complete kit includes a smooth lens lamp assembly with a replaceable halogen bulb.

Fits '14-later XL1200V, '96-'10 and '14-later XL1200C, '98-later XL883C, '94-later FXDWG, '06-later FXD, FXDC, FXDB, FXD35, FXDSE, FXDF, '06-'13 FXDL, '99-'00 FXR2/3/4, '84-'99 FXSTC, '99-later FXST, FXSTB, FXSTC, '08-later FXCW, FXCWC, FXS, FXSB, FXSBSE and '00-'07 FXSTD models. Installation requires separate purchase of appropriate Headlamp Mounting System P/N 68595-06 or 69611-06. Not compatible with LED headlamps.

**68593-06** 5-3/4" **\$349.95**

**69851-06** 4-1/2" **\$319.95**

#### Shown with:

#### HEADLAMP MOUNTING SYSTEM FOR BULLET HEADLAMP

Chrome-plated headlamp mounts are designed to position the Bullet Headlamp Kit in the proper location for specific vehicle applications. The mount is machined from solid steel for performance and durability and is polished and plated for a superior custom look.

**68595-06** Short Mount. **\$44.95**

Fits '94-'05 FXDWG, '84-'99 FXSTC, '99-later FXST, FXSTB and FXSTC, '08-later FXCW, FXCWC, FXS, FXSB, FXSBSE and '00-'07 FXSTD models.

**69611-06** Tall Mount. **\$49.95**

Fits '14-later XL1200V, '96-'10 and '14-later XL1200C, '98-later XL883C, '06-later FXD, FXDL, FXDC, FXDB, FXD35, FXDWG, FXDSE, FXDF and '99-'00 FXR2/3/4 models. Also fits '00-later FX Softail models equipped with Custom Inverted Front Fork Kit.

### C. DUAL HEADLAMP KIT

First introduced on the Fat Bob® model, this unique Dual Headlamp housing adds a slimmed-down custom look to the Wide Glide® model's stretched front end. Complete kit includes headlamp housing, headlamp bulbs and mounting hardware.

**69797-08** Domestic. **\$359.95**

Fits '06-later FXDWG models.

**69802-08** International. **\$359.95**

Fits '06-'08 FXDWG models.



A. BILLET HEADLAMP SHELL

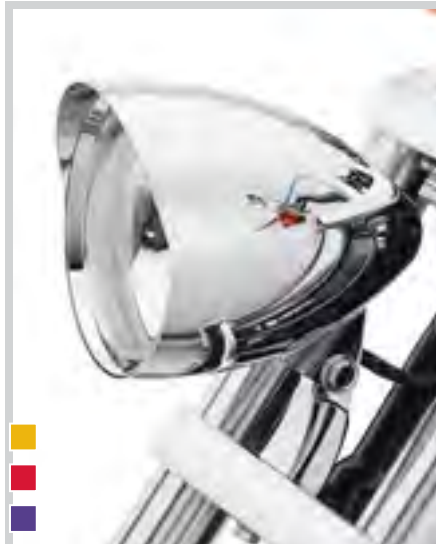

B. BULLET HEADLAMP AND MOUNTING KIT – 5-3/4"



B. BULLET HEADLAMP AND MOUNTING KIT – 4-1/2"



C. DUAL HEADLAMP KIT

Notice: The prices appearing in this catalog are the manufacturer's suggested retail prices. Actual retail prices may vary.



# LIGHTING 699

Headlamp Accessories



D. HEADLAMP MODULATION KIT (DYNA WIDE GLIDE SHOWN)

## D. HEADLAMP MODULATION KIT

It's time to get noticed in traffic. This Headlamp Modulation Kit flashes your headlamp low beam from full to low intensity, 4 times per second to improve conspicuity on the road. The Headlamp Modulation Kit includes an override switch to allow the rider to activate modulation when desired and features a light sensor so modulation will only occur during daytime use.

**67700139** **\$109.95**

Fits '12 Dyna® FLD, '87-'13 FLHT, FLHX and FLHR and '98-'13 FLTR models (NOTE: On FLTR, only one headlamp will modulate). Not for use with HID or LED Headlamps.

**67700078** **\$109.95**

Fits '05-later VRSC™ and '04-later XL, Dyna (except FLD and FXDF) and Softail® models. Installation on FLSTC and FLSTN models require separate purchase of Independent Control Auxiliary Lamp Wire Harness P/N 69200442. Not for use with HID or LED headlamps.



## E. INDEPENDENT CONTROL AUXILIARY LAMP WIRE HARNESS KIT

Maximize your nighttime view down a lonely stretch of back road. This simple-to-install wiring harness permits independent control of your bike's auxiliary lamps and allows the lamps to be switched on when the headlamp is in either the low or high beam setting.

**69200441** **\$29.95**

Fits '98-'13 Electra Glide®, Street Glide® and Trike models equipped with auxiliary lamps.

**69200442** **\$29.95**

Fits '96-later FL Softail and '97-'13 Road King® models equipped with auxiliary lamps.



D. HEADLAMP MODULATION KIT – HANDLEBAR SWITCH



D. HEADLAMP MODULATION KIT



E. INDEPENDENT CONTROL AUXILIARY LAMP WIRE HARNESS KIT (TOURING SHOWN)

### Model Family Fitment:

- V-ROD
- SPORTSTER
- DYNA
- SOFTAIL
- TOURING

*Notice: The prices appearing in this catalog are the manufacturer's suggested retail prices. Actual retail prices may vary.*

# 700 LIGHTING

Headlamps – Auxiliary

## A. AUXILIARY LIGHTING KIT

There's a lot of road on this planet and these chrome lamps will light the way. Just add the desired lamp bulb kit (sold separately) to complete the installation. The kit includes the chrome lamp housings and the chrome mounting brackets that match the contour of the triple tree and highlight the headlamp. Kit comes complete with the necessary wiring, switch and hardware for installation. Can be used with Turn Signal Relocation Kit P/N 68603-01 (Bulbs sold separately.)

**69284-05** **\$299.95**

Fits '88-'13 XL and '91-'05 Dyna® models (except FXDWG, FXDS-CONV. and FXDXT). Also fits '88-'94 FXR, FXRS and FXLR models. '88-'97 XL883, '88-'96 XL883 Deluxe, '96-'97 XL1200S, '88-'94 FXRS-SP and '91-'92 FXDB-S require Turn Signal Relocation Kit P/N 68603-01. Will not fit FXR models equipped with engine guards or Front Directional Signal Relocation Kit P/N 68517-94A.

**68000110** **\$299.95**

Fits '14-later XL models (except XL1200T).

**69285-05A** **\$299.95**

Fits '93-'05 FXDWG and '84-later FXS, FXST, FXSTC and FXSTB models.

**68605-08A** **\$289.95**

Fits '06-later Dyna (except FLD) and '13-later FXSB models.

**Also available:**

### TURN SIGNAL RELOCATION KIT

This kit relocates the turn signals to the passing lamp bracket and allows the use of a detachable windshield. Kit includes all necessary hardware required for installation.

**68603-01** **\$49.95**

Fits '88-later XL (except XL1200T), '91-'05 Dyna and '84-later FXS, FXST, FXSTC and FXSTB models equipped with Auxiliary Lighting Kits.

**Also available:**

### WINDSHIELD DOCKING HARDWARE AND TURN SIGNAL RELOCATION KIT

Required for installation of H-D® Detachables™ Windshields on FXDWG and FXST models equipped with Passing Lamps. Includes windshield mounting hardware and turn signal relocation hardware.

**58361-03** **\$89.95**

Fits '93-'05 FXDWG and '84-later FXST, FXSTC and FXSTB models equipped with Auxiliary Lighting Kits.



**A. AUXILIARY LIGHTING KIT – '06-LATER DYNA MODELS  
(SHOWN WITH AUXILIARY LAMP BULB KIT)**



**A. AUXILIARY LIGHTING KIT – FX SOFTAIL/DYNA WIDE GLIDE  
(SHOWN WITH AUXILIARY LAMP BULB KIT AND TURN SIGNAL RELOCATION KIT)**

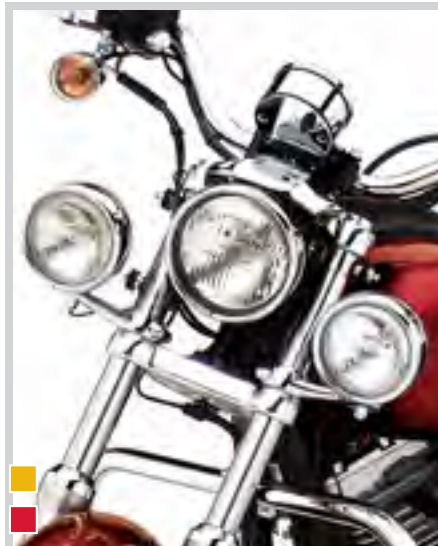

**A. AUXILIARY LIGHTING KIT –  
SPORTSTER/DYNA  
(SHOWN WITH AUXILIARY LAMP BULB KIT)**

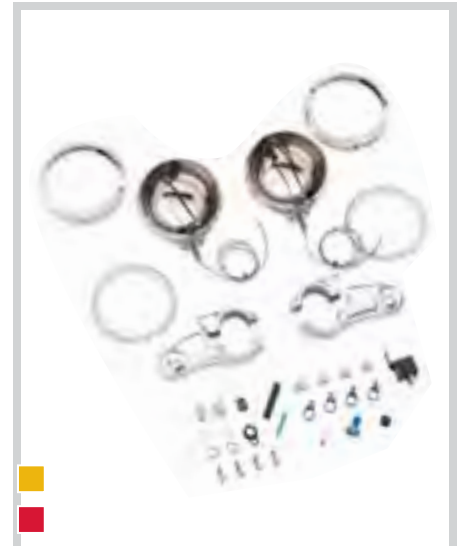

**A. AUXILIARY LIGHTING KIT  
(69284-05 SHOWN)**

*Notice: The prices appearing in this catalog are the manufacturer's suggested retail prices. Actual retail prices may vary.*





**B. CUSTOM AUXILIARY LIGHTING KIT  
(SHOWN WITH AUXILIARY LAMP BULB KIT)**

### B. CUSTOM AUXILIARY LIGHTING KIT

Shaped by the wind, this Auxiliary Lighting Kit follows the contours of the triple tree and headlamp shell for a custom look. The chrome-plated cantilever brackets serve as stylized mounting points for the passing lamp housings and eliminate the cross brace and flat side supports of traditional auxiliary lamps. The brackets can also accommodate the bike's Original Equipment bullet turn signals if you choose to relocate them from the handlebar for a clean look. Kit includes die-cast aluminum brackets, lamp housings and all required wiring and hardware. All you need to add is your choice of bulb style and you'll light up the open road. Bulbs sold separately.

**68000051** **\$309.95**  
Fits '12-later Dyna® FLD and '00-later FLS, FLSTF and FLSTFB models. FLS, FLSTF and FLSTFB models require the separate purchase of Mounting Kit P/N 68000069.

**Also available:**

### CUSTOM AUXILIARY LIGHTING MOUNTING KIT – FAT BOY®

Required for installation of Custom Auxiliary Lighting Kit P/N 68000051 on Fat Boy® and Slim® models. Kit includes fasteners, wiring and windshield mounting hardware.

**68000069** **\$59.95**  
Required for installation of Custom Auxiliary Lighting Kit P/N 68000051 on Fat Boy and Slim models.

### C. AUXILIARY LIGHTING KIT – FL SOFTAIL® MODELS

Function and style in one. This Auxiliary Lighting Kit features attractive mounting brackets and a tubular crossbar contoured to accent the headlamp. Available in bright chrome or gloss black finish, the kit includes lamp housings and all required wiring, toggle switch and hardware. All you need to add is your choice of bulb style and you'll light up the open road. (Bulbs sold separately.)

Fits '00-later FLS, FLSTF, FLSTFB and '06 FLST models.

<b>69287-07</b>	Chrome.	<b>\$239.95</b>
<b>68000026</b>	Gloss Black.	<b>\$199.95</b>

**Shown with:**

### TURN SIGNAL RELOCATION KIT FOR AUXILIARY LIGHTING KITS

Easy to install, this kit relocates the turn signals from the handlebar to the auxiliary lamp chrome mounting bracket. Provides a clean look to the front end of the motorcycle by removing wires and lights from the handlebar area. Kit includes turn signals for auxiliary lamps, mounting bracket and all necessary hardware.

Fits Softail® models equipped with Auxiliary Lighting Kit P/N 69287-07.

<b>68413-99A</b>	Domestic.	<b>\$109.95</b>
<b>68412-99A</b>	International.	<b>\$109.95</b>



**C. AUXILIARY LIGHTING KIT – FL SOFTAIL MODELS, CHROME  
(SHOWN WITH AUXILIARY LAMP BULB KIT AND TURN SIGNAL RELOCATION KIT)**



**C. AUXILIARY LIGHTING KIT – FL SOFTAIL MODELS, GLOSS BLACK  
(SHOWN WITH AUXILIARY LAMP BULB KIT)**

**Model Family Fitment:**

<span style="display: inline-block; width: 10px; height: 10px; background-color: #ccc; border: 1px solid #000;"></span> V-ROD	<span style="display: inline-block; width: 10px; height: 10px; background-color: #ffc000; border: 1px solid #000;"></span> SPORTSTER	<span style="display: inline-block; width: 10px; height: 10px; background-color: #ff0000; border: 1px solid #000;"></span> DYNA
<span style="display: inline-block; width: 10px; height: 10px; background-color: #4b0082; border: 1px solid #000;"></span> SOFTAIL	<span style="display: inline-block; width: 10px; height: 10px; background-color: #008000; border: 1px solid #000;"></span> TOURING	

*Notice: The prices appearing in this catalog are the manufacturer's suggested retail prices. Actual retail prices may vary.*

## 702 LIGHTING

Headlamps – Auxiliary

### A. DELUXE AUXILIARY LIGHTING KIT – FL SOFTAIL® MODELS

Shaped by the wind. These billet-look mounting brackets hug the contour of the smooth chrome Triple Tree Cover (included). Separate purchase of the sealed lamp is required to allow the flexibility to choose from four different styles. Bulbs sold separately.

Fits '00-later FLS, FLSTF and '06 FLST models. Compatible with Nostalgic Windshield Kit P/N 57140-05, 57181-05 and 57141-05 only. Will not fit with Chrome Headlamp Nacelle Kit P/N 67907-96B.

<b>68669-05A</b>	Domestic.	<b>\$399.95</b>
<b>68670-05A</b>	International.	<b>\$399.95</b>

### B. AUXILIARY LIGHTING KIT – SPRINGER™ MODELS

Chrome mounting bracket nicely accents Springer™ front end and offers an integrated factory-installed appearance. Just add the desired lamp kit (sold separately) to complete the installation. The kit includes the chrome lamp housings, chrome mounting brackets and all necessary wiring, switch and hardware for installation. Designed to fit with or without windshields and Horn Kit P/N 69036-88A. Cannot be used with Handlebar Reservoir Cover Set P/N 46098-98 or 46099-98. Bulbs sold separately.

<b>69286-05B</b>	<b>\$299.95</b>
Fits '88-later FXSTS, FXSTSB and '05-later FLSTSB and FLSTSC models.	

### C. AUXILIARY LIGHTING KIT – ROAD KING® CUSTOM

Add traditional style and function to the Road King® Custom with an Auxiliary Lighting Kit. Kit includes chrome lamp housings, tubular chrome mounting bracket, chrome triple tree mounting plates, windshield docking hardware and all required wiring and installation hardware. All you need to add is your choice of bulb style. Bulbs sold separately.

<b>69289-05</b>	<b>\$239.95</b>
Fits '04-'07 FLHRS models. Will fit with windshields.	



A. DELUXE AUXILIARY LIGHTING KIT – FL SOFTAIL MODELS  
(SHOWN WITH AUXILIARY LAMP BULB KIT)



B. AUXILIARY LIGHTING KIT – SPRINGER MODELS  
(SHOWN WITH AUXILIARY LAMP BULB KIT)



C. AUXILIARY LIGHTING KIT – ROAD KING CUSTOM  
(SHOWN WITH AUXILIARY LAMP BULB KIT)

*Notice: The prices appearing in this catalog are the manufacturer's suggested retail prices. Actual retail prices may vary.*



# LIGHTING 703

Headlamps – Auxiliary



**D. CUSTOM AUXILIARY LIGHTING KIT – CHROME**  
(SHOWN WITH LAMP BRACKET TURN SIGNAL KIT AND HARDWARE KIT)



**D. CUSTOM AUXILIARY LIGHTING KIT – CHROME**



**D. '97-'13 MODELS**

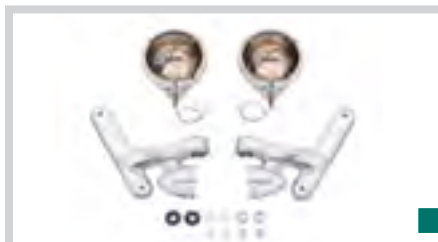

**D. '14-LATER MODELS**



**D. '97-'13 MODELS**



**D. '14-LATER MODELS**



**D. CUSTOM AUXILIARY LIGHTING KIT – GLOSS BLACK**

## D. CUSTOM AUXILIARY LIGHTING KIT

Shaped by the wind, this Auxiliary Lighting Kit follows the contours of the triple tree and headlamp shell for a custom look. The elegant cantilever brackets serve as stylized mounting points for the passing lamp and turn signal housings and eliminate the cross brace and flat side supports of traditional auxiliary lamps.

Fits '14-later FLHX and FLHXS models. Kit includes passing lamp housings, retaining rings, mounting brackets, bullet turn signals, auxiliary lamp switch and hardware. Auxiliary Lamp Bulbs sold separately.

<b>67800367</b>	Chrome.	<b>\$429.95</b>
<b>67800366</b>	Gloss Black.	<b>\$429.95</b>

Fits '06-'13 FLHX and FLHXXX models. Kit includes passing lamp housings, retaining rings, mounting brackets, auxiliary lamp switch and hardware. Auxiliary Lamp Bulbs and Bullet Turn Signal Kits sold separately.

<b>69818-06</b>	Chrome.	<b>\$349.95</b>
<b>68000042</b>	Gloss Black.	<b>\$369.95</b>

Fits '97-'13 Electra Glide® models (except FLHX) and '94-'13 Road King® models. Road King models equipped with windshield require separate purchase of Hardware Kit P/N 69235-04. For installation on FLHRS models that do not presently have a windshield, but wish to install a windshield, the additional purchase of Hardware Kit P/N 69234-04 is required. Kit includes passing lamp housings, mounting brackets and hardware. Installation reuses Original Equipment sealed beam lamps and retaining rings. Bullet Turn Signal Kits sold separately.

<b>69227-04A</b>	Chrome.	<b>\$329.95</b>
<b>68000043</b>	Gloss Black.	<b>\$349.95</b>

### Shown with: CUSTOM AUXILIARY LAMP BRACKET TURN SIGNAL KIT

Add your choice of Bullet Style Turn Signals to the Custom Passing Lamp Bracket. Select from amber, clear or smoked lens turn signal kits to complement your custom direction. Kit includes left and right bullet turn signal housing, two lenses and two front bulbs.

Fits '94-'13 FLHR and '97-'13 FLHT and FLHX models equipped with Custom Auxiliary Lighting Bracket Kits.

<b>69230-04</b>	Chrome Amber Lens, Clear Bulb.	<b>\$69.95</b>
<b>69229-04</b>	Chrome Clear Lens, Amber Bulb.	<b>\$69.95</b>
<b>69228-04</b>	Chrome Smoked Lens, Amber Bulb.	<b>\$69.95</b>
<b>67800166</b>	Black Smoked Lens, Amber Bulb.	<b>\$69.95</b>

### Shown with: CUSTOM AUXILIARY LAMP BRACKET HARDWARE KIT

Add Custom Passing Lamp Brackets to your Road King model. **69235-04** Required to install the Custom Auxiliary Lighting Bracket Kit P/N 69227-04A on '94-'13 Road King models equipped with a H-D® Detachables™.

**69234-04** Required to install the Custom Auxiliary Lighting Bracket Kit P/N 69227-04A on FLHRS models not presently equipped with a windshield, but wish to install a windshield at the same time or in the future. **\$16.95**

### Model Family Fitment:

- V-ROD
- SPORTSTER
- DYNA
- SOFTAIL
- TOURING

*Notice: The prices appearing in this catalog are the manufacturer's suggested retail prices. Actual retail prices may vary.*

# 704 LIGHTING

Headlamps – Auxiliary

## A. DAYMAKER™ REFLECTOR LED FOG LAMPS

Compact 2.5" bullet-shaped reflector-optics fog lamps produce a bright white pool of light near the vehicle and fill in the dark area between the bike and the low-beam pattern. The fog lamps project a smooth light pattern spread without distracting "hot spots" and the natural "daylight" lamp color enhances and amplifies the reflective character of lane markers. Unlike some traditional fog lamps, the low-draw LED lamps do not burden the bike's electrical system. The long-life solid-state LED lamps are sealed in shock and vibration-resistant housings that mount to the engine guard for a clean appearance.

Fits Dyna®, Softail®, Touring and Trike models equipped with 1.25" diameter Engine Guards. Does not fit models with Mustache Engine Guards. Installation requires separate purchase of model-specific Clamp Kit and Wiring Harness Kit.

<b>68000090</b>	Chrome Housing.	<b>\$399.95</b>
<b>68000092</b>	Gloss Black Housing.	<b>\$399.95</b>

Also available:

### LED FOG LAMP WIRING HARNESS

Required for installation of LED Fog Lamp P/N 68000090 or 68000092 on specific models.

<b>69200863</b>	<b>\$24.95</b>
Fits Dyna and Softail models. Kit includes universal handlebar-mounted switch.	

<b>69201108</b>	<b>\$24.95</b>
Fits '97-later Road King® (except FLHRS) and '15-later Freewheeler™ models. Kit uses Original Equipment nacelle switch to power the fog lamps.	

<b>69201109</b>	<b>\$24.95</b>
Fits '14-later Electra Glide®, Road Glide®, Street Glide® and Tri Glide® models. Street Glide and Road Glide Custom models require separate purchase of Switch Pack P/N 69200172.	

<b>69200864</b>	<b>\$24.95</b>
Fits '97-'13 Electra Glide, Road Glide, Street Glide and Trike models. Models without an Original Equipment fog lamp switch require separate purchase of Switch Kit P/N 71505-96.	

## B. LED FOG LAMP ENGINE GUARD CLAMP KIT

Required for installation of LED Fog Lamp P/N 68000090 or 68000092 on specific models. Kit includes left and right clamp and all required mounting hardware. Lamps and wiring harnesses sold separately.

Fits Touring and Trike models equipped with 1.25" Engine Guards and fairing lowers.

<b>68000170</b>	Chrome.	<b>\$49.95</b>
<b>68000142</b>	Gloss Black.	<b>\$49.95</b>

Fits Dyna, Softail, Touring, and Trike models equipped with 1.25" engine guards. Does not fit models with Mustache Engine Guards. Does not fit models equipped with Original Equipment or accessory fairing lowers.

<b>68000171</b>	Chrome.	<b>\$49.95</b>
<b>68000141</b>	Gloss Black.	<b>\$49.95</b>



**A. DAYMAKER REFLECTOR LED FOG LAMPS – CHROME**



**A. DAYMAKER REFLECTOR LED FOG LAMPS – CHROME**

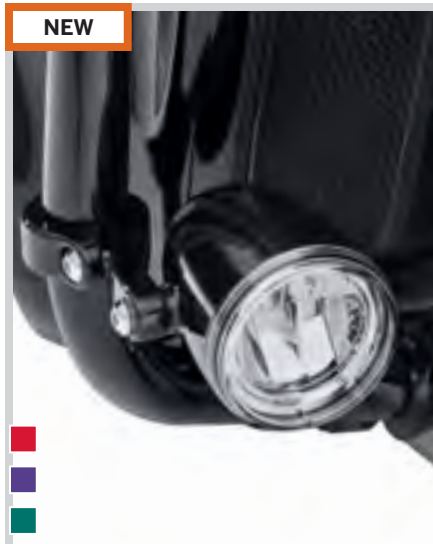

**A. DAYMAKER REFLECTOR LED FOG LAMPS – GLOSS BLACK**



**A. DAYMAKER REFLECTOR LED FOG LAMPS – GLOSS BLACK**



**A. DAYMAKER REFLECTOR LED FOG LAMPS – CHROME & GLOSS BLACK**

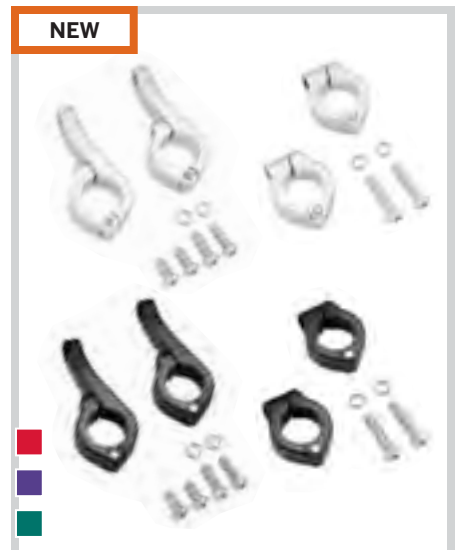

**B. LED FOG LAMP ENGINE GUARD CLAMP KITS – CHROME & GLOSS BLACK**

Notice: The prices appearing in this catalog are the manufacturer's suggested retail prices. Actual retail prices may vary.



# LIGHTING 705

Headlamps – Auxiliary



**C. ENGINE GUARD-MOUNTED FOG LAMPS**

## C. ENGINE GUARD-MOUNTED FOG LAMPS

Uniquely styled halogen fog lamps feature a 55-watt bulb and clear lens with a faceted inner reflector. The beautifully polished and chrome-plated housings are designed to bolt easily onto most Harley-Davidson® front engine guards. Kit comes complete with a pair of fog lamps, fused harness, relay and switch. May not conform to local lighting regulations. Check local laws.

**68000118** **\$174.95**

Fits '14-later Touring models equipped with 1.25" diameter Original Equipment-style engine guard. Will not fit Touring models equipped with Mustache Engine Guard or Color-Matched or Soft Fairing Lower.

**68913-98C** **\$169.95**

Fits most models equipped with 1.25" diameter Engine Guards. Will not fit '15-later XG, '14-later Touring and Trike, '98-later FLTR, '06-later VRSCR equipped with Engine Guard, '04-later XL and XR equipped with Engine Guard and '00-later Softail® models equipped with Nostalgic Engine Guard or Mustache Engine Guard. Will not fit Touring models equipped with Fairing Lower, Splash Shields or Mustache Engine Guard or any model equipped with Handlebar Reservoir Cover Set P/N 46098-98 or 46099-98.



## D. PERFORMANCE HEADLAMP BULB

This Xenon gas-filled replacement headlamp bulb lights the way with a whiter, more natural light. The coating on the lamp shows a slight blue tint to the oncoming traffic.

**67074-02** **\$29.95**

Fits all models with replaceable headlamp bulb (except '02-later VRSCA, '04 VRSCB, '06-later VRSCR, VRSCX, VRSCF, '15-later XG, '08-'12 XR and models equipped with Dual Bulb Halogen Headlamp Kit P/N 67864-04 or 67863-04).

## E. AUXILIARY LAMP BULB KITS

Available in 3 lens styles, these sealed beam bulbs are a direct replacement for Original Equipment or accessory Auxiliary Lighting Kits.

Fits all models with Original Equipment or accessory Auxiliary Lighting Kits (except '14-later Touring models). Sold in pairs.

### 1. Smoked with Lens Optics

**68273-03A** **\$69.95**

### 2. Clear Lens with Halogen Bulb

**68208-98A** **\$69.95**

### 3. Clear Lens and Vertical Reflector Optics

**68348-05** **\$69.95**

## F. BAR & SHIELD LOGO AUXILIARY LAMP COVERS

Add a degree of protection and style to your auxiliary lighting with these slip-on Bar & Shield Lamp Covers. The vinyl covers hug the contours of the lamp and help deflect bugs and dirt from the lamp trim ring for easy cleaning. The elastic bands and hooks hold the covers firmly in place. Kit includes right and left cover.

**67593-05** **\$19.95**

Fits models with Original Equipment or accessory H-D® Auxiliary Lighting Kits (except '14-'15 FLSTNSE). Will not fit with Passing Lamp Visors.



**C. ENGINE GUARD-MOUNTED FOG LAMPS**



**D. PERFORMANCE HEADLAMP BULB**



**E. AUXILIARY LAMP BULB KITS**



**F. BAR & SHIELD LOGO AUXILIARY LAMP COVERS**

### Model Family Fitment:

- V-ROD
- SPORTSTER
- DYNA
- SOFTAIL
- TOURING

*Notice: The prices appearing in this catalog are the manufacturer's suggested retail prices. Actual retail prices may vary.*

LIGHTING

# 706 LIGHTING

## Turn Signals

### A. LED FLAT LENS TURN SIGNALS

Beautiful signature light for models with Flat Lens Turn Signals. These turn signals feature fast-acting, extra bright LEDs set in low-profile die-cast chrome housings. In the front, the lights function as running light and directional indicators. In the rear, the lights function as running light, brake light and directional indicators. The front amber lights are available in your choice of smoked or amber lens and the red rear lights are offered with either smoked or red lens. Installation does not require installation of a "control box" or load equalizer and the turn signals attach directly to existing wiring without cutting or splicing. Featuring pillow-style optics, a horizontal chrome band and a Bar & Shield medallion, these signals are the perfect match for the available LED Tail Lamps. Sold in pairs.

Fits '14-later Touring models equipped with flat lens turn signals.

<b>67800374</b>	Front, Amber Lens.	<b>\$179.95</b>
<b>67800375</b>	Front, Smoked Lens.	<b>\$179.95</b>

Fits '01-later FLSTC and '01-'13 Touring models equipped with flat lens turn signals.

<b>68411-10</b>	Front, Amber Lens.	<b>\$179.95</b>
<b>68435-10</b>	Front, Smoked Lens.	<b>\$179.95</b>

Fits '99-later FLSTC and '01-later Touring models equipped with flat lens turn signals.

<b>68127-10</b>	Rear, Smoked Lens.	<b>\$179.95</b>
<b>68128-10</b>	Rear, Red Lens.	<b>\$179.95</b>

### B. TURN SIGNAL LENS KIT – SMOKED AND CLEAR

Add a unique touch to your bike. These Turn Signal Lens Kits replace the amber lenses for a clean front and rear appearance. Available in clear and smoked versions. Meets DOT requirements.

Fits '86-later models with Flat Turn Signal Lenses. Kit includes 4 lenses and 4 amber bulbs.

<b>69307-02</b>	Clear – Flat Lens.	<b>\$39.95</b>
<b>69308-02</b>	Smoked – Flat Lens.	<b>\$39.95</b>



A. LED FLAT LENS TURN SIGNAL – AMBER



A. LED FLAT LENS TURN SIGNAL – SMOKED



A. LED FLAT LENS TURN SIGNAL – RED



B. TURN SIGNAL LENS KIT – FLAT LENS, CLEAR

B. TURN SIGNAL LENS KIT – FLAT LENS, SMOKED

Notice: The prices appearing in this catalog are the manufacturer's suggested retail prices. Actual retail prices may vary.





**C. LED BULLET TURN SIGNAL KIT – AMBER LENS**



**C. LED BULLET TURN SIGNAL KIT – SMOKED LENS**



**C. LED BULLET TURN SIGNAL KIT – RED LENS**



**D. TURN SIGNAL LENS KIT – CLEAR, BULLET LENS**



**D. TURN SIGNAL LENS KIT – SMOKED, BULLET LENS**

### C. LED BULLET TURN SIGNAL KIT

These Turn Signals feature fast-acting, extra bright LEDs set in compact bullet-shaped die-cast chrome housings. In the front, the lights function as running light and directional indicators. In the rear, the lights function as running light, brake light and directional indicators. The front amber lights are available in your choice of smoked or amber lens and the red rear lights are offered with either smoked or red lens. Installation does not require installation of a "control box" or load equalizer and the turn signals attach directly to existing wiring without cutting or splicing. Featuring a Bar & Shield medallion, these signals are the perfect match for the available LED Tail Lamps. Sold in pairs.

Fits '12-later Dyna®, '11-later FXS, FLS, FLSTF, FLSTFB and '08-'11 FLSTSB models. Does not fit FLSTSE2/3 models.

<b>67800061</b>	Front, Amber Lens.	<b>\$189.95</b>
<b>67800060</b>	Front, Smoked Lens.	<b>\$189.95</b>

Fits '12-later FXDC, '12-'13 FXDF, '11-later FLSTF, FLSTFB and '08-'11 FLSTSB models. Does not fit FLSTSE2/3 models. Not for use with Layback License Plate Kit P/N 60215-06.

<b>67800055</b>	Rear, Smoked Lens.	<b>\$189.95</b>
<b>67800056</b>	Rear, Red Lens.	<b>\$189.95</b>

### D. TURN SIGNAL LENS KIT – SMOKED AND CLEAR

Add a unique touch to your bike. These Turn Signal Lens Kits replace the amber lenses for a clean front and rear appearance. Available in clear and smoked versions. Meets DOT requirements.

Fits '00-later models with bullet turn signals (except VRSC™ and models equipped with rear red lens stop/turn/tail signals). Will also fit V-Rod® models equipped with Chrome Turn Signal Kit P/N 69374-05 or 69065-05. Kit includes 4 lenses and 4 amber bulbs.

<b>69303-02</b>	Clear – Bullet Lens.	<b>\$39.95</b>
<b>69304-02</b>	Smoked – Bullet Lens.	<b>\$39.95</b>

Fits '01-earlier models equipped with dome lens style turn signals. This kit includes 2 lenses and 2 amber bulbs.

<b>69306-02</b>	Smoked – Dome Lens. (not shown)	<b>\$39.95</b>
-----------------	---------------------------------	----------------

Fits front lenses on '08-later XL 883N, XL1200N, XL1200X, '11-later XL1200C, XL1200V, '08-later FXCW, FXCWC, FXS and FLS models. This kit includes 2 lenses and 2 amber bulbs.

<b>69208-09</b>	Smoked – Bullet Lens.	<b>\$24.95</b>
-----------------	-----------------------	----------------

#### Model Family Fitment:

V-ROD	SPORTSTER	DYNA
SOFTAIL	TOURING	

Notice: The prices appearing in this catalog are the manufacturer's suggested retail prices. Actual retail prices may vary.

# 708 LIGHTING

## Turn Signals

### A. CUSTOM TOURING FRONT BULLET TURN SIGNAL KIT

Add the lean, stripped-down look of the FLHX models to your Electra Glide® or Road King® motorcycle. Complete kit replaces the Original Equipment passing lamps and flat lens turn signal mounts with streamlined bullet-style turn signals. The chrome-plated brackets serve as stylized mounting points for the turn signals and conceal the wiring for a clean, custom appearance.

**69577-06A** Chrome with Amber Lens. **\$159.95**  
Fits '94-later Road King models. Will not fit models equipped with Non-Vented Fairing Lower.

**69492-05** Chrome with Amber Lens. **\$144.95**  
Fits '96-'13 FLHT and FLHTC, and '05-'13 FLHTCU, FLHTK and FLHTCUTG models. Will not fit vehicles equipped with Non-Vented Fairing Lower.

**67800167** Gloss Black with Smoked Lenses. **\$139.95**  
Fits '96-'13 FLHT, FLHTC, and FLHX and '05-'13 FLHTCU, FLHTK and FLHTCUTG models. Will not fit models equipped with Non-Vented Fairing Lower.



A. CUSTOM TOURING FRONT BULLET TURN SIGNAL KIT – CHROME

### B. BULLET STYLE TURN SIGNAL KIT

Streamline the styling by replacing the front and rear flat lens turn signal lamps with sleek bullet signals. The bullet-shaped housings attach to the Original Equipment turn signal mounting brackets. The kit includes two front and two rear turn signal assemblies and the necessary hardware for installation.

Fits '94-'13 FLHT, FLHTC, and FLHTCU, '94-later FLHR, and FLHRC, '98-'03 FLTR, '96-later FLSTC and '93-'96 FLSTN models.

**69147-03A** **\$139.95**  
Clear Lens and Amber Bulb, Domestic.

**69153-03A** **\$139.95**  
Smoked Lens and Amber Bulb, Domestic.

**69063-03A** **\$139.95**  
Amber Lens and Clear Bulb, Domestic.



A. CUSTOM TOURING FRONT BULLET TURN SIGNAL KIT – GLOSS BLACK



B. BULLET STYLE TURN SIGNAL KIT – FRONT SMOKED LENS



B. BULLET STYLE TURN SIGNAL KIT – REAR SMOKED LENS



B. BULLET STYLE TURN SIGNAL KIT – SMOKED LENS



B. BULLET STYLE TURN SIGNAL KIT – CLEAR LENS

*Notice: The prices appearing in this catalog are the manufacturer's suggested retail prices. Actual retail prices may vary.*



# LIGHTING 709

## Turn Signals



**C. FRONT DIRECTIONAL RELOCATION KIT – CHROME**

### C. FRONT DIRECTIONAL RELOCATION KIT

This kit includes the required hardware and wiring to move the front directional from the handlebar to the lower triple clamp.

Fits '88-later XL (except XL1200T, XL1200X and '11-later XL883L) and '91-'05 Dyna® models (except FXDWG and FXDXT).

<b>68517-94A</b>	Chrome.	<b>\$39.95</b>
<b>68643-09</b>	Gloss Black.	<b>\$34.95</b>

### D. TURN SIGNAL RELOCATION KIT

Styled to blend with the lower triple clamp. This chrome-plated Turn Signal Relocation Kit moves the Original Equipment bullet-style turn signals from the handlebar to the front fork for a clean, streamlined look. Kit includes left and right mounting stalk and all required hardware.

**69433-08A** Chrome. **\$89.95**  
Fits '08-later Dyna models (except FLD and FXDSE/2).

**68564-06** Gloss Black. **\$29.95**  
Fits '06-'07 Dyna models (except FXDSE/2).

**58742-05** Chrome. **\$59.95**  
Fits '93-'05 FXDWG, '86-later FXST, FXSTC, FXSTB and '00-'07 FXSTD models.



**C. FRONT DIRECTIONAL RELOCATION KIT – GLOSS BLACK**



**D. TURN SIGNAL RELOCATION KIT – '08-LATER DYNA**



**D. TURN SIGNAL RELOCATION KIT (68564-06 SHOWN)**



**D. TURN SIGNAL RELOCATION KIT (58742-05 SHOWN)**

#### Model Family Fitment:

<span style="display:inline-block; width:10px; height:10px; background-color:gray; border:1px solid black;"></span> V-ROD	<span style="display:inline-block; width:10px; height:10px; background-color:yellow; border:1px solid black;"></span> SPORTSTER	<span style="display:inline-block; width:10px; height:10px; background-color:red; border:1px solid black;"></span> DYNA
<span style="display:inline-block; width:10px; height:10px; background-color:purple; border:1px solid black;"></span> SOFTAIL	<span style="display:inline-block; width:10px; height:10px; background-color:green; border:1px solid black;"></span> TOURING	

*Notice: The prices appearing in this catalog are the manufacturer's suggested retail prices. Actual retail prices may vary.*

# 710 LIGHTING

## Turn Signals

### A. FRONT TURN SIGNAL RELOCATION KIT FOR FX SOFTAIL® AND DYNA® WIDE GLIDE® MODELS

Allows the relocation of the front turn signal from the handlebar to the front fork, paving the way for use of a variety of custom and flat profile handlebars.

**68952-98 \$69.95**

Fits '84-later FXS, FXST, FXSTB, FXSTC and '93-'05 FXDWG models.



**A. FRONT TURN SIGNAL RELOCATION KIT FOR FX SOFTAIL AND DYNA WIDE GLIDE MODELS**



**B. TURN SIGNAL SWIVEL ASSEMBLY KIT – CHROME**

### B. TURN SIGNAL SWIVEL ASSEMBLY KIT – CHROME

Add a subtle chrome detail to match your own chrome accessories with this swivel kit, a durable stylish replacement for the stock zinc-plated swivel.

**68185-00 \$24.95**

Fits '88-'03 XLH883, XLH883 Hugger®, XL1200S, XL1200C; '88-later FXR, FXRS, FXLR; '91-'08 FXDWG, '91-later FXD, FXDL, FXDX and FXDXT; '88-later FXSTC, FXSTS, FLS, FLSTF, FXST, FXSTB, FXSTD, FXSTSB and '97-'03 FLSTS models. (Does not fit with Turn Signal Relocation Kits or '03 FXSTDSE or '03 FLHRSEI2.)



**C. FRONT TURN SIGNAL MOUNT KIT – CHROME**

### C. FRONT TURN SIGNAL MOUNT KIT – CHROME

Chrome left and right turn signal mounting bracket with swivel adjustment. Fits models equipped with handlebar mounted bullet front turn signals.

**68266-03 \$69.95**

Fits XL (except '04-later XL), Dyna® and Softail® models equipped with handlebar mounted bullet-style turn signals. Stock on '05-later FLSTSC models and '10 FXDWG.



### D. NARROW MOUNTING KIT FOR REAR TURN SIGNALS

Tuck the rear turn signals close to the fender struts. These sleek chrome-plated turn signal mounts move the Original Equipment bullet turn signals 1 inch closer to the rear fender for a custom narrow profile.

**69820-06 \$38.95**

Fits '02-later FXD, FXDC, FXDL, FXDX, FXD35, '07-'08 FXDB, '02-'05 FXDWG models, '02-later FLSTF, FLSTS, FLSTSC models and '02-'05 FXST, FXSTS and FXSTB models. Will not fit with saddlebags or FLD rear light bar.



**D. NARROW MOUNTING KIT FOR REAR TURN SIGNALS**

### E. REAR TURN SIGNAL RELOCATION KIT

Tuck the rear turn signals close to the fender struts. The sleek chrome-plated brackets work with Original Equipment bullet turn signals to add a flowing touch to the fender.

**90395-00 \$49.95** Fits '00-'07 FXSTD models.



**E. REAR TURN SIGNAL RELOCATION KIT**

Notice: The prices appearing in this catalog are the manufacturer's suggested retail prices. Actual retail prices may vary.





**NEW**

**F. BULLET REAR LIGHT BAR – GLOSS BLACK**



**NEW**

67800483

67800484

**F. BULLET REAR LIGHT BAR – GLOSS BLACK**

Complete the “blacked-out” treatment of your custom Touring bike. This complete kit replaces the Original Equipment chrome bar and lamps with a sinister black edition for a minimalistic look. The kit includes the Rear Light Bar with integrated down-lighting for the license plate, bullet lamp housings and wiring.

Fits '06-later Street Glide® and Road Glide® models with Original Equipment rear bullet turn signal light bar.

<b>67800483</b>	Domestic.	<b>\$199.95</b>
<b>67800484</b>	International.	<b>\$399.95</b>

**G. BULLET REAR TURN SIGNAL BAR KIT – CHROME**

Give your bike a new sporting attitude with the Bullet Turn Signal Kit. The chrome-plated bar and bullet turn signal housings provide a custom look and the narrow profile places the signal lamps between the saddlebag and the rear fender for a sleek appearance.

Fits '86-later FLST and FLSTC, '93-'96 FLSTN and '91-'08 Touring models (except '04-later FLHRS and FLTR). Also fits '09-'13 FLHTC, FLHTCU and FLHTK models. Does not fit with Flat Lens Turn Signal Module P/N 91699-99A.

<b>68615-04</b>	Domestic.	<b>\$159.95</b>
<b>68617-04</b>	International.	<b>\$154.95</b>



**G. BULLET REAR TURN SIGNAL BAR KIT – CHROME**



**H. BULLET REAR TURN SIGNAL BAR AND LICENSE PLATE RELOCATION KIT**

Accent the long and lean look of your Touring bike. This complete kit moves your license plate from the support bar to the rear fender tail for a true custom look. The kit includes a Bullet Turn Signal Bar with integrated down-lighting for the license plate, bullet turn signals, chrome rear fender tip and decorative trim to cover the original license plate mounting holes.

**53702-04A** **\$259.95**

Fits '99-'08 Touring models. '99-early '03 models require the separate purchase of Tail Light Socket P/N 68370-03A.



**H. BULLET REAR TURN SIGNAL BAR AND LICENSE PLATE RELOCATION KIT**



**Model Family Fitment:**

<span style="display: inline-block; width: 10px; height: 10px; background-color: gray; border: 1px solid black;"></span> V-ROD	<span style="display: inline-block; width: 10px; height: 10px; background-color: yellow; border: 1px solid black;"></span> SPORTSTER	<span style="display: inline-block; width: 10px; height: 10px; background-color: red; border: 1px solid black;"></span> DYNA
<span style="display: inline-block; width: 10px; height: 10px; background-color: purple; border: 1px solid black;"></span> SOFTAIL	<span style="display: inline-block; width: 10px; height: 10px; background-color: teal; border: 1px solid black;"></span> TOURING	

*Notice: The prices appearing in this catalog are the manufacturer's suggested retail prices. Actual retail prices may vary.*

## 712 LIGHTING

### Turn Signals

#### A. NARROW REAR DIRECTIONAL BAR – CHROME

Enhance the rear profile of your Softail® or Touring model with this Narrow Chrome Directional Bar that enhances the visual proportions of the bike. At 10 inches wide, this die-cast, chrome-plated bar is 3 inches shorter than the stock bar and features the same great quality.

**68611-98** **\$50.95**

Fits '86-later FLST and FLSTC and '93-'96 FLSTN models and '91-'08 Touring models (except '04-later FLHRS and FLTR models). Also fits '09-'13 FLHTC, FLHTCU and FLHTK models. Does not fit with Flat Lens Turn Signal Module P/N 91699-99A.

#### B. REAR DIRECTIONAL MOUNTING BAR – CHROME

Rear directional mounting bar is cast from a very durable zinc-aluminum alloy, has been drilled and tapped for .3125 inch mounting fasteners and is chrome-plated for a beautiful finish. (Lamp assemblies and mounting fasteners not included.)

**68510-74C** **\$74.95**

Fits '86-later FLST and FLSTC, '93-'96 FLSTN and '74-'84 FLH models. Does not fit FLSTS.

#### C. LIGHTED DIRECTIONAL BAR – CHROME\*

Chrome-plated bar provides a custom look with complete integration. LED light pods provide auxiliary lighting for both brake and tail light. NOTE: Must only be used as auxiliary lighting.

**68143-98A** **\$149.95**

Fits '86-later FLSTC, '93-'96 FLSTN; '91-'08 FLT, FLHT, FLHS and FLHR (except FLHRS and FLHX), '09-'13 FLHRC, FLHTC, FLHTCU, FLHTK and '98-'03 FLTR models. Directional Lamps not included.



A. NARROW REAR DIRECTIONAL BAR – CHROME

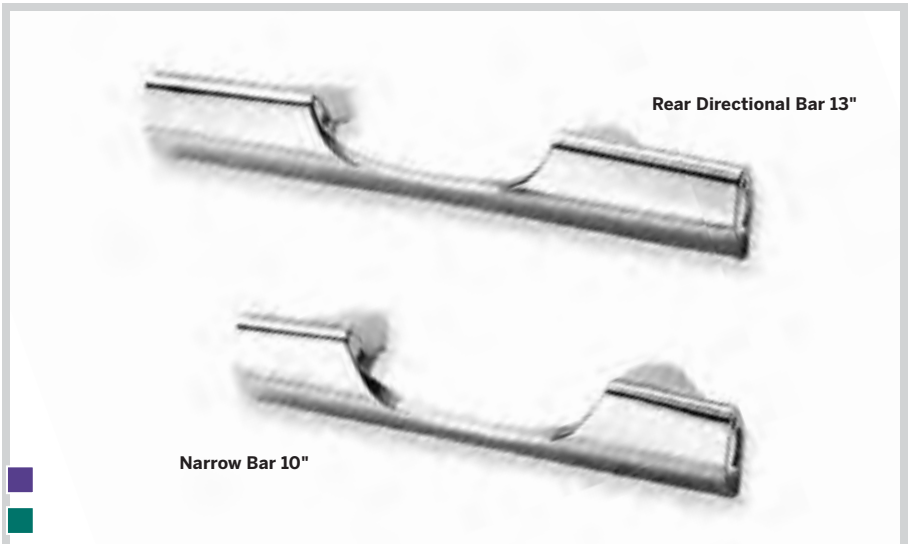

B. REAR DIRECTIONAL MOUNTING BAR – CHROME



C. LIGHTED DIRECTIONAL BAR – CHROME



**\*WARNING:** Disconnecting your DOT requirement brake lamp could reduce your visibility to others and result in death or serious injury.

Notice: The prices appearing in this catalog are the manufacturer's suggested retail prices. Actual retail prices may vary.





**D. AUXILIARY BRAKE LIGHT/RUNNING LIGHT/TURN SIGNAL CONVERSION KIT – FLAT LENS STYLE**



**D. 68000123 SHOWN**



**D. 69461-06C SHOWN**



**D. 69200765 SHOWN**



**D. 69465-06 SHOWN**



**D. 69462-06C SHOWN**



**D. 69463-06A SHOWN**



**E. TOUR-PAK BRAKE LIGHT/RUNNING LIGHT/TURN SIGNAL CONVERSION KIT**

### D. AUXILIARY BRAKE LIGHT/RUNNING LIGHT/TURN SIGNAL CONVERSION KIT\*

Turn signal module adds an auxiliary brake light and running light function to your existing turn signals for auxiliary rear lighting. Red lenses glow when the headlamp is on and increase in intensity when brakes or turn signals are activated. Easy to install, the kit simply plugs into your existing wiring harness. Red turn signal lenses are included. Meets DOT requirements.

**68000123A** Flat Lens Style. **\$69.95**  
Fits '14-later Touring models equipped with Original Equipment flat lens style turn signals.

**69461-06D** Flat Lens Style. **\$69.95**  
Fits '96-later Softail® and '97-'08 Touring models (except FLX) equipped with Original Equipment flat lens style turn signals. Also fits '09-'13 FLHR, FLHRC, FLHTC, FLHTCU and FLHTK models. (Does not fit with Narrow Chrome Directional Bar P/N 68611-98.)

**69200765** Bullet Lens Style. **\$74.95**  
Fits '14-later XL models (except XL883N, XL1200N and XL1200X).

**69465-06** Bullet Lens Style. **\$69.95**  
Fits '00-'07 FXSTD models. (Does not fit with saddlebags.)

**69462-06D** Bullet Lens Style. **\$69.95**  
Fits '02-'03 XL, '02-later Dyna® (except FXDXT and '09-later FXDB and FXDWG) and '02-later Softail (except FXS, FXSB, FXSBSE and FXSTD/I) models with stock bullet-style turn signals. (NOTE: Not intended for use on '04-later FLHX, FLHRS, FLTR or FLHTCSE, '05-later FLSTN models or models equipped with Bullet Turn Signal Bar Kit P/N 68615-04 or 68617-04. If installed on these models, the system will function properly but will not meet the DOT minimum separation requirements for a red tail light to red turn signal.)

**69463-06B** Bullet Lens Style. **\$69.95**  
Fits '04-'13 XL models (except XL883N, XL1200N, XL1200X and '11-later XL1200C).

### E. TOUR-PAK® BRAKE LIGHT/RUNNING LIGHT/TURN SIGNAL CONVERSION KIT\*

Turn signal module adds an auxiliary brake light and turn signal function to your Original Equipment Tour-Pak® rear lighting. Red lenses glow when the headlamp is on and increase in intensity when brakes or turn signals are activated. Easy to install, the kit simply plugs into your existing wiring harness.

**6920042A** **\$74.95**  
Fits '97-'13 FLHTCU, FLHTK, FLTRU, FLHTCUTG and other models equipped with Ultra-style Tour-Pak. (Does not fit '10-'13 FLHTCUSE.)



**\*WARNING:** Disconnecting your DOT requirement brake lamp could reduce your visibility to others and result in death or serious injury.

#### Model Family Fitment:

- V-ROD
- SPORTSTER
- DYNA
- SOFTAIL
- TOURING

*Notice: The prices appearing in this catalog are the manufacturer's suggested retail prices. Actual retail prices may vary.*

# 714 LIGHTING

## Tail & Brake Lamps

### A. LAYBACK LED TAIL LAMP

Shaped to mirror the contour of the rear fender, this Layback LED Tail Light combines style and performance in one. Featuring an array of fast acting red LED lamps arranged in a grid pattern, this bright running lamp outshines traditional incandescent lamps. And when you hit the brakes, you'll grab everyone's attention. Available in your choice of red or smoked finish, this complete tail lamp assembly features an easy plug-in connection to the Original Equipment wiring harness. Lamp meets DOT and TUV requirements.

Fits '99-later XL (except XL883N, XL1200N, XL1200V, XL1200X and '11-later XL1200C), '99-later Dyna® (except '09 FXDB and FXDWG), '03-later FXST, FXSTS, FXSTB and FXSTC, '00-later FLST, FLSTF, FLSTSB and FLSTC and '99-'08 Touring models (except FLHX, FLHTCSE2, FLHRSE3/4 and models equipped with License Plate Relocation Kit P/N 53702-04). Also fits '09-later FLHRC, FLHTC, FLHTCU, FLHTK and FLTRU models.

<b>67800355</b>	Red Lens with Clear License Plate Lamp.	<b>\$159.95</b>
<b>67800356</b>	Smoked Lens with Clear License Plate Lamp.	<b>\$159.95</b>

Fits '06-'09 FLHX, FLHTCSE2 and FLHRSE3/4 models, '09-later FLHR, FLHT and FLTR and models equipped with License Relocation Kit P/N 53702-04.

<b>67800357</b>	Red Lens.	<b>\$159.95</b>
<b>67800358</b>	Smoked Lens.	<b>\$159.95</b>

### B. LED TAIL LAMP

Combine LED technology and contemporary styling for a bright new look. Featuring a full array of 20 fast-acting red LED lamps, this brilliant running and brake lamp will grab everyone's attention. Designed to fit the contour of both Bobtail and full rear fenders, the smoked or red lens Bar & Shield logo-accented tail lamp complements any custom direction. The black or chrome bezel is wrapped in a clear outer housing for a mirror-like finish. Easy plug-in connection to the Original Equipment wiring harness.

Fits '99-later XL (except XL883N, XL1200N, XL1200V, XL1200X and '11-later XL1200C), '99-later Dyna (except '09 FXDB and FXDWG and '14-later FXDF), '03-later FXST, FXSTS, FXSTB and FXSTC, '00-later FLST, FLSTF, FLSTSB and FLSTC and '99-'08 Touring models (except FLHX, FLHTCSE2, FLHRSE3/4 and models equipped with License Plate Relocation Kit P/N 53702-04). Also fits '09-'13 FLHRC and '09-later FLHTC, FLHTCU, FLHTK and FLTRU models.

<b>68085-08</b>	Red Lens/Chrome Bezel.	<b>\$149.95</b>
<b>68087-08</b>	Smoked Lens/Black Bezel.	<b>\$149.95</b>
<b>68086-08</b>	Smoked Lens/Chrome Bezel.	<b>\$149.95</b>

Fits '06-'09 FLHX, FLHTCSE2 and FLHRSE3/4, '09-later FLHR, FLHT and FLTR and models equipped with License Plate Relocation Kit P/N 53702-04.

<b>68117-08</b>	Smoked Lens/Chrome Bezel.	<b>\$149.95</b>
<b>68118-08</b>	Smoked Lens/Black Bezel.	<b>\$149.95</b>
<b>68116-08</b>	Red Lens/Chrome Bezel.	<b>\$149.95</b>

Fits '09-later FLHTCUTG and FLHXXX models. Sold in pairs.

<b>67800133</b>	Red Lens/Chrome Bezel.	<b>\$349.95</b>
<b>67800134</b>	Smoked Lens/Chrome Bezel.	<b>\$349.95</b>
<b>67800135</b>	Smoked Lens/Black Bezel.	<b>\$349.95</b>

Fits '15-later FLRT models. Sold in pairs.

<b>67800457</b>	Red Lens/Chrome Bezel.	<b>\$349.95</b>
<b>67800459</b>	Smoked Lens/Chrome Bezel.	<b>\$349.95</b>



A. LAYBACK LED TAIL LAMP

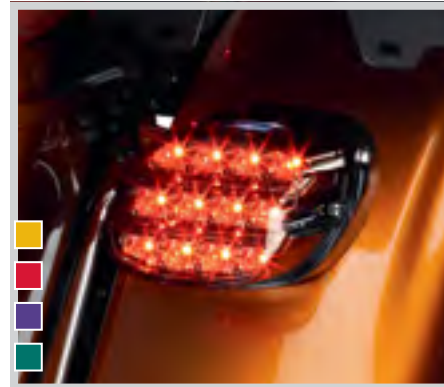
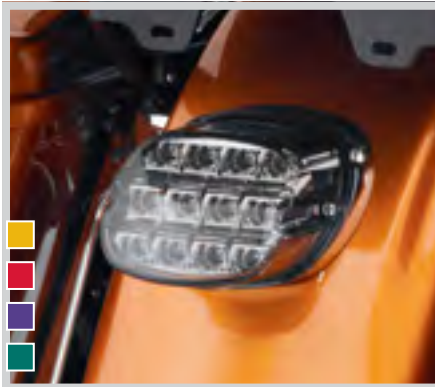

A. LAYBACK LED TAIL LAMP – SMOKED



B. LED TAIL LAMP – SMOKED LENS/ CHROME BEZEL ON

B. LED TAIL LAMP – SMOKED LENS/BLACK BEZEL

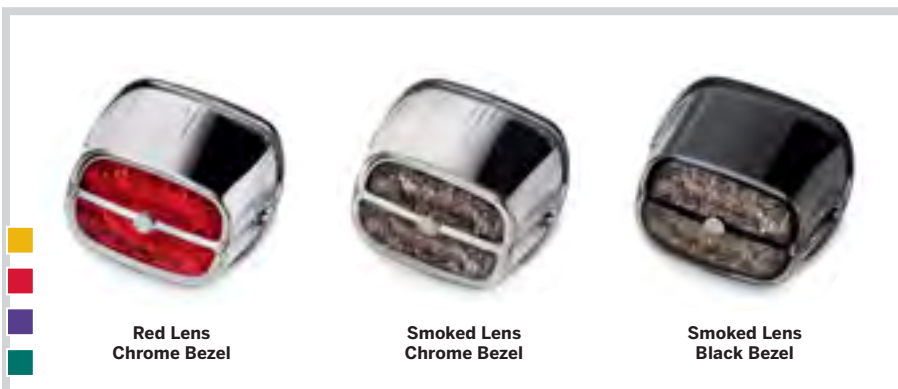

B. LED TAIL LAMPS

#### Model Family Fitment:

- V-ROD
- SPORTSTER
- DYNA
- SOFTAIL
- TOURING

*Notice: The prices appearing in this catalog are the manufacturer's suggested retail prices. Actual retail prices may vary.*



# LIGHTING 715

Tail & Brake Lamps

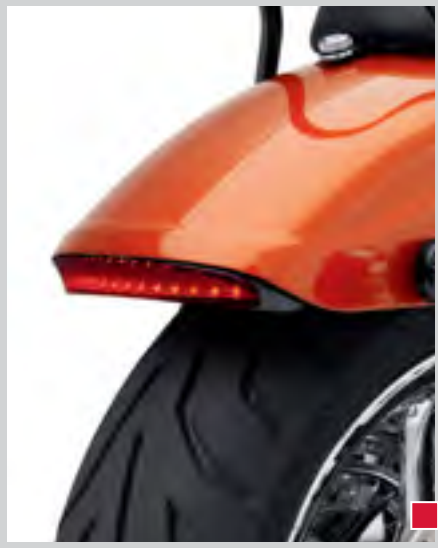

**C. CHOPPED FENDER EDGE LIGHT – DYNA WIDE GLIDE**



**C. CHOPPED FENDER EDGE LIGHT – SPORTSTER**

## C. CHOPPED FENDER EDGE LIGHT

Style and function in one. This center-mount running and brake light commands the attention of following vehicles. The bright, fast-acting LED lamp glows red when the ignition is on and intensifies when the brakes are applied. The low-profile lamp is contoured to hug the curve of the chopped rear fender and adds a stylish touch of color, even when the bike is parked.

**73416-11** Red Lens. **\$89.95**  
Fits '10-later FXDWG models.

**73420-11** Red Lens. **\$89.95**  
Fits '04-'13 XL883N, XL1200N, XL1200V, XL1200X and models equipped with Chopped Rear Fender Kit P/N 60236-XX and side-mount license plate. Will not fit models with center-mount license plates.

**68000105** Red Lens. **\$99.95**  
Fits '14-later XL883N, XL1200V, XL1200X and models equipped with Chopped Rear Fender Kit P/N 60236-XX and side-mount license plate. Will not fit models with center-mount license plates.

## D. TRI-BAR LED TAIL LIGHT

This bobtail fender-styled tail lamp features fast-reacting LED lamps behind a smoked outer lens. Internally masked to form three distinct light bands, the smoked lens glows red in the running mode and rapidly increases in intensity when the brakes are applied. The lamp assembly fills the fender opening for a custom look and the minimalist license plate bracket continues the streamlined appearance. Features easy plug-in connection to the Original Equipment wiring harness. DOT and TUV Approved.

**69817-07A** **\$249.95**  
Fits '06-later FXST, FXSTB, FXSTC, FXSTS and FLSTS models. Original Equipment on '07-'08 FXSTSSE models. Will fit with Bobtail Fender Racks P/N 53979-07A and 56452-07A when used with Installation Kit P/N 59320-07A. Does not fit with Bobtail Fender Rack P/N 56452-07, 60161-06 or 53979-07.

**68546-09** **\$249.95**  
Fits '08-'13 FXDF models. Original Equipment on FXDFSE.

## E. SISSY BAR AUXILIARY BRAKE AND TAIL LAMP\*

This high-mounted Sissy Bar Auxiliary LED Lamp operates as a supplemental rear running light and brake light. The one-piece lamp assembly features an upper and lower arc-shaped lens that surrounds the sissy bar medallion plate and the fast-acting LED lamp produces a red neon-like glow that is bound to get you noticed. The kit includes an adapter harness that connects to the vehicle wiring harness and features a quick-disconnect that allows a H-D® Detachables™ sissy bar to be easily removed from the vehicle.

Fits '99-'13 XL, and '96-later Dyna® and Softail® models equipped with a Medallion Plate-Style Sissy Bar Upright. Will not fit with Backrest Pads that have mounting brackets that match the contour of the sissy bar medallion. Will not fit with sissy bar mounted storage bags. Some Touring and Bucket Backrest pads require separate purchase of Sissy Bar Lamp Mounting Bracket Kit P/N 59545-04.

**59470-06A** Smoked Lens. **\$99.95**

**59429-04A** Red Lens. **\$99.95**

Fits '14-later XL models equipped with a Medallion Plate-Style Sissy Bar Upright. Will not fit with Backrest Pads that have mounting brackets that match the contour of the sissy bar medallion. Will not fit with sissy bar mounted storage bags.

**68000107** Red Lens. **\$99.95**

**68000106** Smoked Lens. **\$99.95**

### Sissy Bar Lamp Mounting Bracket Kit (not shown)

Required to install Sissy Bar Auxiliary Brake and Tail Lamp on models equipped with Touring and Bucket Passenger Backrest P/N 51667-98, 51132-98, 51130-98, 52348-97, 52347-97 or 52350-97.

**59545-04** **\$29.95**



**D. TRI-BAR LED TAIL LIGHT – OFF**



**D. TRI-BAR LED TAIL LIGHT – ON**

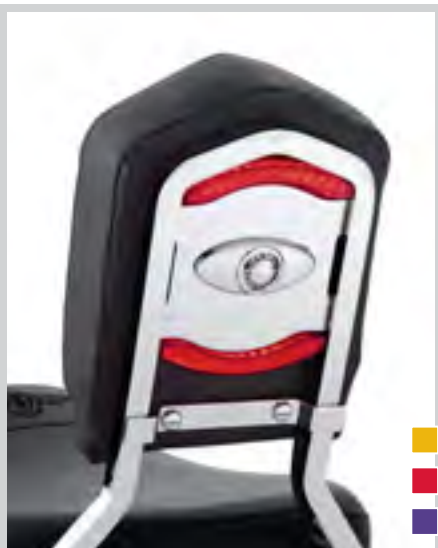

**E. SISSY BAR AUXILIARY BRAKE AND TAIL LAMP – RED LENS**



**E. SISSY BAR AUXILIARY BRAKE AND TAIL LAMP – SMOKED LENS**



**\*WARNING:** Disconnecting your DOT requirement brake lamp could reduce your visibility to others and result in death or serious injury.

Notice: The prices appearing in this catalog are the manufacturer's suggested retail prices. Actual retail prices may vary.

# 716 LIGHTING

## Tail & Brake Lamps

### A. ELECTRA GLO™ LED SADDLEBAG RUN/BRAKE/TURN LAMP\*

Add functional lighting to the rear of your Touring bike. These running, directional and brake lights command the attention of following vehicles. The bright, fast-acting LED lamps glow red when the ignition is on and intensify when the turn signals or brakes are activated. The lamps act as a supplement to the Tour-Pak® luggage mounted rear lighting. The lamps are housed in a low-profile chrome frame that is contoured to hug the curve of the hard saddlebags. The self-adhesive lamps fit seamlessly beneath the saddlebag lid and add a stylish touch of color, even when the bike is parked. Complete kit includes left and right lamps, modulator and quick-disconnect wiring harness.

Fits '14-later FLHTCU, FLHTCUL, FLHTK and FLHTKL models. Does not fit FLHTKSE or FLTRUSE.

<b>67800241</b>	Red Lens.	<b>\$209.95</b>
<b>67800242</b>	Smoked Lens.	<b>\$209.95</b>

Fits '14-later FLHX, FLHXS, FLTRX and FLTRXS models. Does not fit Canadian models.

<b>67800448</b>	Red Lens.	<b>\$209.95</b>
<b>67800450</b>	Smoked Lens.	<b>\$209.95</b>

Fits '14-later FLHR models with hard saddlebags. Also fits FLHTKSE, FLHRSE, FLTRUSE and Canadian FLHX, FLHXS, FLTRX and FLTRXS models.

<b>67800449</b>	Red Lens.	<b>\$209.95</b>
<b>67800451</b>	Smoked Lens.	<b>\$209.95</b>



A. ELECTRA GLO LED SADDLEBAG RUN/BRAKE/TURN LAMP



A. ELECTRA GLO LED SADDLEBAG RUN/BRAKE/TURN LAMP – RED LENS



A. ELECTRA GLO LED SADDLEBAG RUN/BRAKE/TURN LAMP – SMOKED LENS



**\*WARNING:** Disconnecting your DOT requirement brake lamp could reduce your visibility to others and result in death or serious injury.

#### Model Family Fitment:

- V-ROD
- SPORTSTER
- DYNA
- SOFTAIL
- TOURING

*Notice: The prices appearing in this catalog are the manufacturer's suggested retail prices. Actual retail prices may vary.*





**B. LED KING TOUR-PAK BRAKE/TURN/TAIL LAMP KIT – SMOKED LENS**

**B. LED KING TOUR-PAK® BRAKE/TURN/TAIL LAMP KIT – SMOKED**

Add a sinister touch to the rear of your bike. This smoked LED lamp kit is a direct plug-in replacement for the stock LED red lens wrap-around Tour-Pak® light. The bright fast-acting LEDs glow bright red when activated, but nearly disappear behind the dark smoke lens when off. The lamp features a flat black surround that complements any solid or two-tone paint color and accommodates single and dual-antenna applications. No cutting or splicing is required for installation.

**67800368** Smoked Lens. **\$299.95**  
Fits '14-later FLHTCU, FLHTCUL, FLHTK, FLHTKL and FLHTCUTG models.



**C. LED KING TOUR-PAK BRAKE/TURN/TAIL LAMP KIT – SMOKED LENS**



**C. LED KING TOUR-PAK BRAKE/TURN/TAIL LAMP KIT – RED LENS**

**C. LED KING TOUR-PAK BRAKE/TURN/TAIL LAMP KIT\***

Add high-mount turn signals, running and brake lamps to your Classic and Ultra King Tour-Pak luggage. This wrap-around light kit is equipped with bright, fast-acting LED lamps that grab the attention of following traffic. The corner lights operate in run/brake/turn mode and the center lamp functions as a run and brake lamp. The slim-line design mounts to the exterior surface of the Tour-Pak and can be used to replace the Original Equipment Ultra-style lamp. When equipped with Tour-Pak Liner P/N 53302-07 (sold separately), this kit eliminates the interior bulges and maximizes the carrying capacity inside. Available with smoked or red lens, the lamp features a flat black surround that complements any solid or two-tone paint color. Kit accommodates single and dual-antenna applications. No cutting or splicing is required for installation and kit includes a simple drilling template, interior mounting plates, mounting hardware and wiring harness.

Fits '97-'13 Touring models (except CVO™) equipped with King Tour-Pak luggage.

**67931-11** Smoked Lens. **\$499.95**  
**67932-11** Red Lens. **\$499.95**



**D. TOUR-PAK SIDE MARKER LIGHT KIT – SMOKED LENS**



**D. TOUR-PAK SIDE MARKER LIGHT KIT – RED LENS**

**D. TOUR-PAK SIDE MARKER LIGHT KIT**

This wrap-around Side Marker Light Kit adds a splash of light to the lower edge of the Tour-Pak Luggage System. Kit replaces the chrome side trim along the lower edge of the Tour-Pak on Electra Glide® Classic models or replaces the Original Equipment red lens featured on Ultra Classic® Electra Glide and Tri Glide® models. Available in your choice of red or smoked lens. The smoked lens remains stealthy while the ignition is off, but glows red when the lights are switched on. Complete kit includes left and right lens housings, wiring harness and all required installation hardware.

**54352-09** Smoked Lens. **\$119.95**  
Fits '06-later FLHTC, FLHTCU, FLHTCUTG, FLHTK and Touring models equipped with '06-later-style King Tour-Pak luggage.

**69494-06** Red Lens. **\$119.95**  
Fits '06-later FLHTC and Touring models equipped with '06-later-style King Tour-Pak luggage. Original Equipment on the '06-later FLHTCU, FLHTK and FLHTCUTG models.

**E. KING TOUR-PAK BRAKE/TAIL LAMP KIT\***

Dual filament bulbs provide both brake and tail lamp. Meets DOT requirements. Includes template to assist in cutting out lens housing openings, step-by-step instructions, wiring and all necessary mounting hardware. Dealer installation recommended.

**68172-06** **\$239.95**  
Fits '06-'13 King Tour-Pak. (NOTE: Kit accommodates single antenna applications.)

**68012-88E** **\$239.95**  
Fits '88-'05 King Tour-Pak. (NOTE: Kit accommodates single antenna applications.)

NOTE: Original Equipment on Ultra Classic Models.



**E. KING TOUR-PAK BRAKE/TAIL LAMP KIT**



**\*WARNING:** Disconnecting your DOT requirement brake lamp could reduce your visibility to others and result in death or serious injury.

Notice: The prices appearing in this catalog are the manufacturer's suggested retail prices. Actual retail prices may vary.

# 718 LIGHTING

## Decorative LED Lighting

### A. ELECTRA GLO™ SADDLEBAG SIDE MARKER LIGHT KIT

This wrap-around Side Marker Light Kit adds a splash of light to the lower edge of the color-matched saddlebags. Available in your choice of red or smoked lens, the bright band of LED lamps is housed in a mirror chrome frame that hugs the bottom of the saddlebag. The low-profile self-adhesive Electra Glo™ lamps can be installed on models equipped with standard-length saddlebags and are compatible with optional saddlebag guard rails. Easy to install kit includes left and right lamp and quick-disconnect wiring harness.

Fits '14-later Touring models with hard saddlebags. Not compatible with CVO™ or other models equipped with Stretched Saddlebags. Installation requires separate purchase of Electrical Connection Update Kit P/N 69200722.

<b>68000082</b>	Red Lens.	<b>\$249.95</b>
<b>68000083</b>	Smoked Lens.	<b>\$249.95</b>

### B. ELECTRA GLO LIGHT RAILS\*

Molded housings incorporate wave-soldered circuit boards with tungsten filament bulbs for enhanced illumination. Precision-molded Lexan® polycarbonate lenses lined with light-diffusing panels offer consistent, even light dispersion. Assembled and wired for bolt-on and plug-in installation. Kit includes bracketry, hardware and instructions.

<b>68682-09</b>	<b>\$599.95</b>
-----------------	-----------------

Fits '09-'13 Road King®, Street Glide® and Electra Glide® models equipped with hard saddlebags. Installation on models not factory-equipped with saddlebag guards requires separate purchase of Saddlebag Guard Rail Kit P/N 90892-09.

<b>90531-93</b>	<b>\$579.95</b>
-----------------	-----------------

Fits '94-'08 FLTCU, FLHTCU and FLHTC and '98-'03 FLTR models. Will not fit '06-'08 FLHX models.

NOTE: Installation on '93 FLHS and '94-'96 FLHR models requires Saddlebag Guard Kit P/N 90839-93A, installation on '97-later FLHT and FLHR (except '98-later FLHRC and FLHRS) models requires Saddlebag Guard Kit P/N 91216-97. Must be purchased separately. To install on '93-'96 models equipped with accessory Triple Saddlebag Rail Kit P/N 90845-93A, Left and Right Outer Guard Rail Clamps P/N 90919-93 and P/N 90917-93 are required and must be purchased separately.



A. ELECTRA GLO SADDLEBAG SIDE MARKER LIGHT KIT – RED LENS



A. ELECTRA GLO SADDLEBAG SIDE MARKER LIGHT KIT – SMOKED LENS

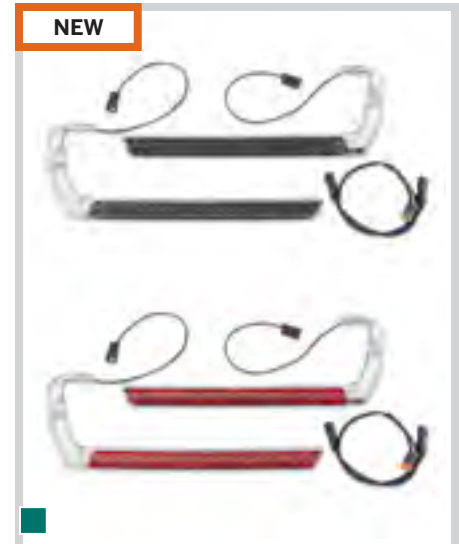

A. ELECTRA GLO SADDLEBAG SIDE MARKER LIGHT KIT – RED AND SMOKED LENS



B. ELECTRA GLO LIGHT RAILS

\*NOTE: It is possible to overload your motorcycle's charging system by adding too many electrical accessories. If your combined electrical accessories operating at any one time consume more electrical current than your vehicle's charging system can produce, the electrical consumption can discharge the battery and cause vehicle electrical system damage. Ask your dealer for advice about the amount of current consumed by additional electrical accessories.

#### Model Family Fitment:

 V-ROD	 SPORTSTER	 DYNA
 SOFTAIL	 TOURING	

Notice: The prices appearing in this catalog are the manufacturer's suggested retail prices. Actual retail prices may vary.





**C. CENTER-MOUNT AUXILIARY RUNNING & BRAKE LIGHT**



**C. CENTER-MOUNT AUXILIARY RUNNING AND BRAKE LIGHT**

Brilliant red center-mount running and brake light grabs the attention of following vehicles. The fast-acting long life LEDs glow red when ignition is on and intensify when the brakes are applied. The low-profile chrome shell attaches to and hugs the contour of the turn signal bar for a custom look. Plug-in connection for easy installation.

**68000029** **\$129.95**  
Fits '10-'13 FLHX and FLTRX models.

**68000119** **\$129.95**  
Fits '14-later FLHX, FLHXS, FLTRX and FLTRXS models.

**D. LED FENDER TIP LENS – SMOKED**

Add a custom look to the fender tip lens on your bike. Smoked lenses replace the Original Equipment lenses and self-contained LED lamp replaces the bulb.

**59338-09** Front Fender. **\$23.95**  
Fits '80-'13 FLHT, FLT, FLHS and FLHR, '86-'08 FLSTC and '93-'96 FLSTN models. Does not fit models with clean front fender.

**59336-09** Rear Fender. **\$23.95**  
Fits '80-'08 FLHT, FLT, FLHS and FLHR, '86-'08 FLSTC and '93-'96 FLSTN models.

**59380-05** Front and Rear Fender. **\$44.95**  
Fits '80-'08 FLHT, FLT, FLHS and FLHR, '86-'08 FLSTC and '93-'96 FLSTN models. Does not fit FLST, FLSTS, FLSTSB, FLSTSC, FLHRS, FLHX and FLTR or models equipped with clean front fender.



**D. LED FENDER TIP LENS – SMOKED FRONT FENDER**



**D. LED REAR TIP LENS – SMOKED REAR FENDER**

**E. REAR FENDER TIP LIGHT – AUXILIARY RUNNING LIGHT/BRAKE LIGHT\***

Upgrade your Touring model's Original Equipment fender tip light from a single-mode running light to a dual-mode running and brake light. The brilliant lamp glows red in the running mode and increases in intensity when the brakes are applied. The available smoked or red lenses complement any styling direction. Easy plug-in connection to the Original Equipment wiring harness.

Fits '09-later FLHTC, FLHTCU, FLHTCUL, FLHTK and FLHTKL models.

**59685-10** Red Lens. **\$99.95**

**59776-10** Smoked Lens. **\$99.95**



**E. REAR FENDER TIP LIGHT – AUXILIARY RUNNING LIGHT/BRAKE LIGHT**



**F. TRI-BAR LIGHTED REAR FENDER EXTENSION KIT\***

Add a "tail-dragger" look to the rear fender. The Tri-Bar Rear Fender Extension wraps the trailing edge of the fender in chrome and the integrated Tri-Bar LED light bands add a practical touch. The three smoked light bands glow red in the running mode and increase in intensity when the brakes are applied. The complete kit includes the chrome-plated ABS housing, fast-acting LED lamp assembly and all necessary installation hardware.

**91066-07** **\$189.95**  
Fits '99-'08 FLHRC, FLHRS and FLTR models.

**91067-07** **\$189.95**  
Fits '99-'08 FLHR, FLHT, FLHTC and FLHTCU models. (Does not fit FLHRSE2/3/4 models.)



**F. TRI-BAR LIGHTED REAR FENDER EXTENSION KIT**



**G. TRI-BAR LIGHT UPGRADE – AUXILIARY RUNNING LIGHT/BRAKE LIGHT**

**G. TRI-BAR LIGHT UPGRADE – AUXILIARY RUNNING LIGHT/BRAKE LIGHT\***

Upgrade the Original Equipment Tri-Bar fender light from a single-mode running light to a dual-mode running and brake light. The three smoked light bands glow red in the running mode and increase in intensity when the brakes are applied.

**68358-07A** **\$99.95**  
Fits '06-'09 FLHX models.

**67774-10** **\$139.95**  
Fits '10-later FLHX and FLTRX models (except HDI models).



**\*WARNING:** Disconnecting your DOT requirement brake lamp could reduce your visibility to others and result in death or serious injury.

Notice: The prices appearing in this catalog are the manufacturer's suggested retail prices. Actual retail prices may vary.

## STEP INTO THE LIGHT

Believe it or not, chrome isn't the brightest accessory you can use to customize your ride. Harley-Davidson® offers a variety of lighting options that can add the perfect finishing touch to nearly any part of your bike.



This Road King® Classic model is equipped with amber Electra Glo™ Rider Footboard Inserts, an amber Electra Glo Light Pod Starter Kit and four Light Pod Expansion Kits.



### A. ELECTRA GLO™ LIGHT POD KIT\*

Light up the night. These compact LED Light Pods radiate a neon-like glow to accent almost any part of the motorcycle. Featuring a solid-state circuit board sealed against the weather, these self-adhesive lights can be placed under the tank, behind the air cleaner or almost anywhere your imagination takes you. Electra Glo™ LED lighting draws minimal amperage, allowing lights to be left on for hours when parked. Light Pods connect directly to the motorcycle wiring harness and the one-way wiring simplifies installation.

The complete kit includes 6 light pods, basic wiring in a selection of lengths, adhesive wire ties and a compact on/off switch with rheostat to control the lighting intensity. Available Expansion Kits provide plug-in installation of additional lighting.

Fits all models. Lights are intended for display use only. Some local regulations prohibit using colored lights during vehicle operation on public streets.

<b>67679-09</b>	Amber.	<b>\$174.95</b>
<b>67680-09</b>	Red.	<b>\$174.95</b>
<b>67695-09</b>	Blue.	<b>\$194.95</b>
<b>67701-09</b>	Purple.	<b>\$199.95</b>

### Also available:

#### ELECTRA GLO LIGHT POD EXPANSION KIT\*

Highlight additional areas of your custom motorcycle. Expansion Kit features simple plug-in installation to the basic Electra Glo Light Pod Kit. Kit contains 4 Light Pods and basic wiring assortment.

<b>67610-09</b>	Amber.	<b>\$124.95</b>
<b>67620-09</b>	Red.	<b>\$124.95</b>
<b>67671-09</b>	Blue.	<b>\$134.95</b>
<b>67678-09</b>	Purple.	<b>\$134.95</b>

\*NOTE: It is possible to overload your motorcycle's charging system by adding too many electrical accessories. If your combined electrical accessories operating at any one time consume more electrical current than your vehicle's charging system can produce, the electrical consumption can discharge the battery and cause vehicle electrical system damage. Ask your dealer for advice about the amount of current consumed by additional electrical accessories.

NOTE: Some local regulations prohibit using colored lights during vehicle operation on public streets. May not conform to local lighting regulations.





Purple



Red



Blue



Amber



Off

### B. ELECTRA GLO FOOTBOARD INSERTS – RIDER

### B. ELECTRA GLO™ FOOTBOARD INSERTS

Attract a crowd. The Electra Glo™ Footboard Inserts feature a molded rubber insert that appears to be charcoal black in normal operation, with a mirror-chrome surround and Bar & Shield logo as a finishing touch. But when the bike is parked and the ignition is turned to the accessory setting—watch out. The surface explodes with brilliant LED lamps, washing the surface in light and reflecting off of the chrome engine and exhaust trim. The effect is magical and hard to match with “neon” strips. Available with blue, red, purple or amber LEDs, the colors are tinted to match the available Electra Glo Light Pods. Inserts fit traditional D-shaped footboards and are easy to install with pre-terminated wiring that plugs into the factory harness. No cutting or splicing is necessary.

NOTE: Some local regulations prohibit using colored lights during vehicle operation on public streets. May not conform to local lighting regulations.

### ELECTRA GLO FOOTBOARD INSERTS – RIDER

Fits '86-later Touring and Trike models with traditional D-shaped rider footboards. '14-later Touring and Trike models require separate purchase of Wiring Harness P/N 69200722.

<b>50745-10</b>	Red.	<b>\$209.95</b>
<b>51080-10</b>	Amber.	<b>\$209.95</b>
<b>51082-10</b>	Blue.	<b>\$209.95</b>
<b>51130-10</b>	Purple.	<b>\$209.95</b>

### ELECTRA GLO FOOTBOARD INSERTS – PASSENGER

Fits '94-later Touring and Trike models with D-shaped passenger footboards. Passenger Inserts must be installed in conjunction with Rider Inserts. '14-later Touring and Trike models require separate purchase of Wiring Harness P/N 69200722.

<b>51287-10</b>	Red.	<b>\$179.95</b>
<b>51289-10</b>	Amber.	<b>\$179.95</b>
<b>51291-10</b>	Blue.	<b>\$179.95</b>
<b>51304-10</b>	Purple.	<b>\$179.95</b>



Purple

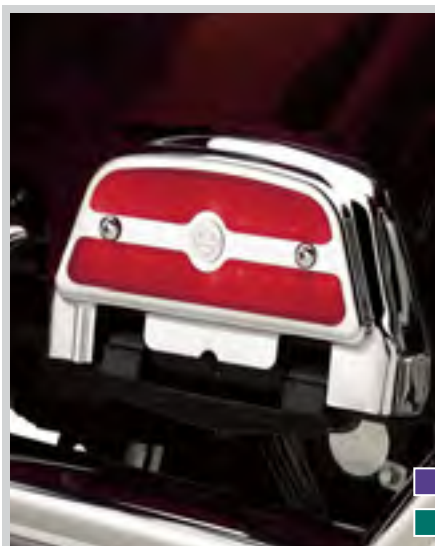

### C. ELECTRA GLO LIGHTED PASSENGER FOOTBOARD COVER KIT

### C. ELECTRA GLO LIGHTED PASSENGER FOOTBOARD COVER KIT

This innovative LED light kit covers the bottom side of the passenger footboard. When the passenger footboard is folded in the up position, the light will shine to the side and act as an auxiliary side marker light. When the board is folded down, the light illuminates the ground with a pool of soft light. Kit includes a pair of LED lamps with red lenses, chrome covers with Bar & Shield logo, chrome hardware and all necessary installation components.

NOTE: Some local regulations prohibit using colored lights during vehicle operation on public streets. May not conform to local lighting regulations.

**50541-03A** **\$179.95**

Fits '84-later Softail®, Touring and Trike models equipped with traditional D-shaped passenger footboards. '14-later Touring and Trike models require separate purchase of Wiring Harness P/N 69200722.

### B. ELECTRA GLO FOOTBOARD INSERTS – PASSENGER



### D. ELECTRA GLO RIDER FOOTBOARD EDGE LIGHT KIT

### D. ELECTRA GLO RIDER FOOTBOARD EDGE LIGHT KIT

Add a rim of neon-like light to the rider footboard. This integrated red LED light and lens assembly hugs the bottom of the rider footboard and is held in place by the footboard insert isolation mounting system. The soft red glow acts as an auxiliary side marker light and casts a subtle pool of light to the ground below. The perfect complement to the Electra Glo Lighted Passenger Footboard Cover P/N 50541-03A. Kit includes left and right footboard lights, wiring harness and all necessary installation components.

NOTE: Some local regulations prohibit using colored lights during vehicle operation on public streets. May not conform to local lighting regulations.

**50743-04** **\$109.95**

Fits '91-later FLSTF, FLSTS and FLSTSC, '91-'09 FLSTC, '93-'96 FLSTN and '94-later Touring and Trike models equipped with traditional D-shaped rider footboards. '14-later Touring and Trike models require separate purchase of Wiring Harness P/N 69200722.

#### Model Family Fitment:

 V-ROD	 SPORTSTER	 DYNA
 SOFTAIL	 TOURING	

Notice: The prices appearing in this catalog are the manufacturer's suggested retail prices. Actual retail prices may vary.

## 722 LIGHTING

LED Decorative Lighting

### A. ELECTRA GLO™ LIGHT RINGS

Capture the attention of everyone you pass. These euro-inspired Electra Glo™ Light Rings add a dramatic visual element to the front of your bike. Featuring a brilliant arc of individual white LED lamps, these rings add a distinctive look that defines your style. Sized to fit headlamp and auxiliary lamps on a wide variety of models, the Light Rings are available in chrome and black finishes to complement your customizing direction.

Fits '12-later Dyna® FLD, '83-later Touring (except Tour Glide™ and Road Glide®) and '09-later Trike models. Also fits '86-later Softail® models with Freight Train Headlamp Nacelle. Softail models require separate purchase of Wiring Harness P/N 69200602. '14-later FLHR models require the separate purchase of Harness Kit P/N 69200850. '14-later Electra Glide®, Street Glide® and Tri Glide® models require separate purchase of Fairing Power Extension Harness P/N 69200921 if installed with Boom!™ Audio Hidden AM/FM/WB Antenna P/N 76000513 or Electra Glo Fairing Edge Lights.

<b>61400152A</b>	7" Headlamp, Chrome.	<b>\$114.95</b>
<b>61400153A</b>	7" Headlamp, Gloss Black.	<b>\$114.95</b>

Fits '94-later FLS, FLST, FLSTC, FLSTF, FLSTFB and FLSTN models. Does not fit models with Headlight Nacelle.

<b>61400154</b>	7" Headlamp, Chrome.	<b>\$114.95</b>
<b>61400155</b>	7" Headlamp, Black.	<b>\$114.95</b>

Fits '83-later Touring (except Tour Glide and Road Glide), '08-later Trike and '97-later Softail models equipped with original equipment or accessory auxiliary lights. Fits '96-later Dyna and '04-later Sportster® models equipped with accessory auxiliary lights. '14-later FLHR models require the separate purchase of Harness Kit P/N 69200850 (if not already installed for a 7" ring). '14-later Electra Glide, Street Glide and Tri Glide models require separate purchase of Fairing Power Extension Harness P/N 69200921 if installed with Boom!™ Audio Hidden AM/FM/WB Antenna P/N 76000513 or Electra Glo Fairing Edge Lights. Does not fit with lamp visors.

<b>61400094</b>	4" Auxiliary Lamp, Chrome.	<b>\$174.95</b>
<b>61400141</b>	4" Auxiliary Lamp, Black.	<b>\$174.95</b>

Also available: (not shown)

#### ELECTRA GLO HEADLAMP TRIM WIRING HARNESS

Required when installing 7" Electra Glo Light Rings on '97-later FL Softail models equipped with Headlight Nacelle.

<b>69200602</b>	<b>\$9.95</b>
-----------------	---------------

Required when installing 7" and 4" Electra Glo Light Rings on '14-later FLHR models.

<b>69200850</b>	<b>\$14.95</b>
-----------------	----------------



A. ELECTRA GLO LIGHT RINGS (SHOWN WITH ELECTRA GLO FAIRING EDGE LIGHTS)



A. ELECTRA GLO LIGHT RINGS



A. ELECTRA GLO LIGHT RINGS



A. ELECTRA GLO LIGHT RINGS

Notice: The prices appearing in this catalog are the manufacturer's suggested retail prices. Actual retail prices may vary.



# LIGHTING 723

LED Decorative Lighting



**B. ELECTRA GLO FAIRING EDGE LIGHT KIT**

## **B. ELECTRA GLO™ FAIRING EDGE LIGHT KIT**

Amplify your ride. The Electra Glo™ Fairing Edge Light kit adds forward-facing white LED accent lights to the front profile of your bike. Formed to follow the contour of the batwing fairing, the slim strip of lamps adds a strong visual element to the iconic shape of the Electra Glide® model. The electrifying appearance adds conspicuity to get you noticed and the smoked housing conceals the lights and blends into the background when switched off. Simple "plug in" connections with no cutting or splicing of wires required.

**68000104** **\$99.95**

Fits '14-later Electra Glide, Street Glide® and Tri Glide® models. Separate purchase of Fairing Power Extension Harness P/N 69200921 is required if installed with Boom!™ Audio Hidden AM/FM/WB Antenna P/N 76000513 or Electra Glo Light Rings.

**68000035** **\$99.95**

Fits '96-'13 Electra Glide, Street Glide and Trike models.

## **C. ILLUMINATED FAIRING ACCENT TRIM**

Sweeping chrome trim dresses the Electra Glide fairing for a distinctive, yet functional look. Smoked lenses hide amber LED lamps that glow as running lamps when the ignition is on and function as auxiliary directional indicators when the turn signals are activated. The wiring is concealed inside the fairing for a clean, custom appearance. Complete kit includes all necessary installation hardware. Trim may cover pinstripes or two-tone paint lines on some vehicles. Check appearance prior to installation.

**69290-09** **\$199.95**

Fits '97-'13 Electra Glide, Street Glide and Trike models.

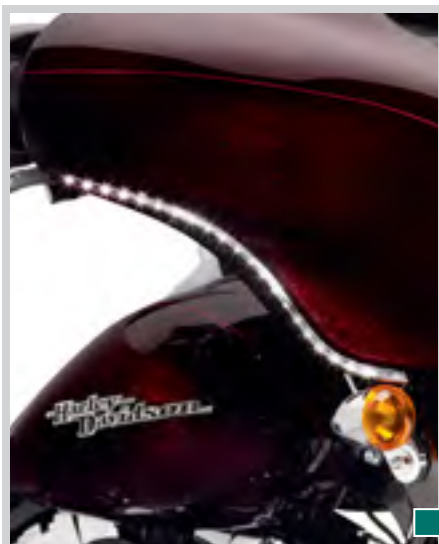

**B. ELECTRA GLO FAIRING EDGE LIGHT KIT**



**B. ELECTRA GLO FAIRING EDGE LIGHT KIT**



**C. ILLUMINATED FAIRING ACCENT TRIM**

### Model Family Fitment:

- V-ROD
- SPORTSTER
- DYNA
- SOFTAIL
- TOURING

Notice: The prices appearing in this catalog are the manufacturer's suggested retail prices. Actual retail prices may vary.

# 724 LIGHTING

## Headlamp Trim

### A. TRIM RING COLLECTION

This chrome-plated Headlamp Trim Ring extends forward, giving the headlamp assembly a "frenched" look reminiscent of classic hot rod car designs by recessing the headlamp and adding the appearance of depth. Functions as a direct replacement for the Original Equipment trim ring, except when used with P/N 69627-99, where it easily installs over the Original Equipment trim ring. (Does not fit with Accessory Headlamp Visor or Passing Lamp Visor.)

**1. 69627-99** Headlamp. **\$37.95**  
Fits '83-'13 Touring (except Tour Glide™ and Road Glide®), '08-'13 Trike, '12-later FLD and '94-later Road King® models. Also fits '86-later FL Softail® models with Headlight Nacelle. (Does not fit with Fairing Bra P/N 57800-00.)

**2. 69622-99B** Passing Lamp. **\$54.95**  
Fits '62-later models equipped with Original Equipment or accessory Auxiliary Lamp Kits. Sold in pairs.

**3. 69740-01** Turn Signal – Flat Lens. **\$41.95**  
Fits flat lens turn signals on front and rear of '14-later FLHR and FLHRC, '88-'13 Touring (except FLHX, FLHRS, and '04-'13 FLTR), rear of '94-later FLSTC, '94-'97 FLSTN and '06 FLST models. Also fits FL Softail models with front Turn Signal Relocation Kit P/N 68413-99 or 68412-99.

**67700215** Headlamp. **\$39.95**  
Fits '14-later Electra Glide®, Street Glide® and Tri Glide® models.

**69626-99** Headlamp. **\$37.95**  
Fits '94-later FLS, FLST, FLSTC, FLSTF and FLSTN models. Also fits '15-later FLRT models.

**69623-99A** Headlamp. **\$32.95**  
Fits '94-99 FXSTC, '94-later FXLR, FXST, FXSTB, '94-later Dyna® (except FXDF and FLD equipped with 7" headlamp) and '04-later XL883, XL1200L, XL883L, XL883N, XL883R, XL1200N, XL1200X and XL1200R and '05 VRSCB models. Also fits '08-later FLSTSB and FXS models.

**69624-99A** Headlamp. **\$32.95**  
Fits '07-later FXSTC, '96-later XL1200C, XL1200V, XL883C, '99 FXR, '93-later FXSTS, '95-'97 FXSTSB, '97-'03 FLSTS, '05-later FLSTSC and '00-'07 FXSTD models.



**A. TRIM RING COLLECTION  
(HEADLAMP, PASSING LAMP AND TURN SIGNAL TRIM RINGS) – ROAD KING**

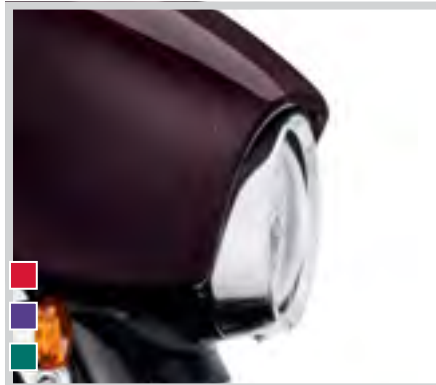

**A. HEADLAMP TRIM RING – ELECTRA GLIDE**



**A. HEADLAMP TRIM RING – SOFTAIL STANDARD**



**A. HEADLAMP TRIM RING – DYNA LOW RIDER**



**A. HEADLAMP TRIM RING – XL883 LOW**

*Notice: The prices appearing in this catalog are the manufacturer's suggested retail prices. Actual retail prices may vary.*



# LIGHTING 725

Headlamp Trim



**B. VISOR STYLE TRIM RING COLLECTION  
(HEADLAMP, PASSING LAMP AND TURN SIGNAL TRIM RINGS) – ROAD KING**

## B. VISOR STYLE TRIM RING COLLECTION

These chrome-plated Visor Style Trim Rings recess the headlamp into the housing and add a traditional "eyebrow" design to the headlamp shell. The trim ring stretches the profile of the bike for a long, lean appearance. Add matching Visor Style Passing Lamp and Turn Signal Trim Rings for a true custom look.

**1. 69733-05** Headlamp. **\$43.95**

Fits '83-'13 Touring (except Tour Glide™ and Road Glide®), '08-'13 Trike, '12-later FLD and '94-later Road King® models. Also fits '86-later FL Softail® models with Headlight Nacelle. (Does not fit with Fairing Bra P/N 57800-00.)

**2. 69732-05** Passing Lamp. **\$59.95**

Fits '62-later models equipped with Original Equipment or accessory Auxiliary Lamp Kits. Sold in pairs.

**3. 69749-05** Turn Signal – Flat Lens. **\$46.95**

Fits flat lens turn signals on front and rear of '14-later FLHR and FLHRC '88-'13 Touring (except FLHX, FLHRS, and '04-'13 FLTR), rear of '94-later FLSTC, '94-'97 FLSTN and '06 FLST models. Also fits FL Softail models with front Turn Signal Relocation Kit P/N 68413-99 or 68412-99.

**67700216** Headlamp. **\$44.95**

Fits '14-later Electra Glide®, Street Glide® and Tri Glide® models.

**69734-05** Headlamp. **\$43.95**

Fits '94-later FLS, FLST, FLSTC, FLSTF and FLSTN models. Also fits '15-later FLRT models.

**69735-05** Headlamp. **\$37.95**

Fits '94-'99 FXSTC, '94-later FXLR, FXST, FXSTB, '94-later Dyna® (except FXDF and FLD equipped with 7" headlamp) and '04-later XL883, XL883L, XL883N, XL1200L, XL1200N, XL1200X, XL883R and XL1200R and '05 VRSCB models. Also fits '08-later FLSTSB and FXS models.

**69738-05** Headlamp. **\$37.95**

Fits '07-later FXSTC, '96-later XL1200C, XL1200V, XL883C, '99 FXR, '93-later FXSTS, '95-'97 FXSTSB, '97-'03 FLSTS, '05-later FLSTSC and '00-'07 FXSTD models.

LIGHTING



**B. VISOR STYLE TRIM RING – ELECTRA GLIDE**



**B. VISOR STYLE TRIM RING – SOFTAIL DELUXE**



**B. VISOR STYLE TRIM RING – XL/DYNA**



**B. VISOR STYLE TRIM RING – XL CUSTOM**

### Model Family Fitment:

- V-ROD
- SPORTSTER
- DYNA
- SOFTAIL
- TOURING

*Notice: The prices appearing in this catalog are the manufacturer's suggested retail prices. Actual retail prices may vary.*

# 726 LIGHTING

## Headlamp Trim

### A. HEADLAMP TRIM RING – THE BURST COLLECTION

Sculpted machining sends reflections of light in all directions. This Headlamp Trim Ring features a rich black anodized finish that is machined to expose the highlights of raw aluminum. The contrasting cut-back look makes a powerful visual statement and works great with both traditional and contemporary customizing styles. Easy to install.

**61400149** **\$139.95**  
Fits '96-'13 Electra Glide®, Street Glide® and Trike models (except FLHTCUSE6/7/8 and FLHXSE2). Does not fit with Fairing Bra P/N 57800-00. Does not fit with accessory headlamps P/N 67700040A, 73390-10A or 90050-02A.

**Shown with:**

#### THE BURST COLLECTION TRIM RING – AUXILIARY LAMPS

Lamp Trim Rings feature a rich black anodized finish that is machined to expose the highlights of raw aluminum. Easy to install.

**61400255** Auxiliary Lamps. **\$199.95**  
Fits '62-later models equipped with Original Equipment or accessory Auxiliary Lamp Kits. Sold in pairs.



**A. HEADLAMP TRIM RING – THE BURST COLLECTION**

### B. HEADLAMP TRIM RING – GLOSS BLACK

Finish the Dark Custom™ look by replacing the Original Equipment chrome headlamp trim ring with sinister black. Easy to install, the ring's rich black surface matches the stock headlamp shell finish for a unified look.

**46555-03B** 7" Headlamp. **\$34.95**  
Fits '94-'14 Touring models (except Road Glide®).

**67700115** 7" Headlamp. **\$34.95**  
Fits '08-later FLS, FLST, FLSTC, FLSTF, FLSTFB and FLSTN models. Also fits '15-later FLRT models.

**67700116** 5-3/4" Headlamp. **\$29.95**  
Fits '05-'11 VRSCD/X/A/XA, '04-later XL883L, XL883N, XL883R, XL1200R, XL1200N, XL1200X, '04-'11 XL883C, XL1200C, '93-later Dyna® (except FLD and FXDF) and '11-later FXS models.

**67700117** 4" Passing Lamp. **\$46.95**  
Fits '62-later models equipped with Original Equipment or accessory Auxiliary Lamp Kits. Sold in pairs.

### C. CONTOURED HEADLAMP TRIM RING

Add an integrated look to your headlamp. The Contoured Headlamp Trim Ring, introduced on the Screamin' Eagle® Road King® model, is designed to visually reduce the space between the headlamp bulb and the headlamp housing for a sleek, custom style. The bright chrome finish matches the headlamp housing for a factory original look.

**69604-03A** **\$35.95**  
Fits '83-later Touring (except Tour Glide™ and Road Glide) and '86-later FL Softail® models with Headlight Nacelle. Does not fit Trike models.



**B. HEADLAMP TRIM RING – GLOSS BLACK (ROAD KING SHOWN)**



**B. HEADLAMP TRIM RING – GLOSS BLACK (FAT BOY LO SHOWN)**



**B. HEADLAMP TRIM RING – GLOSS BLACK (IRON 883 SHOWN)**

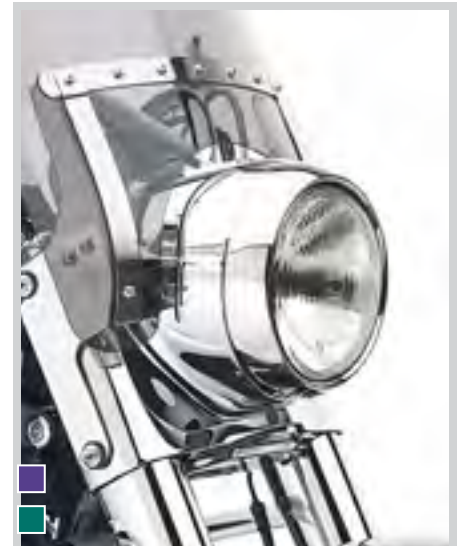

**C. CONTOURED HEADLAMP TRIM RING**

*Notice: The prices appearing in this catalog are the manufacturer's suggested retail prices. Actual retail prices may vary.*





**D. TRIM RING COLLECTION – GLOSS BLACK (ELECTRA GLIDE SHOWN)**



**D. TRIM RING COLLECTION – GLOSS BLACK (ROAD KING SHOWN)**



**E. VISOR STYLE TRIM RING COLLECTION – GLOSS BLACK (ELECTRA GLIDE SHOWN)**



**E. VISOR STYLE TRIM RING COLLECTION – GLOSS BLACK (ROAD KING SHOWN)**



**F. FREIGHT TRAIN HEADLIGHT NACELLE – CHROME**



**F. FREIGHT TRAIN HEADLIGHT NACELLE – GLOSS BLACK**

### D. TRIM RING COLLECTION – GLOSS BLACK

This easy to install Headlamp Trim Ring extends forward, giving the headlamp assembly a “frenched” look reminiscent of classic hot rod car designs by recessing the headlamp and adding the appearance of depth. Does not fit with accessory Headlamp Visors or Passing Lamp Visors.

**61400294** 7" Headlamp – Gloss Black. **\$44.95**  
Fits '14-later Electra Glide®, Street Glide® and Tri Glide® models.

**61400295** 7" Headlamp – Gloss Black. **\$44.95**  
Fits '83-'13 Touring (except Tour Glide™ and Road Glide®), '08-'13 Trike, '12-later FLD and '94-later Road King® models. Also fits '86-later FL Softail® models with Headlight Nacelle. Does not fit with Fairing Bra P/N 57800-00.

### E. VISOR STYLE TRIM RING COLLECTION – GLOSS BLACK

These easy to install Visor Style Trim Rings recess the headlamp into the housing and add a traditional “eyebrow” design to the headlamp shell. The trim ring stretches the profile of the bike for a long, lean appearance. Add matching Visor Style Passing Lamp and Turn Signal Trim Rings for a true custom look.

**61400292** 7" Headlamp – Gloss Black. **\$49.95**  
Fits '14-later Electra Glide, Street Glide and Tri Glide models.

**61400293** 7" Headlamp – Gloss Black. **\$49.95**  
Fits '83-'13 Touring (except Tour Glide and Road Glide), '08-'13 Trike, '12-later FLD and '94-later Road King models. Also fits '86-later FL Softail models with Headlight Nacelle. Does not fit with Fairing Bra P/N 57800-00.

### F. FREIGHT TRAIN HEADLIGHT NACELLE

If the shape of this nacelle seems to reflect the image of the 1960s FL models, that's because the spirit of the past is built right in. Bold locomotive styling adds visual strength to the bike's profile and stretches the rider's view to the horizon when looking over the headlamp. Coupled with the separate purchase of the Nacelle Hardware Kit P/N 67897-96B, the nacelle fits with an existing H-D® windshield and/or passing lamps. Kit includes hardware required for installation of the nacelle with a detachable windshield without passing lamps. Separate Hardware Kit is required when installing nacelle with passing lamps or rigid mount windshield.

Fits '86-later FLST, FLSTF, FLSTFB and FLSTC models. '07-later FLSTF and FLSTFB require separate purchase of Riser Kit P/N 56789-05. '09-later FLSTC requires separate purchase of Riser Kit P/N 46809-09.

**67907-96C** Chrome. **\$449.95**  
**61300138** Gloss Black. **\$449.95**

#### Model Family Fitment:

- V-ROD
- SPORTSTER
- DYNA
- SOFTAIL
- TOURING

*Notice: The prices appearing in this catalog are the manufacturer's suggested retail prices. Actual retail prices may vary.*

# 728 LIGHTING

## Headlamp Trim Rings

### A. SKULL COLLECTION LAMP VISORS

Add a little attitude to your ride. Styled to complement Harley-Davidson® Skull accessory items, the menacing raised skull with black-filled eyes leaps from a field of chrome. This complete collection of Lamp Visors dresses your bike for a true custom look.

**69793-07** Headlamp. **\$25.95**  
Fits 7" Headlamp. (Does not fit with Accessory Headlamp Trim Rings.)

**69794-07** Headlamp. **\$22.95**  
Fits 5-3/4" Headlamp. (Does not fit Springer™, XL883C, XL1200C, XL1200V or models with Accessory Headlamp Trim Rings.)

**69795-07** Passing Lamp. **\$28.95**  
Fits all Passing Lamps. ('87-later models require Passing Lamp Trim Rings P/N 68775-93TA.) (Does not fit models with Passing Lamp Trim Rings P/N 69622-99B or 69732-05.) Sold in pairs.

**69791-07** Flat Lens Turn Signal. **\$26.95**  
Fits front turn signals on '94-later FLHR, '07-later FLHRC, '86-'09 FLHT, '86-'13 FLHTC, '89-'13 FLHTCU, '10-'13 FLHTK and '88-later FLSTC models. Sold in pairs.

**69792-07** Flat Lens Turn Signal. **\$26.95**  
Fits rear turn signals on '94-later FLHR, '07-later FLHRC, '86-'09 FLHT, '86-'13 FLHTC, '89-'13 FLHTCU, '10-'13 FLHTK, '88-later FLSTC, '86-'90 FLST and '86-'92 FXRT models. Also fits front and rear turn signals on '88-'91 FLTC, '89-'96 FLTCU and '99-'03 FLTR models. Sold in pairs.

### B. CLASSIC CHROME LAMP VISORS

**67752-77T** Headlamp. **\$15.95**  
Fits 7" Headlamp. Use Installation Kit P/N 67761-96. (Does not fit with Accessory Headlamp Trim Rings.)

**67750-88T** Headlamp. **\$16.95**  
Fits 5-3/4" Headlamp including '05 VRSCB models. (Does not fit Springer, XL883C, XL1200C and XL1200V models or models with Accessory Headlamp Trim Rings.)

**67783-78T** Passing Lamp. **\$21.95**  
Fits all Passing Lamps. ('87-later models require Passing Lamp Trim Rings P/N 68775-93TA.) (Does not fit models with Passing Lamp Trim Rings P/N 69622-99B or 69732-05.) Sold in pairs.

**67734-88T** Turn Signal. **\$19.95**  
Fits front turn signals on '94-later FLHR, '07-later FLHRC, '86-'09 FLHT, '86-'13 FLHTC, '89-'13 FLHTCU, '10-'13 FLHTK and '88-later FLSTC models. Sold in pairs.

**67737-88T** Turn Signal. **\$19.95**  
Fits rear turn signals on '94-later FLHR, '07-later FLHRC, '86-'09 FLHT, '86-'13 FLHTC, '89-'13 FLHTCU, '10-'13 FLHTK, '88-later FLSTC, '86-'90 FLST and '86-'92 FXRT models. Also fits front and rear turn signals on '88-'91 FLTC, '89-'96 FLTCU and '99-'03 FLTR models. Sold in pairs.

**Also available:**

#### ROAD KING® HEADLAMP VISOR MOUNTING KIT

Allows 7" headlamp visors to be mounted on Road King® motorcycle.

**67761-96** **\$5.95**  
Fits '94-later FLHR. Visor and Trim Ring not included.

#### PASSING LAMP TRIM RINGS

Replaces Original Equipment P/N 68725-62. Required for proper installation of H-D® Passing Lamp Visors on '87-later models (except FXSTD).

**68775-93TA** **\$25.95**



A. SKULL COLLECTION LAMP VISORS



B. CLASSIC CHROME LAMP VISORS

*Notice: The prices appearing in this catalog are the manufacturer's suggested retail prices. Actual retail prices may vary.*



# LIGHTING 729

## Headlamp Trim Rings



C. EAGLE WING LOGO LAMP VISORS

### C. EAGLE WING LOGO LAMP VISORS

- |  |                           |                |
|--|---------------------------|----------------|
| <b>67791-91T</b>   | Headlamp.                 | <b>\$29.95</b> |
| Fits 7" Headlamp. (Does not fit with Accessory Headlamp Trim Rings.)   |                           |                |
| <b>67751-91T</b>   | Headlamp.                 | <b>\$29.95</b> |
| Fits 5-3/4" Headlamp. (Does not fit Springer™, XL883C, XL1200C and XL1200V models or models with Accessory Headlamp Trim Rings.)   |                           |                |
| <b>67796-91T</b>   | Passing Lamp. (not shown) | <b>\$32.95</b> |
| Fits all Passing Lamps. ('87-later models require Passing Lamp Trim Rings P/N 68775-93TA.) (Does not fit models with Passing Lamp Trim Rings P/N 69622-99B or 69732-05.) Sold in pairs.  |                           |                |
| <b>67913-95T</b>   | Sport Turn Signal.        | <b>\$36.95</b> |
| Fits '86-'01 XL, FXR, Softail® and '91-'01 Dyna® models (except '01 FXDX, FXDXT, FXSTD, FLST and FXRT models). Sold in pairs.  |                           |                |
| <b>67735-91T</b>   | Flat Lens Turn Signal.    | <b>\$31.95</b> |
| Fits front turn signals on '94-later FLHR, '07-later FLHRC, '86-'09 FLHT, '86-'13 FLHTC, '89-'13 FLHTCU, '10-'13 FLHTK and '88-later FLSTC models. Sold in pairs.  |                           |                |
| <b>67738-91T</b>   | Flat Lens Turn Signal.    | <b>\$31.95</b> |
| Fits rear turn signals on '94-later FLHR, '07-later FLHRC, '86-'09 FLHT, '86-'13 FLHTC, '89-'13 FLHTCU, '10-'13 FLHTK, '88-later FLSTC, '86-'90 FLST and '86-'92 FXRT models. Also fits front and rear turn signals on '88-'91 FLTC, '89-'96 FLTCU and '99-'03 FLTR models. Sold in pairs. |                           |                |



### D. TAIL LIGHT VISORS

Mirror-finish chrome visor dresses the tail light in style. Available in your choice of design, this easy to install visor adds a finishing touch.

Fits '73-later models (except VRSC™, XG, XR, XL883N, XL1200N, XL1200V, XL1200X, '11-later XL1200C, FXWG, FXDF, FXDWG, FX Softail, FLS, FLSTS, FLSTSB, FLSTN, FLHX and FLHTCUTG models). Does not fit '09-later FLHR, FLTR, FXDB or '14-later FLHXS, FLHRSE or FLHTKSE.

- |                  |                    |                |
|------------------|--------------------|----------------|
| <b>68006-83T</b> | Classic Chrome.    | <b>\$21.95</b> |
| <b>69790-07</b>  | Skull Collection.  | <b>\$27.95</b> |
| <b>68011-91T</b> | Eagle Wing Gold.   | <b>\$31.95</b> |
| <b>68011-88T</b> | Eagle Wing Chrome. | <b>\$23.95</b> |

Fits '06-'09 FLHX and '09-later FLHR, FLHRC, FLHT, '06-'09 FLTR and FLHTCUTG models with Original Equipment tail lamp. Also fits Touring models equipped with Bullet Turn Signal and License Plate Relocation Kit P/N 53702-04A.

- |                 |                   |                |
|-----------------|-------------------|----------------|
| <b>69787-07</b> | Skull Collection. | <b>\$27.95</b> |
|-----------------|-------------------|----------------|

### E. TAIL LIGHT COLLAR – CHROME

This chrome-plated ABS tail light collar dramatically changes the appearance of your rear fender. The collar is easy to install and the kit includes all mounting hardware.

- |   |  |                |
|---|--|----------------|
| <b>68311-01</b>   |  | <b>\$35.95</b> |
| Fits '73-later models (except VRSC, XG, XR, XL883N, XL1200N, XL1200V, XL1200X, '11-later XL1200C, FXWG, FXDF, FXDWG, FX Softail, FLS, FLSTS, FLSTSB, FLSTN, FLHX and FLHTCUTG models). Does not fit '09-later FLHR, FLTR, FXDB or '14-later FLHXS, FLHRSE or FLHTKSE. |  |                |

- |  |  |                |
|--|--|----------------|
| <b>68332-08</b>  |  | <b>\$35.95</b> |
| Fits '06-'09 FLHX and '09-later FLHR, FLHRC, FLHT, '06-'09 FLTR and FLHTCUTG models with Original Equipment tail lamp. Also fits Touring models equipped with Bullet Turn Signal and License Plate Relocation Kit P/N 53702-04A. |  |                |



D. CHROME TAIL LIGHT VISOR – CLASSIC CHROME



D. TAIL LIGHT VISOR – SKULL COLLECTION



D. LOGO TAIL LIGHT VISOR – EAGLE WING



E. TAIL LIGHT COLLAR – CHROME

#### Model Family Fitment:

- |         |           |      |
|---------|-----------|------|
| V-ROD   | SPORTSTER | DYNA |
| SOFTAIL | TOURING   |      |

Notice: The prices appearing in this catalog are the manufacturer's suggested retail prices. Actual retail prices may vary.

# 730 LIGHTING

## Headlamp Trim

### A. TURN SIGNAL TRIM RINGS

Trim ring contour matches the turn signal housing and extends out past the lens for a sleek appearance. These easy-to-install chrome-plated trim rings look great alone or in combination with Headlamp Trim Rings. Available in Visor Style for a nostalgic look or in Trim Ring style for contemporary "frenched" contour. Sold in pairs.

#### Bullet Front or Rear, Amber Lenses

Fits models equipped with rear bullet style turn signals (except VRSC™, XL883N, XL1200N, XL1200V, XL1200X, FXCW, FXCWC, FXDB, FXS, FXSB, FXSBSE, FLS, FLSTC, International models with rear LED turn signals and models equipped with Auxiliary Turn Signal Brake Light Kit P/N 69465-06, 69463-06 or 69462-06B).

<b>69756-05</b>	Visor Ring Style.	<b>\$33.95</b>
<b>69739-01</b>	Trim Ring Style.	<b>\$33.95</b>

#### Bullet Front, Lenses with Amber Bulbs

Fits models equipped with front bullet style turn signals (except VRSC, XL883N, XL1200X, FLSTC, FLHP, FLHR, FLHRC and models equipped with Original Equipment or accessory LED Turn Signals).

<b>69758-05</b>	Smoked, Visor Ring Style.	<b>\$36.95</b>
<b>69752-04</b>	Smoked, Trim Ring Style.	<b>\$36.95</b>
<b>69760-05</b>	Clear, Visor Ring Style.	<b>\$36.95</b>
<b>69754-04</b>	Clear, Trim Ring Style.	<b>\$36.95</b>

#### Bullet Rear, Lenses with Amber Bulbs

Fits models equipped with rear bullet style turn signals (except VRSC, XL883N, XL1200N, XL1200V, XL1200X, FXCW, FXCWC, FXS, FXSB, FXSBSE, FXST-Aus, '09-later FXDB, FXDWG, FLS, FLSTC, models with Original Equipment or accessory LED turn signals and models equipped with Auxiliary Turn Signal Brake Light Kit P/N 69465-06, 69463-06 or 69462-06B).

<b>69759-05</b>	Visor Ring Style.	<b>\$36.95</b>
<b>69753-04</b>	Trim Ring Style.	<b>\$36.95</b>
<b>69761-05</b>	Clear, Visor Ring Style.	<b>\$36.95</b>
<b>69755-04</b>	Clear, Trim Ring Style.	<b>\$36.95</b>

#### Bullet Rear, Red Lenses

Fits rear of models equipped with bullet style turn signals (except VRSC, FXDB, FLSTC, FXSB, FXSBSE, FXST-Aus and International models with LED turn signals) and Auxiliary Brake Light Kit P/N 69465-06 or 69462-06B.

<b>69757-05</b>	Visor Ring Style.	<b>\$33.95</b>
<b>69736-02</b>	Trim Ring Style.	<b>\$33.95</b>

### B. BULLET TURN SIGNAL VISOR TRIM RING – BLACK

Visor-shaped trim rings add a traditional look to the contemporary style of the bullet turn signal. These easy-to-install black finish trim rings are available with smoked or red lenses to match your customizing direction. Sold in pairs.

<b>73342-09</b>	Front, Smoked Lens, Amber Bulb.	<b>\$36.95</b>
-----------------	---------------------------------	----------------

Fits '11-'13 XL1200C, and '08-later XL883N, XL1200N, XL1200X, FLS and FLSTSB models (except FLSTC and models equipped with Original Equipment or accessory LED signal lamps).

<b>73343-09</b>	Rear, Smoked Lens, Amber Bulb.	<b>\$36.95</b>
-----------------	--------------------------------	----------------

Fits '09-later FLSTSB models (except models equipped with Original Equipment or accessory LED turn signals).

<b>73344-09</b>	Rear, Red Lens.	<b>\$33.95</b>
-----------------	-----------------	----------------

Fits '11-later XL1200C, '08-later XL883N, and XL1200N and '08-'13 XL1200V and XL1200X models except models equipped with Original Equipment or accessory LED signal lamps. Also fits FLS and FLSTSB models equipped with Auxiliary Turn Signal and Brake Light Kit P/N 69462-06B.



A. TURN SIGNAL VISOR TRIM RINGS – BULLET STYLE



A. TURN SIGNAL TRIM RINGS – BULLET STYLE



B. BULLET TURN SIGNAL VISOR TRIM RINGS – BLACK

Notice: The prices appearing in this catalog are the manufacturer's suggested retail prices. Actual retail prices may vary.





NEW

C. AUXILIARY POWER SWITCH KIT – FAIRING MOUNT (71400106 SHOWN)



NEW

**C. AUXILIARY POWER SWITCH KIT – FAIRING MOUNT**

Styled to match the Original Equipment fairing dash panel switches. These Auxiliary Power switches allow you to control additional fog lamps, auxiliary lighting, heated gear or electrical accessories with the touch of a finger. Kit includes two auxiliary switches, wire harnesses and installation hardware.

**71400106** **\$79.95**  
Fits '14-later Electra Glide® and Tri Glide® models.

**71400105** **\$119.95**  
Fits '14-later Road Glide® and Street Glide® models. Includes dash switch assembly mount.

**D. FAIRING POWER EXTENSION HARNESS**

Harness permits the addition of multiple accessories to the front fairing power connector, including Boom!™ Audio Hidden AM/FM/WB Antenna, Electra Glo™ Light Rings or Electra Glo Fairing Edge Lights.

**69200921** **\$9.95**  
Fits '14-later Electra Glide, Road Glide, Street Glide and Tri Glide models.



NEW

C. AUXILIARY POWER SWITCH KIT – FAIRING MOUNT (71400105 SHOWN)



NEW

D. FAIRING POWER EXTENSION HARNESS

**E. ELECTRICAL CONNECTION UPDATE KIT – TOURING\***

Harness plugs into accessory connector to provide 12-volt power leads. Required to install Heated Grips, XM Radio, Cruiser Amp & Speaker Systems, zümo® GPS, Digital Oil Pressure Gauge, Garage Door Opener Kits, Heated Seats and decorative lighting on '14-later Touring and Trike models.

**69200722** **\$23.95**  
Fits '14-later Touring and Trike models.

**F. ELECTRICAL CONNECTION UPDATE KIT\***

Mini 'Y' harness plugs into data port to provide 12-volt power leads and replacement data port socket. This kit is required to easily complete the installation of accessories requiring electrical power connection. For use with accessories like Road Tech™ zümo GPS Navigators, Boom!™ Audio Cruiser Amp and Speakers, Mini-Tachs, Digital Oil Pressure Gauges and Heated Grips.

**72673-11** **\$17.95**  
Fits '14-later XL, '12-later Dyna® and '11-later Softail® models.

**G. SWITCHED CIRCUIT ADAPTER HARNESS\***

This harness allows two accessories to be connected to the switched accessory circuit featured on '94-later Touring models. You then may switch two accessories on or off simultaneously as required.

**70264-94A** **\$19.95**  
Fits '94-later Touring and Trike models. Required on '14-later Touring and Trike models when connecting multiple powered accessories using Electrical Connection Kit P/N 69200722.

**H. ELECTRICAL ACCESSORY ADAPTER\***

Harness accommodates the addition of multiple electrical accessories to the main battery power circuit on specified models.

**70270-04** **\$15.95**  
Fits '04-'13 XL, XR, Touring and Trike models. Also fits '07-later VRSC™, '04-'11 Dyna and '04-'10 Softail models.



E. ELECTRICAL CONNECTION UPDATE KIT – TOURING



F. ELECTRICAL CONNECTION UPDATE KIT



G. SWITCHED CIRCUIT ADAPTER HARNESS



H. ELECTRICAL ACCESSORY ADAPTER

\*NOTE: It is possible to overload your motorcycle's charging system by adding too many electrical accessories. If your combined electrical accessories operating at any one time consume more electrical current than your vehicle's charging system can produce, the electrical consumption can discharge the battery and cause vehicle electrical system damage. Ask your dealer for advice about the amount of current consumed by additional electrical accessories.

**Model Family Fitment:**

- V-ROD
- SPORTSTER
- DYNA
- SOFTAIL
- TOURING

Notice: The prices appearing in this catalog are the manufacturer's suggested retail prices. Actual retail prices may vary.

# 732 LIGHTING

## Horns

### A. LOUD SIDE-MOUNT HORN KIT

Get Noticed. Ride with increased confidence with a loud horn that will grab everyone's attention. Engineered to be 5dB louder (at 2 meters) than the '13-earlier Original Equipment side-mounted horn. The loud horn is stock on '14-later models equipped with side-mount horns. Designed to be a plug-in replacement that is easy to install. Fits all H-D® side-mount horn covers.

**69060-90H** **\$44.95**

Fits '91-later VRSC™, XL1200C, XL1200V, Dyna® (except '14-later FXDL), Softail® (except FLSTS, FLSTSC, FXCW, FXCWC, FXS, FXSB and FXSBSE), Touring and Trike models. Stock on '14-later models equipped with a side-mount horn.



**NEW**



**NEW**



**A. LOUD SIDE-MOUNT HORN KIT**

### B. LOUD HORN KIT

Grab everyone's attention. Engineered to be 3dB louder (at 2 meters) than the Original Equipment front-mounted horn, this Horn Kit is tuned to a frequency that helps cut through the background noise. Designed to be a plug-in replacement for the factory horn, this easy-to-install option is available in your choice of brilliant chrome or gloss black finish. The traditional Bar & Shield logo adds a classic finishing touch.

Fits '96-later XL and XR models with front-mount horn.

**69000007** Chrome. **\$29.95**

**69000009** Gloss Black. **\$29.95**

### C. SIDE-MOUNT HORN KIT – CHROME

Convert your stock Sportster® horn to the look of a Big Twin.

**69112-95E** **\$94.95**

Fits '92-later XL883, XL883H, XL883C, XL883L, XL883N, XL883R, XL1200, XL1200L, XL1200N, XL1200R, XL1200V, XL1200X and '08-'13 XR models.



**B. LOUD HORN KIT – CHROME**



**B. LOUD HORN KIT – GLOSS BLACK**



**C. SIDE-MOUNT HORN KIT – CHROME**



*Notice: The prices appearing in this catalog are the manufacturer's suggested retail prices. Actual retail prices may vary.*



# LIGHTING 733

Horns



**D. HORN COVER KIT – GLOSS BLACK**

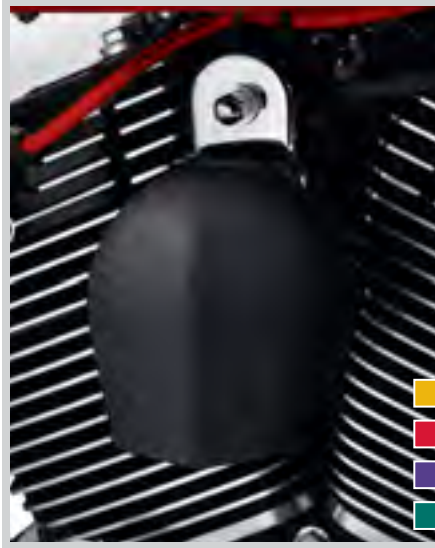

**E. WRINKLE BLACK HORN COVER**



**F. SMOOTH HORN COVER**



**G. AIR WING HORN COVER**



**H. BAR & SHIELD LOGO HORN COVER**



**I. CLASSIC HORN**

**D. HORN COVER KIT – GLOSS BLACK**

This Horn Cover Kit is the perfect start in converting your powertrain to a striking “blacked-out” look. Manufactured from Original Equipment components, this cover is painted alongside our other components to ensure a matching black finish. Kit includes gloss black mounting bracket and hardware.

**61300452** **\$41.95**  
Fits '93-later models with side-mounted horn (except VRSC™ and XG models).

**E. WRINKLE BLACK HORN COVER**

This powder coated horn cover is the perfect start in converting your powertrain to a striking “blacked-out” look. Manufactured from Original Equipment components, this cover is painted on the factory production line to ensure a matching wrinkle black finish.

**69039-09A** **\$38.95**  
Fits '93-later models with side-mounted horn (except VRSC and XG models).

**F. SMOOTH HORN COVER**

Add a custom touch to your ride. Styled to complement the Smooth Air Cleaner Cover P/N 29153-07, this compact round horn cover features a mirror-chrome finish. Mounts easily to the stock horn cover bracket.

**68189-07** **\$38.95**  
Fits '93-later models with side-mounted horn (except VRSC and XG models).

**G. AIR WING HORN COVER**

This exclusive Air Wing chrome-plated horn cover is styled to complement the Harley-Davidson® Billet Air Cleaner Cover and is a stylish replacement for the Original Equipment horn cover. Mounts easily to stock horn cover bracket.

**69167-02A** **\$47.95**  
Fits '93-later models with side-mounted horn (except VRSC and XG models).

**H. BAR & SHIELD LOGO HORN COVER**

Complement your engine fins with this chrome-plated horn cover with engraved inserts, which feature a Bar & Shield emblem accented by a black background. Easily mounts to stock horn bracket.

**69166-01A** **\$47.95**  
Fits '93-later models with side-mounted horn (except VRSC and XG models).

**I. CLASSIC HORN**

Early style 12V horn features nostalgic Harley-Davidson Bar & Shield logo on chrome cover. To be used as an auxiliary horn only. Do not disconnect your Original Equipment horn.

**69036-88A** Classic Horn Kit. **\$79.95**  
Fits '88-'06 FXSTS models (does not fit FLSTS or FLSTSC). Includes chrome mounting bracket and acorn nuts.

**Model Family Fitment:**

- V-ROD
- SPORTSTER
- DYNA
- SOFTAIL
- TOURING

*Notice: The prices appearing in this catalog are the manufacturer's suggested retail prices. Actual retail prices may vary.*

LIGHTING

# 734 LIGHTING

## License Plate Frames & Mounts

### A. CURVED LICENSE PLATE FRAME – TOURING

Love the look of your bike but hate the appearance of your state-mandated license plate? This stylish Curved License Plate Frame is shaped to hug the contour of the rear fender. Designed to replace the Original Equipment black license plate bracket, installation requires no drilling or rewiring. The front frame cover conceals the plate's mounting holes and raw edges and the curved shape hides the unfinished rear side of the plate. Available in chrome or gloss black finish, the complete kit includes all required mounting hardware.

Fits '10-later FLHX, FLHXS, FLHXSE, FLTRX and FLTRXS models.

<b>67900008</b>	Chrome.	<b>\$89.95</b>
<b>67900058</b>	Gloss Black.	<b>\$89.95</b>

Fits '06-'09 FLHX and '09 FLTR, FLHR and FLHT models.

<b>67900056</b>	Chrome.	<b>\$89.95</b>
<b>67900059</b>	Gloss Black.	<b>\$89.95</b>



**A. CURVED LICENSE PLATE FRAME – TOURING, CHROME**



**A. CURVED LICENSE PLATE FRAME – TOURING, GLOSS BLACK**

### B. CURVED LICENSE PLATE FRAME – SOFTAIL® DELUXE

Love the look of your bike but hate the appearance of your state-mandated license plate? This stylish Curved License Plate Frame is shaped to hug the contour of the rear fender and layback design reduces the "in-your-face" look of the flat, unfinished plate. Designed to replace the upright license plate mount, the front frame cover hides the plate's holes and raw edges and the solid backing plate conceals the unfinished rear side of the plate. Available in chrome or gloss black finish, the complete kit includes all required mounting hardware.

Fits '05-later FLSTN and '05-'07 FLSTSC models.

<b>67900007</b>	Chrome.	<b>\$89.95</b>
<b>67900057</b>	Gloss Black.	<b>\$89.95</b>



**B. CURVED LICENSE PLATE FRAME – SOFTAIL DELUXE, CHROME**



**B. CURVED LICENSE PLATE FRAME – SOFTAIL DELUXE, GLOSS BLACK**

### C. FRAMED LAYBACK LICENSE PLATE MOUNT

Wrap your license plate in chrome. This mirror-finish license mount tips the plate back for a sleek appearance and conceals the mounting hardware for a custom look. The front frame covers the license holes and the mirror-smooth back plate hides the unfinished rear of the plate. Kit accepts plates measuring to 7.25" x 4.25" (184 x 108mm). Kit includes installation hardware and rear fender reflector.

**60193-07** Fender Top. **\$69.95**

Fits license plate up to 7.25" x 4.25". Fits models with a three-hole rear fender mount license plate bracket. (Does not fit VRSC, XL883N, XL1200N, XL1200T, XL1200V, XL1200X or '11-later XL1200C models, FXDS-CONV, FXDXT, '00-'01 FXDX, '09-later FLD, FXDB and '10-later FXDWG models, FXCW, FXCWC, FXS, FXSB, FXSBSE, FLS or FLSTS models, Touring models, Trike models or models with a Bobtail Rear Fender.) (Check for clearance before installing with rear fender rack.)

**60210-07** Touring. **\$69.95**

Fits '99-'08 Road King®, Road Glide® and Electra Glide® Standard models with 7.25" x 4.25" license plate.



**C. FRAMED LAYBACK LICENSE PLATE MOUNT – FENDER TOP**



**C. FRAMED LAYBACK LICENSE PLATE MOUNT – TOURING**

*Notice: The prices appearing in this catalog are the manufacturer's suggested retail prices. Actual retail prices may vary.*



# LIGHTING 735

## License Plate Frames & Mounts



**D. LAYBACK LICENSE PLATE MOUNT – FENDER TOP**



**D. LAYBACK LICENSE PLATE MOUNT – TOURING**



**E. LAYBACK LICENSE PLATE AND TURN SIGNAL RELOCATION KIT**



**F. BOBTAIL FENDER LICENSE PLATE MOUNT – CHROME**



**G. DIAMOND ICE LICENSE PLATE FRAME – BOTTOM LOGO**



**G. DIAMOND ICE LICENSE PLATE FRAME – TOP LOGO**

### D. LAYBACK LICENSE PLATE MOUNT

Showcase your laid-back attitude by replacing the stand-up license plate mount. Chrome-plated die-cast mount tips the license plate back for a low-profile style. Kit accepts plates measuring to 7.25" x 4.25" (184 x 108mm). Kit includes chrome-plated license mounting hardware, installation hardware and rear fender reflector.

**60280-07** Fender Top. **\$49.95**

Fits license plate up to 7.25" x 4.25". Fits models with a three-hole rear fender mount license plate bracket. (Does not fit VRSC™, XL883N, XL1200N, XL1200T, XL1200V, XL1200X or '11-later XL1200C models, FXDS-CONV, FXDXT, '00-'01 FXDX, '09-later FLD, FXDB, '10-later FXDWG models, FXCW, FXCWC, FXS, FXSB, FXSBSE, FLS or FLSTS models, Touring models, Trike models or models with a Bobtail Rear Fender.) (Check for clearance before installing with rear fender rack.)

**60277-07** Touring. **\$41.95**

Fits '99-'08 Road King®, Road Glide® and Electra Glide® Standard models with 7.25" x 4.25" license plate.

### E. LAYBACK LICENSE PLATE AND TURN SIGNAL RELOCATION KIT

This kit combines our popular Layback License Plate Mount with an integrated turn signal bar to add a stylish slant to the rear fender. Kit relocates the Original Equipment bullet-style turn signals from the fender strut to the turn signal bar to allow clearance for saddlebags. This kit is a stylish alternative to Turn Signal Relocation Kit P/N 68732-02A and includes all necessary mounting hardware.

**60215-06** **\$89.95**

Fits '04-later XL (except XL883N, XL1200C, XL1200N, XL1200T, XL1200V and XL1200X) and '02-later Dyna® models (except FLD, FXDF, FXDWG and '09-later FXDB). Does not fit models equipped with side-mount license plates.

### F. BOBTAIL FENDER LICENSE PLATE MOUNT – CHROME

Show off your tail. This chrome-plated cover fits over the stock fender mount license plate bracket. This mirror-finished cover features a custom reflector with "Harley-Davidson" graphics. Includes mounting hardware for cover and license plate.

**59720-01A** **\$39.95**

Fits '99-'08 FXDWG, '00-later FXSTD, FXST, FXSTB, FXSTC, FLSTSB, FXSTS and XL and Dyna models equipped with H-D® Bobtail Fender Kits.

### G. DIAMOND ICE LICENSE PLATE FRAMES

Radius-cornered License Plate Frame features a single row of rhinestones emanating from a central raised Bar & Shield logo. Frame is available with top- or bottom-mounted medallion to maximize visibility in specific applications.

Fits 7.25" x 4.25" license plates (except XR, FLHTCUTG and models equipped with Layback License Plate Mounting Kits or side-mount license plates).

**60969-10** Top Logo. **\$45.95**

**60949-10** Bottom Logo. **\$45.95**

#### Model Family Fitment:

- V-ROD
- SPORTSTER
- DYNA
- SOFTAIL
- TOURING

*Notice: The prices appearing in this catalog are the manufacturer's suggested retail prices. Actual retail prices may vary.*

# 736 LIGHTING

## License Plate Frames & Mounts

### A. HARLEY-DAVIDSON® LICENSE PLATE FRAME

Make your plate shine with this chrome-plated license plate frame, featuring a black paint-filled "Harley-Davidson" logo. Includes chrome-plated stainless steel mounting hardware.

**60051-01 \$23.95**

Fits 7.25" x 4.25" license plates (except XR, Trike and models equipped with Layback License Plate Mounting Kits or side-mount license plates).

**60050-01 \$23.95**

Fits 8.25" x 4.75" license plates (except XR, Trike and models equipped with Layback License Plate Mounting Kits or side-mount license plates).

### B. "HARLEY-DAVIDSON" SCRIPT LICENSE PLATE FRAME

If a license plate is required, you might as well make it look good. This decorative, chrome-plated license plate frame has three-dimensional twist contours, a black "Harley-Davidson" script and a DOT compliant reflector. Stainless steel mounting hardware included.

**59141-98 \$26.95**

Fits 7.25" x 4.25" license plates (except XR, Trike and models equipped with Layback License Plate Mounting Kits or side-mount license plates).

### C. USA LICENSE PLATE FRAME

Ride with pride. This chrome-plated license plate frame combines Bar & Shield logos with multi-color red, white and blue "USA" lettering. Includes chrome-plated stainless steel mounting hardware.

**60065-03 \$23.95**

Fits 7.25" x 4.25" license plates (except XR, Trike and models equipped with Layback License Plate Mounting Kits or side-mount license plates).

### D. LICENSE PLATE FRAME – CHROME

**59863-94T \$16.95**

Fits 7.25" x 4.25" license plates (except XR, XL883N, XL1200N, XL1200X, FXCW, FXCWC, '10 FXDWG, FXSB, FXDF and Trike models).

### E. BILLET LICENSE PLATE FRAME

Make a custom statement. Manufactured from billet aluminum, this mirror-polished license plate frame features hidden hardware and bright chrome backing plate for a clean look. The kit includes "Harley-Davidson", "Sportster", "Fat Boy" and "Road King" logo engraved inserts for the ultimate finishing touch. Chrome-plated stainless steel mounting hardware included.

**60060-04 \$79.95**

Fits 7.25" x 4.25" license plates (except XR and Trike models equipped with Layback License Plate Mounting Kits and Side-Mount License Plates).

### F. LICENSE PLATE BRACKET – CHROME

**59983-75T \$24.95**

Fits '75-later XL models (except XL883N, XL1200N, XL1200T, XL1200V, XL1200X and '11-later XL1200C), '76-'84 FL models and '71-later FX, FXR (except FXSB, FXSBSE, FXST and FXWG).



A. HARLEY-DAVIDSON LICENSE PLATE FRAME



B. "HARLEY-DAVIDSON" SCRIPT LICENSE PLATE FRAME



C. USA LICENSE PLATE FRAME



D. LICENSE PLATE FRAME – CHROME



E. BILLET LICENSE PLATE FRAME



F. LICENSE PLATE BRACKET – CHROME

#### Model Family Fitment:

- V-ROD
- SPORTSTER
- DYNA
- SOFTAIL
- TOURING

*Notice: The prices appearing in this catalog are the manufacturer's suggested retail prices. Actual retail prices may vary.*





**G. LOUVERED LICENSE BACKING PLATE**

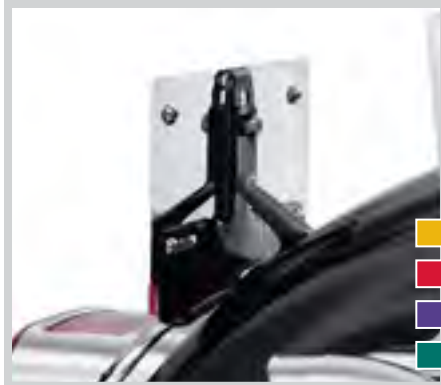

**H. SMOOTH LICENSE BACKING PLATE**

**G. LOUVERED LICENSE BACKING PLATE**

**59899-88T** **\$21.95**  
 Fits license plates with a 5.75" x 2.75" center-to-center hole mounting pattern (except XG, XR, XL883N, XL1200N, XL1200X, '10 FXDWG, FXCW, FXCWC, FXSB, FXSBSE, FLSTNSE and Trike models).

**H. SMOOTH LICENSE BACKING PLATE**

Cover the back of your license plate for the complete custom transformation. This polished stainless steel License Backing Plate looks great with or without a frame. Kit includes chrome-plated stainless steel mounting hardware.

**60041-04** **\$25.95**  
 Fits 7.25" x 4.25" license plates (except XR, Trike and models equipped with Layback License Plate Mounting Kits or side-mount license plates).



**I. SKULL LICENSE PLATE MOUNTING HARDWARE**



**J. BAR & SHIELD LOGO LICENSE PLATE MOUNTING HARDWARE KIT**

**I. SKULL LICENSE PLATE MOUNTING HARDWARE**

Leave them looking at your "attitude." This complete license plate hardware kit features chrome-plated skull-shaped bolts with sinister black-filled eyes. The hardware is installed with a special open wrench to reduce the possibility of license plate theft. Kit includes 4 skull bolts, nuts, lock washers and the special wrench.

**94546-05** Universal (except FLHTCUTG). **\$27.95**

**J. BAR & SHIELD LOGO LICENSE PLATE MOUNTING HARDWARE KIT**

Proudly display the Bar & Shield. The Bar & Shield logo shaped bolt heads on this unique chrome-plated stainless steel License Plate Mounting Kit stand out from the pack. The hardware is installed with a custom Bar & Shield logo shaped wrench, reducing the possibility of license plate theft. The kit includes 4 lock nuts, washers, bolts and the special wrench.

**94114-02** Universal (except FLHTCUTG). **\$21.95**

**K. WILLIE G SKULL COLLECTION LICENSE PLATE HARDWARE KIT**

Your bike has an attitude front to back and the final view they see should reflect it. This chrome-plated hardware kit features a skull logo set off by a black background. Sold in sets of 4, includes .25"-20 x .75" fasteners with lock nuts and washers.

**41170-03** Universal (except FLHTCUTG). **\$21.95**

**L. BAR & SHIELD LOGO LICENSE PLATE HARDWARE KIT**

This chrome-plated hardware kit features the Bar & Shield logo set against a gloss black background. Kit includes a set of four .25"-20 x .75" fasteners with matching lock nuts and washers.

**41161-01** Universal (except FLHTCUTG). **\$21.95**

**M. LICENSE PLATE MOUNTING KIT WITH BUTTON HEAD SCREWS**

Kit contains two chrome button head screws, two chrome acorn nuts, two chrome flat washers and two chrome lock washers.

**94109-95** Universal fitment. **\$6.95**

**N. LICENSE PLATE MOUNTING KIT**

Kit contains two chrome .25" acorn nuts, two chrome .25"-20 screws and two chrome .25" lockwashers.

**94135-93T** Universal fitment. **\$5.95**



**K. WILLIE G SKULL COLLECTION LICENSE PLATE HARDWARE KIT**



**L. BAR & SHIELD LOGO LICENSE PLATE HARDWARE KIT**



**M. LICENSE PLATE MOUNTING KIT WITH BUTTON HEAD SCREWS**



**N. LICENSE PLATE MOUNTING KIT**

LIGHTING

*Notice: The prices appearing in this catalog are the manufacturer's suggested retail prices. Actual retail prices may vary.*



GENUINE MOTOR PARTS & ACCESSORIES



2015

## WHEELS

Nothing changes the overall look of your Harley® motorcycle quite the way a set of custom wheels can. From classic laced to contemporary forged models, you'll be rolling down the road with a whole new level of pride in your ride.



### STRENGTH AND STYLE

From a visual perspective, the wheels, sprocket and brake rotors make up almost half of the motorcycle's profile and set the styling direction for the whole bike. Choose wisely. Harley-Davidson® forged, cast and laced wheels undergo thousands of hours of real-world testing to meet the highest standards of performance and durability.



SEEING THE DIFFERENCE



MIRROR CHROME

Looking for the ultimate flash? Choose Mirror Chrome wheels. To achieve this rich look, our dedicated team of polishers spends hours preparing the wheel for its finish. All visible wheel surfaces are micro-polished to a glass smooth finish and special masking is applied to prevent contamination to threads and bearing bores.



CONTRAST CHROME

Can't make up your mind? Choose Contrast Chrome wheels. We start with a hand polished wheel and add a proprietary finish that features both gloss black paint and chrome highlights. The combination produces a stunning contrast that lightens the wheel's profile by visually thinning the spokes, rim and hub.



BLACK ICE

Want the blacked-out look but unwilling to give up the shine? Choose Black Ice wheels. First, we polish all the surfaces. Then we apply the exclusive Black Ice coating for a finish with incredible depth and shimmer—impossible to achieve with ordinary "black chrome." These wheels look perfect on a blacked-out bike, but the wet-look holds its own in the company of chrome.



CUT BACK

Looking for a cool, hard-edged style? Choose Cut Back wheels. We start with a raw wheel, polish all the exposed surfaces and coat the wheel in a durable easy-to-clean gloss black finish. But we don't stop there. We machine an intricate pattern into the wheel to the raw aluminum surface below. The resulting exposure of machined edges add a tough look to your ride's profile.

ORDERING PROCESS

**Step 1:** Select a wheel part number for your specific fitment.

**Step 2:** Select the wheel installation kit for your specific application (model, year and front or rear). Note: If your model is not specified in the wheel fitment, a wheel installation kit will not make the wheel fit your model.

**Step 3:** Refer to the instruction sheet included in your wheel kit to determine the necessary parts required from the installation kit.

**Step 4:** Use only Harley-Davidson® specified tires. See a Harley-Davidson dealer. Using non-specified tires can adversely affect stability, handling or braking, which could result in death or serious injury.



WHEEL INSTALLATION KITS

Once you select your wheel style, select the Wheel Installation Kit designed specifically for your motorcycle. Kit includes the bearings and spacers required for installation.

WHEEL INSTALLATION KITS

<b>43833-07A</b>	Front, .75" axle.	<b>\$89.95</b>
Fits '00-'07 XL, '00-'03 Dyna®, '00-'05 FXDWG, '00-'06 Softail® (except FLSTS, FLSTSC and FXSTDSE) and '08-later FLSTSB models.		
<b>43848-08A</b>	Front, 1.0" axle.	<b>\$89.95</b>
Fits '02-'07 VRSC™, '04-'07 Dyna (except '04-'05 FXDWG) and '00-'07 Touring models.		
<b>43851-11A</b>	Front, 25mm axle.	<b>\$79.95</b>
Fits '07-later VRSC without ABS brakes (except FLSTSB, FLSTSC, FXCW, FXCWC and FXSB) and '08-later FLD, FXDF and FXDWG models without ABS brakes.		
<b>41454-08B</b>	Front, 25mm axle, ABS.	<b>\$79.95</b>
Fits '08-later VRSC with ABS brakes, '12-later FXDB, FXDC and FXDL with ABS brakes and '08-later Touring models with ABS brakes.		
<b>41455-08C</b>	Front, 25mm axle.	<b>\$79.95</b>
Fits '08-later VRSC without ABS brakes, '08-later Dyna without ABS brakes (except FLD, FXDWG and FXDF) and '08-later Touring and Trike models without ABS brakes. Also fits '09-'11 Sidecar.		

<b>42400008</b>	Front, 25mm axle.	<b>\$79.95</b>
Fits '15-later XG, '08-later XL without ABS brakes and '13-later FXSB models without ABS brakes.		
<b>42400009A</b>	Front, 25mm axle, ABS.	<b>\$79.95</b>
Fits '14-later XL with ABS brakes and FXSB and FXSBSE models with ABS brakes.		
<b>42400010</b>	Front, 25mm axle, ABS.	<b>\$79.95</b>
Fits '11-later Softail models with ABS brakes (except FLSTSB, FXCW, FXCWC, FXSB and FXSBSE) and '12-later FLD, FXDF and FXDWG with ABS brakes.		
<b>43854-08A</b>	Rear, .75" axle.	<b>\$89.95</b>
Fits '00-'04 XL, '00-'05 Dyna, '00-'07 Softail and '00-'01 Touring models.		
<b>43861-08A</b>	Rear, 1.0" axle.	<b>\$89.95</b>
Fits '02-'07 VRSC, '05-'07 XL, '06-'07 Dyna and '02-'07 Touring models.		
<b>43878-08B</b>	Rear, 25mm axle.	<b>\$79.95</b>
Fits '08-later XL without ABS brakes, '08-later Softail without ABS brakes (except FXCW, FXCWC and FXSB) and '08 Touring models without ABS brakes.		

<b>41451-08C</b>	Rear, 25mm axle.	<b>\$79.95</b>
Fits '15-later XG and '08-later Dyna models without ABS brakes.		
<b>41456-08C</b>	Rear, 25mm axle.	<b>\$79.95</b>
Fits '08-'13 VRSC without ABS brakes, '08-'13 FXCW, FXCWC and FXSB without ABS brakes and '09-later Touring models without ABS brakes.		
<b>41453-08C</b>	Rear, 25mm axle, ABS.	<b>\$79.95</b>
Fits '08-later VRSC with ABS brakes, '14-later XL with ABS brakes and '08-later Touring models with ABS brakes.		
<b>43077-11</b>	Rear, 25mm axle, ABS.	<b>\$79.95</b>
Fits '11-later Softail models with ABS brakes.		
<b>42400003</b>	Rear, 25mm axle, ABS.	<b>\$79.95</b>
Fits '12-later Dyna models with ABS brakes.		

Notice: The prices appearing in this catalog are the manufacturer's suggested retail prices. Actual retail prices may vary.



# 742 WHEELS

Machete – Mirror Chrome

## MACHETE CUSTOM WHEELS – MIRROR CHROME

Tempered like a fine blade, the Machete wheel holds an edge like no other. This stunning mirror-chrome motion-style wheel features 3-dimensional cutting edge spokes that catch the light and shine like the full moon on a cloudless night. Tested to H-D's high standards for durability and finish, this wheel will give trouble-free miles year after year, and will keep attracting the crowd's attention.

Requires separate purchase of model-specific Wheel Installation Kit, Sprocket hardware and Brake Rotor-specific hardware. See I-sheet for details. Installation may require separate purchase of wheel size and model-specific tire.

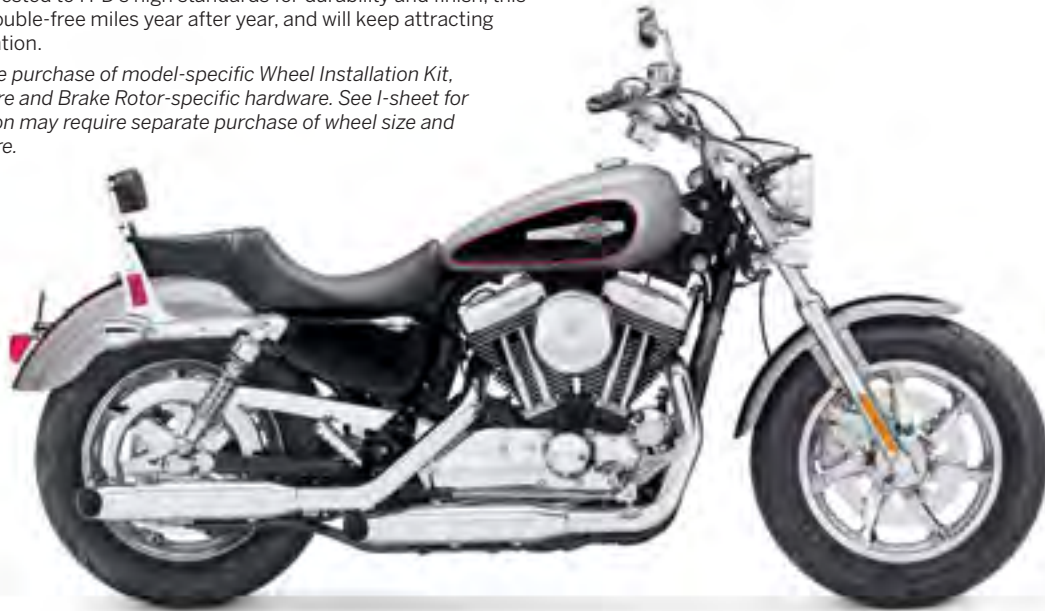

MIRROR CHROME MACHETE CUSTOM WHEELS (SHOWN ON SPORTSTER® MODEL)



Mirror Chrome Machete Wheel – 21" Front



Mirror Chrome Machete Wheel – 16" Front



Mirror Chrome Billet Sprocket Machete Wheel

### 21" Front

Fits '14-later XL883N and XL1200V models. Also fits '00-'13 XL models (except XL883R, XL1200R, XL1200S, XL1200X, '11-later XL883L, '11-later XL1200C and XL1200T).

**43300367** Mirror Chrome. **\$799.95**

### 16" Front

Fits '07-later FLS, FLST, FLSTC and FLSTN models.

**43300369** Mirror Chrome. **\$799.95**

Fits '10-later XL1200X and '11-later XL1200C models.

**43300371** Mirror Chrome. **\$799.95**

### 16" Rear

Fits '08-later FXS, FLS, FLSTC and FLSTN models.

**40900088** Mirror Chrome. **\$799.95**

Fits '00-later XL models (except '11-later XL883L and XL1200T).

**40900370** Mirror Chrome. **\$799.95**

See pages 766-770 for custom sprocket and brake rotor options.

### Shown with:

#### MACHETE BILLET SPROCKETS

Fits '07-later FXS, FXCW, FXCWC, FXSTD, FLS, FLSTC, FLSTN, FLSTSC and '12-later FLSTF and FLSTFB models (except Japan, Asia-Pacific and Brazil models). Requires separate purchase of model-specific sprocket mounting hardware.

**42200066** Chrome. **\$399.95**

Fits '04-later XL and '09-'13 XR models (except Japan models). Requires separate purchase of model-specific sprocket mounting hardware.

**42200068** Chrome. **\$399.95**

## MACHETE CUSTOM WHEELS – BLACK ICE

Like the swinging sword of a clandestine warrior, the stealth black Machete wheel delivers a powerful impact. The liquid-look black ice finish and the 3-dimensional cutting edge spokes shimmer in the light and reflect your sinister mood. Tested to H-D's high standards for durability and finish, this wheel will give trouble-free miles year after year, and will keep attracting the crowd's attention.

Requires separate purchase of model-specific Wheel Installation Kit, Sprocket hardware and Brake Rotor-specific hardware. See I-sheet for details. Installation may require separate purchase of wheel size and model-specific tire.



**BLACK ICE MACHETE CUSTOM WHEELS (SHOWN ON SPORTSTER® MODEL)**



**Black Ice Machete Wheel –  
21" Front**



**Black Ice Machete Wheel –  
16" Front**



**Gloss Black Billet Sprocket  
Machete Wheel**

### 21" Front

Fits '14-later XL883N and XL1200V models. Also fits '00-'13 XL models (except XL883R, XL1200R, XL1200S, XL1200X, '11-later XL883L, '11-later XL1200C and XL1200T).

**43300368** Black Ice. **\$799.95**

### 16" Front

Fits '07-later FLS, FLST, FLSTC and FLSTN models.

**43300370** Black Ice. **\$799.95**

Fits '10-later XL1200X and '11-later XL1200C models.

**43300372** Black Ice. **\$799.95**

### 16" Rear

Fits '08-later FXS, FLS, FLSTC and FLSTN models.

**40900089** Black Ice. **\$799.95**

Fits '00-later XL models (except '11-later XL883L and XL1200T).

**40900371** Black Ice. **\$799.95**

### Shown with:

#### MACHETE BILLET SPROCKETS

Fits '07-later FXS, FXCW, FXCWC, FXSTD, FLS, FLSTC, FLSTN, FLSTSC and '12-later FLSTF and FLSTFB models (except Japan, Asia-Pacific and Brazil models). Requires separate purchase of model-specific sprocket mounting hardware.

**42200067** Gloss Black. **\$399.95**

Fits '04-later XL and '09-'13 XR models (except Japan models). Requires separate purchase of model-specific sprocket mounting hardware.

**42200069** Gloss Black. **\$399.95**

See pages 767-770 for custom sprocket and brake rotor options.



# 744 WHEELS

Slicer

## SLICER CUSTOM WHEELS

Cut to the bone. The seven minimalist spokes radiate from the center hub and grasp the rim with an iron fist. The mirror-chrome finish and the faceted spokes collect the light and throw it back in a brilliant display. Tested to H-D's high standards for durability and finish, this wheel will give you years of trouble-free miles.

*Requires separate purchase of model-specific Wheel Installation Kit, Sprocket hardware and Brake Rotor-specific hardware. See I-sheet for details. Installation may require separate purchase of wheel size and model-specific tire.*



SLICER CUSTOM WHEELS (SHOWN ON ROAD KING® MODEL)



Mirror Chrome Slicer Wheel –  
17" Front



Mirror Chrome Slicer Wheel –  
16" Rear



Polished Rotors

### 17" Front

**43300388** Chrome. **\$799.95**  
Fits '14-later Touring models (except CVO™ unless originally equipped with Slicer wheels). Does not fit Trike models. Requires separate purchase of (2) Polished Brake Rotors P/N 41500040.

### 16" Rear

**40900332** Chrome. **\$799.95**  
Fits '14-later Touring models (except CVO unless originally equipped with Slicer wheels). Does not fit Trike models.

### Shown with:

#### POLISHED FLOATING BRAKE ROTORS

Complete the custom look with Floating Rotors. Styled to complement the Chisel and Slicer front wheel, the inner spider features a cutout design that mirrors the wheel's 7 distinctive open spokes. Rotors are polished to a mirror shine to match your customizing direction. Rotors include chrome mounting hardware.

**41500040** Polished. **\$159.95**  
Fits '09-later Touring models equipped with Chisel or Slicer Custom Front Wheel.

## AGGRESSOR CUSTOM WHEELS

Take the offensive. The unique forward slashing spokes echo the perfect balance of a traditional Ninja Kama blade, and blend into the rim for a seamless look. The mirror-finished slim spokes and surrounding rim add a light and open look to the bike's profile, but still pass all of H-D's rigorous tests for strength and durability.

*Requires separate purchase of model-specific Wheel Installation Kit, Sprocket hardware and Brake Rotor-specific hardware. See I-sheet for details. Installation may require separate purchase of wheel size and model-specific tire.*



AGGRESSOR CUSTOM WHEELS (SHOWN ON STREET GLIDE® MODEL)



Mirror Chrome Aggressor Wheel –  
19" Front



Mirror Chrome Aggressor Wheel –  
18" Rear



Aggressor Polished Rotors

### 19" Front

**43300321** Chrome. **\$849.95**  
Fits '14-later Touring models (except CVO™ unless originally equipped with Aggressor wheels). Does not fit Trike models. Requires separate purchase of Aggressor Brake Rotors P/N 41500102 (left) and 41500103 (right).

### 18" Rear

**40900329** Chrome. **\$849.95**  
Fits '14-later Touring models (except CVO unless originally equipped with Aggressor wheels). Does not fit Trike models.

### Shown with:

#### AGGRESSOR POLISHED FLOATING BRAKE ROTOR

Complete the custom look with Aggressor Floating Rotors. Styled to complement the Aggressor front wheel, the inner spider features a cutout design that mirrors the wheel's distinctive spoke pattern. Rotors are polished to match your customizing direction. Rotors include chrome mounting hardware.

Fits '14-later Touring models equipped with Aggressor Custom Front Wheel.

<b>41500102</b>	Front - Left.	<b>\$189.95</b>
<b>41500103</b>	Front – Right.	<b>\$189.95</b>

*Notice: The prices appearing in this catalog are the manufacturer's suggested retail prices. Actual retail prices may vary.*



# 746 WHEELS

Agitator

## AGITATOR CUSTOM WHEELS

Get ready to stir things up. The 7 forward-facing spokes of these Agitator Wheels dig deep into the soul for maximum custom impact. Spiraling from the custom hub, the flat profile spokes blend to the edge of the rim, minimizing the profile of the wheel and adding an open look that's easy to see around the matching Floating Brake Rotors. Available in your choice of finish, these wheels will set the stage for your custom direction.

Requires separate purchase of model-specific Wheel Installation Kit, Sprocket hardware and Brake Rotor-specific hardware. See I-sheet for details. Installation may require separate purchase of wheel size and model-specific tire.



AGITATOR CUSTOM WHEELS (SHOWN ON STREET GLIDE® MODEL)



Mirror Chrome Agitator Wheel –  
19" Front



Contrast Chrome Agitator Wheel –  
19" Front



Black Ice Agitator Wheel –  
19" Front

### 19" Front

Fits '09-later Road King®, Road Glide® and Street Glide® models and '14-later Ultra Classic® and Ultra Limited models (except '12-later CVO™ unless originally equipped with Agitator wheels). Does not fit Trike models. Requires separate purchase of Agitator Floating Brake Rotors.

**55071-11** Mirror Chrome. **\$799.95**

Fits '09-later Touring models (except '12-later CVO unless originally equipped with Agitator wheels). Does not fit Trike models. Requires separate purchase of Agitator Floating Brake Rotors.

**55070-11** Contrast Chrome. **\$649.95**

Fits '09-later Touring models (except '12-later CVO unless originally equipped with Agitator wheels). Does not fit Trike models. Requires separate purchase of Agitator Floating Brake Rotors.

**43300115** Black Ice. **\$799.95**

### 18" Front

Fits '09-later Road King, Road Glide and Street Glide models and '14-later Ultra Classic and Ultra Limited models (except '12-later CVO unless originally equipped with Agitator wheels). Does not fit Trike models. Requires separate purchase of Agitator Floating Brake Rotors.

**47957-10** Mirror Chrome. **\$799.95**

Fits '09-later Touring models (except '12-later CVO unless originally equipped with Agitator wheels). Does not fit Trike models. Requires separate purchase of Agitator Floating Brake Rotors.

**40268-10** Contrast Chrome. **\$649.95**

### 18" Rear

Fits '09-later Touring models (except '12-later CVO unless originally equipped with Agitator wheels). Does not fit Trike models.

**47951-10** Mirror Chrome. **\$799.95**

**40225-10** Contrast Chrome. **\$649.95**

**40900112** Black Ice. **\$799.95**

See page 767 for matching Agitator brake rotors.

## ROULETTE CUSTOM WHEELS

When you take this wheel for a spin, you're always a winner. Stunning cast aluminum wheel features 11 slim spokes that blend with the rim for eye-catching style. The unique spoke shape stands proud on the rim's edge, mimicking the pockets on a roulette wheel. The surface catches and reflects light, just as the raised ridges deflect the spinning roulette ball. Available in your choice of finish, these wheels will add a sinister look to your custom ride.

*Requires separate purchase of model-specific Wheel Installation Kit, Sprocket hardware and Brake Rotor-specific hardware. See I-sheet for details. Installation may require separate purchase of wheel size and model-specific tire.*



ROULETTE CUSTOM WHEELS (SHOWN ON STREET GLIDE® MODEL)



**Mirror Chrome Roulette Wheel – 17" Front**



**Contrast Chrome Roulette Wheel – 17" Front**



**Black Ice Roulette Wheel – 17" Front**

### 17" Front

Fits '09-later Touring models (except '12-later CVO™). Does not fit Trike models.

<b>42171-09</b>	Mirror Chrome.	<b>\$799.95</b>
<b>55065-10</b>	Contrast Chrome.	<b>\$649.95</b>
<b>43300116</b>	Black Ice.	<b>\$799.95</b>

### 16" Rear

Fits '09-later Touring models (except '12-later CVO). Does not fit Trike models.

<b>42170-09</b>	Mirror Chrome.	<b>\$799.95</b>
<b>55064-10</b>	Contrast Chrome.	<b>\$649.95</b>
<b>40900113</b>	Black Ice.	<b>\$799.95</b>

See pages 767-770 for matching Teardrop and other custom brake rotor options.



# 748 WHEELS

Impeller

## IMPELLER CUSTOM WHEELS

Shift into a higher gear. Add a custom touch of chrome without changing the distinctive style of your Touring motorcycle. These custom finished versions of the 10-spoke Original Equipment cast aluminum wheels are the perfect marriage of tough and mechanical with stunning and dazzling. Available in a 100% polished brilliant mirror chrome finish, these wheels have undergone hundreds of hours of real-world testing to meet the highest standards of performance and durability.

Requires separate purchase of model-specific Wheel Installation Kit, Sprocket hardware and Brake Rotor-specific hardware. See I-sheet for details. Installation may require separate purchase of wheel size and model-specific tire.



IMPELLER CUSTOM WHEELS (SHOWN ON ELECTRA GLIDE® MODEL)



Mirror Chrome Impeller Wheel –  
17" Front



Contrast Chrome Impeller Wheel –  
17" Front



Polished Rotors

### 17" Front

**43300386** Contrast Chrome. **\$549.95**  
Fits '09-later Touring models (except '12-later CVO™).  
Does not fit Trike models.

**43300338** Mirror Chrome. **\$659.95**  
Fits '09-later Touring models (except '12-later CVO).  
Does not fit Trike models.

### 16" Rear

**40900391** Contrast Chrome. **\$549.95**  
Fits '09-later Touring models (except '12-later CVO).  
Does not fit Trike models.

**40900348** Mirror Chrome. **\$659.95**  
Fits '09-later Touring models (except '12-later CVO).  
Does not fit Trike models.

### Shown with:

#### POLISHED BRAKE ROTORS – FRONT

A perfect complement to stock or custom wheels. Manufactured to Original Equipment specifications for exact fit, these rotors are meticulously polished to achieve a chrome-like appearance. Rotors are sold individually and include chrome installation hardware.

**41500094** **\$189.95**

Fits '14-later Touring models (except FLHRC, FLHRSE and FLHTKSE) with Original Equipment, Enforcer or Impeller wheels. Also fits '09-'13 Touring models equipped with Enforcer or Impeller wheels.

## ENFORCER CUSTOM WHEELS

Bring on the bling! Add a custom touch without changing the distinctive style of your Touring motorcycle. These 100% polished and mirror chrome plated versions of the split 5-spoke Original Equipment cast aluminum wheels broadcast stunning reflections, even while standing still. These wheels have undergone hundreds of hours of real-world testing to meet the highest standards of performance and durability.

*Requires separate purchase of model-specific Wheel Installation Kit, Sprocket hardware and Brake Rotor-specific hardware. See I-sheet for details. Installation may require separate purchase of wheel size and model-specific tire.*



ENFORCER CUSTOM WHEELS (SHOWN ON STREET GLIDE® MODEL)



Mirror Chrome Enforcer Wheel –  
19" Front

### 19" Front

**43300336** Mirror Chrome. **\$659.95**  
Fits '09-later Touring models (except '12-later CVO™).  
Does not fit Trike models.



Mirror Chrome Enforcer Wheel –  
16" Rear

### 16" Rear

**40900346** Mirror Chrome. **\$659.95**  
Fits '09-later Touring models (except '12-later CVO).  
Does not fit Trike models.



Polished Rotors

### Shown with:

#### POLISHED BRAKE ROTORS – FRONT

A perfect complement to stock or custom wheels. Manufactured to Original Equipment specifications for exact fit, these rotors are meticulously polished to achieve a chrome-like appearance. Rotors are sold individually and include chrome installation hardware.

#### 41500094

**\$189.95**

Fits '14-later Touring models (except FLHRC, FLHRSE and FLHTKSE) with Original Equipment, Enforcer or Impeller wheels. Also fits '09-'13 Touring models equipped with Enforcer or Impeller wheels.



# 750 WHEELS

Chisel

## CHISEL CUSTOM WHEELS

Honed to a fine edge. These wide-open cast aluminum wheels feature 7 narrow-profile split spokes that radiate from a minimalistic hub. The pedestal-mounted matching floating brake rotors let you see more of the front wheel and the resulting see-through effect visually lightens the bike's profile to add visual interest. Available in your choice of finish, these wheels will complement any customizing style.

*Requires separate purchase of model-specific Wheel Installation Kit, Sprocket hardware and Brake Rotor-specific hardware. See I-sheet for details. Installation may require separate purchase of wheel size and model-specific tire.*



CHISEL CUSTOM WHEELS (SHOWN ON ROAD KING® MODEL)



**Contrast Chrome Chisel Wheel – 17" Front**



**Mirror Chrome Chisel Wheel – 17" Front**



**Polished Rotors**

### 17" Front

Fits '09-later Touring models (except '12-later CVO™ unless originally equipped with Chisel wheels). Does not fit Trike models. Requires separate purchase of (2) Polished Floating Brake Rotors P/N 41500040.

<b>43300057</b>	Mirror Chrome.	<b>\$799.95</b>
<b>43300059</b>	Contrast Chrome.	<b>\$649.95</b>

### 16" Rear

Fits '09-later Touring models (except '12-later CVO unless originally equipped with Chisel wheels). Does not fit Trike models.

<b>40900067</b>	Mirror Chrome.	<b>\$799.95</b>
<b>40900069</b>	Contrast Chrome.	<b>\$649.95</b>

### Shown with:

#### POLISHED FLOATING BRAKE ROTORS

Complete the custom look with Floating Rotors. Styled to complement the Chisel and Slicer front wheel, the inner spider features a cutout design that mirrors the wheel's 7 distinctive open spokes. Rotors are polished to a mirror shine to match your customizing direction. Rotors include chrome mounting hardware.

<b>41500040</b>	Polished.	<b>\$159.95</b>
-----------------	-----------	-----------------

Fits '09-later Touring models equipped with Chisel or Slicer Custom Front Wheel.

*Notice: The prices appearing in this catalog are the manufacturer's suggested retail prices. Actual retail prices may vary.*

## ANARCHY 5-SPOKE WHEELS

The 5 beefy spokes of this custom wheel dramatically change the look of your Touring model or Trike. The "ball-milled" spokes radiate from the unique center hub to blend with the machined rim, opening the bike for a light, sporting profile. Available in your choice of finish, these wheels add a true hot-rod direction to your ride.

*Requires separate purchase of model-specific Wheel Installation Kit, Sprocket hardware and Brake Rotor-specific hardware. See I-sheet for details. Installation may require separate purchase of wheel size and model-specific tire.*



ANARCHY 5-SPOKE WHEELS (SHOWN ON ROAD KING® MODEL)



Mirror Chrome Anarchy Wheel –  
18" Front



Contrast Chrome Anarchy Wheel –  
18" Front



Polished Rotors

### 18" Front

Fits '09-later Touring, (except '12-later CVO™) FLHXXX and FLHTCUTG models. Requires separate purchase of (2) Open Floating Brake Rotors P/N 41500012A (polished) or 44553-06A (raw).

<b>55066-11</b>	Mirror Chrome.	<b>\$799.95</b>
<b>55128-11</b>	Contrast Chrome.	<b>\$649.95</b>

### 18" Rear

Fits '09-later Touring models. (except '12-later CVO) Does not fit Trike models.

<b>55067-11</b>	Mirror Chrome.	<b>\$799.95</b>
<b>55129-11</b>	Contrast Chrome.	<b>\$649.95</b>

### 16" Rear

Fits '09-later FLHXXX and FLHTCUTG models (US, Canada and Japan only). Requires separate purchase of hub cap and 16" tire. See your dealer or instruction sheet for specific details.

<b>55069-11</b>	Mirror Chrome.	<b>\$799.95</b>
<b>55130-11</b>	Contrast Chrome.	<b>\$649.95</b>

### Shown with:

#### OPEN FLOATING BRAKE ROTORS

Complete the custom look with open design Floating Brake Rotors, styled to complement a variety of custom wheels. Rotors are sold individually.

Fits '06-later VRSC™ and Dyna® and '08-later Touring and Trike models. Requires Original Equipment or Accessory wheel with 6.7" bolt circle rotor mount. Does not fit Enforcer or Impeller wheels.

<b>41500012A</b>	Polished – Front.	<b>\$149.95</b>
<b>44553-06A</b>	Raw – Front.	<b>\$119.95</b>

*Notice: The prices appearing in this catalog are the manufacturer's suggested retail prices. Actual retail prices may vary.*



# 752 WHEELS

Knuckles

## KNUCKLES 28-SPOKE CUSTOM WHEELS

Add a custom look without changing the distinctive style of your Touring motorcycle. These custom finished versions of the Original Equipment 28-spoke cast aluminum wheels cast glowing reflections, even while standing still. Available in brilliant mirror chrome or a rich contrast black and chrome finish to match your mood.

*Requires separate purchase of model-specific Wheel Installation Kit, Sprocket hardware and Brake Rotor-specific hardware. See I-sheet for details. Installation may require separate purchase of wheel size and model-specific tire.*



**KNUCKLES 28-SPOKE CUSTOM WHEELS (SHOWN ON ULTRA CLASSIC® MODEL)**



**Mirror Chrome Knuckles Wheel –  
17" Front**



**Contrast Chrome Knuckles Wheel –  
17" Front**

### 17" Front

Fits '09-later Touring models (except '12-later CVO™). Does not fit Trike models.

<b>55060-10</b>	Mirror Chrome.	<b>\$659.95</b>
<b>42195-10</b>	Contrast Chrome.	<b>\$559.95</b>

### 16" Rear

Fits '09-later Touring models (except '12-later CVO). Does not fit Trike models.

<b>55062-10</b>	Mirror Chrome.	<b>\$659.95</b>
<b>42196-10</b>	Contrast Chrome.	<b>\$559.95</b>

*See pages 767-770 for polished and other custom brake rotor options.*

## BLADE CUSTOM WHEELS

Slash your way to the front of the custom pack. Slick custom design features 10 slim spokes that flow from the center hub and spiral rearward to blend with the outer rim. Forged for strength from 6061 aluminum, these wheels are available in your choice of finish.

*Requires separate purchase of model-specific Wheel Installation Kit, Sprocket hardware and Brake Rotor-specific hardware. See I-sheet for details. Installation may require separate purchase of wheel size and model-specific tire.*



BLADE CUSTOM WHEELS (SHOWN ON STREET GLIDE® MODEL)



Mirror Chrome Blade Wheel –  
18" Front



Cut Back Black Blade Wheel –  
18" Front



Polished Rotors

### 18" Front

Fits '04-later Touring models (except '12-later CVO™). Does not fit Trike models. Requires separate purchase of (2) Open Brake Rotors P/N 41500012A (polished) or 44553-06A (raw).

<b>43300008</b>	Mirror Chrome.	<b>\$799.95</b>
<b>43300034</b>	Cut Back Black.	<b>\$749.95</b>

### 16" Front

Fits '00-'08 Touring models. Also fits '09-later FLHRC models.

<b>40820-08</b>	Mirror Chrome.	<b>\$799.95</b>
-----------------	----------------	-----------------

### 18" Rear

Fits '09-later Touring models (except '12-later CVO). Does not fit Trike models.

<b>40900009</b>	Mirror Chrome.	<b>\$799.95</b>
<b>40900046</b>	Cut Back Black.	<b>\$749.95</b>

### Shown with:

#### OPEN FLOATING BRAKE ROTORS

Complete the custom look with open design Floating Brake Rotors, styled to complement a variety of custom wheels. Rotors are sold individually.

Fits '06-later VRSC™ and Dyna®, and '08-later Touring and Trike models. Requires Original Equipment or Accessory wheel with 6.7" bolt circle rotor mount. Does not fit Enforcer or Impeller wheels.

<b>41500012A</b>	Polished – Front.	<b>\$149.95</b>
<b>44553-06A</b>	Raw – Front.	<b>\$119.95</b>



# 754 WHEELS

Airstrike

## AIRSTRIKE CUSTOM WHEELS

Hit your custom target. The extensive polishing provides the wheel with a glass-like surface and the wide-open slots and the reflections almost make this wheel disappear. Teamed with a low-profile front tire and polished brake rotors, this custom wheel adds visual lightness to the front end of your Touring bike.

*Requires separate purchase of model-specific Wheel Installation Kit, Sprocket hardware and Brake Rotor-specific hardware. See I-sheet for details. Installation may require separate purchase of wheel size and model-specific tire.*



AIRSTRIKE CUSTOM WHEELS (SHOWN ON ROAD KING® MODEL)



Mirror Chrome Airstrike Wheel –  
18" Front



Black Ice Airstrike Wheel –  
18" Front

### 18" Front

Fits '09-later Touring models (except '12-later CVO™). Does not fit Trike models.

<b>55056-10</b>	Mirror Chrome.	<b>\$659.95</b>
<b>43300118</b>	Black Ice.	<b>\$659.95</b>

### 16" Rear

Fits '09-later Touring models (except '12-later CVO). Does not fit Trike models.

<b>55058-10</b>	Mirror Chrome.	<b>\$659.95</b>
<b>40900115</b>	Black Ice.	<b>\$659.95</b>

*See pages 767-770 for polished and other custom brake rotor options.*

## 9-SPOKE CAST WHEELS

Styled to match the popular 9-spoke traditional Touring wheel, these wheels utilize tooling developed specifically to give a near perfect finish without the “waves” created when polishing the Original Equipment cast wheel. The rib on the Original Equipment wheel spoke has been removed to provide a smooth uninterrupted look and countless hours of polishing result in a superior finish.

*Requires separate purchase of model-specific Wheel Installation Kit, Sprocket hardware and Brake Rotor-specific hardware. See I-sheet for details. Installation may require separate purchase of wheel size and model-specific tire.*



9-SPOKE CAST WHEELS (SHOWN ON ELECTRA GLIDE® CLASSIC MODEL)



Chrome 9-Spoke Wheel –  
16" Front



Black Ice 9-Spoke Wheel –  
17" Front

### 17" Front

**41886-09** Chrome. **\$659.95**  
Fits '09-later Touring models (except '12-later CVO™).  
Does not fit Trike models. Also fits '09-'11 Sidecars.

**43300114** Black Ice. **\$659.95**  
Fits '09-later Touring models (except '12-later CVO).  
Does not fit Trike models. Also fits '09-'11 Sidecars.

### 16" Front

**41880-07** Chrome. **\$659.95**  
Fits '00-later FLS, FLST, FLSTC, FLSTN, '00-'06 FLSTF  
(except '06 FLSTFSE2) and '14-later FLSTNSE models.

**41886-07** Chrome. **\$659.95**  
Fits '09-later FLHRC models. Also fits '00-'08  
Touring models.

### 16" Rear

**41889-09** Chrome. **\$659.95**  
Fits '09-later Touring models (except '12-later CVO).  
Does not fit Trike models.

**41883-07** Chrome. **\$659.95**  
Fits '03-'07 FLST, FLSTN, FLSTC, '03-'06 FLSTF  
(except FLSTFSE2) and '03-'05 FXST, FXSTB and  
FXSTS models.

**41889-07** Chrome. **\$659.95**  
Fits '00-later XL (except XL1200T and '11-later XL  
883L), '00-'05 Dyna®, '00-'02 Softail® (except FXSTD)  
and '00-'08 Touring models.

### 16" Rear (continued)

**40754-08** Chrome. **\$659.95**  
Fits '08-later FXS, FLS, FLSTN, FLSTC and '14-later  
FLSTNSE models.

**40900111** Black Ice. **\$659.95**  
Fits '09-later Touring models (except '12-later CVO).  
Does not fit Trike models.

*See pages 767-770 for custom sprocket and  
brake rotor options.*



# 756 WHEELS

Road Winder™

## ROAD WINDER™ CUSTOM WHEELS

Take your custom ride in a new direction. The directional spokes of the one-piece Road Winder™ Wheel add the look of forward motion even while standing still. The slim spokes open the wheel visually and showcase the available matching brake rotors and sprockets.

*Requires separate purchase of model-specific Wheel Installation Kit, Sprocket hardware and Brake Rotor-specific hardware. See I-sheet for details. Installation may require separate purchase of wheel size and model-specific tire.*



ROAD WINDER CUSTOM WHEELS (SHOWN ON STREET GLIDE® MODEL)



Mirror Chrome Road Winder Wheel –  
18" Front



Cut Back Black Road Winder Wheel –  
18" Front



Polished Rotors

### 18" Front

Fits '09-later Touring models (except '12-later CVO™). Does not fit Trike models. Requires separate purchase of (2) Open Brake Rotors P/N 41500012A (polished) or 44553-06A (raw).

<b>43300062</b>	Mirror Chrome.	<b>\$799.95</b>
<b>43300064</b>	Cut Back Black.	<b>\$749.95</b>

### 18" Rear

Fits '09-later Touring models (except '12-later CVO). Does not fit Trike models.

<b>40900071</b>	Mirror Chrome.	<b>\$799.95</b>
<b>40900074</b>	Cut Back Black.	<b>\$749.95</b>

### Shown with:

#### OPEN FLOATING BRAKE ROTORS

Complete the custom look with open design Floating Brake Rotors, styled to complement a variety of custom wheels. Rotors are sold individually.

Fits '06-later VRSC™ and Dyna® and '08-later Touring and Trike models. Requires Original Equipment or Accessory wheel with 6.7" bolt circle rotor mount. Does not fit Enforcer or Impeller wheels.

<b>41500012A</b>	Polished – Front.	<b>\$149.95</b>
<b>44553-06A</b>	Raw – Front.	<b>\$119.95</b>

See pages 767-770 for matching Road Winder Rotors and Sprockets.

*Notice: The prices appearing in this catalog are the manufacturer's suggested retail prices. Actual retail prices may vary.*

## STINGER CUSTOM WHEELS

Scratch your customizing itch. This cutting edge 5-spoke Stinger Wheel is designed to draw your eye and hold your attention. The spiral spokes radiate from the fluted hub imparting a sense of motion and their slim cross section creates an open and airy profile. These fully polished and mirror-chrome finished 18" wheels feature a deeply notched rim that adds visual interest and can be accented with matching Stinger Sprockets and custom wave-accented Floating Brake Rotors. These cast aluminum wheels have undergone hundreds of hours of real-world testing to meet the highest standards of performance and durability.

*Requires separate purchase of model-specific Wheel Installation Kit, Sprocket hardware and Brake Rotor-specific hardware. See I-sheet for details. Installation may require separate purchase of wheel size and model-specific tire.*



STINGER CUSTOM WHEELS (SHOWN ON FAT BOY® MODEL)



Stinger Wheel – 18" Front



Stinger Sprocket



Stinger Rotor

### 18" Front

**47831-10** Fits '08-later FXDF and FXDFSE/2 models. **\$799.95**

**41503-10** Fits '08-later FLSTF, FLSTFB and FLSTSB models. **\$799.95**

### 18" Rear

**47835-10** Fits '08-later FXDF and FXDFSE/2 models. **\$799.95**

**41509-10** Fits '08-later FXST, FXSTB, FXSTC, FLSTF, FLSTFB and FLSTSB models. **\$799.95**

### Shown with:

#### STINGER BILLET SPROCKETS

Fits '07-later Dyna models (except Japan models and Brazilian FLD). Requires separate purchase of model-specific sprocket mounting hardware.

**37833-10** Stinger. **\$399.95**

Fits '07-'11 FXST, FXSTB, FXSTC, FLSTF, FLSTFB and FLSTSB models (except Japan models). Fits '07-later FXST, FXSTB, FLSTF and FLSTFB models for Asia-Pacific and Brazil. Requires separate purchase of model-specific sprocket mounting hardware.

**37834-10** Stinger. **\$399.95**

Fits '07-later FXCW, FXCWC, FXS, FXSB, FXSTD, FLS, FLSTC, FLSTN, FLSTSC and '12-later FLSTF and FLSTFB models. Does not fit Japan models. Requires separate purchase of model-specific sprocket mounting hardware.

**42200030** Stinger. **\$399.95**

### Shown with:

#### STINGER CUSTOM FLOATING BRAKE ROTORS

##### Front Left

Fits '00-'14 Softail® models.

**41500036** Chrome Inner, Polished Outer. **\$249.95**

**48993-10** Chrome Inner, Raw Outer. **\$189.95**

Fits '06-later Dyna® and '15-later Softail models with barrel-shaped (3.25" bolt circle) wheel hub.

**41500032** Chrome Inner, Polished Outer. **\$249.95**

**48977-10** Chrome Inner, Raw Outer. **\$189.95**

##### Front Right

Fits '06-later Dyna models with dual disc brakes and barrel-shaped (3.25" bolt circle) wheel hub.

**41500034** Chrome Inner, Polished Outer. **\$249.95**

**48978-10** Chrome Inner, Raw Outer. **\$189.95**

##### Rear

Fits '00-later Dyna and Softail models.

**41500038** Chrome Inner, Polished Outer. **\$249.95**

**48979-10** Chrome Inner, Raw Outer. **\$189.95**

See pages 767-770 for custom sprocket and brake rotor options.



# 758 WHEELS

Turbine

## TURBINE CUSTOM WHEELS

Bring the gleam and add some edge. These cast aluminum "Turbine"-style wheels feature 21 spokes which extend all the way to the edge of the rim, creating the illusion of a larger wheel diameter. Original Equipment on the CVO™ Breakout® model, the visually stunning wheels are meticulously polished and chrome-plated for maximum reflective effect. All Genuine Motor Accessory wheels have been certified by Harley-Davidson® to perform to our tough vehicle standards for quality and durability.

*Requires separate purchase of model-specific Wheel Installation Kit, Sprocket hardware and Brake Rotor-specific hardware. See I-sheet for details. Installation may require separate purchase of wheel size and model-specific tire.*

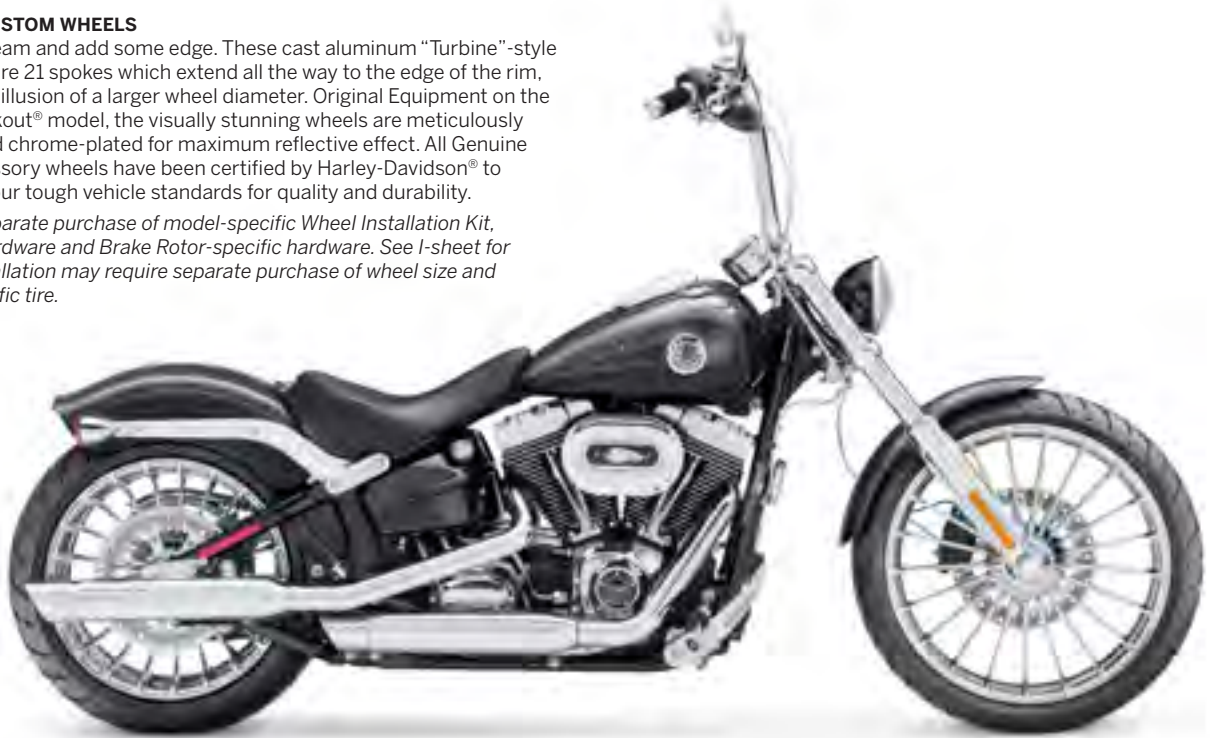

TURBINE CUSTOM WHEELS (SHOWN ON SOFTAIL® BREAKOUT® MODEL)



Mirror Chrome Turbine Wheel –  
21" Front



Contrast Chrome Turbine Wheel –  
21" Front

### 21" Front

Fits '13-later FXSB and FXSBSE models.

<b>43300315</b>	Contrast Chrome.	<b>\$699.95</b>
<b>43300047</b>	Mirror Chrome.	<b>\$849.95</b>

### 18" Rear

Fits '13-later FXSB and FXSBSE models.

<b>40900324</b>	Contrast Chrome.	<b>\$699.95</b>
<b>40900057</b>	Mirror Chrome.	<b>\$849.95</b>

*See pages 767-770 for custom sprocket and brake rotor options.*

## REAPER CUSTOM WHEELS

Step out from behind the shroud. Brilliant cast wheels feature a forward slashing scythe design that radiates from the compact center hub. Honed to a razor's edge, the 5 curved blade spokes blend with the rim to provide a look of continuous motion. Cast of premium quality aluminum, the hub, spokes and rim are polished glass-smooth.

Requires separate purchase of model-specific Wheel Installation Kit, Sprocket hardware and Brake Rotor-specific hardware. See I-sheet for details. Installation may require separate purchase of wheel size and model-specific tire.



REAPER CUSTOM WHEELS (SHOWN ON STREET BOB® MODEL)



Mirror Chrome Reaper Wheel –  
19" Front



Black Ice Reaper Wheel –  
19" Front

### 21" Front

Fits '00-later FXS, FXST, FXSTD (except FXSTDSE), FXSTS, FXSTB, FXSTC and FXDWG models. Also fits '08 FXDSE2 models.

**40778-08** Mirror Chrome. **\$799.95**

### 19" Front

Fits '06-later Dyna® models (except FLD, FXDWG, FXDF, FXDFSE/2 and '14-later FXDL). Installation on models equipped with Original Equipment laced wheel will require separate purchase of Floating Brake Rotor.

**41983-08** Mirror Chrome. **\$799.95**

**43300198** Black Ice. **\$799.95**

### 18" Front

Fits '04-later Touring models (except '12-later CVO™). Does not fit Trike models. Requires separate purchase of Open Brake Rotors. See your Dealer or the instruction sheet for specific part numbers.

**40790-09** Mirror Chrome. **\$799.95**

### 17" Front

Fits '08-later FLSTF and FLSTFB models. Recommend separate purchase of Floating Brake Rotor.

**40779-08** Mirror Chrome. **\$799.95**

### 17" Rear

Fits '08-later FXST, FXSTB, FXSTC, FLSTF, FLSTFB and FLSTSB models.

**40802-08** Mirror Chrome. **\$799.95**

Fits '06-later Dyna (except FXDF and FXDFSE/2) and '00-'07 FXSTD models.

**41981-08** Mirror Chrome. **\$799.95**

**40900197** Black Ice. **\$799.95**

### 16" Rear

Fits '09-later Touring models (except '12-later CVO™). Does not fit Trike.

**40792-09** Mirror Chrome. **\$799.95**

See pages 767-770 for matching Reaper Rotors and Sprockets.



# 760 WHEELS

ThunderStar™

## THUNDERSTAR™ CUSTOM WHEELS

Impressive styling and performance all rolled into one, this premium quality cast aluminum wheel is named for its striking 5-spoke design. Available in mirror chrome finish, this wheel offers a captivating style.

*Requires separate purchase of model-specific Wheel Installation Kit, Sprocket hardware and Brake Rotor-specific hardware. See I-sheet for details. Installation may require separate purchase of wheel size and model-specific tire.*



THUNDERSTAR CUSTOM WHEELS (SHOWN ON DYNA® WIDE GLIDE® MODEL)



Mirror Chrome Thunderstar Wheel –  
21" Front



Mirror Chrome Thunderstar Wheel –  
17" Front

### 21" Front

Fits '00-later FXS, FXST, FXSTD (except FXSTDSE), FXSTS, FXSTB, FXSTC and '00-later FXDWG.

**43602-07** Mirror Chrome. **\$659.95**

### 19" Front

Fits '00-later XL (except XL1200T, XL1200X, '11-later XL883L and XL1200C) and '00-'05 Dyna® models (except FXDWG).

**44282-07** Mirror Chrome. **\$659.95**

### 17" Front

Fits '09-later Touring models (except '12-later CVO™). Does not fit Trike models.

**40966-09** Mirror Chrome. **\$659.95**

### 16" Front

Fits '00-later FLS, FLST, FLSTC, FLSTN and '00-'06 FLSTF models (except '06 FLSTFSE2).

**43609-07** Mirror Chrome. **\$659.95**

Fits '00-'08 Touring models. Also fits '09-later FLHRC models.

**43703-08** Mirror Chrome. **\$659.95**

### 16" Rear

Fits '09-later Touring models (except '12-later CVO). Does not fit Trike models.

**40881-09** Mirror Chrome. **\$659.95**

### 16" Rear

Fits '00-later XL (except XL1200T and '11-later XL883L), '00-'05 Dyna, '00-'02 Softail® (except FXSTD) and '00-'08 Touring models.

**43649-08** Mirror Chrome. **\$659.95**

Fits '03-'07 FLST, FLSTN, FLSTC, '03-'06 FLSTF (except FLSTFSE2) and '03-'05 FXST, FXSTB and FXSTS models.

**44544-08** Mirror Chrome. **\$659.95**

See pages 767-770 for matching ThunderStar Rotors and Sprockets.

**SLOTTED 6-SPOKE WHEELS**

A dramatic look that breaks the mold in motorcycle wheel styling. Available in your choice of finish, this stylish custom wheel incorporates the strength of twelve spokes into the illusion of a lightweight 6-spoke design. Fingerlike slots radiate from the center to the uniquely rounded smooth finishes on the inner and outer rim.

Requires separate purchase of model-specific Wheel Installation Kit, Sprocket hardware and Brake Rotor-specific hardware. See I-sheet for details. Installation may require separate purchase of wheel size and model-specific tire.



**SLOTTED 6-SPOKE WHEELS (SHOWN ON DYNA® WIDE GLIDE® MODEL)**



**Mirror Chrome Slotted 6-Spoke Wheel – 21" Front**



**Textured Chrome Slotted 6-Spoke Wheel – 21" Front**



**Textured Black Slotted 6-Spoke Wheel – 21" Front**

**21" Front**

Fits '00-later FXS, FXST, FXSTD (except FXSTDSE), FXSTS, FXSTB, FXSTC, '00-later FXDWG and '08 FXDSE2 models.

<b>43925-07</b>	Textured Black.	<b>\$459.95</b>
<b>43973-08</b>	Mirror Chrome.	<b>\$659.95</b>

Fits '14-later XL883N and XL1200V models. Fits '00-'13 XL (except XL1200X, '11-'13 XL883L and '11-'13 XL1200C) and '00-'05 Dyna® models (except FXDWG).

<b>44055-07</b>	Textured Chrome.	<b>\$559.95</b>
<b>44056-07</b>	Textured Black.	<b>\$459.95</b>

**19" Front**

Fits '06-later Dyna models (except FLD, FXDWG, FXDF and FXDFSE/2). Installation on models equipped with Original Equipment cast wheel will require separate purchase of Floating Brake Rotor.

<b>43538-09</b>	Mirror Chrome.	<b>\$659.95</b>
<b>43577-09</b>	Textured Black.	<b>\$459.95</b>

Fits '14-later XL883N and XL1200V models. Fits '00-'13 XL (except XL1200X, '11-'13 XL883L and '11-'13 XL1200C) and '00-'05 Dyna® models (except FXDWG).

<b>44057-07</b>	Textured Black.	<b>\$459.95</b>
-----------------	-----------------	-----------------

**16" Front**

Fits '00-'08 Touring models. Also fits '09-later FLHRC models.

<b>43920-08</b>	Textured Chrome.	<b>\$559.95</b>
<b>43921-08</b>	Textured Black.	<b>\$459.95</b>

Fits '00-later FLS, FLST, FLSTC, FLSTN and '00-'06 FLSTF models (except '06 FLSTFSE2).

<b>43918-07</b>	Textured Chrome.	<b>\$559.95</b>
<b>43919-07</b>	Textured Black.	<b>\$459.95</b>

**17" Rear**

Fits '06-later Dyna (except FXDF and FXDFSE/2) and '00-'07 FXSTD models.

<b>43942-07</b>	Textured Black.	<b>\$459.95</b>
<b>43972-08</b>	Mirror Chrome.	<b>\$659.95</b>

**16" Rear**

Fits '03-'07 FLST, FLSTN and FLSTC, '03-'06 FLSTF (except FLSTFSE2) and '03-'05 FXST, FXSTB and FXSTS models.

<b>43931-08</b>	Textured Black.	<b>\$459.95</b>
-----------------	-----------------	-----------------

Fits '00-later XL (except '14-later XL1200T and '11-later XL883L), '00-'05 Dyna, '00-'02 Softail® (except FXSTD) and '00-'08 Touring models.

<b>43928-08</b>	Textured Chrome.	<b>\$559.95</b>
<b>43929-08</b>	Textured Black.	<b>\$459.95</b>

See pages 766-770 for matching Slotted 6-Spoke Rotors and Sprockets.

Notice: The prices appearing in this catalog are the manufacturer's suggested retail prices. Actual retail prices may vary.



## 762 WHEELS

Switchblade/Vapor

### A. SWITCHBLADE CUSTOM WHEEL

Add the brilliance of chrome without changing the distinctive custom style of your Dyna® motorcycle. This meticulously polished and chrome-plated version of the Original Equipment 10-spoke cast aluminum wheel casts glowing reflections, even while standing still. These wheels, chromed to the same strict standards you have come to expect from Harley-Davidson, are plated using custom masking that provides contamination-free bolt holes and bearing bores. This allows the installed bearings to fit as precisely as on our Original Equipment wheels, so you can be confident these wheels will ride as smooth as they look. Requires separate purchase of model-specific Wheel Installation Kit, sprocket hardware and brake rotor-specific hardware. See I-sheet for details.

**40359-10** 19" Front. **\$659.95**

Fits '08-later Dyna models (except FLD, FXDWG, FXDF, FXDFSE/2 and '14-later FXDL). Installation on models equipped with Original Equipment laced wheel will require separate purchase of model-specific Floating Brake Rotor.

**40386-10** 17" Rear. **\$659.95**

Fits '08-later Dyna models (except FXDF and FXDFSE/2).

See pages 766-770 for custom sprocket and brake rotor options.

### B. VAPOR 5-SPOKE CUSTOM WHEEL

Add a splash of chrome without changing the distinctive custom style of your Switchback™ motorcycle. Countless hours of polishing result in a superior finish. These cast aluminum wheels have undergone hundreds of hours of real-world testing to meet the highest standards of performance and durability. Requires separate purchase of model-specific Wheel Installation Kit, sprocket hardware and brake rotor-specific hardware. See I-sheet for details.

**43300067** 18" Front. **\$559.95**

Fits '12-later Dyna FLD models.

**40900077** 17" Rear. **\$559.95**

Fits '08-later Dyna models (except FXDF and FXDFSE/2).

See pages 766-770 for custom sprocket and brake rotor options.



A. SWITCHBLADE CUSTOM WHEEL



B. VAPOR 5-SPOKE CUSTOM WHEEL

#### Model Family Fitment:

■ V-ROD   ■ SPORTSTER   ■ DYNA  
■ SOFTAIL   ■ TOURING

Notice: The prices appearing in this catalog are the manufacturer's suggested retail prices. Actual retail prices may vary.

# WHEELS 763

Typhoon/Magnum 5



C. TYPHOON CUSTOM WHEEL

## C. TYPHOON CUSTOM WHEEL

An intense storm is brewing. Nine arching spokes spin outward from the hub and blend seamlessly with the rim to add forward motion, even while standing still and the flat profile spokes and carved webs add visual intensity. Requires separate purchase of model-specific Wheel Installation Kit, Sprocket hardware and Brake Rotor-specific hardware. See I-sheet for details. Installation may require separate purchase of wheel size and model-specific tire.

### 21" Front

Fits '00-later FXS, FXST, FXSTD (except FXSTDSE), FXSTS, FXSTB, FXSTC, '00-later FXDWG and '08 FXDSE2 models.

**43300055** Cut Back Gloss Black. **\$459.95**

### 19" Front

Fits '06-later Dyna® models (except FLD, FXDWG, FXDF, FXDFSE/2 and '14-later FXDL). Installation on models equipped with Original Equipment laced wheel will require separate purchase of Floating Brake Rotor. Does not fit with chrome Front Wheel Spacer Kit P/N 41420-08.

**43300053** Cut Back Gloss Black. **\$459.95**

### 17" Rear

Fits '08-later FXST, FXSTB, FXSTC, FLSTF, FLSTFB and FLSTSB models.

**40900065** Cut Back Gloss Black. **\$459.95**

### 17" Rear

Fits '06-later Dyna (except FXDF and FXDFSE/2) and '00-'07 FXSTD models.

**40900063** Cut Back Gloss Black. **\$459.95**

See pages 765 for matching Typhoon Sprocket Covers.

## D. MAGNUM 5 CUSTOM WHEEL

Click off the safety and pull the trigger for a true custom ride. The bold, brawny design is inspired by the steel of a large-frame revolver. This one-piece cast aluminum wheel features high-impact styling, with 15 individual spokes that converge to form five distinct columns. The cast-in "rivets" visually tie the oval cross-section spokes to the rim and the hub and hit the styling target like a high-velocity bullet. Requires separate purchase of model-specific Wheel Installation Kit, Sprocket hardware and Brake Rotor-specific hardware. See I-sheet for details. Installation may require separate purchase of wheel size and model-specific tire.

### 21" Front

Fits '00-later FXS, FXST, FXSTD (except FXSTDSE), FXSTB, FXSTC, '00-later FXDWG and '08 FXDSE2 models.

**43300051** Cut Back Gloss Black. **\$459.95**

### 19" Front

Fits '06-later Dyna® models (except FLD, FXDWG, FXDF, FXDFSE/2 and '14-later FXDL). Installation on models equipped with Original Equipment laced wheel will require separate purchase of Floating Brake Rotor. Does not fit with chrome Front Wheel Spacer Kit P/N 41420-08.

**43300049** Cut Back Gloss Black. **\$459.95**

### 17" Rear

Fits '08-later FXST, FXSTB, FXSTC, FLSTF, FLSTFB and FLSTSB models.

**40900061** Cut Back Gloss Black. **\$459.95**

Fits '06-later Dyna (except FXDF and FXDFSE/2) and '00-'07 FXSTD models.

**40900059** Cut Back Gloss Black. **\$459.95**

See pages 765 for matching Magnum 5 Sprocket Covers.



D. MAGNUM 5 CUSTOM WHEEL

WHEELS

Notice: The prices appearing in this catalog are the manufacturer's suggested retail prices. Actual retail prices may vary.



## 764 WHEELS

Fat Bob® Slotted/Fat-X 5-Spoke

### A. FAT BOB® SLOTTED CUSTOM WHEEL – GLOSS BLACK CUT BACK

Come to the dark side. Add a sinister blacked-out look without changing the distinctive style of the Fat Bob® motorcycle. The Original Equipment slotted wheels are finished to a deep gloss black luster and then meticulously machined to expose the raw aluminum below. The contrasting aluminum beveled edge slots and accent spots add a genuine custom look without compromising strength or performance. All Genuine Motor Accessory wheels have been certified by Harley-Davidson® to perform to our tough vehicle standards for quality and durability. Requires separate purchase of model-specific Wheel Installation Kit.

Fits '08-later FXDF and FXDFSE/2 models.

<b>43300065</b>	16" Front.	<b>\$459.95</b>
<b>40900075</b>	16" Rear.	<b>\$459.95</b>

See pages 766-770 for custom sprocket and brake rotor options.



**A. FAT BOB SLOTTED CUSTOM WHEEL – GLOSS BLACK CUT BACK (SHOWN WITH CLASSIC BLACK FLOATING BRAKE ROTOR)**

### B. FAT-X 5-SPOKE WHEEL

Add a splash of chrome without changing the distinctive custom style of your Sportster® model. More than just a chrome-plated Original Equipment wheel, these 5-spoke wheels utilize tooling developed specifically for chrome-plating to give a near perfect finish without the "waves" created when polishing the Original Equipment cast wheel. Countless hours of polishing result in a superior finish. Special masking was developed to prevent plating corrosion inside bolt holes and bearing sleeve areas. All Genuine Motor Accessory wheels have been certified by Harley-Davidson to perform to our tough vehicle standards for quality and durability. Requires separate purchase of model-specific Wheel Installation Kit.

**43300045** 16" Front. **\$559.95**  
Fits '10-later XL1200X and '11-later XL1200C models.

**40900055** 16" Rear. **\$559.95**  
Fits '08-later XL models (except XL1200T and '11-later XL883L).

See pages 766-770 for custom sprocket and brake rotor options.



**B. FAT-X 5-SPOKE WHEEL**

**C. CHROME DISC REAR WHEEL**

### C. CHROME DISC REAR WHEEL

This meticulously polished and chrome-plated version of the Original Equipment solid rear wheel retains the raised rib design. Requires separate purchase of model-specific Wheel Installation Kit, Sprocket hardware and brake rotor-specific hardware. See I-sheet for details.

**41174-07** 17" Rear. **\$659.95**  
Fits '00-'07 FXSTD and '06-later Dyna models (except FXDF and FXDFSE/2).

### D. TRI GLIDE® 14-SPOKE WHEEL – MIRROR CHROME

Add the brilliance of chrome without changing the distinctive custom style of your Trike motorcycle. This meticulously polished and chrome-plated version of the Original Equipment 14-spoke cast aluminum wheel casts glowing reflections, even while standing still. These wheels, chromed to the same strict standards you have come to expect from Harley-Davidson, are plated using custom masking that provides contamination-free bolt holes and bearing bores. Requires separate purchase of model-specific Wheel Installation Kit and brake disc hardware.

**16" Front**  
**43300018** Chrome. **\$659.95**  
Fits '09-later FLHXXX and FLHTCUTG models.

**15" Rear**  
**40900025** Chrome. **\$659.95**  
Fits '09-later FLHXXX and FLHTCUTG models.



**D. 14-SPOKE WHEEL – MIRROR CHROME (SHOWN WITH POLISHED BRAKE ROTOR)**

Notice: The prices appearing in this catalog are the manufacturer's suggested retail prices. Actual retail prices may vary.

# WHEELS 765

## Sprocket Covers



**E. MAGNUM 5 SPROCKET COVER**



### E. MAGNUM 5 SPROCKET COVER

Styled to match the distinctive Magnum 5 Custom Wheel. Available in mirror-chrome or gloss black, this Sprocket Cover gives the appearance of having a custom sprocket at a fraction of the cost. Cover is easy to install with Original Equipment hardware or add the Chrome Hardware Kit P/N 94773-07 to your Dyna® or Softail® model for a finished look (sold separately).

Fits '07-later Dyna models (except FLD).

<b>40120-09</b>	Chrome.	<b>\$54.95</b>
<b>42200010</b>	Gloss Black.	<b>\$54.95</b>

Fits '07-later Softail models (except FLSTN5E, FXCW, FXCWC, FXSB and FXSB5E).

<b>40121-09</b>	Chrome.	<b>\$54.95</b>
<b>42200011</b>	Gloss Black.	<b>\$54.95</b>

### F. TYPHOON SPROCKET COVER

Styled to match the distinctive Typhoon Custom Wheel. Available in mirror-chrome or gloss black, this Sprocket Cover gives the appearance of having a custom sprocket at a fraction of the cost. Cover easily bolts on using the stock hardware or for a finished look, add the Chrome Hardware Kit P/N 94773-07 (sold separately).

Fits '07-later Dyna models.

<b>40142-08</b>	Chrome.	<b>\$49.95</b>
<b>42200012</b>	Gloss Black.	<b>\$49.95</b>

Fits '07-later Softail models (except FLSTN5E, FXCW, FXCWC, FXSB and FXSB5E).

<b>40150-08</b>	Chrome.	<b>\$49.95</b>
<b>42200013</b>	Gloss Black.	<b>\$49.95</b>



**F. TYPHOON SPROCKET COVER**



### G. SPROCKET COVER – CHROME

This Sprocket Cover gives the appearance of having a chrome sprocket at a fraction of the cost. It matches the styling of the Original Equipment sprocket and bolts on using the stock hardware.

<b>37757-07</b>	<b>\$49.95</b>
-----------------	----------------

Fits '07-later Softail (except FLSTN5E, FXCW, FXCWC, FXSB and FXSB5E).

<b>91347-00</b>	<b>\$49.95</b>
-----------------	----------------

Fits '00-'06 Softail models.

### H. CHROME "BIG SPOKE" SPROCKET COVER

Muscle rules. Big, beefy spokes define the distinctive hot rod styling and the small trapezoidal openings are reminiscent of Detroit's street performance wheels of the late '60s. The chrome-plated steel cover disguises the Original Equipment sprocket and complements both stock and custom wheels. Easy to install, this cover provides the look of a billet sprocket at a fraction of the cost.

<b>40124-10</b>	<b>\$49.95</b>
-----------------	----------------

Fits '04-later XL and XR models.



**G. SPROCKET COVER – CHROME**



**H. CHROME "BIG SPOKE" SPROCKET COVER**

#### Model Family Fitment:

V-ROD	SPORTSTER	DYNA
SOFTAIL	TOURING	

Notice: The prices appearing in this catalog are the manufacturer's suggested retail prices. Actual retail prices may vary.



# 766 WHEELS

## Sprockets

### A. BILLET SPROCKETS

Designed to complement the wheel's styling, these custom sprockets are manufactured from 6061-T6 forged billet aircraft aluminum and precision machined to exacting Original Equipment standards. Harley-Davidson® custom sprockets are finished with a proprietary process that combines the decorative chrome with a wear-resistant surface applied to the teeth.

Fits '04-later XL and '09-later XR models (except Japan models). Requires separate purchase of model-specific sprocket mounting hardware.

**40418-04** Slotted 6-Spoke. **\$399.95**

Fits '00-'05 Dyna® models. Requires separate purchase of model-specific sprocket mounting hardware.

**40451-01** Slotted 6-Spoke. **\$399.95**

**40096-00** Chrome ThunderStar™. **\$399.95**

Fits '07-later Dyna models (except Japan models and Brazilian FLD). Requires separate purchase of model-specific sprocket mounting hardware.

**40451-07** Slotted 6-Spoke. **\$399.95**

**37709-09** Reaper. **\$399.95**

**40410-09** Fang. **\$399.95**

**37833-10** Stinger. **\$399.95**

**42200001** Cut Back Gloss Black. **\$199.95**

**42200051** Reaper Gloss Black. **\$349.95**

Fits '04-'06 Touring models. Requires separate purchase of model-specific sprocket mounting hardware.

**40435-04** Chrome ThunderStar. **\$399.95**

Fits '00-'06 Softail® models (except '06 FXST, FXSTB, FXSTS and FLSTFSE). FXSTD models require Spacer Kit P/N 29786-01. Requires separate purchase of model-specific sprocket mounting hardware.

**40447-01** Slotted 6-Spoke. **\$399.95**

**40126-00** Chrome ThunderStar. **\$399.95**

**40474-03** Road Winder™. **\$399.95**

**46624-03** Mirror Chrome Disc. **\$399.95**

Fits '07-'11 FXST, FXSTB, FXSTC, FLSTF, FLSTFB and FLSTSB models (except Japan models). Fits '07-later FXST, FXSTB, FLSTF and FLSTFB models for Asia-Pacific and Brazil. Requires separate purchase of model-specific sprocket mounting hardware.

**37785-07** Blade. **\$399.95**

**40445-08** Reaper. **\$399.95**

**37834-10** Stinger. **\$399.95**

Fits '07-later FXCW, FXCWC, FXS, FXSB, FXSTD, FLS, FLSTC, FLSTN, FLSTSC, '12-later FLSTF and FLSTFB models. Does not fit Japan models. Requires separate purchase of model-specific sprocket mounting hardware.

**40447-07** Slotted 6-Spoke. **\$399.95**

**40126-07** Chrome ThunderStar. **\$399.95**

**37800-08** Blade. **\$399.95**

**40228-07** Solid Mirror Disc. **\$399.95**

**42200004** Cut Back Gloss Black. **\$199.95**

**42200030** Stinger. **\$399.95**

**42200031** Reaper. **\$399.95**

**42200007** Turbine. **\$399.95**



Slotted 6-Spoke



Road Winder



Reaper



Chrome ThunderStar



Blade



Stinger



Reaper Gloss Black



Mirror Chrome Disc



Fang



Solid Mirror Disc



Cut Back Gloss Black



Turbine

#### Model Family Fitment:

- V-ROD
- SPORTSTER
- DYNA
- SOFTAIL
- TOURING

Notice: The prices appearing in this catalog are the manufacturer's suggested retail prices. Actual retail prices may vary.

### A. BILLET SPROCKETS

**NEW**



**B. MACHETE BILLET SPROCKET – CHROME**

**NEW**



**B. MACHETE BILLET SPROCKET – GLOSS BLACK**

### B. MACHETE BILLET SPROCKETS

Designed to complement the wheel's styling, these custom sprockets are manufactured from 6061-T6 forged billet aircraft aluminum and precision machined to exacting Original Equipment standards. Finished with a proprietary process that combines the decorative chrome with a wear-resistant surface applied to the teeth. Requires separate purchase of model-specific sprocket mounting hardware.

Fits '07-later FXS, FXCW, FXCWC, FXSTD, FLS, FLSTC, FLSTN, FLSTSC, '12-later FLSTF and FLSTFB models, (except Japan, Asia-Pacific and Brazil models). Requires separate purchase of model-specific sprocket mounting hardware.

<b>42200066</b>	Machete – Chrome.	<b>\$399.95</b>
<b>42200067</b>	Machete – Gloss Black.	<b>\$399.95</b>

Fits '04-later XL and '09-'13 XR models (except Japan models). Requires separate purchase of model-specific sprocket mounting hardware.

<b>42200068</b>	Machete – Chrome.	<b>\$399.95</b>
<b>42200069</b>	Machete – Gloss Black.	<b>\$399.95</b>

### CUSTOM FLOATING BRAKE ROTORS

Complete the custom look with floating brake rotors, styled to complement Harley-Davidson® custom wheels. Rotors are sold individually and include chrome installation hardware.

### C. STINGER BRAKE ROTORS

**Front Left.** Fits '00-'14 Softail® models.

<b>41500036</b>	Chrome Inner, Polished Outer.	<b>\$249.95</b>
<b>48993-10</b>	Chrome Inner, Raw Outer.	<b>\$189.95</b>

**Front Left.** Fits '06-later Dyna® and '15-later Softail models with barrel-shaped (3.25" bolt circle) wheel hub.

<b>41500032</b>	Chrome Inner, Polished Outer.	<b>\$249.95</b>
<b>48977-10</b>	Chrome Inner, Raw Outer.	<b>\$189.95</b>

**Front Right.** Fits '06-later Dyna models with dual disc brakes and barrel-shaped (3.25" bolt circle) wheel hub.

<b>41500034</b>	Chrome Inner, Polished Outer.	<b>\$249.95</b>
<b>48978-10</b>	Chrome Inner, Raw Outer.	<b>\$189.95</b>

**Rear.** Fits '00-later Dyna and Softail models.

<b>41500038</b>	Chrome Inner, Polished Outer.	<b>\$249.95</b>
<b>48979-10</b>	Chrome Inner, Raw Outer.	<b>\$189.95</b>

### D. CHISEL/SLICER BRAKE ROTORS

**Front Left or Right.** Fits '09-later Touring models equipped with Chisel or Slicer Custom Front Wheel.

<b>41500040</b>	Polished.	<b>\$159.95</b>
-----------------	-----------	-----------------

### E. AGGRESSOR BRAKE ROTOR

**Front Left.** Fits '09-later Touring models equipped with Aggressor Custom Front Wheel.

<b>41500102</b>	Polished.	<b>\$189.95</b>
-----------------	-----------	-----------------

**Front Right.** Fits '09-later Touring models equipped with Aggressor Custom Front Wheel.

<b>41500103</b>	Polished.	<b>\$189.95</b>
-----------------	-----------	-----------------

### F. AGITATOR BRAKE ROTORS

**Front Left.** Fits '09-later Touring models equipped with Agitator Custom Front Wheel.

<b>41500007</b>	Chrome Inner, Polished Outer.	<b>\$209.95</b>
<b>41500053</b>	Gloss Black Inner, Polished Outer.	<b>\$209.95</b>
<b>41500002</b>	Chrome Inner, Raw Outer.	<b>\$189.95</b>
<b>49000-10</b>	Raw Inner, Raw Outer.	<b>\$99.95</b>

**Front Right.** Fits '09-later Touring models equipped with Agitator Custom Front Wheel.

<b>41500008</b>	Chrome Inner, Polished Outer.	<b>\$209.95</b>
<b>41500052</b>	Gloss Black Inner, Polished Outer.	<b>\$209.95</b>
<b>41500004</b>	Chrome Inner, Raw Outer.	<b>\$189.95</b>
<b>48981-10</b>	Raw Inner, Raw Outer.	<b>\$99.95</b>

**NEW**



**E. AGGRESSOR FLOATING BRAKE ROTORS**



**F. AGITATOR FLOATING BRAKE ROTORS – CHROME/POLISHED**



**F. AGITATOR FLOATING BRAKE ROTORS – GLOSS BLACK/POLISHED**



**F. AGITATOR FLOATING BRAKE ROTORS – CHROME/RAW**



# 768 WHEELS

## Brake Rotors

### A. FLOATING BRAKE ROTORS

Complete the custom look with floating brake rotors, styled to complement Original Equipment or custom wheels. Floating rotors feature a steel inner carrier that is shaped to accent the wheel, with a polished and drilled stainless steel outer disc that is precision-riveted in place. Rotors are sold individually and include chrome installation hardware.

#### Front

Fits '14-later XL, '06-later Dyna®, '15-later Softail® and '08-later Touring and Trike models. Requires Original Equipment or Accessory wheel with 3.25" bolt circle rotor mount.

<b>41500107</b>	Split 7 Spoke, Polished.	<b>\$189.95</b>
<b>41500108</b>	Split 7 Spoke, Black.	<b>\$189.95</b>
<b>44944-08A</b>	Chrome.	<b>\$139.95</b>
<b>44942-08A</b>	Teardrop – Chrome & Raw.	<b>\$139.95</b>
<b>41500047</b>	Teardrop – Black & Polished.	<b>\$199.95</b>
<b>44940-08A</b>	ThunderStar.	<b>\$159.95</b>
<b>44947-08A</b>	Vivid Black.	<b>\$139.95</b>
<b>46778-09A</b>	Classic Black.	<b>\$139.95</b>
<b>41500058</b>	Gloss Black Polished.	<b>\$199.95</b>
<b>41500107</b>	Split 7 Spoke, Polished.	<b>\$189.95</b>
<b>41500108</b>	Split 7 Spoke, Black.	<b>\$189.95</b>

#### Front

Fits '00-'13 XL and XR, '00-'05 Dyna®, '00-'14 Softail (except Springer™) and '00-'07 Touring models.

<b>42155-07A</b>	Blade. Left Side.	<b>\$199.95</b>
<b>42156-07A</b>	Blade. Right Side.	<b>\$199.95</b>
<b>44360-00A</b>	Chrome.	<b>\$139.95</b>
<b>44821-00A</b>	Classic Chrome.	<b>\$139.95</b>
<b>44411-09A</b>	Reaper. Left Side.	<b>\$189.95</b>
<b>46640-07A</b>	Revolver.	<b>\$189.95</b>
<b>44700-03A</b>	Road Winder™. Left Side.	<b>\$189.95</b>
<b>44703-03A</b>	Road Winder. Right Side.	<b>\$189.95</b>
<b>45118-06A</b>	Slotted 6-Spoke.	<b>\$189.95</b>
<b>44367-00A</b>	Teardrop.	<b>\$139.95</b>
<b>44365-00A</b>	ThunderStar™.	<b>\$159.95</b>
<b>41500070</b>	Turbine.	<b>\$249.95</b>
<b>44358-00A</b>	Vivid Black.	<b>\$139.95</b>

#### Front

Fits all '84-'99 models. Front rotors must be installed with Brake Pad Kit P/N 44063-83C (sold separately).

<b>44101-95A</b>	Chrome.	<b>\$139.95</b>
<b>44100-95A</b>	Vivid Black.	<b>\$139.95</b>



Split 7 Spoke, Polished



Split 7 Spoke, Black



Blade



Chrome



Classic Black



Classic Chrome



Reaper



Revolver



Road Winder



Slotted 6-Spoke



### A. FLOATING BRAKE ROTORS

Notice: The prices appearing in this catalog are the manufacturer's suggested retail prices. Actual retail prices may vary.

# WHEELS 769

Brake Rotors

## A. FLOATING BRAKE ROTORS continued

### Rear

Fits '00-'10 XL, '00-later Dyna®, '00-later Softail® and '00-'07 Touring models. Separate purchase of Brake Rotor Hub Plate P/N 43837-00 is required when installing on FXSTD original equipment 17" wheels.

<b>41500109</b>	Split 7 Spoke, Polished.	<b>\$189.95</b>
<b>41500110</b>	Split 7 Spoke, Black.	<b>\$189.95</b>
<b>42158-07A</b>	Blade.	<b>\$199.95</b>
<b>44359-00A</b>	Chrome.	<b>\$139.95</b>
<b>46777-09A</b>	Classic Black.	<b>\$139.95</b>
<b>44822-00A</b>	Classic Chrome.	<b>\$139.95</b>
<b>44421-09A</b>	Reaper. Right Side.	<b>\$189.95</b>
<b>41500066</b>	Reaper – Black. Right Side.	<b>\$199.95</b>
<b>46641-07A</b>	Revolver.	<b>\$189.95</b>
<b>44706-03A</b>	Road Winder. Right Side.	<b>\$189.95</b>
<b>45047-06A</b>	Slotted 6-Spoke.	<b>\$189.95</b>
<b>44368-00A</b>	Teardrop.	<b>\$139.95</b>
<b>44366-00A</b>	ThunderStar.	<b>\$159.95</b>
<b>41500069</b>	Turbine.	<b>\$249.95</b>
<b>44357-00A</b>	Vivid Black.	<b>\$139.95</b>

### Rear

Fits '87-'99 XL, '87-'99 Dyna, '87-'94 FXR, '99 FXR2 and FXR3 and '87-'99 Softail models. Rear rotors must be installed with Brake Pad Kit P/N 44209-87C (sold separately).

<b>44108-95A</b>	Chrome.	<b>\$139.95</b>
<b>44102-95A</b>	Vivid Black.	<b>\$139.95</b>



Teardrop



Teardrop – Black



ThunderStar



Gloss Black Polished



Vivid Black



Reaper Gloss Black



Turbine



### Model Family Fitment:

<span style="display:inline-block; width:10px; height:10px; background-color:grey; border:1px solid black;"></span> V-ROD	<span style="display:inline-block; width:10px; height:10px; background-color:yellow; border:1px solid black;"></span> SPORTSTER	<span style="display:inline-block; width:10px; height:10px; background-color:red; border:1px solid black;"></span> DYNA
<span style="display:inline-block; width:10px; height:10px; background-color:purple; border:1px solid black;"></span> SOFTAIL	<span style="display:inline-block; width:10px; height:10px; background-color:teal; border:1px solid black;"></span> TOURING	

## A. FLOATING BRAKE ROTORS

Notice: The prices appearing in this catalog are the manufacturer's suggested retail prices. Actual retail prices may vary.



# 770 WHEELS

## Brake Rotors

### POLISHED BRAKE ROTORS

A perfect complement to stock or custom wheels. Manufactured to Original Equipment specifications for exact fit, these rotors are meticulously polished to achieve a chrome-like appearance. Rotors are sold individually and include chrome installation hardware.

- A. Fits '09-later Touring models (except FLHRC, FLHRSE and FLHTKSE) with Enforcer or Impeller wheels.  
**41500094** Front. **\$189.95**

---

- B. Fits '14-later XL, '06-later Dyna®, '15-later Softail® and '08-later Touring and Trike models with Original Equipment or accessory wheel with 3.25" bolt circle rotor mount.  
**41500106** Front. Left Side. **\$149.95**

---

- C. Fits '00-'13 XL and XR, '00-'14 Softail (except Springer™), '00-'07 Touring and '00-'05 Dyna models.  
**41830-05A** Front. Left Side. **\$149.95**  
**41831-05A** Front. Right Side. **\$149.95**

---

- D. Fits '08-'13 Touring and Trike models (except FLHRSE4, FLTRSE3, FLHXSE/2). Fits '14-later FLHRC. Fits selected accessories wheels with standard 5 hole hub-mount brake disc. Consult wheel I-sheet for details.  
**44950-08** Front. Left Side. **\$149.95**  
**44959-08** Front. Right Side. **\$149.95**

---

- E. Fits '06-later VRSC™ and Dyna models. Also Fits '08-later Touring and Trike models. Requires Original Equipment or Accessory wheel with 6.7" bolt circle rotor mount. Does not fit Enforcer or Impeller wheels.  
**41500012A** Front. **\$149.95**

---

- F. Fits '00-later Dyna and Softail models, '00-'10 XL models and '00-'07 Touring models. Separate purchase of Brake Rotor Hub Plate P/N 43837-00 is required when installing on FXSTD Original Equipment 17" wheels.  
**41832-05A** Rear. **\$149.95**

---

- G. Fits '11-later XL and '10-'13 XR models.  
**41500005** Rear. **\$149.95**



A. POLISHED BRAKE ROTOR – FRONT  
(41500094 SHOWN)



A. POLISHED BRAKE ROTOR – FRONT  
(41500094 SHOWN)



B. POLISHED BRAKE ROTOR – FRONT  
(41500106 SHOWN)



C. POLISHED BRAKE ROTOR – FRONT  
(41831-05A SHOWN)



D. POLISHED BRAKE ROTOR – FRONT  
(44950-08 SHOWN)



E. POLISHED BRAKE ROTOR – FRONT  
(41500012A SHOWN)



F. POLISHED BRAKE ROTOR – REAR  
(41832-05A SHOWN)



G. POLISHED BRAKE ROTOR – REAR  
(41500005 SHOWN)

#### Model Family Fitment:

- V-ROD
- SPORTSTER
- DYNA
- SOFTAIL
- TOURING

*Notice: The prices appearing in this catalog are the manufacturer's suggested retail prices. Actual retail prices may vary.*



**H. DECORATIVE WHEEL WEIGHTS – BAR & SHIELD**

**H. DECORATIVE WHEEL WEIGHTS – BAR & SHIELD**

Calibrate your wheel balance with a touch of class with these uniquely designed wheel weights. Adhesive backing for easy installation.

Fits Original Equipment and accessory wheel rims.

**95615-04** .5 oz. **\$2.95**

**I. BRAKE ROTOR HARDWARE KIT – CHROME**

It's the details, like this chrome hardware kit, that really get your bike noticed. This hardware adds a unique chrome-plated finish to the Original Equipment or accessory floating brake rotors. Kit includes 5 chrome-plated bolts manufactured to factory specifications to ensure fit and performance.

**91800029** Shoulder Bolt – Front. **\$29.95**

Fits '02-later models equipped with Open Brake Rotor P/N 44343-01, 44553-06A, 41500012A, 41500040 or 41500042.

**41500095** Button Head – Front. **\$39.95**

Fits '09-later Touring models equipped with Enforcer or Impeller Wheels.

**46646-05** Button Head – Front. **\$13.95**

Fits '90-later models (except VRSC™, '14-later Touring and Trike and models equipped with Open Brake Rotor P/N 44343-01, 44553-06A, 41500012, 41500040 or 41500042).

**46647-05** Button Head – Rear. **\$13.95**

Fits '92-later models (except Trike).

**J. SPROCKET HARDWARE – CHROME HEX HEAD**

This kit includes highly-polished, chrome-plated, grade 8 hex-head screws with chrome-plated washers, providing an extra custom accent. The perfect addition to the chrome sprocket. Made from the same Original Equipment bolts to ensure product integrity. Also works with chrome belt sprocket covers and Original Equipment sprockets.

**94773-07** **\$29.95**

Fits '07-later Dyna® and Softail® models.

**94773-00A** **\$29.95**

Fits '00-'06 Softail and '00-'05 Dyna models.

**94708-98** **\$29.95**

Fits '93-'99 Softail, '93-'99 Dyna and '91-later XL models.

**K. CHROME-PLATED ABS VALVE STEM CAPS**

A special chrome touch with special graphics. Will not seize on valve stems and includes O-rings for reliable seal. Sold in pairs.

Universal fitment. Also fits suspension air valves.

**1. 41146-97** Gold "H-D" Logo Outline on Black. **\$9.95**

**2. 41144-97** Color Bar & Shield Logo. **\$9.95**

**3. 41145-97** **\$9.95**

White Bar & Shield Logo Outline on Black.

**4. 41171-03** White Skull Logo on Black. **\$9.95**

**L. CHROME-PLATED BRASS VALVE STEM CAPS**

The beauty of chrome with the durability of machined brass, featuring a laser-etched Bar & Shield logo painted black. Available with a traditional, unique fluted or rugged acorn shaped cylinder. Will not seize on valve stems and includes O-rings for reliable seal. Sold in pairs.

Universal fitment. Also fits suspension air valves.

**1. 41149-98** **\$14.95**

Fluted Cylinder with Bar & Shield Logo.

**2. 41148-98** **\$14.95**

Acorn Nut with Bar & Shield Logo.

**3. 41150-98** **\$14.95**

Acorn Nut with Grooved Cylinder with Bar & Shield Logo.



**I. BRAKE ROTOR HARDWARE KIT – CHROME (91800029 SHOWN)**



**I. BRAKE ROTOR HARDWARE KIT – CHROME (41500095 SHOWN)**



**I. BRAKE ROTOR HARDWARE KIT – CHROME (46646-05 SHOWN)**



**J. SPROCKET HARDWARE – CHROME HEX HEAD**



**K. CHROME-PLATED ABS VALVE STEM CAPS**



**L. CHROME-PLATED BRASS VALVE STEM CAPS**

Notice: The prices appearing in this catalog are the manufacturer's suggested retail prices. Actual retail prices may vary.



GENUINE MOTOR PARTS &amp; ACCESSORIES



2015

## LUGGAGE

Pack it up and take it with you in style with a set of H-D® soft luggage. The complete collection of touring bags and compact storage pouches take the hassle out of long-distance planning by making packing decisions easier.



# PREMIUM TOURING LUGGAGE COLLECTION

Designed by riders, for riders. The Premium Luggage Collection features everything you ever wanted in a bag and more. Formed of superior heavy-weight ballistic nylon, these sturdy bags will maintain their shape and protect your belongings over the long haul and are tastefully styled to feel at home when carried into a nice hotel.



For a video view, log on to: [h-d.com/partsvideos](http://h-d.com/partsvideos)

### 3M™ SCOTCHLITE™ REFLECTIVE TRIM

Retroreflection technology enhances low-light and nighttime visibility by bouncing light directly back to the source.

### SECURE SPANDEX MOUNTING SYSTEM

Smooth band slips over the passenger backrest for a snug fit, eliminating the belts and fasteners that poke you in the back.

### UV-RESISTANT FINISH

Coated to fight the sun's harshest rays and maintain the rich black color.

**2-YEAR**  
HARLEY-DAVIDSON®  
WARRANTY

### DURABLE BALLISTIC NYLON CONSTRUCTION

Heavy-weight formed ballistic nylon helps bag retain its shape.



### QUICK-RELEASE MOUNTING STRAPS

Convenient straps simplify installation and removal and provide a secure no-shift fit.



### INTERLOCKING D-RINGS

Multipurpose D-Rings simplify attachment of other luggage, bungee cords or cargo nets.



### OVERSIZE HANDLES

Soft-touch ergonomic handle is shaped for effortless transport to and from the bike.



### GLOVE-FRIENDLY ZIPPER PULLS

Large ergonomic-contoured pulls are easy to grip for quick on-the-go access.



### INTEGRATED RAIN COVER

Ripstop nylon cover is coated to shed water and features 3M™ Scotchlite™ reflective trim for added visibility.



# LUGGAGE 775

Touring Luggage

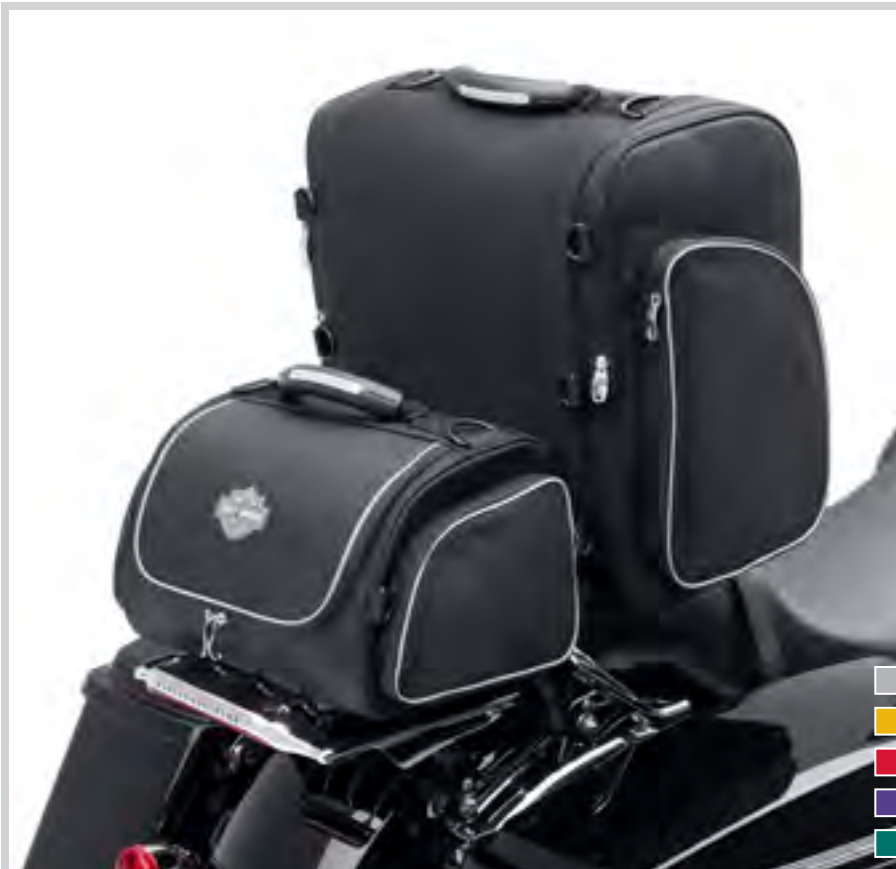

**A. TOURING LUGGAGE SYSTEM**

## A. TOURING LUGGAGE SYSTEM

This two-bag system features both a large Touring Bag and an exclusive compact Day Bag. The Touring Bag is ideal for a long weekend trip, but expands an additional 4.0" when you need to store a few extras. The Day Bag is perfect for the daily work commute and can be stored inside of the Touring Bag when not in use. The bags can be used together or separately to match your storage needs. The bags feature an innovative spandex mounting pocket that makes installation and removal a simple process. Just slip the smooth, low-profile band over the passenger backrest for a snug and secure fit and cinch the bag in place with the adjustable mounting straps. The spandex material reverts back to its original shape when the bag is removed for a first-class look when you are checking in to the hotel. Bag and integrated rain cover feature 3M™ Scotchlite™ reflective piping and graphics for added visibility. Luggage features a two-year Harley-Davidson® warranty. See your Dealer for details.

For additional versatility, these bags can be equipped with an optional Clip-On Rider Backrest for long haul comfort and a Premium Shoulder Strap for easy handling. Touring Bag features 3 zippered exterior pockets and 1 zippered mesh interior pocket. Day Bag features 2 exterior pockets and 1 zippered mesh interior pocket. Touring Bag Dimensions: 15.5" W x 10.0" D x 17.0" T (unexpanded); 20.0" W x 10.0" D x 17.0" T (expanded). Luggage capacity: 2400 cubic inches (unexpanded) and 3000 cubic inches (expanded). Day Bag Dimensions: 13.0" W x 10.0" D x 9.0" T. Luggage capacity: 900 cubic inches.

**93300003** **\$299.95**

Installation requires a sissy bar upright, backrest pad and luggage rack (if not mounting luggage on passenger pillion). Does not fit with oversized backrest pad.

## B. TOURING BAG

The Touring Bag is ideal for a long weekend trip, but expands an additional 4.0" when you need to store a few extras. The bag features large exterior pockets with glove-friendly, ergonomically contoured zipper pulls and an oversize custom handle. The innovative spandex mounting pocket makes installation and removal a simple process. Just slip the smooth, low-profile band over the passenger backrest for a snug and secure fit and cinch the bag in place with the adjustable mounting straps. The spandex material reverts back to its original shape when the bag is removed for a first-class look when you are checking in to the hotel. Bag and integrated rain cover feature 3M Scotchlite reflective piping and graphics for added visibility. Luggage features a two-year Harley-Davidson warranty. See your Dealer for details.

For additional versatility, these bags can be equipped with an optional Clip-On Rider Backrest for long haul comfort and a Premium Shoulder Strap for easy handling. Touring Bag features 3 zippered exterior pockets and 1 zippered mesh interior pocket. Dimensions: 15.5" W x 10.0" D x 17.0" T (unexpanded); 20.0" W x 10.0" D x 17.0" T (expanded). Luggage capacity: 2400 cubic inches (unexpanded) and 3000 cubic inches (expanded).

**93300004** **\$229.95**

Installation requires a sissy bar upright, backrest pad and luggage rack (if not mounting luggage on passenger pillion). Does not fit with oversized backrest pad.



**B. TOURING BAG**

### Model Family Fitment:

- V-ROD
- SPORTSTER
- DYNA
- SOFTAIL
- TOURING

*Notice: The prices appearing in this catalog are the manufacturer's suggested retail prices. Actual retail prices may vary.*

# 776 LUGGAGE

## Touring Luggage

### A. ROLLING TOURING BAG

The Rolling Touring Bag is our largest bag and is ideal for a cross-country trip. Equipped with smooth rolling sealed ball-bearing wheels and a locking push-button 2-stop extension handle, this bag is easy to move from the bike to the hotel. The Rolling Bag features large exterior pockets with glove-friendly, ergonomically contoured zipper pulls and an over-size custom handle. The innovative spandex mounting pocket makes installation and removal a simple process. Just slip the smooth, low-profile band over the passenger backrest for a snug and secure fit and cinch the bag in place with the adjustable mounting straps. The spandex material reverts back to its original shape when the bag is removed for a first-class look when you are checking in to the hotel. Bag and integrated rain cover feature 3M™ Scotchlite™ reflective piping and graphics for added visibility. Luggage features a two-year Harley-Davidson® warranty. See your Dealer for details.

For additional versatility, these bags can be equipped with an optional Clip-On Rider Backrest for long haul comfort and a Premium Shoulder Strap for easy handling. Rolling Bag features 2 zippered exterior side pockets, 1 zippered front pouch with mesh pocket and a large interior space with 1 zippered mesh pocket. Dimensions: 18.5" W x 10.5" D x 18.0" T. Luggage capacity: 3100 cubic inches.

**93300008** **\$259.95**

Installation requires a sissy bar upright, backrest pad and luggage rack (if not mounting luggage on passenger pillion). Does not fit with oversized backrest pad.

### B. OVERNIGHT BAG

The Overnight Bag is ideal for the shorter trip and conveniently mounts to either your Tour-Pak® luggage rack or Sissy Bar Upright. The bag features large exterior pockets with glove-friendly, ergonomically contoured zipper pulls and an over-size custom handle. The innovative spandex mounting pocket makes installation and removal a simple process. Just slip the smooth, low-profile band over the passenger backrest for a snug and secure fit and cinch the bag in place with the adjustable mounting straps. The spandex material reverts back to its original shape when the bag is removed for a first-class look when you are checking in to the hotel. Bag and integrated rain cover feature 3M Scotchlite reflective piping and graphics for added visibility. Luggage features a two-year Harley-Davidson warranty. See your Dealer for details.

For additional versatility, these bags can be equipped with an optional Clip-On Rider Backrest for long haul comfort and a Premium Shoulder Strap for easy handling. Overnight Bag features 2 zippered exterior pockets and 1 zippered mesh interior pocket. Dimensions: 16.5" W x 12.0" D x 11.0" T. Luggage capacity: 1700 cubic inches.

**93300005** **\$149.95**

Installation requires a sissy bar upright, backrest pad and luggage rack (if not mounting luggage on passenger pillion). Does not fit with oversized backrest pad. Also fits models equipped with Tour-Pak, Trike or Sidecar Luggage Racks (except Mini Rack P/N 53100-96).

### C. DAY BAG

The compact Day Bag is perfect for the daily work commute. The innovative spandex mounting pocket makes installation and removal a simple process. Just slip the smooth, low-profile band over the passenger backrest for a snug and secure fit and cinch the bag in place with the adjustable mounting straps. The spandex material reverts back to its original shape when the bag is removed for a first-class look when you are checking in to the hotel. Bag and integrated rain cover feature 3M Scotchlite reflective piping and graphics for added visibility. Luggage features a two-year Harley-Davidson warranty. See your Dealer for details.

For additional versatility, these bags can be equipped with a Premium Shoulder Strap for easy handling. Day Bag features 2 exterior pockets and 1 zippered mesh interior pocket. Day Bag Dimensions: 13.0" W x 10.0" D x 9.0" T. Luggage capacity: 900 cubic inches.

**93300017** **\$99.95**

Installation requires a sissy bar upright, backrest pad and luggage rack (if not mounting luggage on passenger pillion). Does not fit with oversized backrest pad.



A. ROLLING TOURING BAG



B. OVERNIGHT BAG



C. DAY BAG

Notice: The prices appearing in this catalog are the manufacturer's suggested retail prices. Actual retail prices may vary.





**D. TAIL BAG**

### D. TAIL BAG

This Tail Bag is the perfect addition for your daily commute or a run to the sunset. The bag rests on the passenger pillion and is secured in position with adjustable quick-release straps. The surprisingly roomy bag features 2 exterior side pockets and a large top-opening for access to the interior. The UV-resistant ballistic nylon surface covers the built-in reinforced tub that helps the bag maintain its shape – even when empty. The bag features 3M™ Scotchlite™ reflective trim for added visibility and an integrated rain cover for protection from the elements. The oversize custom handle simplifies transport to and from the motorcycle. Luggage features a two-year Harley-Davidson® warranty. See your Dealer for details.

For additional versatility, these bags can be equipped with an optional Clip-On Rider Backrest for long haul comfort and a Premium Shoulder Strap for easy handling. Overnight Bag features 2 zippered exterior pockets and mesh interior pockets. Dimensions: 16.0" W x 16.0" D x 10.0" T. Luggage capacity: 1250 cubic inches.

**93300069A**

**\$169.95**

Fits passenger pillion on most models.



### E. TOUR-PAK® RACK BAG

The Tour-Pak® Rack Bag is perfect for one night or a quick weekend getaway and conveniently mounts to your Tour-Pak luggage rack. The built-in plastic reinforced tub and the UV-resistant, formed, 1680-denier ballistic nylon upper will maintain its sturdy shape and protect your belongings for the long haul. The bag features large exterior pockets with glove-friendly, ergonomically contoured zipper pulls and an oversize custom handle. Bag and integrated rain cover feature 3M Scotchlite reflective piping and graphics for added visibility. Luggage features a two-year Harley-Davidson warranty. See your Dealer for details.

For additional versatility, these bags can be equipped with an optional Premium Shoulder Strap for easy handling. Tour-Pak Rack Bag features 2 zippered exterior side pockets, 1 zippered top pocket and 3 zippered mesh interior pockets. Dimensions: 20.5" W x 13.0" D x 9.5" T. Luggage capacity: 2000 cubic inches.

**93300006**

**\$199.95**

Fits models equipped with Tour-Pak, Trike or Sidecar Luggage Racks (except Mini Rack P/N 53100-96).



**E. TOUR-PAK RACK BAG**

### F. COLLAPSIBLE RACK BAG

The Collapsible Rack Bag is the ideal "just in case" storage solution. Made from 1680 denier ballistic nylon, the bag folds flat to fit inside your Tour-Pak when not in use. When ready, this large soft-sided bag is easy to pack and can be expanded when the need for more storage arises. The bag features an easy-access exterior pocket with glove-friendly zipper pulls. The Collapsible Rack Bag mounts to the Tour-Pak Rack with adjustable quick-release straps and includes a basic shoulder strap. Bag and integrated rain cover feature 3M Scotchlite reflective piping and graphics for added visibility. Luggage features a two-year Harley-Davidson warranty. See your Dealer for details. Dimensions: 20.0" W x 12.0" D x 12.0" T. Luggage capacity: 2700 cubic inches.

**93300009**

**\$99.95**

Fits models equipped with Tour-Pak, Trike or Sidecar Luggage Racks (except Mini Rack P/N 53100-96).



**F. COLLAPSIBLE RACK BAG**

#### Model Family Fitment:

- V-ROD
- SPORTSTER
- DYNA
- SOFTAIL
- TOURING

*Notice: The prices appearing in this catalog are the manufacturer's suggested retail prices. Actual retail prices may vary.*

## 778 LUGGAGE

### Touring Luggage

#### A. SISSY BAR BACKPACK

This attractive backpack is shaped to provide convenient storage on your way to work. The heavy-duty hook-and-loop flaps secure the bag to the sissy bar for one-step installation. And when you get to work, this bag features traditional backpack straps that allow you to carry your bag in hands-free comfort. The bag features plenty of smart storage spaces with glove-friendly, ergonomically contoured zipper pulls. Backpack features 2 zippered exterior pockets, 2 exterior mesh water bottle pockets, personal music device pocket with headphone port, a padded laptop compartment and a large interior space. Bag and integrated rain cover feature 3M™ Scotchlite™ reflective piping and graphics for added visibility. Luggage features a two-year Harley-Davidson® warranty. See your Dealer for details. Dimensions: 14.0" W x 13.0" D x 18.5" T. Luggage capacity: 1600 cubic inches.

**93300007** **\$149.95**

Installation requires a sissy bar upright, backrest pad and luggage rack (if not mounting luggage on passenger pillion). Does not fit with oversized backrest pad.



A. SISSY BAR BACKPACK



B. PREMIUM RIDER BACKREST PAD

#### B. PREMIUM RIDER BACKREST PAD

Snap on some comfort. Designed to provide a little extra support on a long trip, this 10.0" x 7.0" Backrest Pad attaches to the Premium Touring Bag, Overnight Bag or Rolling Touring Bag with 4 simple-to-install clips. Just strap the bag to the passenger pillion, clip the pad to the Premium Luggage Bag D-rings and sit back and relax.

**93300010** **\$29.95**

For use with Premium Luggage Collection Touring Bag, Overnight Bag and Rolling Touring Bag.

#### C. PREMIUM SHOULDER STRAP

Carry your bag in comfort. This stylish Premium Shoulder Strap features a large cushioned pad that spreads the weight and eases the pressure on your shoulder. The strap clips to most Premium Luggage Collection bags and extends to 61.0" to place the bag at the ideal carrying position. The strap conveniently hides in the outside pocket of your bag and quickly snaps into place when you carry the bag into the hotel.

**93300014** **\$14.95**

For use with Premium Luggage Collection Bags (except Sissy Bar Backpack P/N 93300007).



C. PREMIUM SHOULDER STRAP



D. AUXILIARY STRAP KIT

#### D. AUXILIARY STRAP KIT

Ideal for use when luggage is mounted on a narrow passenger pillion, or when you need to secure multiple pieces of luggage for a long trip. This Auxiliary Strap Kit features two 34.0" adjustable straps that clip onto the luggage D-rings to provide additional mounting support.

**93300015** **\$14.95**

For use with Premium Luggage Collection Bags.

#### E. TANK BAG

Shaped to fit the contour of the fuel tank, this ballistic nylon UV- and weather resistant tank bag is your perfect traveling companion. The bag features a clear top pouch for at-a-glance viewing of maps and directions. The rigid body retains its shape – even when empty – and the full-length dual-zippered opening provides easy access. The interior features (2) zippered mesh pouches, (1) quick access nylon pouch and large center cavity for storage of larger items. The internal top pouch adds (3) additional storage slots and (3) pen/pencil holders. Headphone port lets you to “plug in” while keeping your device protected inside the bag. Tank Bag features integrated rain cover with reflective striping. Integrated magnets and soft bottom keep the bag secure to tank while preventing scratches to paint. Quick-release clips allow the bag to be removed for easy access to the fuel filler and the comfortable carrying handle makes transportation a breeze.

**93300040** **\$139.95**

Fits '04-later XL models.



E. TANK BAG

Notice: The prices appearing in this catalog are the manufacturer's suggested retail prices. Actual retail prices may vary.



# LUGGAGE 779

Sissy Bar & Rack Bags



**F. RIDER BRIEFCASE**



## F. RIDER BRIEFCASE

Commute to work in style. Leather and vinyl briefcase is designed with the rider in mind and is sized to fit effortlessly into hard saddlebags on Touring models. The oversized handle and the non-slip shoulder strap are comfortable to carry and glove-friendly zippers and are easy to operate. The large messenger-style flap is secured with quick-release snaps concealed behind the traditional straps and buckles. When open, the interior reveals a zippered front storage pouch that features a key ring holder, secure cellphone pocket, a PDA accessory pocket, pen loops, interior zippered pocket and card holders. The main compartment features a padded laptop and tablet pocket and open storage for files and documents. Snap close side ports allow headphone and charger cable access. Size: 16.5" x 11.5" x 5.0", fits laptops up to 15.0" x 10.0" (accommodates most 17.0" screens).

**93300092 \$249.95**  
Sized to fit Touring models equipped with Color-Matched Saddlebags.

## G. MESSENGER BAG SISSY BAR LUGGAGE

Tapered "messenger" style bag easily mounts to the sissy bar and adds needed storage space to your custom ride. The heavy leather lid with embossed Bar & Shield logo features a traditional strap and buckle look, but conceals quick-disconnect clips for easier access. The rigid back shell helps the bag maintain its shape and the built-in water-resistant polyester liner with drawstring closure keeps items dry inside. Dimensions: 10.0" W x 12.0" T x 9.5" D. Luggage capacity: 925 cubic inches. Installation requires a sissy bar upright, backrest pad and Bobtail Luggage Rack.

**94792-08 \$169.95**  
Fits most Harley-Davidson® models equipped with passenger backrest and luggage rack. Does not fit Mini or Short Uprights or uprights with bucket or oversized backrest pads.

## H. HERITAGE LEATHER TOURING BAG

Styled to match Heritage Softail® Classic models, this bag features chrome spots, buckles and heavy-duty wide leather straps. With quick-disconnect clips for easy removal and 720 cubic inches of storage space, this bag is as convenient as it is cavernous.

**98864-97 \$329.95**  
Fits Softail models equipped with Luggage Rack P/N 53465-87B, 56465-86A or 53713-96.

## I. LEATHER SISSY BAR BAGS

This Sissy Bar Bag is an easy way to add extra storage. High-quality molded-leather construction holds its shape and is a convenient place to store quick-access items. Features a turn-buckle closure for a snug fit.

Fits most Harley-Davidson Medallion/Insert Style Sissy Bar Uprights, Luggage Racks and Pad. Will not fit with Short Uprights, One-Piece Uprights or sissy bars for VRSC™, XG, XR, FXSTD, Touring and Trike models. Will not fit with backrest-pad mounted luggage.

**52997-98 \$99.95** Bar & Shield Logo Concho.  
**52998-98 \$99.95** Chrome Studs.



**G. MESSENGER BAG SISSY BAR LUGGAGE**



**H. HERITAGE LEATHER TOURING BAG**



**I. LEATHER SISSY BAR BAG – BAR & SHIELD LOGO CONCHO**



**I. LEATHER SISSY BAR BAG – CHROME STUDS**

### Model Family Fitment:

V-ROD   
  SPORTSTER   
  DYNA  
 SOFTAIL   
  TOURING

Notice: The prices appearing in this catalog are the manufacturer's suggested retail prices. Actual retail prices may vary.

# 780 LUGGAGE

## Shrink Sacks

### A. SHRINK SACKS

Shrink Sacks provide the ultimate in cargo convenience by collapsing bulky clothing down to a fraction of its original size. Simply load the bag, seal it, roll it to evacuate the air and store your soft goods in a fraction of the space that used to fill your Tour-Pak® luggage, Saddlebag or Premium Luggage bag. Designed to handle several weeks on the road, Shrink Sacks are the perfect companion for each and every trip you have planned. Each kit includes 3 bags.

**90200719** Medium. **\$17.95**

Fits Saddlebags, Premium Luggage and Tour-Pak luggage.

**90200721** Large. **\$19.95**

Fits Tour-Pak luggage, Tour-Pak Rack Bags and Touring Bags.



A. TOUR-PAK CONTENTS – BEFORE



A. CONTENTS PACKED IN 3 LARGE SHRINK SACKS



#### Model Family Fitment:

- V-ROD
  SPORTSTER
  DYNA
- SOFTAIL
  TOURING

A. SHRINK SACK CAPACITY

*Notice: The prices appearing in this catalog are the manufacturer's suggested retail prices. Actual retail prices may vary.*



# LUGGAGE 781

Luggage Accessories



**B. BOOM! AUDIO MUSIC PLAYER TANK POUCH**

**B. BOOM!™ AUDIO MUSIC PLAYER TANK POUCH**

This portable music system pouch is designed for motorcycle use. The neoprene jacket offers hard-core protection for your portable music device, while the built-in magnets hold the pouch securely to the fuel tank. The clear play-through window permits touch-screen control and the anti-skid interior allows the pouch to accommodate players of various sizes. The clamshell design makes inserting your player into the pouch quick and easy and the double zipper allows for headphone and output cables to exit the pouch at any point on top, bottom or one side of the pouch. Simply plug in your headphones or connect your in-dash Advanced Audio Radio with an auxiliary cable or Boom!™ Audio iPod® Interface and enjoy your music collection. Works well with many MP3 and other personal music players, but should not be used with hard-disk memory players. Window measurement: 2.25" W x 4.0" H.

**76000193 \$44.95**

Fits models with steel fuel tanks or airbox covers.



**C. MAGNETIC TANK TOTE**

**C. MAGNETIC TANK TOTE**

De-clutter your pockets. This compact and convenient magnetic pouch is the ideal place to store small items that would normally go in your jeans pocket. It's also the perfect way to enjoy the benefits of SiriusXM® Satellite Radio, NavWeather® and NavTraffic® on your non-fairing equipped motorcycle. Just slip the Road Tech™ zūmo® SiriusXM disc antenna into this pouch and the strong magnets will secure it to the top of the fuel tank, yet make it easy to move your Road Tech zūmo from the bike to the car. The durable neoprene jacket with zippered closure will keep your items safe for the ride. An embroidered Bar & Shield logo finishes the look. Pouch dimensions: 4.0" W x 5.5" H.

**76000061 \$34.95**

Fits models with steel fuel tanks or airbox covers.



**D. FRAME BAG**

**D. FRAME BAG**

Great for small items like cell phones and sunglasses, this compact bag tucks neatly in the left side of the frame for a clean look.

**94204-03A \$34.95**

Fits '02-later VRSC™ models (except VRSCR).

**E. CD HOLDER**

A great accessory for your in-dash CD or Tour-Pak® mounted CD changer. This convenient CD case holds up to 12 CDs

**58481-02 \$9.95**

**F. DOCUMENT HOLDER**

This Document Holder provides a convenient storage space under the VRSC hinged seat or in saddlebags. The clear zip-closure pouch attaches to the underside of the seat or to the interior of a saddlebag with convenient hook-and-loop strips and the pouch can be removed and replaced with a simple lift and pull.

**94206-03 \$10.95**

Fits '02-later VRSC models (except VRSCR). Also fits inside saddlebags.



**F. DOCUMENT HOLDER**

LUGGAGE

Notice: The prices appearing in this catalog are the manufacturer's suggested retail prices. Actual retail prices may vary.

# 782 LUGGAGE

## Swingarm Saddlebags

### A. SINGLE-SIDED SWINGARM BAG

Less is more. With enough room for the essentials, these stylish Swingarm Bags eliminate the need to stuff your pockets or bungee a bag across the passenger pillion. Shaped to hug the contour of your bike's frame, these compact bags add an old-school look. Bags are constructed of heavyweight leather and feature a pouch-style flap lid that is secured with two quick-disconnect clips that are hidden behind traditional straps and buckles. The semi rigid-backed bag is secured to the left side of the bike with easy-to-install brackets and adjustable straps.

Fits '04-later XL models equipped with solo seats. Requires removal of passenger pegs. XL1200T models require removal of Original Equipment saddlebags and passenger pegs. Luggage capacity: 430 cubic inches total.

**90200572** Black Leather. **\$199.95**

**90200573** Brown Distressed Leather. **\$199.95**

Fits '06-later Dyna® models (except FLD) equipped with Solo Seats. Requires removal of passenger pegs. Luggage capacity: 265 cubic inches total.

**90200570** Black Leather. **\$179.95**

**90200571** Brown Distressed Leather. **\$179.95**

Fits '00-later Softail® models (except FXCW, FXCWC, FLSTC, FLSTNSE and FLSTSE models). Does not fit models equipped with rear axle covers, left hand tool box, passenger footboards, chrome swingarm covers or saddlebag guards. Luggage capacity: 400 cubic inches total.

**90200417** Black Smooth Leather. **\$199.95**

**90200456** Brown Distressed Leather. **\$199.95**

### B. FORK BAG – SOFTAIL® ROCKER™

Add a touch of leather up front with this functional Fork Bag. Styled to complement the Softail Rocker™ model's fuel tank badge and accessory saddlebags, the embossed Bar & Shield logo makes a simple statement. The durable mounting bracket helps keep the bag in place and the heavyweight leather will last for years to come.

**92352-08** **\$84.95**

Fits '08-later FXCW and FXCWC models.



**A. SINGLE-SIDED SWINGARM BAG – SPORTSTER BLACK LEATHER**



**A. SINGLE-SIDED SWINGARM BAG – SPORTSTER BROWN DISTRESSED LEATHER**



**A. SINGLE-SIDED SWINGARM BAG – DYNA BLACK LEATHER**



**A. SINGLE-SIDED SWINGARM BAG – DYNA BROWN DISTRESSED LEATHER**



**A. SINGLE-SIDED SWINGARM BAG – SOFTAIL BLACK LEATHER**



**A. SINGLE-SIDED SWINGARM BAG – SOFTAIL BROWN DISTRESSED LEATHER**



**B. FORK BAG – SOFTAIL ROCKER**



#### Model Family Fitment:

- V-ROD
- SPORTSTER
- DYNA
- SOFTAIL
- TOURING

*Notice: The prices appearing in this catalog are the manufacturer's suggested retail prices. Actual retail prices may vary.*



# LUGGAGE 783

Frame & Sissy Bar Bags



C. DOWN TUBE BAG – BLACK LEATHER



C. DOWN TUBE BAG – BROWN DISTRESSED LEATHER



D. HANDLEBAR/FORK BAGS



E. SOFT LEATHER HANDLEBAR/FORK BAG



F. LEATHER SISSY BAR/TOOL BAG



G. LEATHER SISSY BAR BAG

## C. DOWN TUBE BAG

The perfect place to store a couple of tools, a tire gauge or your disc lock. The rigid-backed bag features a stylish heavy leather flap and traditional strap-and-buckle closures to provide both function and flair. Easy to install, the low frame placement is inconspicuous, but still provides quick access when needed. Kit includes all required mounting hardware.

Fits '04-later XL, XR and '06-later Dyna® models (except FLD). Does not fit XL models with engine guard. Does not fit XL models with Boom!™ Audio Cruiser Amp and Speaker Kit P/N 76262-08 or 76320-08. Does not fit Dyna models with evaporative emissions canister (California and AP markets). Does not fit with Dyna Oil Cooler Kit P/N 26151-07. Does not fit XL and Dyna models equipped with Front Spoilers. FXDFSE/2 and FXDFSE/2 models require removal of Original Equipment front spoiler.

<b>93300044</b>	Black Leather.	<b>\$129.95</b>
<b>93300045</b>	Brown Distressed Leather.	<b>\$129.95</b>

## D. HANDLEBAR/FORK BAGS

Constructed of durable synthetic leather with embossed "H-D Eagle Wing" logo. Looks great on sissy bar uprights, handlebars and front forks.

If used in front fork application, fits '84-later FLSTC Softail® and '93-later FXDWG Dyna models. '82-'89 FXR models require Directional Relocation Kit P/N 90504-82A.

<b>91743-87T</b>	11-inch length.	<b>\$29.95</b>
<b>91744-87T</b>	8-inch length.	<b>\$29.95</b>

## E. SOFT LEATHER HANDLEBAR/FORK BAG

Features include embroidered logos, full-length hook-and-loop closure over zipper and plush nylon pile inside lining. Features silver "Harley-Davidson" logo.

**91773-85**  
If used in front fork application, fits '84-later FLSTC Softail and '93-later FXDWG Dyna models. '82-'89 FXR models require Directional Relocation Kit P/N 90504-82A.

## F. LEATHER SISSY BAR/TOOL BAG

Heavy full-grain Latigo leather is specially tanned, oiled and waxed to withstand the elements. Identified with a custom Harley-Davidson® concho. 4.0" W x 4.0" D x 11.0" T.

**91772-85A** **\$99.95**  
For use with FXDWG (except '10-later FXDWG with Original Equipment Sissy Bar) and FXSTC models only.

## G. LEATHER SISSY BAR BAG

Manufactured of durable full-grain Latigo leather and decorated with bright, chrome-plated studs.

**91051-94** Studed. **\$109.95**

LUGGAGE

Notice: The prices appearing in this catalog are the manufacturer's suggested retail prices. Actual retail prices may vary.

# 784 LUGGAGE

## Windshield Bags

### A. THREE-POCKET WINDSHIELD POUCH

Add convenient storage space up front where you need it. This easy-to-install windshield pouch features three easily accessible storage pockets sized for cell phones, glasses and other small items. The center sized pouch is accented with an embossed "Harley-Davidson" script for a finishing touch.

**58904-03** **\$109.95**

Fits King-Size (except Springer™ and Rigid-Mount King Size) and Road King® windshields (except Wind Deflector and Adjustable Height).

### B. TWO-POCKET WINDSHIELD POUCH

Add convenient storage space up front where you need it. This easy-to-install windshield pouch features two easily accessible storage pockets sized for cell phones, glasses and other small items. Hook-and-loop closures allow easy one-handed opening. Both pouches are accented with an embossed "Harley-Davidson" logo for a finishing touch.

**57203-07** **\$109.95**

Fits King-Size or Compact windshields. Does not fit FLSTSB, FXDWG or FXSTD models. Does not fit Rigid-Mount, Super Sport, Nostalgic or Flamed windshields.

### C. DETACHABLE HANDBAG FOR WINDSHIELDS

Combine the on-bike storage of a windshield bag with the take-along convenience of a handbag. Constructed of leather and nylon, this durable and spacious bag features a zippered inside pocket for cell phones, cameras, wallets or sunglasses. The convenient mounting system allows easy attachment to the windshield and the quick-detach buckle lets you take it with you when you leave your bike. The purse-length leather shoulder strap and the smooth leather flap with embossed Bar & Shield logo offer the styling flexibility to complement any Harley-Davidson® motorcycle or MotorClothes® fashion design. Maximum capacity 2.5 lbs.

**58402-04** **\$79.95**

Fits King-Size (except Nostalgic, Flame and Skull with Wings King-Size) and Compact windshields (except FXSTD, Flame and Skull with Wings). Does not fit 100th Anniversary logo windshields, models equipped with handlebar mount gauges or Road Tech™ Riser Mount Radio.



A. THREE-POCKET WINDSHIELD POUCH



B. TWO-POCKET WINDSHIELD POUCH

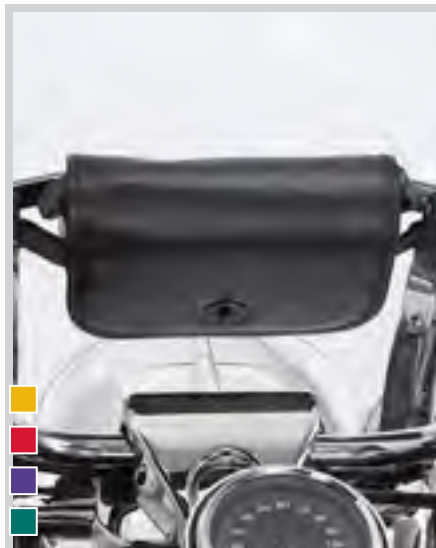

C. DETACHABLE HANDBAG FOR WINDSHIELDS

#### Model Family Fitment:

- V-ROD
- SPORTSTER
- DYNA
- SOFTAIL
- TOURING

*Notice: The prices appearing in this catalog are the manufacturer's suggested retail prices. Actual retail prices may vary.*



# LUGGAGE 785

## Windshield Bags



**D. DIAMOND ICE LEATHER WINDSHIELD BAG**



**E. FAT BOY WINDSHIELD BAG WITH DIE-CAST CONCHO**



**F. WINDSHIELD BAG FOR FAT BOY MODELS**



**G. WINDSHIELD BAG FOR SOFTAIL DELUXE MODELS**



**H. LEATHER WINDSHIELD BAG WITH BAR & SHIELD LOGO**



**I. ROAD KING LEATHER WINDSHIELD BAG**



**J. EMBOSSED BAR & SHIELD LOGO LEATHER WINDSHIELD BAG**



**K. ROAD KING CLASSIC LEATHER WINDSHIELD BAG**

### WINDSHIELD BAGS

Convenient storage space at your fingertips. Ideal for storing cell phones, sunglasses and other small items, these easy to install bags are available in a wide variety of styles to suit your customizing direction.

Fits King-Size and Compact windshields (except FXSTD, Flame and Skull with Wings). Does not fit 100th Anniversary logo windshields, models equipped with handlebar mount gauges or Road Tech™ Riser Mount Radio.

#### D. DIAMOND ICE LEATHER WINDSHIELD BAG

Designed to complement the H-D® Diamond Ice collection, the sturdy pouch is wrapped in supple leather for a premium look and feel. Magnetic closures keep your items safe.

**93300055** **\$129.95**

#### E. FAT BOY® WINDSHIELD BAG WITH DIE-CAST CONCHO

With a '00-'06 style "Fat Boy" logo concho and a leather laced lid, this bag provides classic Fat Boy styling.

**56626-99** **\$99.95**

#### F. WINDSHIELD BAG FOR FAT BOY MODELS

Highly stylized with a leather embossed lid, this bag features decorative chrome spots, Spanish lacing and a hook-and-loop closure.

**57216-07A** **\$109.95**

#### G. WINDSHIELD BAG FOR SOFTAIL® DELUXE MODELS

This leather bag features an embossed winged Bar & Shield logo and weave pattern insert. Bag includes turnbuckle closure.

**57207-05A** **\$109.95**

#### H. LEATHER WINDSHIELD BAG WITH BAR & SHIELD LOGO

Bag is accented with decorative chrome studs and an embossed Bar & Shield logo.

**58298-87** **\$99.95**

#### I. ROAD KING® LEATHER WINDSHIELD BAG

Bag is accented with decorative black studs and an embroidered Road King V-Logo.

**58297-94** **\$99.95**

#### J. EMBOSSED BAR & SHIELD LOGO LEATHER WINDSHIELD BAG

Black domestic steer hide bag features an embossed Bar & Shield logo.

**58308-95** **\$94.95**

#### K. ROAD KING CLASSIC LEATHER WINDSHIELD BAG

Leather bag features textured leather insert, H-D concho and a turnbuckle closure.

**58189-98** **\$109.95**

# 786 LUGGAGE

Fairing & Windshield Bags

## A. THREE-POCKET FAIRING POUCH – '14-LATER MODELS

Convenient storage space at your fingertips. Designed to complement H-D® wind deflectors and windshields, this fairing pouch is ideal for storing mobile devices, sunglasses and other small items. The sturdy plastic pouches are wrapped in supple UV-resistant vinyl for a premium look and feel and the magnetic closures keep your items within reach without detracting from the tastefully smooth styling.

**93300054A** **\$129.95**

Fits '14-later Electra Glide®, Street Glide® and Tri Glide® models with Windshields. Not for use with Wind Splitter Windshields P/N 57400204 or 57400205, H-D® Detachables™ Two-Up Tour-Pak® Mounting Rack or any H-D Detachables Two-Up Luggage Rack.



A. THREE-POCKET FAIRING POUCH – '14-LATER MODELS

## B. THREE-POCKET FAIRING POUCH – '96-'13 MODELS

Convenient storage space at your fingertips. Designed to complement H-D wind deflectors and windshields, this fairing pouch is ideal for storing cell phones, sunglasses and other small items. The sturdy plastic pouches are wrapped in supple UV-resistant vinyl for a premium look and feel and the magnetic closures keep your items within reach, while not detracting from the tastefully smooth styling. The left-hand pouch can be easily removed to accommodate your fairing-mounted GPS unit. Attractive "Harley-Davidson" script is featured on the front center pouch and also on the outboard side, visible through the windshield.

**58900-11** **\$114.95**

Fits '96-'13 Electra-Glide, Street Glide and Trike models. Not for use with Fairing Dash Pads. Models equipped with Illuminated Windshield Molding P/N 57335-08 requires separate purchase of Screws P/N 4456 (qty 3), Bar & Shield Windshield Molding P/N 59133-99 requires separate purchase of Screws P/N 94386-92T (qty 3), Chrome Windshield Molding P/N 59213-96 requires separate purchase of Screws P/N 94397-91T (qty 3).



B. THREE-POCKET FAIRING POUCH – '96-'13 MODELS

## C. LEATHER FAIRING POUCH

Easily installed inner fairing pouch is designed to hold sunglasses, cell phones, or riding gloves. All-leather construction around a molded ABS plastic base for shape retention. Has an easy-to-use full-length hook-and-loop closure and features a black embroidered Bar & Shield logo on the lid.

**58248-96** **\$109.95**

Fits '96-'13 Electra Glide and Tri Glide models. Does not fit with Original Equipment or accessory Wind Deflectors. Does not fit with Fairing Mounted GPS Navigation Systems.



B. THREE-POCKET FAIRING POUCH (SHOWN WITH GPS MOUNT) – '96-'13 MODELS



C. LEATHER FAIRING POUCH

Notice: The prices appearing in this catalog are the manufacturer's suggested retail prices. Actual retail prices may vary.



# LUGGAGE 787

Storage



**D. RIDER CUP HOLDER**

## D. RIDER CUP HOLDER

Shaped to blend with the contours of your Harley-Davidson® motorcycle, this unique cup holder is easy to reach without cluttering the handlebar. The attractive chrome mount securely attaches to the frame downtube and sweeps rearward to support the cup holder. The soft-touch insulated holder flexes to grip the beverage and features a perforated bottom to drain away rain water. Kit includes model-specific clamp, support rod, cup holder and all required mounting hardware.

**57478-11** \$49.95

Fits '06-later Dyna® models (except FLD).

**50700002** \$54.95

Fits '00-later Softail® models without ABS Brakes.

**50700001** \$54.95

Fits '09-later Touring and Trike models. Does not fit '14-later models equipped with Fairing Lower.

## E. BILLET STORAGE TUBE

Machined from 6061 billet aluminum, this finely detailed Billet Storage Tube offers a convenient storage location for essential tools, sunglasses (2.0" versions) or registration papers. The mirror-chrome "ball-milled" tube features water-resistant threaded and O-ring sealed end caps on both ends for convenient access. The billet mounting clamp is adjustable for position and allows interference-free installation on the front down tube of the specified models. Available in three sizes for every storage need. Includes all necessary mounting hardware.

Fits '00-'03 XL, '00-'05 Dyna and '00-later Softail models (except models with ABS brakes). Fits FLS, FXSB and FXSBSE models with ABS.

**64101-03** Large. \$169.95  
10.0" long x 2.0" diameter.

**64100-03** Medium. \$159.95  
7.0" long x 2.0" diameter.

**64120-06** Mini. \$139.95  
7.5" long x 1.0" diameter.



**E. BILLET STORAGE TUBE – LARGE**



**E. BILLET STORAGE TUBE – MEDIUM**



**E. BILLET STORAGE TUBE – MINI**



**E. BILLET STORAGE TUBE – MEDIUM**

### Model Family Fitment:

- V-ROD
- SPORTSTER
- DYNA
- SOFTAIL
- TOURING

*Notice: The prices appearing in this catalog are the manufacturer's suggested retail prices. Actual retail prices may vary.*

# 788 LUGGAGE

## Travel-Paks

### A. PREMIUM TRAVEL-PAKS

This collection of fitted luggage provides convenient storage for your next long ride. The bags are manufactured of water resistant ballistic nylon that matches the premium luggage collection. The exterior features comfortable carrying handles, heavy-duty glove-friendly zippers, a zippered pocket, D-rings for optional carrying straps. The padded interior features a variety of convenient storage pockets and plenty of open storage. Saddlebag right-hand bag features an internal padded laptop pocket and plenty of smart storage spaces.

**93300072** King Tour-Pak®. **\$99.95**  
Fits '93-later Touring and Trike models equipped with King Tour-Pak luggage.

**93300071** Chopped Tour-Pak. **\$89.95**  
Fits '93-later Touring and Trike models equipped with Chopped Tour-Pak luggage.

**93300070** Hard Saddlebags. **\$129.95**  
Fits '93-later Touring models equipped with hard saddlebags. Sold in pairs.



A. PREMIUM TRAVEL-PAK – KING TOUR-PAK

### B. TRAVEL-PAKS

Simplify packing and unpacking your motorcycle. These well-constructed, water-resistant bags are designed to fit perfectly into Touring model luggage systems. The soft sides conform to the interior of the luggage to help use every available inch of space. Styled with a Bar & Shield logo, they feature heavy-duty zippers and convenient carrying handles.

**53605-97** King Tour-Pak. **\$59.95**  
Fits '93-later Touring and Trike models equipped with King and Ultra Tour-Pak luggage.

**91783-96** Chopped Tour-Pak. (not shown) **\$54.95**  
Fits '97-later Touring and Trike models equipped with Chopped Tour-Pak luggage.

**91885-97A** Hard Saddlebags. **\$59.95**  
Fits '93-later Touring models equipped with Color-Matched Hard Saddlebags and '09-later VRSCF models equipped with Rigid Saddlebags P/N 91172-09. Sold in pairs.

**53621-98** Leather Tour-Pak. **\$49.95**  
Fits '96-'13 XL, Softail® Touring models equipped with Leather Tour-Pak luggage.

**91887-98** Leather Saddlebags. (not shown) **\$59.95**  
Fits '98-later FLHRC and FLHRS models. Sold in pairs.



A. PREMIUM TRAVEL-PAK – CHOPPED TOUR-PAK

A. PREMIUM TRAVEL-PAK – HARD SADDLEBAGS

### C. SADDLEBAG TRAVEL-PAKS

Water-resistant liners make packing easy. Features inner pockets for extra storage and an embroidered Bar & Shield logo.

**91959-97** **\$54.95**  
Liner dimensions: 12.0" W x 10.0" T x 5.0" D.



B. TRAVEL-PAK – KING TOUR-PAK

B. TRAVEL-PAK – HARD SADDLEBAGS



B. TRAVEL-PAK – LEATHER TOUR-PAK

C. SADDLEBAG TRAVEL-PAKS

*Notice: The prices appearing in this catalog are the manufacturer's suggested retail prices. Actual retail prices may vary.*



# LUGGAGE 789

Bungees & Tie-Downs



D. SADDLEBAG COOLER



## D. SADDLEBAG COOLER

Keep beverages and snacks cold right in your saddlebag on those hot summer rides. This zippered bag is fully lined and insulated and fits the full length of your saddlebag.

**90200991** \$69.95

Fits '93-later Touring models equipped with Color-Matched Hard Saddlebags.

## E. BUNGEE CORD SOFT-HOOK EXTENSIONS

Keep your luggage firmly in place. Simply loop these soft-hook extensions around your luggage rack bar and you have a secure connection point for bungee hooks. Manufactured from a strong but flexible material, the soft-hook extensions provide convenient connection points anywhere around the luggage rack. When tightly secured around the rack bar, these soft-hook extensions will not slide, reducing the potential for luggage shift during transit.

**52300140** Set of 4. \$14.95

For use on all luggage racks with rails up to .75" diameter.



E. BUNGEE CORD SOFT-HOOK EXTENSIONS



## F. BLACK CARGO NETS

These versatile nets feature vinyl-coated attaching hooks to hold your cargo securely. For helmets, small packages, etc. Works great with chrome bungee nuts.

**97008-07** 12.0" x 12.0" - 4 hook. \$10.95

**98170-88T** 15.0" x 15.0" - 6 hook. \$11.95

**98169-88T** 18.0" x 18.0" - 6 hook. \$12.95

## G. BLACK BUNGEE CORDS

**98196-85T** 18.0" length. \$2.95

**98197-85T** 24.0" length. \$2.95

**98198-85T** 30.0" length. \$2.95

**98199-85T** 24.0" length - 4 hook. \$4.95

## H. CHROME BUNGEE NUTS

**98184-90T** .375" - 24 thread. (pair) \$7.95

**98185-90T** .375" - 16 thread. (pair) \$7.95



F. BLACK CARGO NET



G. BLACK BUNGEE CORDS



H. CHROME BUNGEE NUTS

### Model Family Fitment:

- V-ROD
- SPORTSTER
- DYNA
- SOFTAIL
- TOURING

Notice: The prices appearing in this catalog are the manufacturer's suggested retail prices. Actual retail prices may vary.

# 790 LUGGAGE

## Luggage Accessories

### A. DECORATIVE CONCHOS

Stylish Harley-Davidson® conchos can customize anything, from saddlebags and seats to tank pouches and tool bags. Includes Rosette & Lacing Strap.

**91877-97** Package quantity 1. **\$7.95**

### B. "HARLEY-DAVIDSON/U.S.A." CUSTOM CONCHO

Conchos are polished, nickel-plated and identified with a recessed "Harley-Davidson Motorcycles – U.S.A." logo in contrasting black. Attaches securely with a tie wrap. Rosette & Lacing Strap sold separately.

**91857-91** Package quantity 1. **\$5.95**

#### Shown with:

#### LEATHER ROSETTE AND LACING STRAP FOR "HARLEY-DAVIDSON/U.S.A." CUSTOM CONCHO

Available in black, these leather accents can be used when attaching H-D® custom conchos.

**91722-04** Package quantity 1. **\$13.95**

### C. DECORATIVE SPOTS

Make your own personal styling statement by identifying your leather jacket, cap, saddlebags, sissy bar bag, etc., with Decorative Spots that are made of rustproof, nickel-plated solid brass.

#### Decorative Chrome Spots

**93023-88** Round .75". **\$0.25**

**93024-88** Round .50". **\$0.25**

**93025-88** Round .25". **\$0.20**

#### Decorative Road King® Black Jeweled Spot

**93036-95** Matches FLHR models. **\$1.95**

#### Decorative Heritage Chrome Spot

**93037-09** Matches FLSTC models. (Package quantity 1.) **\$1.95**

### D. SADDLEBAG STRAP REPAIR KIT

Features rivets and washers required for saddlebag strap repair. Kit includes 16 rivets (4 sizes) and 16 washers.

**88272-06** **\$11.95**



A. DECORATIVE CONCHOS



B. "HARLEY-DAVIDSON/U.S.A." CUSTOM CONCHO AND LEATHER ROSETTE AND LACING STRAP



C. DECORATIVE SPOTS – CHROME



C. DECORATIVE SPOTS – ROAD KING BLACK JEWELLED

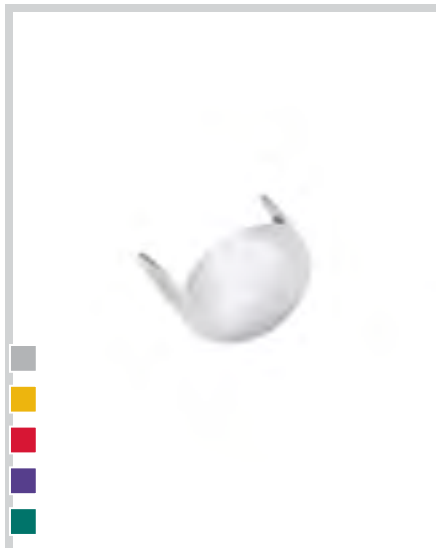

C. DECORATIVE SPOTS – HERITAGE CHROME



D. SADDLEBAG STRAP REPAIR KIT

Notice: The prices appearing in this catalog are the manufacturer's suggested retail prices. Actual retail prices may vary.





**E. PREMIUM AMERICAN FLAG KIT**



**F. AMERICAN FLAG KIT**



**G. POW/MIA FLAG KIT**

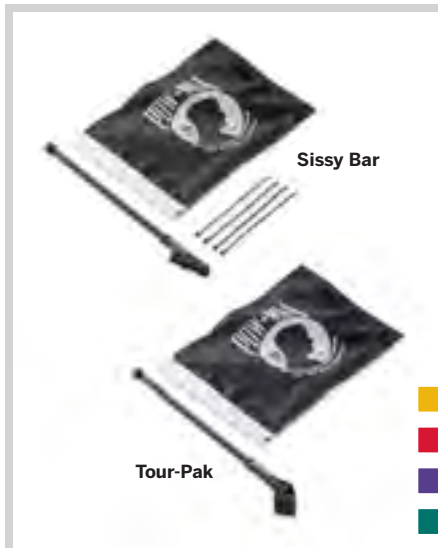

**E. PREMIUM AMERICAN FLAG KIT**

Proudly display Old Glory with this Premium Flag and Mast Kit. The mast features a rich bullet shaped final tip and a spring-mount base that easily attaches to your Luggage Rack with a chrome-plated billet clamp. The high-quality 14.0" x 11.0" nylon flag features hemmed and double-stitched edges for durability. Kit includes American flag, chrome billet mounting bracket, flag mast and all required hardware. (Flags are designed for parade use only and will not withstand high-speed use.)

**61400074** **\$64.95**

Fits Air Wing Tour-Pak® Luggage Rack P/N 79179-08, 53000063 or 50300097, Premium Tour-Pak Luggage Rack P/N 53665-87, Contoured Tour-Pak Luggage Rack P/N 79148-06A and all luggage racks with .5" diameter round outer bar.

**F. AMERICAN FLAG KIT**

Whether showing your patriotism or your love of Harley® motorcycles, showing your colors is easier than ever with quality flag and mast kits. Flags are made with high-quality nylon for durability. Available in sissy bar mount or Tour-Pak Luggage Carrier/Saddlebag mount. (Flags are designed for parade use only and will not withstand high-speed use.)

**61400206** **\$39.95**

Mounts to '14-later Touring and Tri Glide® models with Color-Matched Tour-Pak Luggage Carriers. Does not fit Leather Tour-Pak Luggage.

**94626-98** **\$34.95**

Mounts to '93-'13 Touring and Trike models equipped with Color-Matched Tour-Pak luggage carriers or Hard Saddlebags. Does not fit Leather Tour-Pak luggage. Also fits many car and truck roll-down windows.

**94616-98** **\$34.95**

Fits Sissy Bars (except Mini and Short Uprights with Backrest Pads).

**94625-98** Replacement flag only. **\$19.95**

**G. POW/MIA FLAG KIT**

Show support for the American POW and MIA military forces with this flag and mast kit. Flags are made with high-quality nylon for durability. Available in sissy bar mount or Tour-Pak Luggage Carrier/Saddlebag mount versions. (Flags are designed for parade use only and will not withstand high-speed use.)

**61400205** **\$39.95**

Mounts to '14-later Touring and Tri Glide models with Color-Matched Tour-Pak Luggage Carriers. Does not fit Leather Tour-Pak Luggage.

**94901-03** **\$34.95**

Mounts to '93-'13 Touring and Trike models equipped with Color-Matched Tour-Pak luggage carriers or Hard Saddlebags. Does not fit Leather Tour-Pak luggage. Also fits many car and truck roll-down windows.

**94900-03** **\$34.95**

Fits Sissy Bars (except Mini and Short Uprights with Backrest Pads).

**94902-03** Replacement POW/MIA flag only. **\$19.95**

**Model Family Fitment:**

- V-ROD
- SPORTSTER
- DYNA
- SOFTAIL
- TOURING

*Notice: The prices appearing in this catalog are the manufacturer's suggested retail prices. Actual retail prices may vary.*



GENUINE MOTOR PARTS & ACCESSORIES



2015

## COLOR SHOP & CUSTOM SEATS

Make a big, bold personal statement with a Color Shop custom paint set and matching custom-stitched seat. You'll appreciate your choices every time you flip on the light in your garage – and sense the stares of strangers as you roll on down the road.





## ARTISTRY IN STEEL AND LEATHER

Think of the bike as a blank canvas, a surface ready to express your personality with design, color and texture. A Harley-Davidson® Color Shop paint set and a complementing custom seat establish the tone for the rest of the accessories and set your bike apart from the crowd.

### COLOR SHOP CUSTOM PAINT

No surprises. Pick your style — and we deliver a custom stand-out look without the one-off custom worries. We handpick our artists and continually monitor their painting techniques and finish quality. Every unique set will have subtle differences associated with the artist's hand, but you will know from the start what the finished look will be.

### COLOR SHOP CUSTOM SEATS

We believe customizing your seat shouldn't be a painful process. So we do away with the hassles. You can actually "test sit" a Brawler® or Sidekick® seat at a Harley-Davidson® dealer. You select from over 1,300 design options and visually build your seat on the web to eliminate the design guesswork. And you don't need to send your seat across the country and hope you get it back before the riding season is over.





# CUSTOM SEAT OPTIONS & ORDERING



## DESIGN IT YOURSELF

We make it simple. Log on to design your seat and watch it come to life. Select the pattern, the inlay and the color, then bring the specs to your dealer and have your seat in hand in just three weeks. Your dealer has a useful swatch book of all inlay materials and stitching options to help you make your choices.

*To get started, visit [www.h-d.com/customseat](http://www.h-d.com/customseat)*



### STEP 1: SELECT A SEAT

Choose from the Brawler® solo or the Sidekick® two-up seat.

### STEP 2: SELECT A STITCH PATTERN & COLOR

Choose from eight different flame, skull or tribal designs, stitched in your choice of ten different colors that complement your bike's paint and pinstripes.

### STEP 3: SELECT AN INLAY MATERIAL & COLOR

Embossed leather inlays are available in ten colors and styles to match your bike's personality.

### STEP 4: PRINT IT OUT

Print out your design, take it to your Harley® dealership and you'll have your seat in just three weeks.



**SELECT A SEAT**

Available in Brawler® solo and Sidekick® two-up designs, these custom saddles are styled to accent the lines of many Sportster®, Dyna®, Softail® and Touring models. Shaped from premium open-cell polyurethane foam, these seats provide maximum rider support, without being "too hard." The fiberglass seat pan adds strength and flexibility and the felt-covered underside protects the paint and bodywork. The high-quality fine-grained leather seating surfaces provide ultimate comfort and the vinyl side panels add flexibility and durability for the long haul.

**CUSTOM BRAWLER® SOLO SEAT**

When it's time to go it alone, go solo in style. This premium quality cowhide leather saddle is designed to create a low and lean look.

- 52000118** **\$399.95**  
Fits '04-later XL models equipped with 3.3 gallon fuel tank. Seat width 12.5".
- 52000119** **\$399.95**  
Fits '04-later XL models equipped with 4.5 gallon fuel tank. Seat width 12.5".
- 51621-09** **\$399.95**  
Fits '06-later Dyna models. Seat width 12.5".
- 52246-08** **\$399.95**  
Fits '07-later FLSTF, FLSTFB, FLSTSB and '06-later FXST, FXSTB, FXSTC and FXSTS models (except FXSTSSE/2/3). Seat width 13.0".
- 51619-09A** **\$399.95**  
Fits '08-later Touring models. Does not fit Trike models. Does not fit models equipped with Passenger Grab Rails. Does not accept Rider Backrest. Seat width 13.0".
- 51800-09** **\$399.95**  
Fits '97-'07 Road King® and FLHX models. Does not accept Rider Backrest. Seat width 13.0".

**CUSTOM SIDEKICK® TWO-UP SEAT**

This premium cowhide leather seat hugs the frame for a low-slung look but adds back support for the rider and extra padding for the passenger.

- 52000120** **\$499.95**  
Fits '04-later XL models equipped with 3.3 gallon fuel tank. Models not equipped with passenger pegs require separate purchase of Passenger Footpeg Kit. P/N 50203-04 ('04-'13 models) or P/N 50500270 ('14-later models). XL1200N and XL1200X models also require separate purchase of Retention Washer P/N 7487. Seat width 12.5"; passenger pillion width 5.0".
- 52000121** **\$499.95**  
Fits '04-later XL models equipped with 4.5 gallon fuel tank. Models not equipped with passenger pegs require separate purchase of Passenger Footpeg Kit. Seat width 12.5"; passenger pillion width 5.0".
- 51626-09** **\$479.95**  
Fits '06-later Dyna models. FXD and FXDB models require separate purchase of Passenger Footpegs and Passenger Footpeg Mounting Kit. Seat width 12.5"; passenger pillion width 6.0".
- 52193-08** **\$479.95**  
Fits '07-later FLSTF, FLSTFB, FLSTSB and '06-later FXST, FXSTB, FXSTC and FXSTS models (except FXSTSSE/2/3). Seat width 12.5"; passenger pillion width 6.5".
- 51620-09A** **\$479.95**  
Fits '08-later Touring models. Does not fit Trike models. Does not fit models equipped with Passenger Grab Rails. Does not accept Rider Backrest. Seat width 13.5"; passenger pillion width 6.5".
- 51745-09** **\$479.95**  
Fits '97-'07 Road King and FLHX models. Does not accept Rider Backrest. Seat width 13.5"; passenger pillion width 6.5".

*Notice: The prices appearing in this catalog are the manufacturer's suggested retail prices. Actual retail prices may vary.*

**SELECT A STITCH PATTERN & COLOR**

AVAILABLE THREAD COLORS Saddle | Yellow | Orange | Red | Black Cherry | Blue | Green | Grey | Titanium | Black

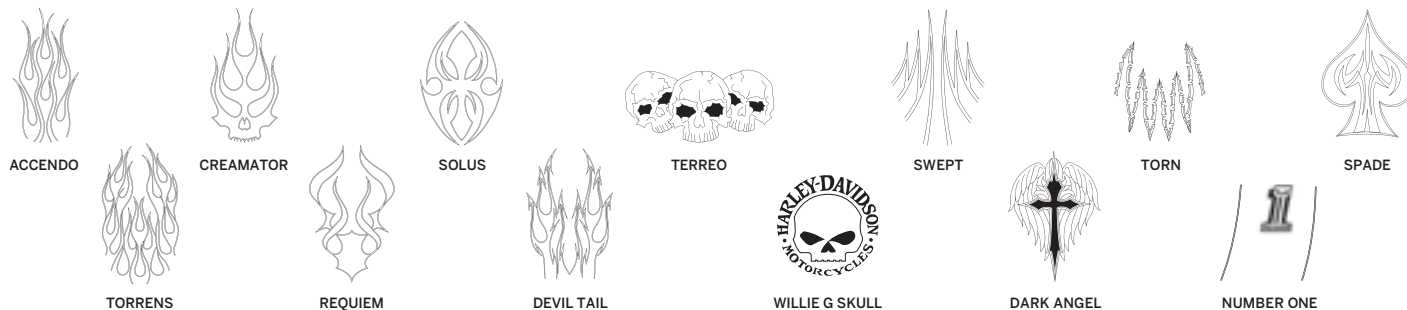

**SELECT AN INLAY MATERIAL & COLOR**



The realistic Alligator, Ostrich and Snakeskin textures are embossed in natural cowhide leather.

*NOTE: Harley-Davidson® custom seats feature color-matched stitching and/or stylized surfaces for maximum customization. As with all genuine cowhide leather, these surfaces are not designed for long-term exposure to inclement weather and should be protected with a Harley-Davidson Seat Rain Cover or Motorcycle Storage Cover (sold separately).*

---

## COLOR SHOP LIMITED CUSTOM PAINT

It's hard to believe this look is available directly from the factory. The Motor Company commissions only a handful of custom designs each year. Each hand-painted set has been lovingly created by a small team of artists and specialists, exercising their vast skills to deliver depth and dimension unknown in production paint. And because Harley-Davidson hand-picks our custom painters, we can stand behind each Limited Series paint set with an unmatched 2-year Harley-Davidson® warranty when installed under the Custom Coverage Program.

**Color Shop Limited Series** paint gets you the stand-out custom looks you crave, without the guesswork and anxiety when having your bike painted by a local body shop.





**COLOR SHOP LIMITED SERIES — ARCTIC FLASH**

Come towards the light. Like the great northern lights, waves of white dance against the black night sky as the last red streaks of the setting sun illuminate the horizon. Solar winds move the curtains of light across the flanks of the bike to magnetically draw your eye from one end to the other. Limited availability – only 150 sets will be offered. Sets ship November 2014. See your dealer today.

See page 801 for available fitments.



**COLOR SHOP LIMITED SERIES – ARCTIC FLASH  
(SHOWN ON STREET GLIDE® MODEL)**



**COLOR SHOP LIMITED SERIES – ARCTIC FLASH  
(SHOWN ON ROAD GLIDE® MODEL)**

# 800 COLOR SHOP

Limited Series Custom Paint

## COLOR SHOP LIMITED SERIES — MIDNITE BLAZE

Set the sky on fire. Like the return of Halley's Comet, the rich fire orange and radiant yellow tail streaks across the midnight black heavens, demanding that everyone stop and take notice. The fine airbrushed shadows add depth and dimension and leave the impression of shimmering heat rising from the cold background. Limited availability – only 150 sets will be offered. Sets ship December 2014. See your dealer today.

See page 801 for available fitments.



COLOR SHOP LIMITED SERIES – MIDNITE BLAZE  
(SHOWN ON BREAKOUT® MODEL)



COLOR SHOP LIMITED SERIES – MIDNITE BLAZE  
(SHOWN ON ROAD GLIDE® MODEL)





Available to fit:

	LIMITED: MIDNITE BLAZE	LIMITED: ARCTIC FLASH
<b>Sportster® Forty-Eight®</b> Fits '10-'15 XL1200X models (except models for Mexico and Canada).	92200117DYZ \$2,499.95	—
<b>Sportster Forty-Eight</b> Fits '10-'15 XL1200X Mexico and Canada models.	92200118DYZ \$2,499.95	—
<b>Dyna® Fat Bob®</b> Fits '14-'15 FXDF models.	92200113DYZ \$2,599.95	—
<b>Slim®</b> Fits '12-'15 FLS models.	92200110DYZ \$2,699.95	—
<b>Breakout®</b> Fits '13-'15 FXSB Models.	92200109DYZ \$2,699.95	—
<b>Fat Boy®</b> Fits '11-'15 FLSTF and FLSTFB models. Requires separate purchase of Dampening Kit P/N 60832-07.	92200107DYZ \$2,799.95	—
<b>Road King®</b> Fits '14-'15 FLHR models. Color-Matched saddlebags sold separately.	—	92200101DYV \$3,199.95
<b>Street Glide®</b> Fits '14-'15 FLHX & FLHXS DOM & HDI (except Canada and Mexico models). Color-Matched saddlebags sold separately.	—	92200127DYV \$4,199.95
<b>Street Glide</b> Fits '14-'15 FLHX & FLHXS Canada and Mexico models. Color-Matched saddlebags sold separately.	—	92200103DYV \$4,199.95
<b>Road Glide®</b> Fits '15 FLTRX and FLTRXS models (except Canada and Mexico models). Color-Matched saddlebags sold separately.	92200125DYZ \$4,299.95	92200104DYV \$4,299.95
<b>Road Glide</b> Fits '15 FLTRX and FLTRXS Canada and Mexico models. Color-Matched saddlebags sold separately.	92200126DYZ \$4,299.95	92200123DYV \$4,299.95
<b>Standard Saddlebags</b> Fits '14-'15 Touring models.	92200068DYZ \$1,699.95	92200068DYV \$1,699.95
<b>Stretched Saddlebags</b> Fits '14-'15 Touring models.	92200069DYZ \$1,799.95	92200069DYV \$1,799.95
<b>Stretched Boom!™ Audio Saddlebags</b> Fits '14-'15 Touring models.	92200070DYZ \$1,799.95	92200070DYV \$1,799.95
<b>Inner Fairing–Batwing</b> Fits '14-'15 FLHX & FLHXS models.	—	57000389DZM \$749.95
<b>Inner Fairing–Road Glide</b> Fits '15 Road Glide models.	57000536DYP \$1,499.95	57000536DZM \$1,499.95
<b>Chopped Tour-Pak®</b> Fits '14-'15 Touring models.	92200073DYZ \$1,699.95	92200073DYV \$1,699.95

Notice: The prices appearing in this catalog are the manufacturer's suggested retail prices. Actual retail prices may vary.

## COLOR-MATCHED BODYWORK

Wish you could splash more of your factory color over your bike's profile? Consider Color Shop's Accessory Bodywork. This collection of primed and color-matched components endows your Harley with a personality of its own. Tour-Pak® luggage, stretched saddlebags, inner fairings and spoilers are available in factory-matched colors for most late model Harley® motorcycles.





# COLOR SHOP 803

Fairings



A. H-D DETACHABLES QUARTER FAIRING KIT – VIVID BLACK

## A. H-D® DETACHABLES™ QUARTER FAIRING KIT\*

Sleek, racy styling and sweeping lines define this innovative fairing. The quarter fairing-sized detachable design gives your bike a whole new sporty look that can be changed in an instant. Available in primed or Vivid Black finish, the fairing is interchangeable with H-D® Detachables™ Windshields, giving you plenty of options for cruising or touring. Plus, the windshield has a two-position adjustment feature for flexibility.

Fits '88-later XL (except XL Custom, XL1200X, XL1200N, XL1200T, XL883N and '11-later XL883L), FXR and '95-'05 Dyna® models (except FXLR, FXDWG and FXDXT). Requires the installation of Docking Hardware Kit P/N 58164-96A.

<b>57070-98</b>	Primed.	<b>\$279.95</b>
<b>57070-97DH</b>	Vivid Black.	<b>\$399.95</b>

## B. HEADLAMP VISOR KITS\*

Add an element of racy style to stock headlamps with these visors. Available in Primed or Vivid Black Harley-Davidson® paint.

Fits '95-later XL (except XL Custom, XL1200V and XL1200X), '95-'05 Dyna (except FXDXT and FXDWG) and '82-'94 FXR and FXRS models.

<b>68129-97</b>	Primed.	<b>\$119.95</b>
<b>68129-98DH</b>	Vivid Black.	<b>\$229.95</b>

Fits '84-'99 FXST, FXSTC and '91-'05 FXDWG models.

<b>68971-98B</b>	Primed.	<b>\$119.95</b>
------------------	---------	-----------------

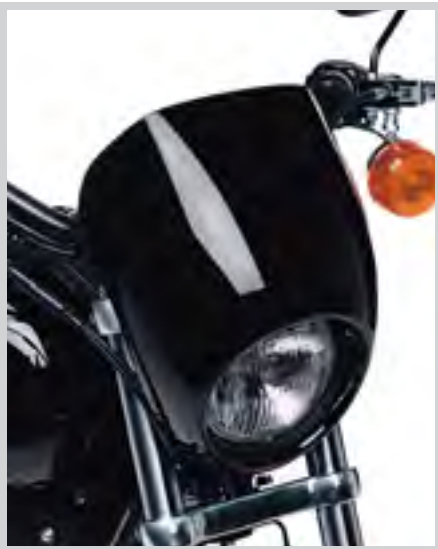

B. HEADLAMP VISOR KIT (SPORTSTER AND DYNA) – VIVID BLACK



B. HEADLAMP VISOR KIT (FXST/C AND FXDWG) – VIVID BLACK

\*NOTE: This product is a "Paint to Order" accessory. Please allow for an average of 5 weeks delivery for this item.

Notice: The prices appearing in this catalog are the manufacturer's suggested retail prices. Actual retail prices may vary.

# 804 COLOR SHOP

Color-Matched Accessories

## COLOR-MATCHED INNER FAIRING KIT\*

Add a custom touch to your motorcycle with a Color-Matched Inner Fairing and Fairing Cap. Designed to replace the Original Equipment matte black inner fairing, the color-matched finish offers a brilliant contrast to the gauge faces and accessory chrome instrument bezels.

### COLOR-MATCHED BATWING INNER FAIRING – Available to fit:

Fits '14-later Electra Glide® and Street Glide® models with handlebar mounted mirrors. Kit includes inner fairing, fairing cap, and media door. Does not fit Tri Glide® models.

Fits '14-later Street Glide models with fairing mounted mirrors. Kit includes inner fairing, fairing cap, and media door. Does not fit Tri Glide models.

Fits '08-'13 Electra Glide and Street Glide models. Kit includes inner fairing and fairing cap.

Fits '04-'07 Electra Glide and Street Glide models. Kit includes inner fairing and fairing cap.

### COLOR-MATCHED TRIKE INNER FAIRING – Available to fit:

Fits '14-later Tri Glide® models. Kit includes inner fairing, fairing cap, and media door.

Fits '09-'13 Trike models. Kit includes inner fairing and fairing cap.

### COLOR-MATCHED ROAD GLIDE® INNER FAIRING – Available to fit:

Fits '15-later Road Glide models. Color-Matched Inner Fairing Air Duct sold separately.

Fits '06-'13 Road Glide models. Kit includes inner fairing, instrument housing and glove box doors.

### COLOR-MATCHED ROAD GLIDE AIR DUCT – Available to fit:

Fits '15-later Road Glide models. Color-Matched Inner Fairing sold separately. Kit includes air duct baffle and actuator assembly.



### \*Color-Matched Accessory Ordering Information:

Color, pinstripe and model information is provided for reference. When ordering Color-Matched Accessories, verify you have the correct accessory P/N by matching the paint suffix code (alpha characters at the end of the P/N) to the paint suffix code of painted service parts for the same bike. Please see your dealer for assistance matching paint codes.

NOTE: This product is a "Paint to Order" accessory. Please allow for an average of 5 weeks delivery for this item.



**Batwing Inner Fairing  
Fits '14-later Electra Glide® and  
Street Glide® models with handlebar  
mounted mirrors**

**Batwing Inner Fairing  
Fits '14-later Street Glide models  
with fairing mounted mirrors**

**Batwing Inner Fairing  
Fits '14-later Tri Glide® models**

Solid Color	P/N	Price	P/N	Price	P/N	Price
Primed/Paintable	57000398	\$549.95	57000400	\$549.95	57000399	\$549.95
Amber Whiskey	57000387DST	\$649.95	57000389DST	\$649.95	—	—
Big Blue Pearl	57000387DJO	\$649.95	57000389DJO	\$649.95	57000388DJO	\$649.95
Black Denim	—	—	57000389BYM	\$649.95	—	—
Black Magic	57000387DWV	\$649.95	—	—	57000388DWV	\$649.95
Blackened Cayenne	57000387DSZ	\$649.95	57000389DSZ	\$649.95	57000388DSZ	\$649.95
Brilliant Silver	57000387BHT	\$649.95	57000389BHT	\$649.95	—	—
Candy Orange	57000387DPU	\$649.95	—	—	—	—
Charcoal Pearl	57000387DTF	\$649.95	57000389DTF	\$649.95	—	—
Charcoal Satin	—	—	57000389DUM	\$649.95	—	—
Daytona Blue	57000387DUA	\$699.95	57000389DUA	\$699.95	—	—
Deep Jade Pearl	57000387DWF	\$649.95	57000389DWF	\$649.95	—	—
Midnight Pearl	57000387DKJ	\$649.95	—	—	—	—
Morocco Gold	—	—	57000389DTC	\$649.95	—	—
Mysterious Red Sunglo	57000387DSW	\$649.95	57000389DSW	\$649.95	57000388DSW	\$649.95
Radioactive Green	57000387DWJ	\$649.95	57000389DWJ	\$649.95	—	—
Sand Camo Denim	—	—	57000389DSR	\$649.95	—	—
Sand Pearl	57000387DUN	\$649.95	—	—	57000388DUN	\$649.95
Superior Blue	57000387DWC	\$649.95	57000389DWC	\$649.95	—	—
Vivid Black	57000387DH	\$649.95	57000389DH	\$649.95	57000388DH	\$649.95
White Hot Pearl	57000387DJI	\$649.95	—	—	57000388DJI	\$649.95

Notice: The prices appearing in this catalog are the manufacturer's suggested retail prices. Actual retail prices may vary.





Solid Color	Batwing Fairing Fits '04-'07 Electra Glide® and Street Glide® models		Batwing Fairing Fits '08-'13 Electra Glide and Street Glide models		Batwing Fairing Fits '09-'13 Trike models	
	P/N	Price	P/N	Price	P/N	Price
Primed/Paintable	58508-09BDK	\$499.95	58468-09BDK	\$499.95	—	—
Anniversary Vintage Bronze	—	—	58468-13DPY	\$599.95	83527-13DPY	\$599.95
Big Blue Pearl	—	—	58468-12DJO	\$599.95	83527-12DJO	\$599.95
Black Cherry	58508-09BPS	\$599.95	—	—	—	—
Black Ice Pearl	—	—	58468-09CWL	\$599.95	—	—
Black Pearl	58508-09BPY	\$599.95	58468-09BPY	\$599.95	—	—
Brilliant Silver Pearl	—	—	58468-10BHT	\$599.95	—	—
Cherry Red Sunglo	—	—	58468-10DCG	\$599.95	—	—
Chrome Yellow Pearl	—	—	58468-13DPR	\$599.95	—	—
Crimson Red Sunglo	—	—	58468-09COZ	\$599.95	—	—
Dark Blue Pearl	—	—	58468-09CPC	\$599.95	—	—
Dark Candy Root Beer	—	—	58468-10DID	\$599.95	—	—
Deep Cobalt	58508-09BXT	\$599.95	—	—	—	—
Ember Red Sunglo	—	—	58468-12DJS	\$599.95	83527-12DJS	\$599.95
Flame Blue Pearl	—	—	58468-09CWA	\$599.95	—	—
Light Candy Root Beer	—	—	58468-09CWT	\$599.95	—	—
Merlot Sunglo	—	—	58468-10DCE	\$599.95	—	—
Midnight Pearl	—	—	58468-12DKJ	\$599.95	—	—
Pewter Pearl	—	—	58468-09CGR	\$599.95	—	—
Red Hot Sunglo	—	—	58468-09CYS	\$599.95	—	—
Sedona Orange	—	—	58468-10DGX	\$599.95	—	—
Tequila Sunrise	—	—	58468-12DKO	\$599.95	—	—
Vivid Black	58508-09DH	\$599.95	58468-09DH	\$599.95	83527-10DH	\$599.95
White Gold Pearl	—	—	58468-09CGS	\$599.95	—	—
White Hot Pearl	—	—	58468-12DJI	\$599.95	—	—



Solid Color	Road Glide® Inner Fairing Fits '15-later models		Road Glide Fairing Air Duct Fits '15-later models		Road Glide Inner Fairing Fits '06-'13 models	
	P/N	Price	P/N	Price	P/N	Price
Primed/Paintable	57000482BYM	\$1,149.95	29200102BYM	\$349.95	58722-09BDK	\$849.95
Amber Whiskey	57000482DST	\$1,149.95	29200102DST	\$349.95	—	—
Big Blue Pearl	—	—	—	—	58722-12DJO	\$1,099.95
Black Denim	57000482BYM	\$1,149.95	29200102BYM	\$349.95	—	—
Candy Orange	—	—	—	—	58722-13DPU	\$1,099.95
Ember Red Sunglo	—	—	—	—	58722-12DJS	\$1,099.95
Merlot Sunglo	—	—	—	—	58722-10DCE	\$1,099.95
Midnight Pearl	—	—	—	—	58722-13DKJ	\$1,099.95
Mysterious Red Sunglo	57000482DSW	\$1,149.95	29200102DSW	\$349.95	—	—
Sedona Orange	—	—	—	—	58722-10DGX	\$1,099.95
Superior Blue	57000482DWC	\$1,149.95	29200102DWC	\$349.95	—	—
Vivid Black	57000482DH	\$1,149.95	29200102DH	\$349.95	58722-09DH	\$1,099.95

Notice: The prices appearing in this catalog are the manufacturer's suggested retail prices. Actual retail prices may vary.

# 806 COLOR SHOP

## Color-Matched Accessories

### COLOR-MATCHED TOUR-PAK® LUGGAGE\*

When you're serious about racking up miles, Tour-Pak® luggage systems will help you pack for the trip. This Color-Matched hard luggage provides the capacity to pack for almost any riding condition. Tour-Pak luggage systems are available in two capacities: Chopped for a low-profile long and lean shape, and King to provide maximum storage space.

#### KING TOUR-PAK LUGGAGE – Available to fit:

Fits '09-'13 Electra Glide® Standard, Road King®, Road Glide®, Street Glide®, Street Glide Trike and select CVO™ models. Separate purchase of H-D® Detachables™ Two-Up or Solo Tour-Pak Mounting Rack and applicable Docking Hardware is required. Separate purchase of Tour-Pak Lock Kit P/N 53194-07 is required. FLHXXX models require addition of Tour-Pak Installation Kit P/N 54144-10 and Spacer Kit P/N 83294-10.

#### CHOPPED TOUR-PAK LUGGAGE – Available to fit:

Fits '97-'13 Touring models. FLHTCUTG models require separate purchase of Spacer Kit P/N 83294-10. FLHXXX models require addition of Tour-Pak Installation Kit P/N 54144-10 and Spacer Kit P/N 83294-10.

### \*Color-Matched Accessory Ordering Information:

Color, pinstripe and model information is provided for reference. When ordering Color-Matched Accessories, verify you have the correct accessory P/N by matching the paint suffix code (alpha characters at the end of the P/N) to the paint suffix code of painted service parts for the same bike. Please see your dealer for assistance matching paint codes.

NOTE: This product is a "Paint to Order" accessory. Please allow for an average of 5 weeks delivery for this item.



'09-'13



'97-'13

Solid Color	Inner/Outer Pinstripe	King Tour-Pak® Luggage		Chopped Tour-Pak Luggage	
		P/N	Price	P/N	Price
Big Blue Pearl	—	53963-12DJO	\$749.95	53111-12DJO	\$849.95
Black Denim	—	79071-10BYM	\$749.95	53111-09BYM	\$849.95
Black Pearl	—	79071-09BPY	\$749.95	53111-05BPY	\$849.95
Brilliant Silver Pearl	—	79071-10BHT	\$749.95	—	—
Chrome Yellow Pearl	—	53963-13DPR	\$749.95	53111-13DPR	\$849.95
Dark Blue Pearl	—	79071-09CPC	\$749.95	—	—
Ember Red Sunglo	—	53963-12DJS	\$749.95	53111-12DJS	\$849.95
Merlot Sunglo	—	53963-11DCE	\$749.95	53111-11DCE	\$849.95
Midnight Pearl	—	53963-12DKJ	\$749.95	53111-12DKJ	\$849.95
Pewter Pearl	—	79071-09CGR	\$749.95	—	—
Red Hot Sunglo	—	53963-10CYS	\$749.95	53111-09CYS	\$849.95
Scarlet Red	—	79071-10DBJ	\$749.95	53111-10DBJ	\$849.95
Sedona Orange	—	53963-11DGX	\$749.95	53111-11DGX	\$849.95
Vivid Black	—	53963-10DH	\$749.95	53111-96DH	\$849.95
White Gold Pearl	—	—	—	53111-07CGS	\$849.95
White Hot Denim	—	—	—	53111-11DHA	\$849.95
Big Blue Pearl	Blue	—	—	53111-12DJZ	\$849.95
Big Blue Pearl	Blue/Medium Silver	53963-12DJP	\$799.95	—	—
Black Denim	Medium Red	—	—	53111-10DBN	\$849.95
Black Denim	Medium Silver/Medium Silver	53963-09CWK	\$799.95	—	—
Candy Orange	Pale Gold	—	—	53111-13DPV	\$849.95
Ember Red Sunglo	Medium Red/Pale Gold	53963-12DJT	\$799.95	—	—
Flame Blue Pearl	Process Blue	53963-09CWB	\$799.95	—	—
Merlot Sunglo	Medium Red/Medium Red	53963-11DHD	\$799.95	—	—
Midnight Pearl	Blue/Pale Gold	53963-12DKF	\$799.95	—	—
Red Hot Sunglo	Pale Gold/Medium Red	53963-09CYT	\$799.95	—	—
Vivid Black	Medium Silver/Medium Silver	53963-09BHY	\$799.95	—	—
Vivid Black	Medium Silver	53963-12DBX	\$799.95	—	—
White Hot Pearl	Dark Blue/Medium Silver	53963-13DKC	\$799.95	—	—
<b>Solid Color/Panel</b>	<b>Inner/Outer Pinstripe</b>				
Anniversary Vintage Bronze/Vintage Black	Hamilton Gold/Brick Red	53963-13DPZ	\$849.95	53111-13DPZ	\$899.95
Big Blue Pearl/Vivid Black	Dark Blue/Medium Silver	53963-12DJQ	\$849.95	—	—
Candy Orange/Beer Bottle	Medium Red/Pale Gold	53963-13DPW	\$849.95	—	—
Ember Red Sunglo/Merlot	Medium Red/Pale Gold	53963-12DJU	\$849.95	—	—
Tequila Sunrise/H-D Orange	Medium Red/Pale Gold	53963-12DKP	\$849.95	53111-12DKP	\$899.95
<b>CVO™ Primary Color</b>	<b>Graphics</b>				
Atomic Orange	( '13 FLTRXSE)	53000076DRA	\$1,499.95	53000055DRA	\$1,599.95
Burgundy Blaze	( '13 FLHXSE)	53000076DQW	\$1,499.95	53000055DQW	\$1,599.95
Diamond Dust	( '13 FLHXSE/ '13 FLTRXSE)	53000076DRI	\$1,499.95	53000055DRI	\$1,599.95
Black Diamond	( '11 FLHXSE)	53000076CRP	\$1,499.95	53000055CRP	\$1,599.95
Candy Cobalt	( '12 FLTRXSE)	53000076DLA	\$1,499.95	53000055DLA	\$1,599.95
Dark Slate	( '12 FLHXSE)	53000076DKY	\$1,499.95	53000055DKY	\$1,599.95
Hot Citrus	( '12 FLHXSE)	53000076DKX	\$1,499.95	53000055DKX	\$1,599.95
Kryptonite	( '11 FLHXSE)	53000076DGA	\$1,499.95	53000055DGA	\$1,599.95
Maple Metallic	( '12 FLTRXSE)	53000076DLH	\$1,499.95	53000055DLH	\$1,599.95
Roman Gold	( '13 FLTRXSE)	53000076DRB	\$1,499.95	53000055DRB	\$1,599.95
Ruby Red	( '12 FLHXSE)	53000076DKW	\$1,499.95	53000055DKW	\$1,599.95
Spiced Rum	( '10 FLHXSE)	79071-10DEK	\$1,499.95	—	—
White Gold Pearl	( '12 FLTRXSE)	53000076DLN	\$1,499.95	53000055DLN	\$1,599.95

Notice: The prices appearing in this catalog are the manufacturer's suggested retail prices. Actual retail prices may vary.



**KING TOUR-PAK® LUGGAGE – Available to fit:**

Fits '14-later Road King®, Road Glide®, Street Glide® and select CVO™ models. Separate purchase of H-D® Detachables™ Two-Up or Solo Tour-Pak® Mounting Rack and applicable Docking Hardware is required. Separate purchase of Tour-Pak Lock Kit P/N 90300030 is required.

**CHOPPED TOUR-PAK LUGGAGE – Available to fit:**

Fits '14-later Road King, Road Glide, Street Glide and select CVO models. Separate purchase of H-D Detachables Two-Up or Solo Tour-Pak Mounting Rack and applicable Docking Hardware is required. Separate purchase of Tour-Pak Lock Kit P/N 90300030 is required.



'14-later



'14-later

Solid Color	Inner/Outer Pinstripe	King Tour-Pak® Luggage		Chopped Tour-Pak Luggage	
		P/N	Price	P/N	Price
Primed/Paintable	—	53000404	\$699.95	53000405	\$699.95
Amber Whiskey	—	53000399DST	\$849.95	53000402DST	\$849.95
Big Blue Pearl	—	53000399DJO	\$849.95	53000402DJO	\$849.95
Black Denim	—	53000399BYM	\$849.95	53000402BYM	\$849.95
Black Magic	—	53000443DWV	\$899.95	53000402DWV	\$849.95
Blackened Cayenne	—	53000399DSZ	\$849.95	53000402DSZ	\$849.95
Brilliant Silver	—	53000399BHT	\$849.95	53000402BHT	\$849.95
Charcoal Pearl	—	53000399DTF	\$849.95	53000402DTF	\$849.95
Charcoal Satin	—	53000399DUM	\$849.95	53000402DUM	\$849.95
Daytona Blue	—	53000399DUA	\$849.95	53000402DUA	\$849.95
Deep Jade Pearl	—	53000399DWF	\$849.95	53000402DWF	\$849.95
Morocco Gold	—	53000399DTC	\$849.95	53000402DTC	\$849.95
Mysterious Red Sunglo	—	53000399DSW	\$849.95	53000402DSW	\$849.95
Radioactive Green	—	53000443DWJ	\$899.95	53000402DWJ	\$849.95
Sand Camo Denim	—	53000399DSR	\$849.95	53000402DSR	\$849.95
Superior Blue	—	53000399DWC	\$849.95	53000402DWC	\$849.95
Vivid Black	—	53000399DH	\$849.95	53000402DH	\$849.95
Brilliant Silver	Medium Silver	53000377BJN	\$899.95	53000375BJN	\$899.95
Morocco Gold Pearl	Pale Gold/Pale Gold	53000377DTD	\$899.95	53000375DTD	\$899.95
Mysterious Red Sunglo	Medium Red/Burgundy	53000377DSX	\$899.95	53000375DSX	\$899.95
Superior Blue	Blue/Medium Silver	53000377DWK	\$899.95	53000375DWK	\$899.95
Vivid Black	Medium Silver/Medium Silver	53000377BHY	\$899.95	53000375BHY	\$899.95
<b>Solid Color/Panel</b>	<b>Inner/Outer Pinstripe</b>				
Amber Whiskey/Brilliant Silver	Burgundy/Pale Gold	53000377DTP	\$949.95	53000375DTP	\$949.95
Big Blue Pearl/Vivid Black	Dark Blue/Medium Silver	53000377DJQ	\$949.95	53000375DJQ	\$949.95
Brilliant Silver Pearl/Vivid Black	Med Red/Med Silver	53000377DWY	\$949.95	53000375DWY	\$949.95
Deep Jade Pearl/Vivid Black	Lt Green/Pale Gold	53000377DXD	\$949.95	53000375DXD	\$949.95
Mysterious Red/Blackened Cayenne Sunglo	Camo Tan/Medium Red	53000377DTI	\$949.95	53000375DTI	\$949.95
Sand Pearl/Canyon Brown	Burgundy/Amber Gold	53000377DUB	\$949.95	53000375DUB	\$949.95
<b>CVO™ Primary Color</b>	<b>Graphics</b>				
Tribal Orange and Graphics	('14 FLHRSE)	53000399DUF	\$1,599.95	53000402DUF	\$1,599.95
Titanium Dust and Graphics	('14 FLHRSE)	53000399DUG	\$1,599.95	53000402DUG	\$1,599.95
Deep Sherwood Pearl and Graphics	('14 FLHRSE)	53000399DUH	\$1,599.95	53000402DUH	\$1,599.95
HC Mercury	('15 FLHXSE)	92200074DXX	\$1,599.95	92200073DXX	\$1,599.95
Ultra Violet Blue	('15 FLHXSE)	92200074DXY	\$1,599.95	92200073DXY	\$1,599.95
Scorching Yellow	('15 FLHXSE)	92200074DXW	\$1,599.95	92200073DXW	\$1,599.95
Starfire Black	('15 FLHXSE)	92200074DXZ	\$1,599.95	92200073DXZ	\$1,599.95

**KING TOUR-PAK LUGGAGE – Available to fit:**

Fits '06-'08 Electra Glide® Standard, Road King, Road Glide and Street Glide models. Separate purchase of H-D Detachables Two-Up or Solo Tour-Pak Mounting Rack and applicable Docking Hardware is required. Separate purchase of Tour-Pak Lock Kit P/N 53194-07 is required.

Fits '07-'05 Electra Glide Standard, Road King, and Road Glide models. Separate purchase of H-D Detachables Two-Up or Solo Tour-Pak Mounting Rack and applicable Docking Hardware is required. Separate purchase of Tour-Pak Lock Kit P/N 53194-07 is required.

Solid Color	King Tour-Pak Luggage Fits '06-'08 models		King Tour-Pak Luggage Fits '07-'05 models	
	P/N	Price	P/N	Price
Black Cherry	53270-06BPS	\$799.95	53116-05BPS	\$824.95
Black Pearl	53270-06BPY	\$799.95	—	—
Crimson Red Sunglo	53270-08COZ	\$799.95	—	—
Dark Blue Pearl	53270-08CPC	\$799.95	—	—
Deep Cobalt	53270-06BXT	\$799.95	—	—
Vivid Black	53270-06DH	\$799.95	53116-97DH	\$749.95
White Gold Pearl	53270-08CGS	\$799.95	—	—



Notice: The prices appearing in this catalog are the manufacturer's suggested retail prices. Actual retail prices may vary.

# 808 COLOR SHOP

Color-Matched Accessories

## SADDLEBAG AND FAIRING LOWER SPEAKER HOUSINGS\*

Custom Color-Matched covers are shaped to accommodate Boom!™ Audio Saddlebag Lid and Fairing Lower Speakers. Speaker openings are formed to angle the speakers and direct the sound forward toward the rider and passenger. Installation reuses Original Equipment hinges, locks and mounting hardware.

### SADDLEBAG LID SPEAKERS – Available to fit:

Fits '14-later Touring models equipped with Boom!™ Audio Saddlebag Speaker Kit P/N 76000489.

Fits '06-'13 Touring models equipped with Boom! Audio Saddlebag Speaker Kit P/N 76000202.

### FAIRING LOWER SPEAKER BOXES – Available to fit:

Fits '14-later Touring models equipped with vented fairing lowers and Boom! Audio Fairing Lower Speaker Kit P/N 76000487.

Does not fit models with Twin-Cooled™ engines.

### \*Color-Matched Accessory Ordering Information:

Color, pinstripe and model information is provided for reference. When ordering Color-Matched Accessories, verify you have the correct accessory P/N by matching the paint suffix code (alpha characters at the end of the P/N) to the paint suffix code of painted service parts for the same bike. Please see your dealer for assistance matching paint codes.

NOTE: This product is a "Paint to Order" accessory. Please allow for an average of 5 weeks delivery for this item.



Solid Color	Boom!™ Saddlebag Lid–Left Fits '14-later models		Boom! Saddlebag Lid–Right Fits '14-later models		Boom! Fairing Lower Speaker Box Fits '14-later models	
	P/N	Price	P/N	Price	P/N	Price
Primed/Paintable	90201109	\$179.95	90201108	\$179.95	57100233	\$174.95
Amber Whiskey	90200827DST	\$309.95	90200826DST	\$309.95	76000497DST	\$279.95
Big Blue Pearl	90200827DJO	\$309.95	90200826DJO	\$309.95	76000497DJO	\$279.95
Birch White	90200827AV	\$309.95	90200826AV	\$309.95	76000497AV	\$279.95
Black Denim	90200827BYM	\$309.95	90200826BYM	\$309.95	76000497BYM	\$279.95
Black Magic	90200827DWV	\$349.95	90200826DWV	\$349.95	76000497DWV	\$279.95
Blackened Cayenne	90200827DSZ	\$309.95	90200826DSZ	\$309.95	76000497DSZ	\$279.95
Brilliant Silver	90200827BHT	\$309.95	90200826BHT	\$309.95	76000497BHT	\$279.95
Candy Orange	90200827DPU	\$309.95	90200826DPU	\$309.95	76000497DPU	\$279.95
Charcoal Pearl	90200827DTF	\$309.95	90200826DTF	\$309.95	76000497DTF	\$279.95
Charcoal Satin	90200827DUM	\$309.95	90200826DUM	\$309.95	76000497DUM	\$279.95
Daytona Blue	90200827DUA	\$339.95	90200826DUA	\$339.95	76000497DUA	\$299.95
Deep Jade Pearl	90200827DWF	\$349.95	90200826DWF	\$349.95	76000497DWF	\$279.95
Midnight Pearl	90200827DKJ	\$309.95	90200826DKJ	\$309.95	76000497DKJ	\$279.95
Morocco Gold	90200827DTC	\$309.95	90200826DTC	\$309.95	76000497DTC	\$279.95
Mysterious Red Sunglo	90200827DSW	\$309.95	90200826DSW	\$309.95	76000497DSW	\$279.95
Radioactive Green	90200827DWJ	\$349.95	90200826DWJ	\$349.95	76000497DWJ	\$279.95
Sand Camo Denim	90200827DSR	\$309.95	90200826DSR	\$309.95	76000497DSR	\$279.95
Sand Pearl	90200827DUN	\$309.95	90200826DUN	\$309.95	76000497DUN	\$279.95
Superior Blue	90200827DWC	\$309.95	90200826DWC	\$309.95	76000497DWC	\$279.95
Vivid Black	90200827DH	\$269.95	90200826DH	\$269.95	76000497DH	\$279.95
White Hot Pearl	90200827DJI	\$349.95	90200826DJI	\$349.95	76000497DJI	\$279.95

### CVO™ Primary Color

Burgundy Blaze ('15 FLTRUSE/'14 FLHTKSE)	90200827DQX	\$349.95	90200826DQX	\$349.95	—	—
Jupiter Blue ('14 FLHTKSE)	90200827DRS	\$349.95	90200826DRS	\$349.95	—	—
Star Dust Silver ('14 FLHTKSE)	90200827CZB	\$349.95	90200826CZB	\$349.95	—	—
Carbon Dust ('15 FLHTKSE)	90200827DXK	\$309.95	90200826DXK	\$309.95	—	—
Crushed Saaphire ('15 FLTRUSE)	90200827DQZ	\$309.95	90200826DQZ	\$309.95	—	—
Gold Rush ('15 FLHTKSE)	90200827DXN	\$309.95	90200826DXN	\$309.95	—	—
HC Mercury ('15 FLHXSE)	—	—	—	—	76000497DYO	\$279.95
Ultra Violet Blue ('15 FLHXSE)	—	—	—	—	76000497DYC	\$279.95
Palladium Silver ('15 FLHTKSE)	90200827DXM	\$309.95	90200826DXM	\$309.95	—	—
Scorching Yellow ('15 FLHXSE)	—	—	—	—	76000497DYA	\$279.95
Starfire Black ('15 FLHXSE)	—	—	—	—	76000497DLO	\$279.95

Solid Color	Boom! Saddlebag Lid–Left Fits '06-'13 models		Boom! Saddlebag Lid–Right Fits '06-'13 models	
	P/N	Price	P/N	Price
Primed/Paintable	90200612	\$149.95	90200613	\$149.95
Big Blue Pearl	90200614DJO	\$279.95	90200615DJO	\$279.95
Black Denim	90200614BYM	\$279.95	90200615BYM	\$279.95
Black Pearl	90200614BPY	\$279.95	90200615BPY	\$279.95
Candy Orange	90200614DPU	\$299.95	90200615DPU	\$299.95
Chrome Yellow Pearl	90200614DPR	\$299.95	90200615DPR	\$299.95
Ember Red Sunglo	90200614DJS	\$279.95	90200615DJS	\$279.95
Merlot Sunglo	90200614DCE	\$299.95	90200615DCE	\$299.95
Midnight Pearl	90200614DKJ	\$279.95	90200615DKJ	\$279.95
Red Hot Sunglo	90200614CYS	\$279.95	90200615CYS	\$279.95
Sedona Orange	90200614DGX	\$279.95	90200615DGX	\$279.95
Vivid Black	90200614DH	\$239.95	90200615DH	\$239.95
White Gold Pearl	90200614CGS	\$329.95	90200615CGS	\$329.95



### CVO™ Primary Color

Black Diamond	90200614CRP	\$329.95	90200615CRP	\$329.95
Maple Metallic	90200614DGM	\$499.95	90200615DGM	\$499.95



## SADDLEBAG FILLER STRIPS\*

For those who seek perfection, these kits fill in the gaps between the fender and the rear of the saddlebags, hiding the saddlebag mounting bracket. Choose between primed, highly polished chrome, or Color-Matched to your sheet metal and bags for a truly custom look.

**Available to fit:**

### Solid

Fits '14-later Touring models with hard saddlebags. Does not fit Street Glide®, Road Glide® or CVO™ models. Does not fit with accessory Saddlebag Guard Rails.

### Slotted

Fits '14-later Touring models with Hard Saddlebags and accessory saddlebag guard rails. Does not fit Street Glide, Road Glide or CVO models.

### Solid

Fits '09-'13 FLHT, FLHR and FLHTK models.

### Slotted

Fits '09-'13 Touring models equipped with Nostalgic Saddlebag Rail P/N 91286-09 and 91286-10.

### Solid

Fits '93-'08 Electra Glide® (except FLHX), '94-'08 FLHR (except FLHRCI with rear docking kit and FLHRS) and '93 FLHS models. (Will not fit models equipped with Nostalgic and Triple Rail Saddlebag Guard Rails or chrome Saddlebag Guard Kit P/N 90839-93A, 91216-97; Electra Glo™ Light Rails; Leather Saddlebags P/N 90652-94A, 90843-93; or with Fender Rail P/N 91019-92A. Does not fit '98-'08 FLTR.)

### \*Color-Matched Accessory Ordering Information:

Color, pinstripe and model information is provided for reference. When ordering Color-Matched Accessories, verify you have the correct accessory P/N by matching the paint suffix code (alpha characters at the end of the P/N) to the paint suffix code of painted service parts for the same bike. Please see your dealer for assistance matching paint codes.

NOTE: This product is a "Paint to Order" accessory.

Please allow for an average of 5 weeks delivery for this item.



**Saddlebag Filler Strips—Solid**  
Fits '14-later models

**Saddlebag Filler Strips—Slotted**  
Fits '14-later models

Solid Color	Saddlebag Filler Strips—Solid		Saddlebag Filler Strips—Slotted	
	P/N	Price	P/N	Price
Primed/Paintable	90201112	\$139.95	90201113	\$139.95
Chrome	90200873	\$169.95	90200875	\$169.95
Amber Whiskey	90200872DST	\$199.95	90200874DST	\$199.95
Big Blue Pearl	90200872DJO	\$199.95	90200874DJO	\$199.95
Birch White	90200872AV	\$199.95	90200874AV	\$199.95
Black Magic	90200872DWV	\$199.95	90200874DWV	\$199.95
Blackened Cayenne	90200872DSZ	\$199.95	90200874DSZ	\$199.95
Brilliant Silver	90200872BHT	\$199.95	90200874BHT	\$199.95
Candy Orange	90200872DPU	\$199.95	90200874DPU	\$199.95
Charcoal Pearl	90200872DTF	\$199.95	90200874DTF	\$199.95
Daytona Blue	90200872DUA	\$229.95	90200874DUA	\$229.95
Deep Jade Pearl	90200872DWF	\$199.95	90200874DWF	\$199.95
Midnight Pearl	90200872DKJ	\$199.95	90200874DKJ	\$199.95
Morocco Gold Pearl	90200872DTC	\$199.95	90200874DTC	\$199.95
Mysterious Red Sunglo	90200872DSW	\$199.95	90200874DSW	\$199.95
Radioactive Green	90200872DWJ	\$199.95	90200874DWJ	\$199.95
Sand Pearl	90200872DUN	\$199.95	90200874DUN	\$199.95
Superior Blue	90200872DWC	\$199.95	90200874DWC	\$199.95
Vivid Black	90200872DH	\$199.95	90200874DH	\$199.95
White Hot Pearl	90200872DJI	\$199.95	90200874DJI	\$199.95



**Saddlebag Filler Strips—Solid**  
Fits '09-'13 models

**Saddlebag Filler Strips—Slotted**  
Fits '09-'13 models

**Saddlebag Filler Strips—Slotted**  
Fits '93-'08 models

Solid Color	Saddlebag Filler Strips—Solid		Saddlebag Filler Strips—Slotted		Saddlebag Filler Strips—Slotted	
	P/N	Price	P/N	Price	P/N	Price
Primed/Paintable	91614-10BEO	\$134.95	91741-10BEO	\$134.95	45898-10BEO	\$134.95
Chrome	91422-09	\$169.95	91670-09	\$169.95	45898-98	\$169.95
Anniversary Vintage Bronze	91614-13DPY	\$189.95	91741-13DPY	\$189.95	—	—
Big Blue Pearl	91614-12DJO	\$179.95	—	—	—	—
Candy Orange	91614-13DPU	\$179.95	—	—	—	—
Chrome Yellow Pearl	91614-13DPR	\$179.95	—	—	—	—
Dark Candy Root Beer	91614-10DID	\$179.95	—	—	—	—
Ember Red Sunglo	91614-12DJS	\$179.95	91741-12DJS	\$179.95	—	—
Flame Blue Pearl	91614-09CWA	\$179.95	—	—	—	—
Merlot Sunglo	91614-10DCE	\$189.95	—	—	—	—
Midnight Pearl	91614-12DKJ	\$179.95	91741-12DKJ	\$179.95	—	—
Tequila Sunrise	91614-12DKO	\$189.95	—	—	—	—
Vivid Black	91614-09DH	\$179.95	91741-09DH	\$179.95	45898-08DH	\$179.95

Notice: The prices appearing in this catalog are the manufacturer's suggested retail prices. Actual retail prices may vary.

# 810 COLOR SHOP

Color-Matched Accessories

## COLOR-MATCHED STRETCHED SADDLEBAG BOTTOMS\*

Add the long low "slammed" look to your Touring bike without compromising the suspension travel and ride height. These Stretched Saddlebag Bottoms wrap around the exhaust to add visual length to the bike and hide the muffler bracket and hanger from view. Stretched Bottoms are predrilled to accept your existing saddlebag lids and latches. Simply attach the extended saddlebag bottom to your saddlebag lids with the included hardware and install on the bike like the original bags.

### Available to fit:

Fits '14-later Touring models with Color-Matched Hard Saddlebags.

Fits '93-'13 Touring models with Color-Matched Hard Saddlebags.

### \*Color-Matched Accessory Ordering Information:

Color, pinstripe and model information is provided for reference. When ordering Color-Matched Accessories, verify you have the correct accessory P/N by matching the paint suffix code (alpha characters at the end of the P/N) to the paint suffix code of painted service parts for the same bike. Please see your dealer for assistance matching paint codes.

NOTE: This product is a "Paint to Order" accessory. Please allow for an average of 5 weeks delivery for this item.



Stretched Saddlebag Bottoms  
Fits '14-later models

Stretched Saddlebag Bottoms  
Fits '93-'13 models

Solid Color	Inner/Outer Pinstripe	P/N	Price	P/N	Price
Primed/Paintable	—	90201107	\$1,099.95	92003-10BDK	\$1,099.95
Amber Whiskey	—	90201078DST	\$1,299.95	—	—
Big Blue Pearl	—	90201078DJO	\$1,299.95	92003-12DJO	\$1,299.95
Black Denim	—	90201078BYM	\$1,299.95	92003-10BYM	\$1,299.95
Black Magic/Graphics	—	90201196DWV	\$1,399.95	—	—
Black Pearl	—	—	—	92003-10BPY	\$1,299.95
Brilliant Silver	—	90201078BHT	\$1,299.95	—	—
Candy Orange	—	—	—	92003-13DPU	\$1,299.95
Charcoal Pearl	—	90201078DTF	\$1,299.95	—	—
Charcoal Satin	—	90201078DUM	\$1,299.95	—	—
Chrome Yellow Pearl	—	—	—	92003-13DPR	\$1,299.95
Daytona Blue/Graphics	—	90201193DUA	\$1,299.95	—	—
Ember Red Sunglo	—	—	—	92003-12DJS	\$1,299.95
Merlot Sunglo	—	—	—	92003-10DCE	\$1,299.95
Midnight Pearl	—	—	—	92003-12DKJ	\$1,299.95
Mysterious Red Sunglo	—	90201078DSW	\$1,299.95	—	—
Radioactive Green/Graphics	—	90201196DWJ	\$1,399.95	—	—
Sedona Orange	—	—	—	92003-10DGX	\$1,299.95
Superior Blue	—	90201078DWC	\$1,299.95	—	—
Tequila Sunrise	—	—	—	92003-12DKO	\$1,299.95
Vivid Black	—	90201078DH	\$1,299.95	92003-10DH	\$1,299.95
Amber Whiskey (FLXS/FLTRXS)	Charcoal Metallic	90201088DSV	\$1,349.95	—	—
Black Denim (FLXS/FLTRXS)	Medium Red	90201088DBN	\$1,349.95	—	—
Blackened Cayenne (FLXS)	Burgundy	90201088DTB	\$1,349.95	—	—
Brilliant Silver (FLHR)	Medium Silver	90201093BJN	\$1,349.95	—	—
Brilliant Silver (FLXS)	Medium Silver	90201088DZC	\$1,349.95	—	—
Charcoal Pearl (FLXS)	Black	90201088DTH	\$1,349.95	—	—
Deep Jade Pearl (FLXS)	Lt Green	90201088DWP	\$1,349.95	—	—
Morocco Gold (FLXS)	Pale Gold	90201088DTE	\$1,349.95	—	—
Morocco Gold Pearl	Pale Gold/Pale Gold	90201093DTD	\$1,349.95	—	—
Mysterious Red Sunglo (FLXS)	Burgundy	90201088DSY	\$1,349.95	—	—
Mysterious Red Sunglo	Medium Red/Burgundy	90201093DSX	\$1,349.95	—	—
Sand Camo Denim (FLXS)	Tan	90201088DTR	\$1,349.95	—	—
Superior Blue	Blue/Medium Silver	90201093DWK	\$1,349.95	—	—
Superior Blue (FLTRXS)	Blue	90201088DWM	\$1,349.95	—	—
Vivid Black (FLXS/FLTRXS)	Medium Silver	90201088DBX	\$1,349.95	—	—
Vivid Black	Medium Silver/Medium Silver	90201093BHY	\$1,349.95	—	—

Solid Color/Panel	Inner/Outer Pinstripe	P/N	Price	P/N	Price
Amber Whiskey/Brilliant Silver	Burgundy/Pale Gold	90201093DTP	\$1,399.95	—	—
Big Blue Pearl/Vivid Black	Dark Blue/Medium Silver	90201093DJQ	\$1,399.95	—	—
Brilliant Silver Pearl/Vivid Black	Med Red/Med Silver	90201093DWY	\$1,399.95	—	—
Deep Jade Pearl/Vivid Black	Lt Green/Pale Gold	90201093DXD	\$1,399.95	—	—
Mysterious Red/Blackened Cayenne Sunglo	Camo Tan/Medium Red	90201093DTI	\$1,399.95	—	—
Sand Pearl/Canyon Brown	Burgundy/Amber Gold	90201093DUB	\$1,399.95	—	—

Notice: The prices appearing in this catalog are the manufacturer's suggested retail prices. Actual retail prices may vary.



**COLOR-MATCHED TOUR-PAK® AND SADDLEBAG LID SPOILERS**

Aero styling and a practical addition to rear visibility. Color-Matched spoilers feature bright fast-acting LED lamps that get you noticed.

See page 402 for model fitment and installation requirements.



Solid Color	Tour-Pak Spoiler Fits '14-later models.		Saddlebag Lid Spoiler Fits '14-later models.		Tour-Pak Spoiler Fits '09-'13 FLHR/T/X/XXX models.		Saddlebag Lid Spoiler Fits '09-'13 FLHR/T/X/XXX models	
	Part #	Price	Part #	Price	Part #	Price	Part #	Price
Primed/Paintable	57200086BDK	\$179.95	57200087BDK	\$149.95	53149-99	\$204.95	58606-99	\$204.95
Amber Whiskey	57200086DST	\$179.95	57200087DST	\$149.95	—	—	—	—
Anniversary Vintage Bronze	—	—	—	—	53149-13DPY	\$249.95	58606-13DPY	\$249.95
Big Blue Pearl	57200086DJO	\$179.95	57200087DJO	\$149.95	53149-12DJO	\$229.95	58606-12DJO	\$229.95
Birch White	57200086AV	\$179.95	57200087AV	\$149.95	—	—	—	—
Black Denim	57200086BYM	\$179.95	57200087BYM	\$149.95	53149-12BYM	\$229.95	58606-12BYM	\$229.95
Black Magic	57200086DWV	\$179.95	57200087DWV	\$149.95	—	—	—	—
Blackened Cayenne	57200086DSZ	\$179.95	57200087DSZ	\$149.95	—	—	—	—
Brilliant Silver	57200086BHT	\$179.95	57200087BHT	\$149.95	—	—	—	—
Candy Orange	57200086DPU	\$179.95	57200087DPU	\$149.95	53149-13DPU	\$229.95	58606-13DPU	\$229.95
Charcoal Pearl	57200086DTF	\$179.95	57200087DTF	\$149.95	—	—	—	—
Charcoal Satin	57200086DUM	\$179.95	57200087DUM	\$149.95	—	—	—	—
Chrome Yellow Pearl	—	—	—	—	53149-13DPR	\$229.95	—	—
Daytona Blue	57200086DUA	\$179.95	57200087DUA	\$149.95	—	—	—	—
Deep Jade Pearl	57200086DWF	\$179.95	57200087DWF	\$149.95	—	—	—	—
Ember Red Sunglo	—	—	—	—	—	—	—	—
Midnight Pearl	57200086DKJ	\$179.95	57200087DKJ	\$149.95	—	—	—	—
Merlot Sunglo	—	—	—	—	53149-10DCE	\$229.95	—	—
Morocco Gold	57200086DTC	\$179.95	57200087DTC	\$149.95	—	—	—	—
Mysterious Red Sunglo	57200086DSW	\$179.95	57200087DSW	\$149.95	—	—	—	—
Radioactive Green	57200086DWJ	\$179.95	57200087DWJ	\$149.95	—	—	—	—
Sand Camo Denim	57200086DSR	\$179.95	57200087DSR	\$149.95	—	—	—	—
Sand Pearl	57200086DUN	\$179.95	57200087DUN	\$149.95	—	—	—	—
Superior Blue	57200086DWC	\$179.95	57200087DWC	\$149.95	—	—	—	—
Tequila Sunrise	—	—	—	—	53149-12DKO	\$229.95	58606-12DKO	\$229.95
Vivid Black	57200086DH	\$179.95	57200087DH	\$149.95	53149-99DH	\$229.95	58606-99DH	\$229.95
White Hot Pearl	57200086DJI	\$179.95	57200087DJI	\$149.95	—	—	—	—

**CVO™ Primary Color**

Atomic Orange ('13 FLTRXSE)	—	—	—	—	53149-13DRL	\$299.95	—	—
Tribal Orange ('14 FLHRSE)	57200086DQI	\$179.95	57200087DQI	\$149.95	—	—	—	—
Titanium Dust ('14 FLHRSE)	57200086DEA	\$179.95	57200087DEA	\$149.95	—	—	—	—
Sherwood Pearl ('14 FLHRSE)	57200086DUD	\$179.95	57200087DUD	\$149.95	—	—	—	—
Burgundy Blaze ('15 FLTRUSE)	57200086DQX	\$179.95	57200087DQX	\$149.95	—	—	58606-13DQX	\$249.95
Jupiter Blue ('14 FLHTKSE)	57200086DRS	\$179.95	57200087DRS	\$149.95	—	—	—	—
Star Dust Silver ('14 FLHTKSE)	57200086CZB	\$179.95	57200087CZB	\$149.95	—	—	—	—
Carbon Dust ('15 FLHTKSE)	57200086DXK	\$179.95	57200087DXK	\$149.95	—	—	—	—
Crushed Sapphire ('15 FLTRUSE)	57200086DQZ	\$179.95	57200087DQZ	\$149.95	—	—	—	—
Gold Rush ('15 FLHTKSE)	57200086DXN	\$179.95	57200087DXN	\$149.95	—	—	—	—
HC Mercury ('15 FLHXSE)	57200086DYO	\$179.95	57200087DYO	\$149.95	—	—	—	—
Ultra Violet Blue ('15 FLHXSE)	57200086DYC	\$179.95	57200087DYC	\$149.95	—	—	—	—
Palladium Silver ('15 FLHTKSE)	57200086DXM	\$179.95	57200087DXM	\$149.95	—	—	—	—
Scorching Yellow ('15 FLHXSE)	57200086DYA	\$179.95	57200087DYA	\$149.95	—	—	—	—
Starfire Black ('15 FLHXSE)	57200086DLO	\$179.95	57200087DLO	\$149.95	—	—	—	—
Diamond Dust	—	—	—	—	53149-13DLE	\$249.95	58606-13DLE	\$249.95
Black Diamond	—	—	—	—	53149-11CRP	\$249.95	58606-11CRP	\$249.95
Dark Slate	—	—	—	—	53149-12DDX	\$249.95	58606-12DDX	\$249.95
Hot Citrus	—	—	—	—	53149-12DED	\$249.95	58606-12DED	\$249.95
Obsidian	—	—	—	—	—	—	58606-13DRJ	\$249.95
Roman Gold	—	—	—	—	53149-13DHZ	\$299.95	58606-13DHZ	\$299.95

Notice: The prices appearing in this catalog are the manufacturer's suggested retail prices. Actual retail prices may vary.

# 812 COLOR SHOP

## Spoilers

### A. SPORTSTER® FRONT SPOILER\*

The wedge shape of the spoiler accents the lean and narrow look of the Sportster® model. Injection-molded from high-impact material and available Primed or Vivid Black finishes. Kit includes all mounting hardware.

Fits '04-later XL models (except '15-later models with ABS). Will not fit with Engine Guards, Boom!™ Audio Cruiser Amp and Speakers or Down Tube Bags.

<b>58882-04BDK</b>	Primed.	<b>\$139.95</b>
<b>58882-04DH</b>	Vivid Black.	<b>\$219.95</b>

### B. DYNA® FRONT SPOILER\*

With a scooped shape designed to accent the long, lean Dyna® models, this sporty custom addition is injection-molded from high-impact materials. Available Primed or Vivid Black finishes. Includes all mounting hardware.

#### Without Polished Insert

Fits '91-'03 Dyna models. Works with Engine Guard P/N 49007-90A on FXD, FXDL and FXDB models. Will fit with Chrome Voltage Regulator Cover P/N 74577-97. Will not fit on FXDWG, FXDX, FXDXT and FXDS models with Engine Guard P/N 49010-93. Will not fit '96-'03 California models equipped with an evaporative canister. Does not fit with Dyna Leather Tool Roll P/N 91714-97A.

<b>58593-97</b>	Primed.	<b>\$134.95</b>
-----------------	---------	-----------------

#### With Polished Insert

Fits '06-later Dyna models (except FLD). Will fit with Chrome Voltage Regulator Cover P/N 74667-06. Does not fit with engine guards. Does not fit California models equipped with evaporative emissions canister. Does not fit with Dyna Tool Roll P/N 91714-97A. Will not fit with Oil Cooler Kits.

<b>58042-08BDK</b>	Primed.	<b>\$154.95</b>
<b>58042-08DH</b>	Vivid Black.	<b>\$224.95</b>

Fits '95-'05 Dyna models. Will fit with Chrome Voltage Regulator Cover P/N 74577-97 or 74593-04. Fits with Engine Guard P/N 49007-90A on FXD, FXDL and FXDB models. Will not fit FXDWG, FXDX, FXDXT and FXDS models equipped with Engine Guard P/N 49010-93. Will not fit California models equipped with an evaporative emission canister. Does not fit with Dyna Tool Roll P/N 91714-97A.

<b>58042-04BDK</b>	Primed.	<b>\$159.95</b>
<b>58042-04DH</b>	Vivid Black.	<b>\$229.95</b>

### C. SOFTAIL® FRONT SPOILER\*

This front spoiler is made from injection-molded, high-impact composite materials and styled with a racy, custom appearance. Includes the necessary hardware for quick and easy installation.

Fits '07-'13 FX Softail®, FLSTSB and FLSTF models with oval voltage regulator. Will not fit models equipped with ABS, Premium Oil Cooler Kit P/N 26157-07 and 26136-05 or Chrome Voltage Regulator Cover. Will not fit with engine guards or ABS equipped vehicles.

<b>57040-08</b>	Primed.	<b>\$159.95</b>
<b>57040-08DH</b>	Vivid Black.	<b>\$289.95</b>

Fits '01-'06 FX Softail and FLSTF models with oval voltage regulator. Will not fit models equipped with ABS, Premium Oil Cooler Kit P/N 26157-07, 26136-05 or Chrome Voltage Regulator Cover. Will not fit with engine guards.

<b>57040-01</b>	Primed.	<b>\$169.95</b>
<b>57040-01DH</b>	Vivid Black.	<b>\$299.95</b>
<b>57101-01</b>	Chrome.	<b>\$199.95</b>



A. SPORTSTER FRONT SPOILER – VIVID BLACK



B. DYNA FRONT SPOILER WITH POLISHED INSERT – VIVID BLACK



B. DYNA FRONT SPOILER WITHOUT POLISHED INSERT – PRIMED (CUSTOM PAINTED)



C. SOFTAIL FRONT SPOILER – CHROME



C. SOFTAIL FRONT SPOILER – PRIMED (CUSTOM PAINTED)

\*NOTE: This product is a "Paint to Order" accessory. Please allow for an average of 5 weeks delivery for this item.

Notice: The prices appearing in this catalog are the manufacturer's suggested retail prices. Actual retail prices may vary.





D. SOFTAIL BULLET FRONT SPOILER – PRIMED (CUSTOM PAINTED)

**D. SOFTAIL® BULLET FRONT SPOILER\***

Add a long, lean and stretched look without modifying the frame. The deep chin spoiler flows into side rails that cover the frame tubes all the way back to the swingarm. Easy-to-install, this kit contains all necessary mounting hardware.

Fits '07-'13 FX Softail® models and '08-'13 FLSTF and FLSTFB models. Will not fit with Premium Oil Cooler Kit P/N 26157-07 or 26136-05. Will not fit with engine guards or ABS-equipped vehicles.

<b>57039-08BDK</b>	Primed.	<b>\$429.95</b>
<b>57039-08DH</b>	Vivid Black.	<b>\$519.95</b>

Fits '01-'06 FX Softail models. Will not fit with Premium Oil Cooler Kit P/N 26157-07 or 26136-05. Will not fit with engine guards.

<b>57039-03BDK</b>	Primed.	<b>\$434.95</b>
<b>57039-03DH</b>	Vivid Black.	<b>\$524.95</b>
<b>57006-03</b>	Chrome.	<b>\$359.95</b>

**E. COLOR-MATCHED XR1200™ SEAT COWL**

Go solo in style. These easy-to-install covers smooth and enhance the race-inspired profile of the XR1200™ tail section. Simply remove the existing passenger pillion and pop on the form-fitting Seat Cowl to change the look. Cover lifts off to reveal additional storage space.

Fits '08-'13 XR1200 and XR1200X™ models. Will not fit models equipped with Luggage Rack P/N 53920-08.

<b>1. 51496-10BYM</b>	Black Denim.	<b>\$229.95</b>
<b>2. 51496-10BNR</b>	Mirage Orange Pearl.	<b>\$229.95</b>
<b>3. 51496-10DH</b>	Vivid Black.	<b>\$229.95</b>



D. SOFTAIL BULLET FRONT SPOILER – CHROME



E. COLOR-MATCHED XR1200 SEAT COWL

Notice: The prices appearing in this catalog are the manufacturer's suggested retail prices. Actual retail prices may vary.

# 814 COLOR SHOP

## Fenders

### A. FL SOFTTAIL® CLEAN FRONT FENDER

An empty canvas for customizers, this fender has no holes, mounts with existing hardware/brackets and is offered in primed finish.

**59054-96** **\$189.95**  
Fits '86-later FLS, FLSTC, FLSTN and FLSTF models.

### B. FL TOURING CLEAN FRONT FENDER

With no holes, this fender provides the starting point for customization. Offered in primed finish and ready to bolt onto existing brackets.

**59045-00B** **\$299.95**  
Fits '94-'13 FLHR and '89-'13 FLT and FLHT models.

### C. STREET STALKER® FRONT FENDER KIT\*

The smooth curves of the Street Stalker® Front Fender easily create a clean, custom front-end look. Made from high-impact, injection-molded composite materials. Includes mounting hardware.

Fits '86-later FL Softail® models (except Springer™). Also fits '00-later Touring models (except models with fairing lowers) with separate purchase of Fender Adaptor Kit P/N 59013-02A or P/N 58900085. Does not fit Trike models.

**59397-98** Primed. **\$134.95**  
**59397-03DH** Vivid Black. **\$199.95**

### D. FRONT FENDER ADAPTER KIT

Add a true custom style to your Touring model. This polished and chrome-plated Adapter Kit will allow you to install the smooth curving Fat Boy® or Street Stalker front fender on your Touring bike. Manufactured from 6061-T6 billet aluminum, this kit includes all necessary mounting hardware. See your Dealer for primed or Color-Matched fender options.

**58900085** **\$99.95**  
Fits '14-later Touring models. Does not fit Touring models equipped with fairing lowers. Does not fit Trike models.

**59013-02A** **\$84.95**  
Fits '00-'13 FLHT, FLHX, FLHTC, FLHTCU and FLHTK models. Does not fit Trike models.



A. FL SOFTTAIL CLEAN FRONT FENDER



B. FL TOURING CLEAN FRONT FENDER



C. STREET STALKER FRONT FENDER KIT – VIVID BLACK



D. FRONT FENDER ADAPTER KIT  
'14-LATER MODELS



D. FRONT FENDER ADAPTER KIT  
'14-LATER MODELS



D. FRONT FENDER ADAPTER KIT  
'00-'13 MODELS

\*NOTE: This product is a "Paint to Order" accessory. Please allow for an average of 5 weeks delivery for this item.

Notice: The prices appearing in this catalog are the manufacturer's suggested retail prices. Actual retail prices may vary.





**E. CHOPPED REAR FENDER KIT – SPORTSTER MODELS PRIMED (CUSTOM PAINTED)**

**E. CHOPPED REAR FENDER KIT – SPORTSTER® MODELS\***

Complete "bolt-on" fender kit includes everything you need to convert your '04-later Sportster® model to the chopped rear fender look. Available in Vivid Black or Primed finish, this kit can be installed with simple tools and requires no frame modifications or fabrication. The chopped fender eliminates the traditional tail lamp, and replaces the Original Equipment rear turn signals with "stop-turn-tail" lights for a clean, stripped-down appearance. All you need to add is a side mount or under-fender mount license plate bracket (*sold separately*).

NOTE: Laws regarding the location of the license plate vary from place to place. Please check with local authorities and obey all applicable laws and regulations.

Fits '07-'09 XL models. Stock on XL1200N and XL883N. Requires separate purchase of Side Mount License Plate Assembly P/N 60318-07.

<b>60236-09BEO</b>	Primed.	<b>\$419.95</b>
<b>60236-09DH</b>	Vivid Black.	<b>\$499.95</b>

Fits '04-'06 and '10-later XL models (except XL1200T). Stock on XL1200N, XL1200V, XL1200X and XL883N. Will not fit some International Specification '14-later XL883N (Iron 883) models with Original Equipment LED Turn Signals. See your dealer for details. Requires separate purchase of Side Mount License Plate Assembly P/N 60318-07, 60947-10 or 60972-10.

<b>60236-10BEO</b>	Primed.	<b>\$419.95</b>
<b>60236-10DH</b>	Vivid Black.	<b>\$499.95</b>

**F. BOBTAIL REAR FENDER KIT – DYNA® MODELS\***

Change the look and the attitude of your Dyna® motorcycle with a Bobtail Rear Fender. Standard on the Dyna Wide Glide® model. This sleek upturned fender adds style to the rear of your bike.

Fits '06-later FXD, FXDC and FXDL, '14-later FXDF and '06-'08 FXDB models. FXDF requires separate purchase of tail light assembly. Stock on '06-'08 FXDWG models. Does not fit '08-'13 FXDF and FXDFSE/2, '10-later FLD and FXDWG models. Requires separate purchase of Installation Kit P/N 69710-06.

<b>59925-06</b>	Primed.	<b>\$299.95</b>
<b>59925-06DH</b>	Vivid Black.	<b>\$399.95</b>

Also available:

**BOBTAIL REAR FENDER INSTALLATION KIT**

Required for installation of Bobtail Fender Kit on Dyna models.

<b>69710-06</b>		<b>\$249.95</b>
-----------------	--	-----------------

Fits '06-later FXD, FXDC and FXDL, '14-later FXDF and '06-'08 FXDB models. Stock on '06-'08 FXDWG models.

**G. LARGE CAPACITY SPORTSTER FUEL TANKS\***

Featuring the radical styling of the Sportster Custom motorcycle, this large fuel tank holds up to 4.5 gallons of fuel. Great for cross-country cruising, the tank is formed and painted as only Harley-Davidson® can.

<b>62732-07DH</b>	Vivid Black.	<b>\$649.95</b>
-------------------	--------------	-----------------

Fits '07-later XL models (except XL1200T). Installation Kit P/N 62999-07 is required for installation on models not originally equipped with Large Capacity Tank. Requires separate purchase of a seat compatible with a 4.5 gallon fuel tank. XL1200V and XL1200X models also require separate purchase of P/N 27067-07A.

<b>62732-04DH</b>	Vivid Black.	<b>\$649.95</b>
-------------------	--------------	-----------------

Fits '04-'06 XL models. Installation Kit P/N 62999-04 is required for installation on models not originally equipped with Large Capacity Tank. Will not fit with stock seat. Requires separate purchase of XL883C/XL1200C style seat.

Also available:

**SPORTSTER LARGE TANK INSTALLATION KIT (not shown)**

Required for installation of Large Capacity Fuel Tank on XL models.

<b>62999-07</b>		<b>\$129.95</b>
-----------------	--	-----------------

Fits '07-later XL models (except XL1200T). Kit includes Fuel Line Assembly, Fuel Pump Seal and docking hardware.

<b>62999-04</b>		<b>\$24.95</b>
-----------------	--	----------------

Fits '04-'06 XL883 STD, XL883L and XL1200R models.



**F. BOBTAIL REAR FENDER KIT – DYNA MODELS – VIVID BLACK**



**G. LARGE CAPACITY SPORTSTER FUEL TANK – VIVID BLACK (SHOWN WITH ACCESSORY CONSOLE)**

Notice: The prices appearing in this catalog are the manufacturer's suggested retail prices. Actual retail prices may vary.

# 816 COLOR SHOP

## Medallions & Decals

### A. FUEL TANK NAMEPLATE AND ADAPTER KITS

For those of you with nostalgia in mind, our popular fuel tank trims fit a wide selection of early models. In addition, we now offer adapter kits for later models. The adapter kits come with all necessary hardware for installation of fuel tank trim on later models. Adapter Kit Brackets are self-adhesive to accommodate most universal applications. All trim and adapter kits are sold in pairs.

**1. 61769-47T** Fits all '47-'50 models. **\$43.95**

**Adapter Kit for P/N 61769-47T**

**61783-92T** **\$23.95**  
Fits Fat Bob® fuel tanks (except '08-later Touring and Trike models).

**2. 61776-61T** Fits '61-'62 FL models. **\$48.95**

**Adapter Kit for P/N 61776-61T**

**61740-90T** **\$23.95**  
Fits Fat Bob fuel tanks (except '08-later Touring and Trike models).

**3. 61775-59T** Fits Fat Bob fuel tanks. **\$43.95**

**Adapter Kit for P/N 61775-59T**

**61742-93T** **\$23.95**  
Fits Fat Bob fuel tanks (except '08-later Touring and Trike models).

**4. 61769-40T** Fits '36-'46 Big Twin models. **\$43.95**

**Adapter Kit for P/N 61769-40T**

**61785-92T** **\$23.95**  
Fits Fat Bob fuel tanks (except '08-later Touring and Trike models).

**5. 61774-51T** **\$43.95**

Fits '51-'54 Big Twin and '52-'54 K models.

**Adapter Kit for P/N 61774-51T**

**61784-92T** **\$23.95**  
Fits Fat Bob fuel tanks (except '08-later Touring and Trike models).

**6. 61777-63T** Fits '63-'65 FL and XL models. **\$38.95**

**Adapter Kit for P/N 61777-63T**

**61782-91T** **\$23.95**  
Fits Fat Bob fuel tanks (except '08-later Touring and Trike models).

**7. 61771-66TB** **\$38.95**

Fits '66-'71 FL, XL and '71 FX models.

**Adapter Kit for P/N 61771-66TB**

**61741-93T** **\$23.95**  
Fits Fat Bob fuel tanks (except '08-later Touring and Trike models).

**8. 61814-55T** Chrome. **\$43.95**

Fits Fat Bob Fuel Tanks.

**Adapter Kit for P/N 61814-55T**

**61840-94T** **\$23.95**  
Fits Fat Bob fuel tanks (except '08-later Touring and Trike models).

### B. EAGLE FAIRING DECAL

Gives your fairing that custom look. Multi-colored. Made in the U.S.A.

**14093-84** Black Background. **\$39.95**  
Eagle decal fits '13-earlier FL, FLH and FLHT fairings.



A. FUEL TANK NAMEPLATE AND ADAPTER KITS



B. EAGLE FAIRING DECAL

Notice: The prices appearing in this catalog are the manufacturer's suggested retail prices. Actual retail prices may vary.





C. DECORATIVE MEDALLIONS

**C. DECORATIVE MEDALLIONS**

Display a touch of attitude. Ideal for use on plate-style sissy bar uprights and battery covers, the adhesive backing on these high-quality cast medallions allows easy installation on most flat surfaces. The medallions are available in black accented chrome or antique nickel finishes. The Oval Bar & Shield logo and the Bar & Shield with Wings medallions look great with Chrome Backrest Mount P/N 52527-01 and 52531-01.

<b>1. Skull – Antique Nickel</b>		
91720-02	3-5/8" x 3".	\$27.95
<b>2. Skull – Chrome</b>		
91718-02	3-5/8" x 3".	\$27.95
<b>3. Skull with Wings – Antique Nickel</b>		
91732-02	5" x 1-1/2".	\$27.95
<b>4. Skull with Wings – Chrome</b>		
91723-02	5" x 1-1/2".	\$27.95
<b>5. Bar &amp; Shield Logo with Wings – Chrome</b>		
91745-02	4" x 1-1/2".	\$19.95
<b>6. Oval with Bar &amp; Shield Logo – Chrome</b>		
91716-02	3-3/8" x 1-1/2".	\$19.95

**D. SELF-ADHESIVE MEDALLIONS AND SISSY BAR UPRIGHT INSERTS**

Works great on derby covers, timer covers, medallion plate-style sissy bar uprights and chrome battery covers.

<b>Made in U.S.A. Eagle</b>		
1. 99000-77	Large Medallion.	\$24.95
<b>Bar &amp; Shield Logo</b>		
2. 91815-85	Large Medallion.	\$27.95
3. 91816-85	Small Medallion.	\$19.95
<b>Eagle with Bar &amp; Shield Logo</b>		
4. 91811-85	Large Medallion.	\$27.95
5. 91810-85	Small Medallion.	\$19.95



D. SELF-ADHESIVE MEDALLIONS AND SISSY BAR UPRIGHT INSERTS

Notice: The prices appearing in this catalog are the manufacturer's suggested retail prices. Actual retail prices may vary.

# 818 COLOR SHOP

## Medallions & Decals

### A. "LIVE TO RIDE" LOGO MEDALLIONS

These self-adhesive medallions are made of durable ABS plastic, and look great on sissy bars, battery covers, Tour-Pak® luggage carriers, saddlebags, etc.

<b>99027-87T</b>	3.5" – Chrome.	<b>\$20.95</b>
<b>99028-87T</b>	2.5" – Chrome.	<b>\$18.95</b>
<b>99027-90T</b>	3.5" – Gold.	<b>\$25.95</b>
<b>99028-90T</b>	2.5" – Gold.	<b>\$26.95</b>

### B. DIAMOND ICE COLLECTION FLAT MEDALLIONS

Diamond Ice Medallions are designed for installation on flat surfaces and the self-adhesive backing holds the Bar & Shield shaped emblem firmly in place.

<b>92469-10</b>	Large. Approximate dimensions: Length 3.5"; Height 2.5".	<b>\$27.95</b>
<b>92468-10</b>	Small. Approximate dimensions: Length 1.625"; Height 1.25".	<b>\$22.95</b>

### C. SPECIAL EDITION MEDALLION

Special Edition Medallion with Harley-Davidson logo. Adhesive backing for easy installation.

Fits '96-'13 Electra Glide® inner fairing and other flat surfaces.

<b>14813-03</b>	Peace Officer – Nickel Finish.	<b>\$21.95</b>
<b>14814-03</b>	Firefighter – Brass Finish.	<b>\$21.95</b>

### D. METAL ADHESIVE-BACKED LOGO

All you do is choose the style you like, select a Timer or Derby Cover and affix the medallion to the cover. Works great on medallion, plate-style sissy bar uprights and chrome battery covers.

<b>99352-82Z</b>	Bar & Shield Logo. Universal.	<b>\$10.95</b>
------------------	-------------------------------	----------------

### E. DECALS

Use your imagination for the many uses of Genuine Harley-Davidson® Decals. A large variety of others in many different designs and colors are available through your Harley-Davidson Dealer. Ask your Dealer for more information.



A. "LIVE TO RIDE" LOGO MEDALLIONS – CHROME AND GOLD

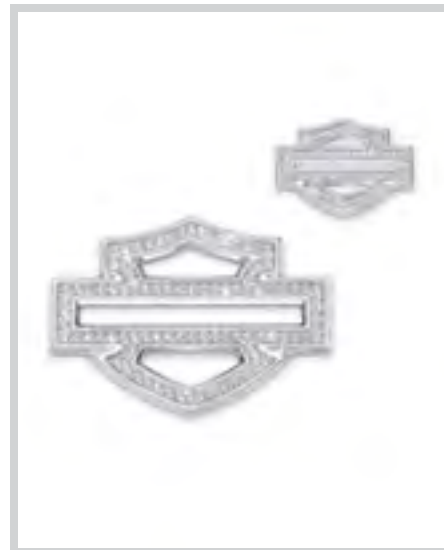

B. DIAMOND ICE COLLECTION FLAT MEDALLION – LARGE



C. SPECIAL EDITION MEDALLION – PEACE OFFICER AND FIREFIGHTER



D. METAL ADHESIVE-BACKED LOGO



E. DECALS

Notice: The prices appearing in this catalog are the manufacturer's suggested retail prices. Actual retail prices may vary.





**F. PERSONAL ACCENTS CONSOLE INSERT COLLECTIONS – RAISED SKULL**



**F. PERSONAL ACCENTS CONSOLE INSERT COLLECTIONS – VIVID BLACK**

**F. PERSONAL ACCENTS CONSOLE INSERT COLLECTIONS**

As a rider, there is probably no part of your bike you see more than your dash and tank console. And thanks to Personal Accents Inserts, it's also the easiest part of your bike to customize. Console inserts are available in a stylish assortment of finishes that blend with your personal direction.

Fits '08-'13 FLHR and FLHRC models.

**71973-08** Vivid Black. **\$54.95**

Fits '94-'07 FLHR (except FLHRS) models.

**71237-05** Vivid Black. **\$74.95**

Fits '89-'07 FLHS, FLTR, FLH, FLHT, FLHTC and FLTC models.

**71149-05** Flamed. **\$49.95**

**71370-05** Raised Skull. **\$49.95**

**71229-05** Vivid Black. **\$54.95**

Fits '08-'13 FLHX models.

**71902-08** Raised Skull. **\$29.95**

**71903-08** Vivid Black. **\$29.95**

Fits '00-later Softail® (except FXSTD, FXCW, FXCWC, FXSB, FXSBSE, FLS, FLSTSB, FLSTNSE, FXST-Aus and '09-later FLSTC) and '99-'03 FXDWG models.

**71337-05** Vivid Black. **\$74.95**

**71172-05** Flamed. **\$54.95**

**70928-07** Stacked Skulls. **\$54.95**

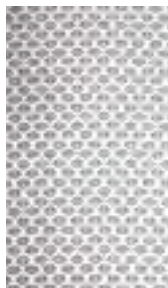

**Bar & Shield**



**Flamed**

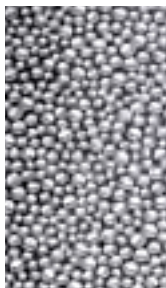

**Stacked Skulls**

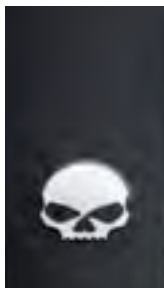

**Raised Skull**

**F. PERSONAL ACCENTS CONSOLE INSERT COLLECTIONS**



*Fits '08-'13 FLHR and FLHRC models*



*Fits '08-'13 FLHX models*



*Fits many '00-later Softail and '99-'03 FXDWG models.*



*Fits '94-'07 FLHR (except FLHRS) models*



*Fits '89-'07 FLHS, FLTR, FLH, FLHT, FLHTC and FLTC models*

**F. PERSONAL ACCENTS CONSOLE INSERT COLLECTIONS – TOURING AND SOFTAIL MODELS**

*Notice: The prices appearing in this catalog are the manufacturer's suggested retail prices. Actual retail prices may vary.*

GENUINE MOTOR PARTS & ACCESSORIES



2015

# GARAGE

While it's tempting to use "auto parts store" cleaning and service supplies, hold out for the real thing. Harley-Davidson® oils, filters, batteries and service parts are engineered for the unique surfaces and operating conditions your motorcycle will encounter.





## MORE THAN AN OIL CHANGE

Harley-Davidson® dealers will service your motorcycle with factory-approved methods and equipment. Dealership technicians are specially trained and use advanced technologies to properly diagnose and maintain your bike. Whether it's your first 1,000-mile checkup, 20,000-mile service or anything in between, your dealership should be your service destination.

### THE WELL-EQUIPPED GARAGE

Adventure always comes at a price, especially for a motorcycle. The sun, moisture, bugs and road debris can take their toll on the bike's external and internal finishes. But, if you have the right tools for fighting through miles and miles of the highway's abuse, you'll be more than ready to ride for years.

#### FLUIDS

Whether it's oil, brake fluid or Screamin' Eagle® SYN3™ Synthetic Motorcycle Lubricant, all Harley-Davidson® fluids are developed exclusively for use in Harley-Davidson motorcycles, making them a must-have in your garage.

#### FILTERS

Don't overlook the essentials. Harley-Davidson air and oil filters keep debris out of your engine and help keep it healthy. So replace them routinely and insist on using only the genuine article.

#### STORAGE

Premium motorcycle covers, bike lifts and wall-mounted detachable storage units protect your bike and keep your garage organized.

#### LOCKS

Secure your Harley with street-proven cables, anchors and locks designed specifically to deter and prevent motorcycle theft. Go one step further and add a factory security system or universal alarm for even more peace of mind.

#### TOOLS

Every bit as rugged as our motorcycles, Harley-Davidson tools and tool kits boast a compact, lightweight design developed specifically for use on your Harley.

#### BATTERIES

Genuine H-D® Batteries feature AGM technology for higher cold cranking amps, longer life and improved rechargeability.



## CLEANING TIPS FROM THE MOTOR COMPANY

We understand how important a clean ride is to you. That's why we've spent thousands of hours formulating cleaning and care products designed specifically for H-D® surfaces and finishes. Unlike common "auto parts store" brands, these products are designed to protect your investment and will work together without adverse reactions.

### CHECKLIST FOR COMMON CLEANING ISSUES:

- ☑ Before applying any protective or cosmetic product, you should always start off by washing your motorcycle with Sunwash® Bike Soap.
- ☑ Don't detail your bike in the direct light of the day. Sun-warmed clearcoat and hot surfaces may streak and swirl when drying.
- ☑ To soften melted-on boot marks and tar from exhaust pipes, apply Boot Mark Remover and let it set for a few minutes. Then scrape away the gunk with a Soft Cloth.
- ☑ The natural acid in bug splatter is damaging to surface finishes, so be sure to act quickly. Apply Bug Remover, wait a minute to soften the residue, and rinse away the debris.
- ☑ To remove adhesives, tar, tree sap and pollutants, dab on Glaze™ Poly Sealant, wait, then wipe it clean with a Soft Cloth.
- ☑ Is your leather looking dull? Black Leather Rejuvenator's pigmented formula restores the luster and Leather Protectant weatherproofs the surfaces.
- ☑ Whitewalls a little dirty? Apply Harley® Wheel & Tire Cleaner with the Soft Detailing Pad to make them gleam.
- ☑ To revive dull seats, inner fairings and plastic surfaces, mist on Trim Cleaner and wipe away the dust and grime.
- ☑ To protect plastic, painted, and chrome-plated surfaces, apply Glaze Poly Sealant. This cream combats fading and oxidation and its ultrafine leveling agent removes minor blemishes.
- ☑ Don't have time for a complete detailing session? Use Harley Gloss or Harley Spray Cleaner & Polish for quick jobs between applications of Glaze Poly Sealant.



▶ For a video view, log on to: [h-d.com/partsvideos](http://h-d.com/partsvideos)

# 824 GARAGE

Surface Care – Clean

## A. QUICK WASH

Fast and easy to use, Quick Wash is tough on dirt, oil and bugs, but gentle on other surfaces. This all-over bike cleaner is safe for use on all surfaces of your motorcycle and does not strip wax, corrode fasteners or spokes or stain leather and vinyl seats and saddlebags. Just spray it on and hose it off. Quick Wash gets into hard-to-reach spaces and cleans without scrubbing. Sheeting action rinses clean and prevents spotting. Available in easy-to-handle trigger pump bottles and convenient refill containers.

16 fl oz (473 ml) Spray Bottle.

<b>93600011</b>	U.S.	<b>\$7.95</b>
<b>93600071</b>	International.	<b>\$7.95</b>

32 fl oz (946 ml) Trigger Bottle.

<b>93600012</b>	U.S.	<b>\$15.95</b>
-----------------	------	----------------

1 gallon (3.79 L) Refill Bottle.

<b>93600013</b>	U.S.	<b>\$42.95</b>
-----------------	------	----------------



A. QUICK WASH

## B. SUNWASH® BIKE SOAP

This revolutionary cleaner lets riders wash their bikes where they want to – in the sun. Most bike wash products can be used only on cool days or in the shade. Sunwash® Bike Soap has a unique sheeting action that prevents hard water spots, and rinses clean even on hot days in the sun. Safe for use on all vehicle surfaces including denim paint. Biodegradable.

8 fl oz (236 ml) Bottle.

<b>93600023</b>	U.S.	<b>\$6.95</b>
<b>93600077</b>	International.	<b>\$7.95</b>

## C. SPRAY CLEANER & POLISH

Keep your bike clean, even when you are away from home. Aerosol waterless quick cleaner/detailer is the perfect choice when the motorcycle is too clean to wash but too dirty to ride. Safe for use on metal, painted, plastic and windshield surfaces, this cleaning spray dissolves road grime and bugs for quick and easy cleaning and detailing. The spray floats dirt off the motorcycle, reduces static attraction to dust and leaves the surface with a great shine and UV protection.

11 oz (311 g) Aerosol Can.

<b>93600029</b>	U.S.	<b>\$7.95</b>
<b>93600084</b>	International.	<b>\$7.95</b>

Also available:

### SPRAY CLEANER & POLISH + MICROFIBER KIT

The perfect on-the-road cleaning companion. Kit contains:

- *Spray Cleaner & Polish* aerosol waterless quick cleaner/detailer floats dirt and dust off the surface for a quick and easy cleanup.
- *Microfiber Detailing Cloth* is soft and durable for detailing, cleaning or buffing. The washable cloth can be used wet or dry and is safe for use on all surfaces and finishes.

<b>93600108</b>	Domestic.	<b>\$11.95</b>
<b>93600109</b>	International.	<b>\$13.95</b>



B. SUNWASH BIKE SOAP



C. SPRAY CLEANER & MICROFIBER KIT

## D. BUG REMOVER

Remove bugs with little effort. Bugs have natural acids in their systems that can prove to be very damaging to motorcycle finishes if not removed. Bug Remover melts away bugs and is safe for use on metal, painted and plastic surfaces, including H-D® windshields. Biodegradable.

16 fl oz (473 ml) Spray Bottle.

<b>93600022</b>	U.S.	<b>\$8.95</b>
<b>93600075</b>	International.	<b>\$9.95</b>

Single-Use Wipe.

<b>97400-10</b>	Qty-1.	<b>\$1.49</b>
-----------------	--------	---------------



D. BUG REMOVER



D. BUG REMOVER – INDIVIDUAL WIPES

Notice: The prices appearing in this catalog are the manufacturer's suggested retail prices. Actual retail prices may vary.





**E. WHEEL & TIRE CLEANER**



**F. DENIM PAINT CLEANER**

**E. WHEEL & TIRE CLEANER**

The road provides plenty of nasty elements that can be potentially damaging to the finish of motorcycle wheels. Wheel & Tire Cleaner safely removes brake dust and road grime from wheels, tires and whitewalls in seconds. Also recommended for cleaning Harley-Davidson® black-coated exhaust pipes and mufflers. Biodegradable.

16 fl oz (473 ml) Spray Bottle.

<b>93600024</b>	U.S.	<b>\$8.95</b>
<b>93600076</b>	International.	<b>\$9.95</b>

**F. DENIM PAINT CLEANER**

Specially formulated for denim paint, this handy quick detailer cleans and protects the silky matte finish. Cleaner won't streak or leave residue. Just spray and gently wipe away oils, fingerprints and dust. Compatible with all surfaces on Harley-Davidson motorcycles, this formula cleans without buffing, so you can avoid "polishing" the denim surface. Heavily soiled surfaces should be washed with Sunwash® Bike Soap and water before application.

16 fl oz (473 ml) Spray Bottle.

<b>93600064</b>	U.S.	<b>\$8.95</b>
<b>93600078</b>	International.	<b>\$8.95</b>

**G. SEAT, SADDLEBAG & TRIM CLEANER**

The perfect quick detailer for vinyl, leather and plastic surfaces, this one-step treatment cleans and refreshes without leaving a greasy residue. Just mist on and wipe away the accumulated dust and grime that dulls the finish. Ideal for use on inner fairings, dash panels, seats and saddlebags, this spray cleaner dries to a healthy satin shine and contains no waxes or other solvents that can dull the surface of vinyl and plastic.

**93600010** 8 fl oz (236 ml) Spray Bottle. **\$9.95**

**H. BOOT MARK REMOVER**

Return the shine to your chrome exhaust. Formulated to break down rubber marks and road tar, Boot Mark Remover exhaust cleaner is applied directly to the soiled area. Just cover the target area with gel when the exhaust is cool and let it do its thing. Scrub and wipe away the residue, then rinse clean. Ideal for removing boot marks, asphalt resin, baked-on insects and melted plastic bags. Resealable applicator cap.

4 fl oz (118 ml) Bottle.

<b>93600001</b>	U.S.	<b>\$8.95</b>
<b>93600069</b>	International.	<b>\$8.95</b>

**I. CHROME CLEAN & SHINE**

Professional strength nonabrasive cleaner is formulated to ensure maximum shine on chrome-plated surfaces. The detergent-resistant formula is easy to apply and can be buffed to a bright, long-lasting finish. Can also be used to clean decorative brushed aluminum/stainless steel surfaces.

4 oz (113 g) Container.

<b>93600031</b>	U.S.	<b>\$9.95</b>
<b>93600082</b>	International.	<b>\$9.95</b>

**J. WINDSHIELD WATER REPELLANT**

Approved for use on Harley-Davidson motorcycle windshields. Enhance visibility during wet weather riding. Reduces the surface tension of water, allowing the water to bead and dissipate from the windshield by the airflow during riding. The convenient dispensing container includes 10 disposable wipes for easy application of the treatment. You can repeat application of the treatment as necessary. Not recommended for use on face shields. Not for use as an anti-fog product.

**93600032** 10 Wipes. **\$7.95**



**I. CHROME CLEAN & SHINE**



**J. WINDSHIELD WATER REPELLANT**

# 826 GARAGE

Surface Care – Detail

## A. GLOSS DETAILER

This easy-to-apply mist produces the highest possible gloss finish in the shortest amount of time. Formulated to enhance luster and provide UV protection between waxes, this nonabrasive quick detailer can be applied to paint, clear coat, chrome, powder coat, windshields, vinyl and plastic. Gloss Detailer contains no waxes, silicones, oils or hydrocarbon solvents and will not remove Glaze Poly Sealant. Biodegradable.

16 fl oz (473 ml) Spray Bottle.

**93600062** U.S. **\$9.95**

**93600073** International. **\$10.95**

1 Gallon Bottle.

**93600085** Global. **\$29.95**

Single-Use Wipe.

**97401-10** Qty-1. **\$1.49**

## B. SCRATCH & SWIRL REPAIR

Formulated to remove fine scratches and swirl marks from gloss paint, this unique compound contains nonrigid abrasives that provide good initial leveling action on clear coat and become less aggressive while being buffed. This staging of grit size provides the benefits of a several step process in one convenient bottle and leaves your clear coat with a "new bike" shine. Biodegradable.

8 fl oz (236 ml) Bottle.

**93600025** U.S. **\$7.95**

**93600074** International. **\$7.95**

## C. ENGINE BRIGHTENER

Make your engine look new again. Engine Brightener refreshes and rejuvenates tired wrinkle black finishes on engine cases, cylinder fins, covers or anywhere else the color has faded or lost its luster. Formulated with high-temperature silicon polymer, this detergent-resistant finish restorer cleans deep into the wrinkle black surface and "moisturizes" the finish to return the original satin sheen. Just spray it on, let it soak in and wipe away for a fresh look.

11 oz (311 g) Aerosol Can.

**93600002** U.S. **\$15.95**

**93600068** International. **\$15.95**

## D. BARE METAL POLISH

Professional strength micro-abrasive polish is formulated to remove oxidation and refurbish metal motorcycle parts that have lost their original finish. Recommended for use on polished aluminum or polished stainless steel surfaces that are not clear coated. Not for use on painted, chromed or plated surfaces or decorative brushed aluminum or stainless steel finishes.

4 oz (113 g) Container.

**93600028** U.S. **\$9.95**

**93600083** International. **\$9.95**

## E. BLACK LEATHER REJUVENATOR

Black Leather Rejuvenator puts new life back into faded black leather seats and saddlebags. To re-color and condition weathered leather, just clean the surface and apply the treatment with a Disposable Detailing Soft Cloth. Wipe off the excess, buff the leather surfaces to the desired shine, and your leather looks like new. For lasting weather protection, follow the application with H-D® Leather Protectant.

4 oz (113 g) Container.

**93600033** U.S. **\$7.95**

**93600081** International. **\$7.95**



A. GLOSS DETAILER



A. GLOSS DETAILER – INDIVIDUAL WIPES



B. SCRATCH & SWIRL REPAIR



C. ENGINE BRIGHTENER



D. BARE METAL POLISH



E. BLACK LEATHER REJUVENATOR

Notice: The prices appearing in this catalog are the manufacturer's suggested retail prices. Actual retail prices may vary.





**F. GLAZE POLY SEALANT**



**G. LEATHER PROTECTANT**

**F. GLAZE POLY SEALANT**

Three products in one bottle. A durable, breathable, clear poly sealant with UV protection that protects against fading and the oxidizing effects of acid rain and harsh airborne pollutants. An ultrafine leveling agent that removes fine scratches and minor blemishes in clear coat finishes. And a cleaner tough enough to handle tar, tree sap, stains and pollutants. Glaze Poly Sealant is easy to apply and hand buff for a deep, reflective finish. For use on all chrome-plated and gloss painted surfaces. Not for use on brake discs or denim, semi-gloss or wrinkle-finish surfaces. Biodegradable.

8 fl oz (236 ml) Bottle.

<b>93600026</b>	U.S.	<b>\$7.95</b>
<b>93600079</b>	International.	<b>\$7.95</b>

**G. LEATHER PROTECTANT**

Leather Protectant offers the most effective weatherproofing and preservative action for leather saddlebags, tank panels, gear and apparel. Specially formulated for smooth, oil-tanned leather.

6 oz (170 g) Container.

<b>93600034</b>	U.S.	<b>\$7.95</b>
<b>93600080</b>	International.	<b>\$7.95</b>

**H. BARE ALUMINUM WHEEL PROTECTANT – INDIVIDUAL WIPES**

Bare Aluminum Wheel Protectant provides superior corrosion control for bare aluminum surfaces by forming a protective polymeric coating. The long-lasting formula is detergent and UV-resistant and is compatible with Harley-Davidson approved painted surfaces. Ideal for bare aluminum machined wheels. Should not be applied to mirror-polished surfaces or areas that will achieve operating temperatures greater than 300 degrees Fahrenheit.

<b>99846-10</b>	One Single-Use Wipe.	<b>\$2.95</b>
-----------------	----------------------	---------------

**I. WINDSHIELD CLEANER – INDIVIDUAL WIPES**

Windshield Cleaner is approved for use on Harley-Davidson® windshields and removes water spots and grime that can obstruct your view. Single-use disposable wipe reduces the chance of scratching the shield, and cleans better than the typical grit-laden gas station squeegee or paper towel.

<b>93600067</b>	One Single-Use Wipe.	<b>\$1.49</b>
-----------------	----------------------	---------------

**J. TIRE LETTERING PEN**

Enhance your tire sidewall lettering by applying White paint. Acrylic ester resin paint provides excellent water resistance with improved color and gloss retention. Pump action paint dispensing pen allows either outlining or filling the lettering. Tip can be shaped or trimmed to allow for customized paint flow.

<b>98625</b>	1/3 fl oz – White.	<b>\$9.95</b>
--------------	--------------------	---------------



**H. BARE ALUMINUM WHEEL PROTECTANT – INDIVIDUAL WIPES**



**I. WINDSHIELD CLEANER – INDIVIDUAL WIPES**



**J. TIRE LETTERING PEN**

*Notice: The prices appearing in this catalog are the manufacturer's suggested retail prices. Actual retail prices may vary.*

# 828 GARAGE

## Surface Care

### A. HARLEY® WASH BUCKET

The perfect way to keep your bike clean and your garage organized. This handy 3.5 gallon cleaning bucket features a removable Grit Guard® insert that keeps sponges and wash mitts away from the dirt particles that settle to the bottom. The bucket is wrapped with a convenient clip-on apron that features clear vinyl pockets with mesh drains that are sized to fit Harley-Davidson® cleaning and detailing products (*sold separately*). The sturdy handle and snap tight lid make transportation and storage a breeze.

**94811-10** **\$39.95**

### B. FIREMAN STYLE HOSE NOZZLE

Wash your bike in style. The unique Fireman-Style hose nozzle features a large overhand lever for convenient operation. Just adjust the lever and the nozzle maintains the pressure flow – hands free. The spray head adjusts from a steady stream to a wide fan pattern and the soft rubber nose cone protects your bike's surfaces from accidental contact. The durable metal body won't rust or corrode and the soft-touch ergonomic grip is insulated for cold-water comfort. Standard-size garden hose fitting includes gasket.

**93600016** **\$20.95**

### C. WASH MITT

This premium quality, wool-blended wash mitt features extra dense pile for scrubbing power and durability. Machine washable, this mitt attains the perfect level of absorbency and has a Bar & Shield logo sewn into the cuff. Including a thumb for added dexterity, this mitt is custom designed to be used with either hand and made specifically for washing Harley-Davidson motorcycles.

**94760-99** **\$13.95**

### D. WHEEL AND SPOKE BRUSH

The perfect partner for Wheel & Tire Cleaner, this brush features all natural fibers attached to a base coated with polypropylene to prevent scratching. With a Bar & Shield logo branded into the handle, the brush has a cone shape for efficient cleaning and durable design that won't melt on hot surfaces.

**43078-99** **\$15.95**



A. HARLEY WASH BUCKET



B. FIREMAN STYLE HOSE NOZZLE



C. WASH MITT



D. WHEEL AND SPOKE BRUSH

*Notice: The prices appearing in this catalog are the manufacturer's suggested retail prices. Actual retail prices may vary.*





**E. CLEANING BRUSH KIT**



**E. CLEANING BRUSH KIT**

Make every corner of your bike shine. This set of 3 wood-handled cleaning brushes helps you reach into the tightest places. The chamois brush gently scrubs in between engine fins or can be used after rinse to soak up hard-to-reach water. The reverse spiral brush is perfect for cleaning tire sidewalls or those hard-to-reach spaces elsewhere on your bike, and the soft mop brush will leave your chrome streak free. All brushes have vinyl-coated wires to prevent scratching.

**94844-10**

**\$29.95**

**F. BUG EATER SPONGE**

Tough on bugs but gentle on other surfaces. This easy-to-grip pad features a strong, flexible core laminated with double-sided cleaning surfaces. When paired with water and Bug Remover or Wheel & Tire Cleaner sprays, the textured orange surface helps break down and dissolve baked on bugs and road grime without scratching the surface below.

**93600110**

**\$7.95**



**F. BUG EATER SPONGE**



**G. DISPOSABLE DETAILING SOFT CLOTHS**

**G. DISPOSABLE DETAILING SOFT CLOTHS**

Rags often cause scratches in paint, but these Disposable Detailing Soft Cloths are made of special material specifically designed not to scratch paint while greatly reducing the amount of lint left behind during waxing and polishing. To avoid contamination, these disposable cloths come in a handy resealable bag. Package contains 25 towels.

**94656-98**

**\$6.95**

**H. MICROFIBER DETAILING CLOTH**

Super soft and absorbent microfiber synthetic cloth is the multi-purpose choice for washing, cleaning or buffing. The cloth can be used wet or dry and is safe for use on all surfaces and finishes. This durable 16" square cloth is mildew-resistant and machine washable. Includes convenient storage container.

**94663-02**

**\$9.95**

**I. SYNTHETIC DRYING CHAMOIS**

Made of synthetic material that is safe for use on all surface finishes. Ensures extra absorbency without streaking. Stays soft and supple even when dry. Durable, mildew-resistant and machine washable. 12" x 21" chamois stores in a convenient container.

**94791-01**

**\$9.95**



**H. MICROFIBER DETAILING CLOTH**



**I. SYNTHETIC DRYING CHAMOIS**

**J. DETAILING SWABS**

Detail those hard-to-reach places. Plush cotton swabs are perfect for removing polish and wax residue from cracks and crevices, and the strong but flexible 8" shaft allows you to clean in hard to reach areas around your engine, pipes and more. Package contains 50 swabs.

**93600107**

**\$8.95**



**J. DETAILING SWABS**



*Notice: The prices appearing in this catalog are the manufacturer's suggested retail prices. Actual retail prices may vary.*

# 830 GARAGE

## Surface Care

### A. HARLEY® BIKE WASH KIT

Bike Wash Kit includes the essentials required to clean your bike.

- *Sunwash® Bike Soap* cleaner is formulated to promote sheeting action that prevents hard water spots, and rinses clean even on hot sunny days. Biodegradable.
- *Bug Remover* spray melts away bugs without damaging metal, plastic or painted surfaces. Biodegradable.
- *Wash Mitt* features premium quality wool-blended material with extra-dense pile for scrubbing power and durability. Machine washable.
- *Bug Eater Sponge* helps remove debris without scratching surface finishes.
- *Synthetic Drying Chamois* that is safe for use on all surface finishes. Synthetic material is extra absorbent and dries without streaking.
- *Microfiber Detailing Cloth* can be used for washing, cleaning or buffing. The cloth can be used wet or dry and is safe for use on all surface and finishes.

93600056

\$49.95



A. HARLEY BIKE WASH KIT

### B. HARLEY DETAIL & PROTECT KIT

Detail & Protect Kit includes the essentials to make your bike shine.

- *Glaze™ Poly Sealant* protects against fading and the oxidizing effects of acid rain and harsh airborne pollutants. The durable, breathable, clear poly sealant with UV protection is safe for use on most painted and chrome-plated surfaces. (Not for use on matte, semi-gloss and wrinkle finish surfaces.) Biodegradable.
- *Gloss Detailer* spray delivers a high-gloss finish in the shortest amount of time. Use on paint, chrome, vinyl, plastic and windshields for added UV protection. Biodegradable.
- *Chrome Clean & Shine* non-abrasive cleaner is formulated to deliver maximum shine on chrome-plated surfaces.
- *Scratch & Swirl Repair* cream removes fine scratches and swirls from gloss paint in one step.
- *Disposable Detailing Soft Cloths* protect painted surfaces and minimize lint while waxing and polishing.
- *Microfiber Detailing Cloth* is soft and durable for detailing, cleaning or buffing. The washable cloth can be used wet or dry and is safe for use on all surfaces and finishes.
- *Detailing Swabs* feature plush tips and flexible 8" shafts for detailing hard-to-reach places.

93600057A

\$54.95



B. HARLEY DETAIL & PROTECT KIT

Notice: The prices appearing in this catalog are the manufacturer's suggested retail prices. Actual retail prices may vary.





**C. HARLEY TRAVEL CARE KIT**

**C. HARLEY® TRAVEL CARE KIT**

Everything you need to make your bike shine – except the water. Whether you are starting the ultimate biker’s garage, or want to keep your ride clean on the road, the Harley® Travel Care Kit is your answer. The kit includes five 2 oz refillable bottles of proven Harley-Davidson® cleaning products. The kit features Sunwash® Bike Soap cleaner, spray-on Bug Remover, fast-acting Wheel & Tire Cleaner, Glaze™ Poly Sealant, Gloss Detailer and a soft Microfiber Detailing Cloth. The complete kit fits easily in the compact reusable zip-closure bag so you can take it along for the ride or store it neatly in your garage.

**9360007** Five 2 oz Bottles. **\$25.95**

**D. HOG® BLASTER MOTORCYCLE DRYER**

Dry your bike in minutes with the HOG® Blaster. This powerful dryer blows a stream of warm, dry, filtered air at 18,000 feet/minute, allowing you to cut your drying time up to 75%. The HOG Blaster reduces streaks and water spots because water can't hide in hard to reach places. No more annoying drips and runs when you move your bike. With an ergonomically friendly design for comfortable handling, the HOG Blaster features a durable all-steel outer shell, a 1.3 hp motor and a grounded electrical cord. Kit includes blower unit, flexible hose and 2 diffuser attachments. One-year manufacturer’s warranty on blower unit.

**94651-09** 120V, Grounded 3-prong Plug. **\$124.95**  
United States, Canada and Mexico.

**94865-09** 220V, 2-pin Plug. **\$129.95**  
Europe.

**E. SADDLEBAG STORAGE STAND**

Never set your saddlebags on the ground again. This convenient folding rack holds Touring hard saddlebags while you wash or work on your bike and utilizes the bag’s quarter-turn quick-disconnect fasteners to securely lock them in place. The strong, lightweight rack features 4 adjustable feet to level the stand and keep the bags off the ground. You can wash, dry, detail and re-install the bags with minimal handling. Stand accommodates both standard and extended hard saddlebags.

**94778-10** **\$99.95**

For use with Touring model standard and extended-length saddlebags.



**D. HOG BLASTER MOTORCYCLE DRYER**



**E. SADDLEBAG STORAGE STAND**

*Notice: The prices appearing in this catalog are the manufacturer’s suggested retail prices. Actual retail prices may vary.*

# HARLEY-DAVIDSON® MOTORCYCLE COVERS

Welcome to the best-dressed list. Unlike a tarp and bungee cords, Harley-Davidson® Motorcycle Covers fight the effects of the elements and protect your bike's paint and finishes from the rough world around us. Whether your bike spends its time in a heated garage or on the driveway, we've got you covered.

## ANTENNA ACCESS

Touring and Trike covers feature hook-and-loop opening at the rear to accommodate antennas.

## WATER-RESISTANT SEAMS

Heavy-duty Indoor/Outdoor covers feature taped overlapping seams for water resistance.

## MOISTURE REDUCTION

Weather-shielded vents or breathable materials promote air circulation and minimize corrosion during short or long term storage.

## HEAT-RESISTANT PANELS

Indoor/Outdoor and Premium Indoor Covers feature heat-resistant panels that protect the cover from warm exhaust.

## REFLECTIVE TRIM

High-visibility reflective trim makes a parked and covered bike more obvious.

## BELLY STRAPS

Quick-release adjustable straps cinch the cover under the frame to reduce ballooning in the wind.

## INTEGRATED STORAGE POUCH

After use, just fold the cover into the convenient integrated storage pouch.



## CORSET-STYLE BACKBONE

Simple-to-use cinching system customizes the cover for best fit. Just pull the cord and cover adjusts to the bike's contours.



## ADJUSTABLE HEM

Drawstring hem allows custom-tailored fit around the bike and eliminates the one-size-fits-some elastic cord.



## LOCK ACCESS

Sewn-in grommets near the front wheel simplify the use of a cable lock or security chain (cable/lock not included).



## COVER ALARM POCKET

Hidden pocket accepts optional battery-powered alarm. If the cover is disturbed, the 130-dB alarm is triggered.





**A. INDOOR/OUTDOOR MOTORCYCLE COVER – ORANGE/BLACK WITH HARLEY-DAVIDSON GRAPHICS**

### A. INDOOR/OUTDOOR MOTORCYCLE COVER\*

Guard your bike from Mother Nature. Perfect for a bike that is exposed to the elements, this heavy duty cover is manufactured from diamond-pattern 300 Denier fade-resistant polyester and features taped seams for water resistance. The weather-shielded vents in the top of the cover promote air circulation to reduce moisture build-up and minimize corrosion during short or long term storage. Internal heat-resistant panels protect the cover from warm exhaust and an integrated storage pouch permits convenient packing when not in use. The cover skirt features front and rear adjustable drawstrings to cinch the cover around the bike and a convenient belly strap to reduce ballooning in the wind. The corset-style cinching system along the backbone lets you adjust the cover for best fit on a variety of models and the hook-and-loop opening on Touring and Trike covers accommodate antennas. Cover features a convenient opening near the front wheel for a security chain or cable and internal pockets that accept the optional Cover Alarm (P/N 69000038). Available in your choice of two-tone orange and black or inconspicuous plain black finish, the covers features reflective piping for added visibility.

Fits VRSC™, XG, XL, XR, Dyna® and Softail® models.

<b>93100022</b>	H-D® Orange/Black.	<b>\$149.95</b>
<b>93100025</b>	Black.	<b>\$139.95</b>

Fits Touring and Freewheeler™ models. Does not fit FLHXXX or FLHTCUTG models.

<b>93100023</b>	H-D Orange/Black.	<b>\$159.95</b>
<b>93100026</b>	Black.	<b>\$149.95</b>

Fits Trike models.

<b>93100024</b>	H-D Orange/Black.	<b>\$189.95</b>
<b>93100027</b>	Black.	<b>\$179.95</b>



**A. INDOOR/OUTDOOR MOTORCYCLE COVER – BLACK**



**A. INDOOR/OUTDOOR TRIKE COVER – ORANGE/BLACK**



**A. INDOOR/OUTDOOR TRIKE COVER – BLACK**

\*NOTE: H-D® motorcycle covers are not designed to be used while trailering. Using an H-D motorcycle cover while trailering may cause the cover to tear, possibly causing damage to the cover and motorcycle.

Notice: The prices appearing in this catalog are the manufacturer's suggested retail prices. Actual retail prices may vary.

# 834 GARAGE

## Motorcycle Covers

### A. PREMIUM INDOOR MOTORCYCLE COVER\*

Pamper your bike. This luxuriously soft microfiber cover is ideal for short and long term indoor storage. The breathable microfiber material promotes air circulation to reduce moisture build-up and minimize corrosion. Cover skirt features front and rear adjustable drawstrings to cinch the cover around the bike and a convenient belly strap to reduce ballooning in the wind. The corset-style cinching system along the backbone lets you adjust the cover for best fit on a variety of models. The covers feature heat-resistant panels that protect the material from warm exhaust and the hook-and-loop opening at the rear of Touring and Trike covers accommodates antennas. Cover features a convenient opening near the front wheel for a security chain or cable and internal pockets that accept the optional Cover Alarm (P/N 69000038). The two-tone orange and black cover features reflective piping for added visibility and an integrated storage pouch for convenient packing when not in use.

**93100019** H-D® Orange/Black. **\$149.95**  
Fits VRSC™, XG, XL, XR, Dyna® and Softail® models.

**93100020** H-D Orange/Black. **\$159.95**  
Fits Touring and Freewheeler™ models. Does not fit FLHXXX or FLHTCUTG models.

**93100021** H-D Orange/Black. **\$189.95**  
Fits Trike models.



A. PREMIUM INDOOR MOTORCYCLE COVER

### B. INDOOR MOTORCYCLE COVER\*

Protect your bike from dust and scratches. Perfect for a bike that's parked indoors, this breathable polyester cover promotes air circulation to reduce moisture build-up and minimize corrosion during short or long term storage. Cover skirt features front and rear adjustable drawstrings to cinch the cover around the bike and a convenient belly strap to reduce ballooning in the wind. The corset-style cinching system along the backbone lets you adjust the cover for best fit on a variety of models and the hook-and-loop opening at the rear accommodates antennas. Cover features a convenient opening near the front wheel for a security chain or cable and internal pockets that accept the optional Cover Alarm (P/N 69000038). The two-tone orange and black cover features reflective piping for added visibility and an integrated storage pouch for convenient packing when not in use.

**93100018** H-D Orange/Black. **\$99.95**  
Fits VRSC, XG, XL, XR, Dyna, Softail, Touring and Freewheeler™ models. Does not fit FLHXXX or FLHTCUTG models.



A. PREMIUM INDOOR MOTORCYCLE COVER — TRIKE



B. INDOOR MOTORCYCLE COVER

\*NOTE: H-D® motorcycle covers are not designed to be used while trailering. Using an H-D motorcycle cover while trailering may cause the cover to tear, possibly causing damage to the cover and motorcycle.

Notice: The prices appearing in this catalog are the manufacturer's suggested retail prices. Actual retail prices may vary.





**C. OASIS DAY COVER**

**C. OASIS DAY COVER\***

Keep your seat dry when you stop for the night. Lightweight and compact for travel, this easy-to-store cover rolls into the built-in bag. Made from soft micro-fiber, the black and orange water repellent fabric dries quickly for a quick get away. Hook-and-loop closures in the rear let you slip the cover over your antennas and the elastic bottom hem and footboard stirrups ensure a snug fit. The "Harley-Davidson" script and Bar & Shield logo prominently stand out on the fabric.

**93100028** H-D® Orange/Black. **\$109.95**  
Fits Touring and Trike models equipped with Tour-Pak® luggage.

**D. MOTORCYCLE COVER ALARM**

Protect your covered motorcycle from tampering. Self-contained alarm fits into the pocket on select H-D® Motorcycle Covers. The snap swivel clips to spokes, rotors or other fixed parts and the cord leads back to the alarm pin. If the cover is pulled off the bike, the pin is pulled, triggering the 130-dB alarm. Weatherproof alarm is powered by a replaceable 9V battery (not included).

**69000038** **\$29.95**  
Fits select H-D Motorcycle Covers with alarm pocket.

**E. SIDECAR COVER WITH EAGLE LOGO\***

Constructed from tough, lightweight, 250 denier water-repellent polyester. Matches Harley-Davidson® touring-style motorcycle cover, but is specifically sized to cover the body and windshield of your sidecar. Includes protective windshield liner, silkscreened Eagle logo and elastic edging for a secure fit.

**98725-91** Fits all H-D sidecars. **\$99.95**

**WARNING:** Do not use with someone riding inside. Doing so could result in death or serious injury.

**F. HARLEY® BUBBLE**

The Harley® Bubble is designed to constantly flow filtered air over the bike, providing a dust-free, condensation-free environment that greatly decreases the chances of corrosion during storage. The bike stays clean, dry, and best of all, can be viewed even while it's being stored. For indoor and North American use only. 110-volt only.

**94646-98** **\$299.95**  
Fits models with Windshields and Tour-Pak luggage (except '14-later Touring models with Tour-Pak luggage). Does not fit Trike or models equipped with a sidecar.

**94662-98** **\$299.95**  
Fits Sport and Cruising models.

**Also available:**

**Replacement Air Intake Filter for Harley Bubble**  
**94688-00** **\$9.95**  
Fits both Touring and Sport Harley Bubbles.



**D. MOTORCYCLE COVER ALARM**



**E. SIDECAR COVER WITH EAGLE LOGO**



**F. HARLEY BUBBLE**

\*NOTE: H-D® motorcycle covers are not designed to be used while trailering. Using an H-D motorcycle cover while trailering may cause the cover to tear, possibly causing damage to the cover and motorcycle.

Notice: The prices appearing in this catalog are the manufacturer's suggested retail prices. Actual retail prices may vary.

# 836 GARAGE

## Motorcycle Covers

### A. SERVICE COVERS\*

Protect the finish on your tank and fenders while performing routine service on your motorcycle. These custom shaped covers feature an easy-to-clean black vinyl outer surface and a soft non-abrasive fleece inner liner. Fuel tank covers feature built-in magnets to prevent the cover from sliding, convenient mesh pockets to keep small parts from rolling away and a clear paperwork window for notes and instruction sheets. Fender covers feature soft elastic bands to keep the covers firmly in place. To complete the look, the cover features a nostalgic Harley-Davidson® logo that will look great in any garage.

<b>94640-08</b>	Large Fuel Tank. Fits Dyna®, Softail®, Touring and Trike models.	<b>\$31.95</b>
<b>94642-08</b>	Sportster® 3.5 Gallon Fuel Tank. Fits XL models with 2.2 or 3.3 gallon fuel tank.	<b>\$30.95</b>
<b>94645-08</b>	Sportster 4.5 Gallon Fuel Tank. Fits XL models with 4.5 gallon fuel tank. Also fits XG models.	<b>\$31.95</b>
<b>94641-08</b>	Large Front Fender. Fits FLD, FL Softail (except FLS), Touring and Trike models.	<b>\$31.95</b>
<b>94643-08</b>	Small Front Fender. Fits XG, XL, XR, Dyna and FX Softail models.	<b>\$29.95</b>



**A. SERVICE COVER –  
(LARGE FUEL TANK SHOWN)**

**A. SERVICE COVER –  
(LARGE FENDER SHOWN)**

### B. COTTON WINDSHIELD STORAGE BAG

This bag is constructed of breathable cotton material and is designed for a scratch-free storage area. The outside of the bag features an embroidered Bar & Shield logo to match the cotton cycle covers.

<b>95982-98B</b>	Fits all Harley-Davidson® windshields.	<b>\$69.95</b>
------------------	--	----------------

### C. SOFT STORAGE BAG FOR FAIRING LOWERS

Protect your fairing lowers when they are removed for hot weather riding. This convenient storage bag features a heavy-weight 10 oz cotton exterior and sturdy carrying handle. Dual zippers open to expose a soft felt interior with a sturdy divider for left and right lowers and two zippered pouches for loose hardware storage. A classic embroidered Bar & Shield logo adorns the bag's exterior.

<b>95983-07</b>	Fits all styles of Harley-Davidson Fairing Lower (except Twin-Cooled™ models).	<b>\$79.95</b>
-----------------	--	----------------



**B. COTTON WINDSHIELD STORAGE BAG**

**C. SOFT STORAGE BAG FOR FAIRING LOWERS**

### D. RAIN COVERS\*

Featuring a handy storage sack, this black nylon, water-resistant, Cordura® cover packs easily and shelters your seat from the storm.

<b>51638-97</b>	Solo Seat. Fits H-D® solo seats (except XR and FLSTS).	<b>\$29.95</b>
<b>51639-97</b>	Touring Seat. Fits FLSTC, FLSTS and most Touring and Trike seats. Does not fit with rider or passenger backrests.	<b>\$31.95</b>
<b>51637-97</b>	Two-Up Seat. Fits H-D two-up seats (except XR, FLSTC, FLSTS or seats with rider backrests).	<b>\$31.95</b>
<b>52952-97</b>	Seat with Rider Backrest. Fits most seats with rider backrest. Does not fit Trike models.	<b>\$39.95</b>



**D. RAIN COVER – TOURING SEAT**

**E. JIFFY STAND COASTER**

### E. JIFFY STAND COASTER

Designed for use beneath the jiffy stand, this polypropylene coaster prevents the stand from sinking into soft surfaces such as dirt, asphalt and grass.

<b>94647-98</b>	Fits motorcycles equipped with a sidestand.	<b>\$5.95</b>
-----------------	---	---------------

\*NOTE: H-D® motorcycle covers are not designed to be used while trailering. Using an H-D motorcycle cover while trailering may cause the cover to tear, possibly causing damage to the cover and motorcycle.

Notice: The prices appearing in this catalog are the manufacturer's suggested retail prices. Actual retail prices may vary.



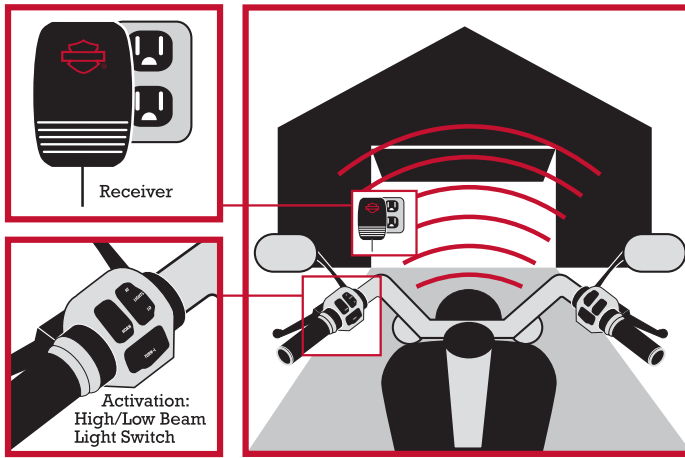

### F. REMOTE CONTROL GARAGE DOOR OPENER KIT

Operate your automatic garage door opener without leaving your motorcycle seat or fumbling in your pocket for the remote control. Compatible with most brands of automatic openers, this kit allows you to operate your door by cycling the bike's high-beam switch. The hidden transmitter splices into your bike's wiring harness and is powered by your vehicle battery, so there are no transmitter batteries to replace. When your key is switched off the transmitter is disabled, providing added garage security if you park your bike outside. The signal is sent to the in-garage receiver that plugs into a standard 110-volt outlet and is wired to the automatic opener. The receiver's rolling code technology provides additional security. Kit includes one transmitter and one receiver. Individual components are available to equip additional motorcycles and garages.

**91558-01B Complete Kit. \$139.95**

Fits '02-later VRSC™, '15-later XG, '94-later XL, '08-'13 XR, '96-later Dyna® and '96-later Softail® models. Also Fits '94-later Touring and Trike models. '14-later XL, '12-later Dyna and '11-later Softail models require separate purchase of Electrical Connection Kit P/N 72673-11. '14-later Touring and Trike models require separate purchase of Electrical Connection Kit P/N 69200722. '15-later XG models require separate purchase of P/N 72136-94GY, 72156-94 and 4x 72195-94.

#### 1. Remote Control Garage Door Opener Transmitter

This kit allows owners of the Remote Garage Door Opener P/N 91558-01B to equip each of their Harley-Davidson® motorcycles with a remote transmitter.

**91561-01B \$74.95**

For use with Remote Control Garage Door Opener Kit P/N 91558-01B. '14-later XL, '12-later Dyna and '11-later Softail models require separate purchase of Electrical Connection Kit P/N 72673-11. '14-later Touring and Trike models require separate purchase of Electrical Connection Kit P/N 69200722. '15-later XG models require separate purchase of P/N 72136-94GY, 72156-94 and 4x 72195-94.

#### 2. Remote Control Garage Door Opener Receiver

This additional receiver permits the owner of the Remote Garage Door Opener P/N 91558-01B to operate more than one garage door opener from a single transmitter.

**91562-01 \$74.95**

For use with Remote Control Garage Door Opener Kit P/N 91558-01B.

#### 3. Remote Control Garage Door Opener Key Fob

Operate your Harley-Davidson Remote Garage Door Opener from your car. This Key Fob fits on your key ring and works with the rolling code technology of the receiver to provide added security. Because up to eight devices can be programmed for use with a single Remote Garage Door Opener Receiver, everyone in your family can have access. Two buttons can be set for use on multiple Remote Garage Door Openers. Indicator light shows Fob is working. Batteries included.

**91569-01 \$49.95**

For use with Remote Control Garage Door Opener Kit P/N 91558-01B.

### G. HELMET HANGER

Proudly display your collection of helmets. Harley-Davidson Helmet Hangers keep your expensive helmet safe and out of the way. Designed to accommodate all types of helmets, these Helmet Hangers allow air to circulate inside to keep the liner fresh and dry. The rigid steel hooks feature a durable e-coated surface and soft rubber edges to protect the finish of the helmet. The wall-mount J-Hook design can be secured to a trailer wall, garage wall or most any flat surface. The universal S-Hook design hangs on doors, cubical walls and closet rods.

**93100034 J-Hook. \$24.95**

**93100035 S-Hook. \$24.95**

*Notice: The prices appearing in this catalog are the manufacturer's suggested retail prices. Actual retail prices may vary.*

F. REMOTE CONTROL GARAGE DOOR OPENER KIT



G. HELMET HANGER – J-HOOK



G. HELMET HANGER – S-HOOK



# VERSATILE STORAGE

The Detach Depot Garage Storage System provides versatile, secure, off-the-floor storage for removable accessories — saving valuable shelf and floor space. The convenient Detach Depot Wall Rack and Saddlebag Mounts put H-D® Detachables™ within easy reach and protect your components from storage wear and tear.



FOR A 360° VIEW

▶ For a video view, log on to: [www.h-d.com/partsvideos](http://www.h-d.com/partsvideos)

## DETACH DEPOT EXAMPLE CONFIGURATIONS



### WALL RACK

The Detach Depot Wall Rack can be adjusted to accommodate a wide variety of detachable accessories. Just mount the rack to the wall studs, move the soft-touch rods into position and mount your accessories. The versatile storage rack has the flexibility to grow with you as you change bikes or add more accessories.



SPORTSTER®  
H-D DETACHABLES™



DYNA®  
H-D DETACHABLES



SOFTAIL®  
H-D DETACHABLES



SOFTAIL® DELUXE  
H-D DETACHABLES



ROAD KING® CLASSIC  
H-D DETACHABLES



TOURING  
H-D DETACHABLES



### SADDLEBAG MOUNTS

The Detach Depot Saddlebag Mounts securely position your Sportster®, Dyna® or Softail® detachable saddlebags off the floor and out of the way. Just bolt the brackets to the wall studs, adjust the docking points, and utilize the saddlebag's built-in hardware to lock the bags in place.



SPORTSTER  
H-D DETACHABLES SADDLEBAGS



DYNA  
H-D DETACHABLES SADDLEBAGS



FAT BOY®  
H-D DETACHABLES SADDLEBAGS





# GARAGE 839

H-D® Detachables™ Storage



**A. DETACH DEPOT WALL RACK**

## A. DETACH DEPOT WALL RACK

Declutter your garage! Detachable windshields, backrests, luggage racks and Tour-Pak® luggage increase the versatility of your bike and allow you to equip your motorcycle for today's ride. Add the accessories to the bike when you need them, and pop them off when you don't. But what do you do with the H-D® Detachables™ when they are not on the bike? The Detach Depot Wall Rack offers an off-the-floor, secure storage place for your detachable accessories. You no longer need to find acres of shelf space or worry about tripping over your detachable components. This heavy-duty Detach Depot Wall Rack can be mounted to any wall, and the 16" on-center design lets you mount it securely to the studs. The rack features 5 coated rods that can be positioned in a wide variety of adjustable mounting slots. Just install the rods in the appropriate location, tighten them down and click your detachable accessories in place. Adjustable rods can accommodate almost any combination of accessories. Kit includes black-finished side panels, 5 coated rods, decorative end caps and all necessary mounting hardware.

**93100005** **\$199.95**

For use with Harley-Davidson® Detachables products including Tour-Pak mounting racks, Sissy Bars, Luggage Racks, Rider Backrests and H-D Detachables-style Windshields. Quick-Release style Windshields and Rider Backrests require separate purchase of auxiliary mount kits.

## B. DETACH DEPOT QUICK-RELEASE WINDSHIELD MOUNTS

Required for installation of Quick-Release Windshields on Detach Depot Wall Rack. Stepped conical mounts slip onto the Detach Depot Wall Rack's adjustable rods and allow the clamp-style quick-release windshield mounts to firmly lock in place. Kit includes 2 stepped mounts.

**93100015** **\$24.95**

For use with Harley-Davidson Quick-Release Windshields (except XG windshields) and Detach Depot Wall Rack P/N 93100005.

## C. DETACH DEPOT RIDER BACKREST MOUNT

Store your Touring Rider Backrest safely in your garage when it's not on your bike. This compact bracket mounts to the Detach Depot Wall Rack side plate and allows you to hang the rider backrest pad in a convenient location. Kit includes mounting bracket and required hardware.

**93100016** **\$24.95**

For use with Harley-Davidson Touring model Rider Backrest and Adjustable Rider Backrest Kits and Detach Depot Wall Rack P/N 93100005.

## D. DETACH DEPOT FOR SADDLEBAGS

H-D Detachables saddlebags offer a versatile option to outfit your Sportster®, Dyna® or Softail® model as a cross-country tourer. But what do you do with the bags when you want to dress your bike down for a night on the town? The Detach Depot for Saddlebags offers a secure, off-the-floor storage solution. Don't worry about tripping over or damaging your H-D Detachables Saddlebags when they are not on your bike. These heavy-duty brackets can be easily attached to any wall in your garage and feature adjustable docking points that function just like the mounting points on your motorcycle. Just position the saddlebag on the mount and lock the bag in place. Designed with 16" on-center mounting holes, the brackets can be attached directly to the wall studs and can be positioned for convenient storage height. Kit includes brackets, docking points and mounting hardware.

**93100002** **\$99.95**

For use with Sportster®, Dyna® (except FLD) and Softail® Harley-Davidson Detachables Saddlebags.

**93100032** **\$99.95**

For use with Dyna FLD detachable saddlebags.



**B. DETACH DEPOT QUICK-RELEASE WINDSHIELD MOUNTS**



**C. DETACH DEPOT RIDER BACKREST MOUNT**



**D. DETACH DEPOT FOR SADDLEBAGS**

Notice: The prices appearing in this catalog are the manufacturer's suggested retail prices. Actual retail prices may vary.

# 840 GARAGE

Lifts & Cradles

## A. MOTORCYCLE SERVICE LIFT

This low profile hydraulic lift fits under any Harley-Davidson® motorcycle. The 1,100 capacity lift can raise a 2-wheel Harley model 16.9" from the floor. The lift features 2 fixed and 2 swivel heavy duty wheels and a removable T-handle for easy maneuverability. The durable high-visibility Harley orange powder coat finish is easy to clean. Kit includes lift and 2 tie-down straps. This product is not available for sale in the following markets – Europe, Middle East and Africa.

**92900004** **\$299.95**

Fits all Harley-Davidson V-Twin models (except Trike and models equipped with a Sidecar). Softail® models require Frame Protector Kit P/N 94675-99, Twin Cam-equipped Dyna® models require Adapter Kit P/N 98965-99, both sold separately.

### Also available:

#### FRAME PROTECTORS *(not shown)*

Use these Frame Protectors to protect the underside of your motorcycle when using any lift. A must for Softail models to provide the clearance necessary to keep lift pressure on the frame and not the shock absorbers. Universal and customizable to fit any V-Twin Harley-Davidson motorcycle. Sold in pairs.

**94675-99** Fits all 1.25" frame tubes. **\$25.95**

#### MOTORCYCLE SERVICE LIFT ADAPTOR KIT FOR DYNA® TWIN CAM MODELS *(not shown)*

Provides the necessary clearance of the oil tank that allows the Motorcycle Service Lift P/N 92900004 to be used on '99-later Dyna models equipped with a Twin Cam engine.

**98965-99** **\$25.95**



A. MOTORCYCLE SERVICE LIFT



A. MOTORCYCLE SERVICE LIFT

Notice: The prices appearing in this catalog are the manufacturer's suggested retail prices. Actual retail prices may vary.





▶ For a video view, log on to:  
[www.h-d.com/partsvideos](http://www.h-d.com/partsvideos)

**B. CRUISER CRADLE WHEEL CHOCK (SHOWN WITH TRAILER ADAPTER KIT)**

### B. CRUISER CRADLE WHEEL CHOCK

This sturdy aluminum wheel chock will hold your bike securely on the ground, on a trailer or in the back of a pickup truck. Sized to fit most motorcycles, this wheel chock will keep your bike upright while you are storing, transporting or working on your bike. Designed for roll-on roll-off use, the rocking cradle allows one person to easily park their bike in the stand. Just roll the bike into place and dismount. The Cruiser Cradle holds the bike in place without straps. Upright storage saves garage space and permits easy access to both sides of the vehicle.

Cruiser Cradle's utility is not limited to the garage. The light-weight, folding wheel chock is easy to transport. Use it on the driveway when you are washing your bike or, when equipped with the optional Trailer Adapter, the versatile wheel chock can be easily moved to a trailer or the back of a pickup truck. The one-person operation simplifies securing the bike for transport. Load the bike into the Cruiser Cradle, dismount and the bike remains upright. Just two tie-down straps are required to hold the bike in place. And because you don't need to over-tighten the straps, you won't damage sensitive suspension parts and handlebar bushings.

**92900001 \$259.95**  
For use with models with vehicle weight up to 3000 lb (1360 kg) and front or rear wheel size of 14" to 22" (355-560mm) rim diameter and 3.15" to 8.66" (80mm-220mm) nominal wheel width.

Also available:

### CRUISER CRADLE TRAILER ADAPTER KIT

Cruiser Cradle Trailer Adapter Kit is engineered to simplify installation of Cruiser Cradle Wheel Chock on many trailers – from enclosed trailers to flat-bed style open versions. Simply mount the low profile kit to the floor of your trailer and the Cruiser Cradle can be attached in seconds, without tools.

**92900002 \$34.95**  
For use with Cruiser Cradle Wheel Chock P/N 92900001 on trailer applications.

### C. CRUISER CRADLE WHEEL CHOCK – TRAILER ONLY VERSION

Sized to fit most motorcycles, this wheel chock will keep your bike upright while you are transporting or working on your bike. Designed for roll-on roll-off use, the rocking cradle allows one person to easily park their bike in the stand. Just roll the bike into place and dismount. Just two tie-down straps are required to hold the bike in place. And because you don't need to over-tighten the straps, you won't damage sensitive suspension parts and handlebar bushings. The Trailer-Only chock can be removed from the trailer in seconds with four wing nuts or the optional E-Track Adapter and can be folded down when not in use. Includes all brackets and hardware to mount a trailer or lift table.

**92900042 \$199.95**  
For use with models with vehicle weight up to 3000 lbs (1360 kg) and front or rear wheel size of 14" to 22" (355-560mm) rim diameter and 3.15" to 8.66" (80mm-220mm) nominal wheel width.

### D. CRUISER CRADLE UNIVERSAL E-TRACK ADAPTER KIT

This heavy-duty plated steel kit secures the Cruiser Cradle Wheel Chock to standard E-Track on any trailer platform, whether the E-Track is above the floor, recessed or flush-mounted. You can adjust the position of the chock anywhere along the E-Track for maximum flexibility in positioning a motorcycle and the chock can be adjusted side-to-side between 27" and 43" wide. The Universal E-Track Adapter Kit includes all the necessary hardware and including a Boomerang Bar for added Wheel Chock stability. Ratchet tie-downs are required for transporting the motorcycle.

**92900043 \$119.95**  
For use with Cruiser Cradle Wheel Chock P/N 92900001 or 92900042 on trailer applications.

### E. E-TRACK TIE-DOWN RING

This steel Tie-Down Ring is used to strap motorcycles to a trailer equipped with the E-Track docking system. The Tie-Down ring is quickly secured and easily repositioned by pressing the release lever. The 3/8" thick ring has a 2" inner diameter and has 5,000 lb. load capacity. Zinc plated for corrosion protection. Sold individually.

**92900045 \$7.95**



NEW

**C. CRUISER CRADLE WHEEL CHOCK – TRAILER ONLY VERSION**



NEW

**D. CRUISER CRADLE UNIVERSAL E-TRACK ADAPTER KIT**



NEW

**D. CRUISER CRADLE UNIVERSAL E-TRACK ADAPTER KIT (SHOWN WITH WHEEL CHOCK)**



NEW

**E. E-TRACK TIE-DOWN RING**

Notice: The prices appearing in this catalog are the manufacturer's suggested retail prices. Actual retail prices may vary.

# 842 GARAGE

## Motorcycle Tie-Downs

### A. HARLEY-DAVIDSON® HOG TIES® 1.5" CAM BUCKLE TIE-DOWN STRAPS

600 lbs Working Load – 1.5" x 66"

Made and designed specifically for Harley-Davidson® motorcycles, these are among the sturdiest cam buckle tie-downs on the market. Each tie-down is a full 1-1/2 inch wide, 6,000 lbs abrasion resistant Nylon webbing with vinyl coated steel "S" hooks and a sturdy buckle that features the Harley-Davidson Bar & Shield logo and an added pressure plate to provide superior grip on the webbing. The assembly is pre-threaded through the cam and ready to use out of the package. It also has a sewn hand loop on the adjustable end to prevent the webbing from pulling loose from the cam. Sold in pairs.

**94649-98** Fits all models. **\$44.95**

Shown with:

### HOG TIES® 1.5" CAM BUCKLE TIE-DOWN STRAPS WITH INTEGRATED SOFT HOOKS

600 lbs Working Load – 1.5" x 66"

This version of the popular Hog Ties® tie-down has all the features of the standard Hog Ties tie-down straps plus an added Soft Hook built into the assembly allowing your choice of either the soft or steel hook against the motorcycle. It is especially useful for avoiding pinching of brake lines, wiring or other parts that can be damaged by steel hooks. Sold in pairs.

**94672-99** Fits all models. **\$49.95**



A. HOG TIES TIE DOWN STRAPS

### B. HARLEY-DAVIDSON 1.5" GRADUAL RELEASE RATCHET TIE-DOWN STRAPS

600 lbs Working Load – 1.5" x 66"

These heavy duty ratchet straps provide maximum tensioning power and a higher working load capacity with the added benefit of being able to release the tension one click at a time. The ratchet is built with a comfortable molded grip handle and a dual-direction reversing drive that permits the spindle to rotate backwards releasing tension until it reaches 60 lbs. This option helps eliminate the "snap back" release common with most standard ratchet designs under heavy load and also permits the even tensioning of straps without having to release all of the webbing and start over. The strap also features heavy duty 6,000 lbs abrasion resistant Nylon webbing, a built in Soft Hook with vinyl coated full size "S" hook on the fixed end and an large closed end carabiner hook on the adjustable end to keep it hooked securely during the tie-down process. Sold in pairs.

**94706-10** **\$64.95**

Ratchet Straps with Integrated Soft Hook.



B. 1-1/2" GRADUAL RELEASE RATCHET TIE-DOWN STRAPS

### C. HARLEY-DAVIDSON 1.25" RATCHET TIE-DOWN STRAPS

400 lbs Working Load – 1.25" x 78"

These 1-1/4" Harley-Davidson Tie-Downs have a 1,200 lb capacity and feature Harley-Davidson scripted webbing with a loop handle for easy pulling. Vinyl-coated hooks feature spring loaded one-way wire loop gates that hold the hook in position, simplifying initial tie-down setup. Harley-Davidson Ratchet Tie-Down Straps feature lever-action ratchets for use when greater tensioning power is needed. Straps are also available with integrated soft hooks that are designed to keep the coated hard hooks away from delicate surfaces. Sold in pairs.

**1. 94699-10** Ratchet Straps. **\$44.95**

**2. 94704-10** **\$49.95**

Ratchet Straps with Integrated Soft Hook.



C. HARLEY-DAVIDSON 1-1/4" RATCHET TIE-DOWN STRAPS

Notice: The prices appearing in this catalog are the manufacturer's suggested retail prices. Actual retail prices may vary.





**D. ANCRA RAT-PACK RATCHET STYLE TIE-DOWN STRAPS**



**E. ANCRA ORIGINALS CAM BUCKLE TIE-DOWN STRAPS**



**F. FLEECE SOFT HOOKS**



**G. HARLEY-DAVIDSON 18" SOFT HOOKS**



**H. HOG TIES SOFT HOOKS**



**I. ANCRA SOFT HOOK EXTENSIONS**

**D. ANCRA® RAT-PACK RATCHET STYLE TIE-DOWN STRAPS**

400 lbs Working Load – 1" x 66"

The original ratchet tie-down for motorcycles locks secure and provides the added tension needed to secure bikes and ATVs for longer hauls. Straps feature a wider grip ratchet handle, 4,500 lbs abrasion resistant Nylon webbing, full size vinyl coated "S" hooks on fixed ends and non-coated steel "S" hooks on the adjustable ends. Sold in pairs.

**98187-90T \$37.95**

**E. ANCRA ORIGINALS™ CAM BUCKLE TIE-DOWN STRAPS**

400 lbs Working Load – 1" x 66"

The original cam buckle strap for motorcycles allows quick and easy securing of the vehicle for transport. Straps feature 4,500 lbs abrasion resistant Nylon webbing, full size vinyl coated "S" hooks on both ends and an added pressure plate in the buckle to provide superior grip on the webbing. Sold in pairs.

**98186-84T Black \$34.95**

**F. HARLEY-DAVIDSON® FLEECE SOFT HOOKS**

400 lbs Working Load – 1.25" x 18"

These 18" Soft Hooks are designed to keep ratchets, hooks and buckles away from delicate surfaces. The soft synthetic sheepskin cover cushions the surface and protects handlebars, triple trees and other tie-down points from scratches and abrasion. Each soft hook has a capacity of 2,400 lb. Sold in pairs.

**93100017 Fits all models. \$15.95**

**G. HARLEY-DAVIDSON SOFT HOOKS**

400 lbs Working Load – 1.25" x 18"

These Harley-Davidson® 18" Soft Hooks keep ratchets and buckles away from delicate surfaces. Each soft hook has a capacity of 2,400 lb. Sold in pairs.

**94705-10 Fits all models. \$11.95**

**H. HOG TIES® SOFT HOOKS**

600 lbs Working Load – 1.5" x 18"

Wider and stronger, Hog Ties® Soft Hooks are designed to be used in conjunction with standard Hog Ties Straps to keep hooks from direct contact with handlebars, fairings, brake lines, wiring and painted surfaces. Secure to bike then secure tie-down hook to opposite end. Made with 6,000 lbs Nylon webbing. Sold in pairs.

**94650-98 Fits all models. \$10.95**

**I. ANCRA SOFT HOOK EXTENSIONS**

400 lbs Working Load – 1" x 12" or 1" x 18"

Made with 4,500 lbs Nylon webbing, Ankra soft hook extensions provide an effective way to keep hooks from direct contact with handlebars, fairings, brake lines, wiring and painted surfaces. Secure to bike then secure tie-down hook to opposite end. Sold in pairs.

**98192-85T 12 inches. \$8.95**

**98193-85T 18 inches. \$9.95**

Notice: The prices appearing in this catalog are the manufacturer's suggested retail prices. Actual retail prices may vary.

# 844 GARAGE

## Motorcycle Locks

### A. DISC BRAKE LOCK AND REMINDER CORD<sup>1\*</sup>

Designed to prevent roll-away theft, this lock provides security protection and resists cutting and chisel attacks. Hardened drop-forged steel lock features a dual-reinforced high-security disc-style cylinder and blade-style key. The sleek and compact design is available in mirror-chrome or in a bright orange finish for maximum visibility. Kit includes 2 blade-style keys and a high-visibility reminder cord that loops from the lock to the handlebar as a visual indication that your lock is still engaged. Key registration and replacement service is available.

Fits front brake rotor on '83-later models, except those with 19-inch laced front wheels. On VRSC™ models, fits on rear brake rotor, does not fit front brake rotor on models equipped with solid disc wheels.

<b>46086-98A</b>	Chrome.	<b>\$49.95</b>
<b>94873-10</b>	Orange.	<b>\$49.95</b>

#### Also available:

#### LOCK REMINDER CORD<sup>1</sup>

Remember to remove your Disc or Fork Lock before beginning your ride with this high-visibility Reminder Cord. Flexible, coiled, bright orange cord loops from external lock to handlebar, acting as a visual indication that your lock is still engaged.

<b>46318-04</b>	Universal.	<b>\$4.95</b>
-----------------	------------	---------------



A. DISC BRAKE LOCK AND REMINDER CORD – ORANGE

### B. H-D® 12MM ACCESSORY CABLE LOCK<sup>1,2\*</sup>

This 12mm multi-purpose cable lock is ideal for securing helmets, leathers and other items. The braided steel cable features a protective vinyl cover and a soft molded lock cover to prevent scratches. The integrated lock features a snap-shut keyway for weather protection, and the flexible cable can be coiled tightly for convenient storage. Orange highlights improve visibility for added theft deterrence. Kit includes 2 blade-style keys. "Key Safe" registration and replacement service is available. Cable length: 6.0'.

<b>46090-98A</b>		<b>\$24.95</b>
------------------	--	----------------

### C. H-D 20MM SUPER HARD WIRE CABLE LOCK<sup>1,2\*</sup>

This tempered steel cable lock features a smooth vinyl cover and a soft molded lock head to protect the frame and wheel from scratches. The braided and twisted cable offers improved cut resistance, and the integrated lock features a snap-shut cylinder with quarter-turn key movement. Orange highlights improve visibility for added theft deterrence. Kit includes 2 blade-style keys. "Key Safe" registration and replacement service is available. Cable length: 6.0'.

<b>46089-98A</b>		<b>\$64.95</b>
------------------	--	----------------

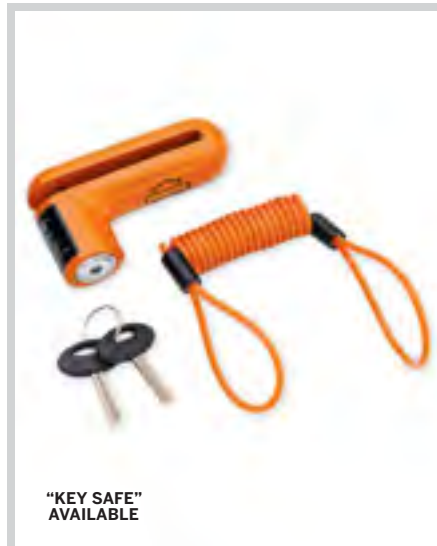

A. DISC BRAKE LOCK AND REMINDER CORD – ORANGE



A. DISC BRAKE LOCK AND REMINDER CORD – CHROME



B. H-D 12MM ACCESSORY CABLE LOCK



C. H-D 20MM SUPER HARD WIRE CABLE LOCK



<sup>1</sup> **WARNING:** Remove lock before operating motorcycle. Failure to remove lock could result in death or serious injury.



<sup>2</sup> **WARNING:** Chain or cable is to be used as a theft deterrent only. Use for towing, lifting, or any other purpose could result in death or serious injury.

\*\*"KEY SAFE" registration and replacement service is provided by the lock manufacturer. Information is included in the product packaging.

Notice: The prices appearing in this catalog are the manufacturer's suggested retail prices. Actual retail prices may vary.





"KEY SAFE"  
INCLUDED



**D. SHACKLE LOCK KIT**

**D. SHACKLE LOCK KIT<sup>1\*</sup>**

Secure your brake disc or sprocket. This lock features a fully removable 14mm shackle with a large inside diameter to simplify the capture of chain links and cable loops. The high-security double deadbolt design and anti-float disc lock cylinder is tough to defeat and the soft nylon coating on the shackle and lock protects your bike's finish. The blade-style key slot is hidden behind a sliding dust cover for weather protection and the kit includes a lighted key for nighttime locking. The bright orange color of the lock and the handy reminder cord provides visibility to the user and added theft deterrence. When not in use, the lock and cord can be stored in the compact ballistic nylon pouch with belt clip. Kit includes lock, two standard keys, one lighted key, coiled reminder cord and storage pouch.

- Includes Key Safe program that allows you to order keys if you lose them.
- Optional Anti-Theft protection that will pay up to \$750 if your bike is stolen.
- Thatcham Category 3 Approved.

**94868-10** **\$59.95**

**E. SECURITY CHAIN AND SHACKLE LOCK<sup>1,2\*</sup>**

This high-security Chain and Lock features a 12mm triple heat treated boron manganese 6-sided link steel chain, surrounded with an exclusive Bar & Shield logo nylon webbing to provide protection against scratched finishes. The lock features a fully removable 14mm shackle, a double deadbolt design for added security, a high-security lock cylinder with anti-float discs and nylon molded dust cover and a lighted key for nighttime locking. The orange color gives the lock greater visibility for added theft deterrence. Security chain length: 5.0'.

- Includes Key Safe program that allows you to order keys if you lose them.
- Optional Anti-Theft protection that will pay up to \$1000 if your bike is stolen.
- Thatcham Category 3 Approved.

**94872-10** **\$139.95**

**F. NOOSE CHAIN AND SHACKLE LOCK KIT<sup>1,2\*</sup>**

Maximum protection for your motorcycle. This high-security Noose Chain and Lock features a 12mm triple heat treated boron manganese 6-sided link steel chain with cinch ring for securing your bike to stationary objects. Put the chain around a post, slip the chain through the ring, and cinch it tight. Then loop the nylon-web covered chain through the frame or wheels of the bike and lock it up tight. The lock features a fully removable 14mm shackle, a double deadbolt design for added security, a high-security lock cylinder with anti-float discs and nylon molded dust cover, and a lighted key for nighttime locking. The orange color gives the lock greater visibility for added theft deterrence. Security chain length: 4.25'.

- Includes Key Safe program that allows you to order keys if you lose them.
- Optional Anti-Theft protection that will pay up to \$1000 if your bike is stolen.
- Thatcham Category 3 Approved.

**94869-10** **\$124.95**



"KEY SAFE"  
INCLUDED

**E. SECURITY CHAIN AND SHACKLE LOCK**



"KEY SAFE"  
INCLUDED

**F. NOOSE CHAIN AND SHACKLE LOCK KIT**

**⚠️<sup>1</sup>WARNING:** Remove lock before operating motorcycle. Failure to remove lock could result in death or serious injury.

**⚠️<sup>2</sup>WARNING:** Chain or cable is to be used as a theft deterrent only. Use for towing, lifting, or any other purpose could result in death or serious injury.

**\*\*"KEY SAFE"** registration and replacement service is provided by the lock manufacturer. Information is included in the product packaging.

*Notice: The prices appearing in this catalog are the manufacturer's suggested retail prices. Actual retail prices may vary.*

# 846 GARAGE

## Motorcycle Locks

### A. DOUBLE LOOPED SECURITY CABLE<sup>1</sup>

This handy 7' x 10mm Double Looped Cable is very versatile. The vinyl-covered braided cable is flexible, and can be used to lock equipment to your bike. Loop it through the sleeve of your jacket and the strap of your helmet, lock it to the bike, and feel free to walk away unencumbered. The bright orange swage covers provide greater visibility for added theft deterrence, and the hook-and-loop strap lets you tie the coiled cable for convenient storage. Cable length: 7.0'.

**94871-10**

**\$12.95**



**A. DOUBLE LOOPED SECURITY CABLE**

### B. HIGH SECURITY PADLOCK<sup>2</sup>

Premium quality, commercial grade padlock features a tough, hardened boron alloy shackle and dual ball bearing locking mechanism. Steel lock body is enclosed in high-tech black Xenoy<sup>®</sup>, offering exceptional weather resistance.

**45721-96A**

**\$34.95**



**B. HIGH SECURITY PADLOCK**

### C. BAR & SHIELD™ PADLOCK<sup>2</sup>

Classic round-body lock is perfect for use as a fork lock, or to secure protective cables or chains. This high-security lock features a tough case-hardened boron alloy shackle and easy-to-operate quarter-turn five-pin tumbler cylinder, housed in a beautiful chrome-plated lock body with textured surfaces and embossed Bar & Shield logo. Kit includes 2 keys.

**45737-72A**

**\$22.95**



**C. BAR & SHIELD PADLOCK**

### D. UNIVERSAL MOUNT HELMET LOCK<sup>2</sup>

To limit grab-and-run theft, just unlock the hinged clasp, hang your helmet by its strap, and relock with the included key. Your helmet is held securely in place. In addition, hanging your helmet reduces the risk of impact damage if the helmet slipped off the seat or the handlebar. Designed to be installed to .875" to 1.25" diameter tubing engine guards, saddlebag guards and frame tubes, the Helmet Lock is secured to the bike with tamper-proof hardware that cannot be easily removed. Note: Do not use lock when vehicle is in motion. Helmet Lock should only be used when motorcycle is parked and locked. Duplicate keys are not available.

**45732-86**

**\$27.95**

Fits all models. All VRSC™, '15-later XG and '04-later XL and XR models require installation of engine guard.



**D. UNIVERSAL MOUNT HELMET LOCK**

### E. HARLEY-DAVIDSON® HELMET LOCK<sup>2</sup>

This carabineer-style universal helmet lock protects your helmet, jacket or bag from casual grab-and-go theft. The lock is small enough to fit into your pocket, but big enough to fit around most any handlebar or engine guard (1.5"/38mm max). No keys are required. Simply set your own 4-digit code, slip the carabineer through your helmet D-ring, and close the outward-opening lock. The aluminum and zinc alloy carabineer is covered with a tough rubber coating to protect the surrounding finishes.

**52200003**

**\$24.95**

Universal.



**E. HARLEY-DAVIDSON HELMET LOCK**

### F. HARLEY-DAVIDSON HELMET/JACKET SECURITY CABLE<sup>1</sup>

This handy cable is a great complement to the Harley-Davidson Helmet Lock. Slide one end through your jacket sleeve or luggage, hook the loops at the end of the cable onto the Helmet Lock and attach it to your bike. And, if your helmet does not have D-rings, you can pass the cable through your helmet's chin piece, loop the ends through your Helmet Lock and lock it to your bike. Now your jacket, luggage and helmet are locked to your bike. When you're finished, it will recoil back to its original length and will slip easily into your pocket. The cable is made from 3mm thick nickel plated steel cable, is only 4.5 inches (11cm) long when coiled, stretches up to 6ft (180 cm) and has a load capacity of 200 lbs (100 kg).

**52200004**

**\$12.95**

Universal.



**F. HARLEY-DAVIDSON HELMET/JACKET SECURITY CABLE**



<sup>1</sup>**WARNING:** Chain or cable is to be used as a theft deterrent only. Use for towing, lifting, or any other purpose could result in death or serious injury.



<sup>2</sup>**WARNING:** Remove lock before operating motorcycle. Failure to remove lock could result in death or serious injury.

Notice: The prices appearing in this catalog are the manufacturer's suggested retail prices. Actual retail prices may vary.



### G. LOCKING H-D® DETACHABLES™ LATCH KIT

This unique lock replaces the cam-lock on your Harley-Davidson® Detachables accessories, providing additional security and peace-of-mind when parking your vehicle. Kit includes two extended-reach barrel-style keys for easy access to the lock. Key registration and replacement service is available. Sold in pairs.

Fits all models equipped with detachable Sideplates, Racks and Tour-Pak® Luggage Carriers (except '09-later Touring models equipped with detachable Solo Tour-Pak Rack).

<b>90300086</b>	Black.	<b>\$69.95</b>
<b>90300087</b>	Chrome.	<b>\$79.95</b>

### H. LOCKING QUICK-RELEASE WINDSHIELD CLAMP

Protect your investment. This Locking Quick-Release Windshield Clamp secures your windshield from grab-and-run theft, giving you peace of mind when you have to leave your bike unattended. The chrome-plated Locking Clamp replaces one of the Original Equipment windshield clamps, and features a push-button lock with a mini barrel-style key for easy removal. Kit includes one locking clamp and two matching keys.

**57400006** 39mm. **\$39.95**  
Fits '88-later XL and '91-'05 Dyna® models (except FXDWG) equipped with Quick-Release style windshields.

**57400007** 41mm. **\$29.95**  
Fits '93-'05 FXDWG and '88-later FXS, FXST, FXSTB and FXSTC models equipped with Quick-Release style windshields.

**57400008** 49mm. **\$41.95**  
Fits '02-'10 VRSCA and VRSCAW, '04-'05 VRSCB, '07 VRSCX and '06-later Dyna models (except FLD) equipped with Quick-Release style windshields.

### I. KEYED-TO-MATCH INDIVIDUAL REPLACEMENT LOCK PROGRAM

In the past, replacing a lock required the time and expense of re-keying a new lock or replacing all of the locks on your bike. Our Keyed-to-Match Program eliminates that hassle and allows you to order an exact replacement based on your lock's key code, right down to the quality you would expect from a stock Harley-Davidson® lock. Just ask your Dealer to refer to Bulletin Number 658B and they'll take care of your needs – lock, stock and barrel.

### J. KEYED-TO-MATCH CUSTOM KEYS

Custom keys make a statement. Keys can be ordered through your Harley-Davidson Dealer and will be keyed to match your ignition and fork lock and are delivered in a leatherette gift box.

#### 1. Commemorative CVO™ Ignition Key

Hand-polished brass key features a prismatic Bar & Shield logo set in a black field surrounded by "Custom Vehicle Operations™" script. Available to CVO™ vehicle owners only.

**71031-04** **\$89.95**

#### 2. Skull Ignition Keys

Key features the Harley-Davidson Skull logo in bright nickel with black accents.

**71040-04** Barrel Style. **\$74.95**

Fits '91-later models with barrel style key.

**71041-04** Blade Style. **\$74.95**

Fits '94-'11 XL models with blade style key.

#### 3. Bar & Shield Logo Ignition Keys

Key features the Harley-Davidson Bar & Shield logo with an antique brass finish. In time and with use the key will continue to develop a patina and character.

**71038-04** Barrel Style. **\$74.95**

Fits '91-later models with barrel style key.

**71039-04** Blade Style. **\$74.95**

Fits '94-'11 XL models with blade style key.



"KEY SAFE"  
AVAILABLE

G. LOCKING H-D DETACHABLES LATCH KIT – BLACK



"KEY SAFE"  
AVAILABLE

G. LOCKING H-D DETACHABLES LATCH KIT – CHROME



H. LOCKING QUICK-RELEASE WINDSHIELD CLAMP



I. KEYED-TO-MATCH INDIVIDUAL REPLACEMENT LOCK



J. KEYED-TO-MATCH CUSTOM KEYS

\*\*"KEY SAFE" registration and replacement service is provided by the lock manufacturer. Information is included in the product packaging.

Notice: The prices appearing in this catalog are the manufacturer's suggested retail prices. Actual retail prices may vary.

# 848 GARAGE

## Security Systems

### A. H-D® SMART SECURITY SYSTEM – '07-LATER MODELS

The H-D® Smart Security System offers automatic self-arming and hands-free disarming for vehicle electronic security functions for your '07-later Harley® motorcycle. The Hands-Free Fob communicates directly on its own unique and individualized frequency with the Hands-Free Security Module and Antenna. Attach the Hands-Free Fob to your vehicle ignition key ring. As you upright your vehicle or switch the ignition on, the Hands-Free Fob will communicate the Security System "disarm" command allowing you to start your vehicle. After riding your vehicle, park and switch the ignition off with your key. Within 5 seconds the Security System will automatically self-arm, disabling your vehicle starter, ignition and electronic fuel injection (EFI). The Smart Security System includes: Hands-Free Security Module (Integrated Security Sensor and Turn Signal Module or Body Control Module), 2 Hands-Free Fobs, Antenna Module, Antenna Harness and Antenna Mount (Dyna® models).

**Also available:**

**H-D SMART SECURITY SYSTEM HANDS-FREE FOB**  
Replacement/Additional Hands-Free Fob.

**68926-07** **\$44.95**

Fits '07-later models equipped with H-D Smart Security System. Requires activation. See your Harley-Davidson dealer.

**66000107** **\$3.95**  
CR2032 3v Lithium Replacement Battery.

### B. H-D FACTORY SECURITY SYSTEM – '06-EARLIER MODELS

Equip your '06-earlier Harley-Davidson® VRSC™, Sportster®, Dyna, Softail® or Touring model with the security system designed and approved by The Harley-Davidson Motor Company.

When armed, the Security System disables the starter and ignition while monitoring the electrical system and vehicle motion with adjustable sensitivity. Minor disturbances trigger a momentary warning; major ones, an unbroken thirty-second alarm, after which the Security System returns to monitoring. A distinctive four-way flasher pattern is the alarm signal. An optional self-powered Smart Siren Kit adds a piercing scream that sounds even if the battery cable is cut.

The Security System is armed and disarmed with a remote control waterproof key fob utilizing state-of-the-art rolling code technology. If the key fob is not available, the rider may arm or disarm the system by keying a previously entered personal code on the turn signal switches. Kit includes 1 Key Fob.

**Also available:**

**REPLACEMENT/ADDITIONAL REMOTE CONTROL WATERPROOF KEY FOB**

**68926-00** **\$44.95**

Fits models equipped with H-D Factory Security System, North America. Requires activation. See your Harley-Davidson dealer.

**68927-00** **\$44.95**

Fits models equipped with H-D Factory Security System, International (except Japan). Requires activation. See your Harley-Davidson dealer.

**Also available:**

**LITHIUM REPLACEMENT BATTERY – 3 VOLT**

Long-lasting, replaceable lithium coin-type battery for use in LED Temperature Dipsticks with Lighted LED Readout, Digital Touring Suspension Air Pump P/N 54000033 and Security Hands-Free Key Fob.

**66000107** **\$3.95**  
CR2032 3v Lithium Replacement Battery.



A. H-D SMART SECURITY SYSTEM – '07-LATER MODELS



A. H-D SMART SECURITY SYSTEM – '07-LATER MODELS  
(4100021C & 4100087B SHOWN)



A. H-D SMART SECURITY SYSTEM – '07-LATER MODELS  
(68200-07A, 68207-07A & 91684-08A SHOWN)



B. H-D FACTORY SECURITY SYSTEM – '06-EARLIER MODELS  
(68200-00D & 68207-00D SHOWN)

*Notice: The prices appearing in this catalog are the manufacturer's suggested retail prices. Actual retail prices may vary.*



### C. H-D® SECURITY SYSTEM SMART SIREN II

Security and convenience in one. The Harley-Davidson® Smart Siren II combines the functionality of the smart siren and pager transmitter into one easy-to-install unit. Featuring a built-in back-up power supply, the siren and transmitter functions will continue to operate even if the wires are cut or the vehicle battery is disconnected. When combined with the Pager Receiver II (*sold separately*), the integrated FM transmitter can warn of tampering up to 1/2 mile away. Smart Siren II features an enhanced sound chamber, a redesigned internal battery access cover, and ultra low power consumption during the standby mode. When activated, the Security System Fob arm and disarm commands are confirmed with a blink feature and '07-later models can be programmed to emit a chirp. Smart Siren II is certified for use in North America.

#### SMART SIREN BATTERY REPLACEMENT KIT (*not shown*)

Replacement Battery Kit for Harley-Davidson Factory Security System Smart Siren includes replacement nickel metal hydride battery and instructions.

**69309-10** **\$15.95**



**C. H-D SECURITY SYSTEM SMART SIREN II**

*Notice: The prices appearing in this catalog are the manufacturer's suggested retail prices. Actual retail prices may vary.*

### H-D SECURITY SYSTEMS, NORTH AMERICA

Model Family	Model Year	Security System		Smart Siren II Kit**	
VRSC™ (except VRSCF)	2007-later	68207-07A	\$339.95	68328-06A	\$94.95
VRSCF	2009-later	91684-08A	\$339.95	68328-06A	\$94.95
VRSC (except VRSCR)	2002-2006	68200-00D	\$299.95	68328-06A	\$94.95
VRSCR	2006	68207-00D	\$299.95	68328-06A	\$94.95
Trike	2009-2013	68200-07A	\$339.95	68328-06A	\$94.95
Touring and Trike	2014-later	41000087B	\$359.95	68328-06A	\$94.95
Touring	2007-2013	68200-07A*	\$339.95	68328-06A	\$94.95
Touring	2002-2006	68200-00D*	\$299.95	68328-06A	\$94.95
Touring	2000-2001	68200-00D*	\$299.95	68317-06A	\$129.95
Dyna®	2012-later	41000087B	\$359.95	68328-06A	\$94.95
Dyna	2007-2011	68207-07A	\$339.95	68328-06A	\$94.95
Dyna	2004-2006	68207-00D	\$299.95	68328-06A	\$94.95
Dyna	2000-2003	68200-00D	\$299.95	—	—
Softail®	2011-later	41000021C	\$359.95	68328-06A	\$94.95
Softail (except FXCW/C)	2007-2010	68207-07A	\$339.95	68328-06A	\$94.95
Softail FXCW/C	2008-2010	91684-08A	\$339.95	68328-06A	\$94.95
Softail	2003-2006	68207-00D	\$299.95	68328-06A	\$94.95
Softail	2000-2002	68207-00D	\$299.95	—	—
XL	2014-later	41000087B	\$359.95	68328-06A	\$94.95
XL/XR	2007-2013	68200-07A	\$339.95	68352-06B	\$129.95
XL	2004-2006	68200-00D	\$299.95	68352-06B	\$129.95

\*P/N 88115-03 Bank Angle Switch Kit (*sold separately*) or Security System P/N 68200-00D or 68200-07A are required for use on 2000-2013 FL Touring models equipped with a TLE/Ultra Sidecar.

\*\*Pager function requires Remote Pager Receiver II P/N 91660-06 or 91672-07 (*sold separately*).

# 850 GARAGE

Security & First Aid

## HARLEY-DAVIDSON® SECURITY SYSTEM PAGER RECEIVER II

Designed to complement the Smart Siren II, this Pager Receiver can be linked to the vehicle with no additional installation. The Pager Receiver II monitors the Security System operation, and features multi-color LED indicators to display unique codes for arming, disarming and trigger modes. The Range Confirmation Signal (RCS) confirms and displays the signal reception. High-efficiency FM circuitry provides excellent reception, even in buildings and parking garages. Maximum effective range is up to 1/2 mile. The Pager Receiver II features selectable vibration or audible modes. The silent paging mode feature allows selectable programming trigger modes to avoid activating the siren.

### A. PAGER RECEIVER II – BATTERY POWERED

The convenient built-in ultra-bright white LED flashlight helps light the way. The compact, lightweight receiver can be carried in your pocket, or the receiver holster can be clipped to a belt up to 1-3/4 inches wide. Kit includes receiver, holster, and one 3V lithium battery. Operates in conjunction with the Security System Fob and Smart Siren II.

**91660-06** **\$74.95**

Fits all models equipped with the Harley-Davidson® Security System Smart Siren II. Certified for use in North America.

**66378-06** **\$2.95**

CR2450 3v Lithium Replacement Battery.



A. HARLEY-DAVIDSON SECURITY SYSTEM PAGER RECEIVER II – BATTERY POWERED

### B. PAGER RECEIVER II – RECHARGEABLE

The compact, lightweight receiver can be carried in your pocket or clipped to a belt. Kit includes receiver and UL-listed battery charger (AC-DC with Output of DC 4.5V 50mA for North America). Operates in conjunction with the Security System Fob and Smart Siren II.

**91672-07** **\$89.95**

Fits all models equipped with the Harley-Davidson Security System Smart Siren II. Certified for use in North America.



B. HARLEY-DAVIDSON SECURITY SYSTEM PAGER RECEIVER II – RECHARGEABLE

### C. BIKER'S COMPACT FIRST AID KIT

Keep this simple first aid kit with you wherever you go. The compact 9.0" x 4.0" x 2.0" zippered nylon case is small enough to fit inside all Harley-Davidson windshield bags, and contains: burn cream packets, hand sanitizer packets, antibiotic packets, eyewash, gauze pads, plastic and flexi strips, gauze, waterproof tape, latex-free gloves, cleansing towelettes, insect sting pads, scissors, tweezers/magnifier, survival wrap, and an English-language quick first aid guide. Intended for U.S. market.

**93511-10** **\$29.95**



C. BIKER'S COMPACT FIRST AID KIT

Notice: The prices appearing in this catalog are the manufacturer's suggested retail prices. Actual retail prices may vary.





**D. COMPACT AIR COMPRESSOR WITH LIGHT**



**E. VALVE STEM EXTENSION**



**F. COMPACT TIRE GAUGE AND TREAD DEPTH INDICATOR**



**F. COMPACT TIRE GAUGE AND TREAD DEPTH INDICATOR WITH STAINLESS STEEL LEAD**



**G. DIGITAL TIRE PRESSURE GAUGE**



**H. TIRE GAUGE AND TREAD DEPTH INDICATOR WITH EMBOSSED LEATHER POUCH**

**D. COMPACT AIR COMPRESSOR WITH LIGHT**

Correct tire pressure is crucial to safe operation and long tire life, but checking the pressure, finding a gas station with a working air pump, and filling the tire is a chore that many of us ignore. Compact Air Compressor is designed to simplify this necessary procedure. The compact, lightweight 12V pump is designed for life on the road. The all-in-one pump plugs into your bike's battery charging harness, and features a built-in 0-160 psi pressure gauge and bright LED work light. The 11" air hose and 6' fuse-protected power cord easily reach the front and rear wheels, and are stored in convenient compartments when not in use. The lightweight pump features durable, impact-resistant construction, and is small enough to fit easily in a saddlebag or strap-on luggage. Kit includes pump, valve stem extension, and nylon carrying bag.

**12700020 \$40.95**

**E. VALVE STEM EXTENSION**

Sometimes there's just not enough space around the tire's valve stem for the gas station air chuck and hose to reach. Brake rotors, sprockets and saddlebags get in the way and keep the air chuck from making an airtight seal. When that happens, this Valve Stem Extension provides easy access. Simply screw the extension in place on the stem, fill the tire to the proper pressure, remove the extension, and replace the valve stem cap. Then toss the extension in your saddlebag or tool roll for the next time.

**42300009 \$10.95**

**F. COMPACT TIRE GAUGE AND TREAD DEPTH INDICATOR**

Combination dial air pressure and tread depth gauge provides easy access to the valve stem. A durable internal diaphragm provides accurate air pressure readings with a dual range indicator for 0-60 psi and 0-400 kPa readings. The pressure relief valve is activated by a push button to eliminate inner gauge air pressure after use. The integrated tire tread depth gauge features a dual-range color-coded indicator, calibrated in 1/32" (0-14/32") and millimeters (0-11mm), for monitoring tread wear. A protective rubber boot covers the housing to protect the gauge from impact and abrasion.

**75008-02A Compact. \$34.95**

**75137-98B \$39.95**

Compact with braided stainless steel lead.

**G. DIGITAL TIRE PRESSURE GAUGE**

Back-lit Digital Tire Pressure Gauge is easy to read at any time of day. Providing accurate pressure readings in 0.50 psi increments up to 60 psi. Scale can be changed to read psi, bar, Kg or kPa pressure with the touch of a button. This versatile gauge features a 12" braided line and 90 degree angle chuck for easy access to valve stems, and a tough rubber jacket to protect the gauge from damage. Batteries are included.

**75158-10 \$39.95**

**H. TIRE GAUGE AND TREAD DEPTH INDICATOR WITH EMBOSSED LEATHER POUCH**

Chrome-plated steel gauge housing with "Harley-Davidson" script and 90 degree air chuck. Dual range indicator for air pressure and tire tread depth readings. Calibrated for 10-50 psi and 0-32/32" tread depth readings. Rotate the indicator shaft 90 degrees in the housing for 70-345 kPa and 0-30mm tread depth readings. Complete with a Bar & Shield logo embossed leather pouch.

**75110-98B \$19.95**

Notice: The prices appearing in this catalog are the manufacturer's suggested retail prices. Actual retail prices may vary.

## 852 GARAGE

### Oil Change Accessories

#### A. LOW PROFILE OIL DRAIN PAN

Reduce the mess and cleanup required when changing the fluids on your motorcycle. This reusable Drain Pan is designed specifically for use with Harley-Davidson® motorcycles. The low-profile design fits easily under standard height and lowered motorcycles, and slips beneath the bike even when on the side stand. The 10-quart capacity pan will capture 2 engine oil changes, or the complete drain fluids (engine oil, primary and transmission) from one motorcycle. The Drain Pan is large enough to catch the oil from the entire length of the primary, and is sized to hold and drain an inverted primary cover. The Drain Pan features a raised hardware corral, a filter drain surface, and a pressure vent hole to prevent messy oil burping. The drained waste oil is sealed safely inside the pan with high-quality gasketed caps and plugs. Convenient carrying handle simplifies transport to an approved waste oil facility.

**63795-10** 10-Quart Capacity. **\$30.95**



OIL CHANGE ACCESSORIES



A. LOW PROFILE OIL DRAIN PAN

*Notice: The prices appearing in this catalog are the manufacturer's suggested retail prices. Actual retail prices may vary.*



# GARAGE 853

## Oil Change Accessories



**B. OIL FILTER WRENCH – END CAP STYLE**



**C. OIL FILTER REMOVAL WRENCH**

### **B. OIL FILTER WRENCH – END CAP STYLE**

Simplify oil filter removal and installation with this convenient End Cap Style Filter Wrench. The wrench grips the filter without crushing the canister, and allows the spin-on filter to be turned with a 3/8" drive socket wrench.

**94863-10** **\$10.95**  
For use with all H-D® spin-on oil filters (except '15- later XG).

### **C. OIL FILTER REMOVAL WRENCH**

This slip-resistant wrench, featuring a stainless steel band, is designed to make the removal of your oil filter much easier.

**94686-00** **\$10.95**  
Fits all models with spin-on oil filters (except '15- later XG).



**D. PRIMARY OIL FILL FUNNEL**



**E. TRANSMISSION/CRANKCASE FILL FUNNEL**

### **D. PRIMARY OIL FILL FUNNEL**

This reusable funnel makes it easy to add oil to your primary cavity. The funnel simply snaps into the derby cover opening to permit hands-free filling on the specified models. The convenient tab allows you to place the funnel in position with one hand, and the flat cone shape makes it easy to fill a tight area with no mess or spills. Smooth orange plastic surface is easy to clean after use.

**63797-10** **\$10.95**  
Fits '06-later Dyna®, and '07-later Softail®, Touring and Trike models.

**62700015** **\$10.95**  
Fits '84-'00 Evolution® 1340-equipped models, '99-'05 Dyna, '00-'06 Softail and '99-'06 Touring Twin Cam-equipped models.

### **E. TRANSMISSION/CRANKCASE FILL FUNNEL**

Fill your transmission and crankcase without the mess. This funnel is shaped to fit into tight spaces, and is designed to reach even the toughest access points. The anti-burp design ensures smooth oil flow, and the smooth orange plastic surface is easy to clean after use.

**63799-10** **\$4.95**



**F. ROAD FUNNEL**



### **F. ROAD FUNNEL**

This disposable folding funnel can be taken on the road and used for those times you need to replenish your bike's fluids. The funnel fits easily into your luggage, does not take up valuable storage space, and can be thrown away after use. Convenient tear-off 3-pack means you will always be prepared.

**97410-10** **\$1.95**

### **G. OIL CATCHER DRAIN OIL FUNNEL**

Avoid spilling oil onto your engine when removing the oil filter. The Oil Catcher Funnel slips below the filter, and provides access to spin the filter off its mount. Oil is captured in the funnel, and is siphoned into a bottle or catch basin through the drain tube. Smooth orange plastic surface is easy to clean after use.

**63794-10** **\$20.95**  
Fits '04-later XL, '08-'13 XR, '99-later Dyna and Touring and '09-later Trike models.



**G. OIL CATCHER DRAIN OIL FUNNEL**



*Notice: The prices appearing in this catalog are the manufacturer's suggested retail prices. Actual retail prices may vary.*

# 854 GARAGE

## Battery Chargers

### HARLEY-DAVIDSON® BATTERY TENDERS AND CHARGERS

Extend the life of your motorcycle battery with an easy-to-use Battery Charger or Battery Tender. Designed to maintain full charge during storage or between rides, all Harley-Davidson® Battery Chargers include quick-disconnect harnesses for simple plug-in connection.

#### A. 750mA SUPERSMART® BATTERY TENDER

*Typical Recharge Time: 8-12 hours*

Compact Battery Tender is superior to a traditional auto-parts store "trickle charger". The built-in "smart" circuitry cycles the charger to turn itself on and off as needed, so your battery never overcharges. Accepts North American voltage (120V), supplied with 2-prong un-polarized plug. Output is 12 VDC @ 750mA. Charger output lead is equipped with quick-disconnect black connectors. Kit includes a quick-disconnect 7.5 Amp fused Battery Charging Harness with ring terminals that can attach to the battery screw terminals for easy connection, and a 7.5 Amp fused alligator clip charging harness. 5-year manufacturer's warranty.

For 12-volt batteries.

**66000038** United States, Canada, Mexico and South America (except Argentina). **\$39.95**

#### B. 800mA WATERPROOF BATTERY TENDER

*Typical Recharge Time: 8-12 hours*

This waterproof, fully-automatic charger is ideal for both short term and seasonal storage, even if moisture sneaks into your storage area. The three-step charging system constantly monitors battery voltage to bring the battery up to full charge and switches to float mode to maintain the charge over extended periods of time. The vibration- and shock-resistant Battery Tender is reverse polarity protected and spark proof, even when the leads touch. The Tender features 2 front panel LED lamps that indicate the battery's state of charge. Accepts worldwide voltage 100 to 240 VAC @ 50 to 60 Hz. Maximum charge rate of 800mA. Kit includes a quick-disconnect 7.5 Amp fused Battery Charging Harness with ring terminals that can attach to the battery screw terminals for easy connection, and a 7.5 Amp fused alligator clip charging harness. 3-year manufacturer's warranty.

For 12-volt batteries.

**66000004** United States, Canada, Mexico and South America (except Argentina). **\$49.95**

**99814-09** Europe. **\$49.95**

**99816-09** United Kingdom. **\$49.95**

**99819-09** Australia. **\$49.95**





**99820-09** Japan. **\$49.95**



**A. 750mA SUPERSMART BATTERY TENDER**  
TYPICAL RECHARGE TIME: 8-12 HOURS



**B. 800mA WATERPROOF BATTERY TENDER**  
TYPICAL RECHARGE TIME: 8-12 HOURS

Global Battery Chargers Power Cord	Region	800mA P/N	1.25 AMPS P/N	5.0 AMPS P/N
 PLUG TYPE "A"	U.S., Canada, Mexico and South America (except Argentina)	66000004	66000033 99829-09 99847-09	66000041
 PLUG TYPE "C"	Europe	99814-09	N/A	66000042
 PLUG TYPE "G"	United Kingdom	99816-09	N/A	66000043
 PLUG TYPE "I"	Australia	99819-09	N/A	66000044
 PLUG TYPE "A"	Japan	99820-09	66000034	66000046

**GLOBAL BATTERY CHARGER POWER CORD MATRIX**

*Notice: The prices appearing in this catalog are the manufacturer's suggested retail prices. Actual retail prices may vary.*





**C. 1.25 AMP WEATHER-RESISTANT BATTERY CHARGER**  
TYPICAL RECHARGE TIME: 4-8 HOURS

**C. 1.25 AMP WEATHER-RESISTANT BATTERY CHARGER**

*Typical recharge time: 4-8 hours.*

Properly charge and maintain all H-D® 12-volt batteries. The advanced solid-state circuitry constantly monitors the battery's charge, and manages the voltage without overcharging. The charger automatically switches to float mode and adjusts the charge rate up or down to keep the battery properly maintained for extended periods of time. The weather resistant construction provides peace of mind in case of exposure to moisture during charging. Accepts worldwide voltage 100 to 240 VAC @ 50 to 60 Hz. Maximum charge rate of 1.25 Amperes. Kit includes a quick-disconnect 7.5 Amp fused Battery Charging Harness with ring terminals that can attach to the battery screw terminals for easy connection, and a 7.5 Amp fused alligator clip charging harness. 2-year manufacturer's warranty.

For 12-volt batteries.

<b>66000033</b>	United States, Canada, Mexico and South America (except Argentina).	<b>\$79.95</b>
<b>66000034</b>	Japan.	<b>\$79.95</b>



**D. 5 AMP WEATHER-RESISTANT BATTERY CHARGER**  
TYPICAL RECHARGE TIME: 1-2 HOURS

**D. 5 AMP WEATHER-RESISTANT BATTERY CHARGER**

*Typical recharge time: 1-2 hours.*

Professional charging performance in a compact package. With a typical recharge time of 1 to 2 hours, this charger features advanced solid-state circuitry that constantly monitors the battery's charge and maintains the voltage without overcharging. The charger automatically switches to float mode and adjusts the charge rate up or down to keep the battery properly maintained for extended periods of time. The weather resistant construction provides peace of mind in case of exposure to moisture during charging. Maximum output charge rate is 5.0 Amperes and is compatible with 2-pin or 3-pin charging harnesses. The charger accepts worldwide input voltage 100 to 240 VAC @ 50 to 60 Hz. Includes a specific power cord to accommodate regional variations in worldwide AC power configurations. Charger features output leads equipped with 2-pin quick-disconnect that is compatible with the 7.5 Amp fused alligator clip charging harness and the Battery Charging Harness with ring terminals (included). 2-year manufacturer's warranty.

For 12-volt batteries.

<b>66000041</b>	United States, Canada, Mexico and South America (except Argentina).	<b>\$129.95</b>
<b>66000042</b>	Europe.	<b>\$129.95</b>
<b>66000043</b>	United Kingdom.	<b>\$129.95</b>
<b>66000044</b>	Australia.	<b>\$129.95</b>
<b>66000046</b>	Japan.	<b>\$129.95</b>



**E. 1.25 AMP BATTERY CHARGING STATION**  
TYPICAL RECHARGE TIME: 4-8 HOURS

**E. 1.25 AMP BATTERY CHARGING STATION**

*Typical recharge time: 4-8 hours.*

Keep all your bikes fully charged and ready to ride. Harley-Davidson® Battery Charger Stations are designed to fully charge and maintain lead-acid motorcycle batteries, maintaining them at proper voltage. The 4-step SuperSmart® charging process (Initialization, Bulk, Absorption, Float) helps to prevent sulfation and reduces the effects of overcharging. Status indicator lights allow you to monitor the charging state of each connected battery. The Charging Station accepts worldwide voltage 100 to 240 VAC @ 50 to 60 Hz. Maximum charge rate of 1.25 Amperes.

The charger is spark proof and reverse polarity protected, and features short-circuit protection to prevent damage from incorrect terminal connections. The durable, light-weight Charging Station is portable, but can be wall-mounted for added convenience. Kit includes quick-disconnect 7.5 Amp fused Battery Charging Harness with ring terminals and 7.5 Amp fused alligator clip charging harness for each battery output. 2-year manufacturer's warranty.

For 12-volt batteries.

<b>1. 99829-09</b>	2 Bank, Charging Station.	<b>\$129.95</b>
<b>2. 99847-09</b>	4 Bank, Charging Station.	<b>\$249.95</b>

*Notice: The prices appearing in this catalog are the manufacturer's suggested retail prices. Actual retail prices may vary.*

# 856 GARAGE

## Battery Chargers

### A. BATTERY CHARGING HARNESS WITH LED CHARGE INDICATOR

A well-maintained battery can last 5+ years. This Battery Charging Harness simplifies charging the battery, and features an integrated LED indicator light that illuminates when your battery voltage drops to a level that requires charging. Just attach the ring terminals to your battery and route the harness for easy access to the plug connector. When the LED glows, it's time to connect the bike to a Harley-Davidson® Battery Tender. Compatible with all Harley-Davidson Battery Chargers, the harness features in-line 7.5 Amp fuse protection, and the plug connector is protected with a weather-shield cap when not in use.

**66000005** **\$14.95**  
Fits Harley-Davidson 12-volt batteries.



A. BATTERY CHARGING HARNESS WITH LED CHARGE INDICATOR

### B. BATTERY CHARGING HARNESS

Heavy-duty Battery Charging Harness with ring terminals and in-line 7.5 Amp fuse protection for attachment to a Harley-Davidson 12-volt battery. The wiring harness utilizes a plug connector that is compatible with all Harley-Davidson Battery Chargers equipped with black connectors. The ring terminals are attached to the battery with the harness routed to allow access for the plug connector attachment to a H-D® Battery Charger. The harness plug connector is protected with an attached weather-shield cap when not in use.

**94624-97B** Fits Harley-Davidson 12-volt batteries. **\$8.95**

### C. BATTERY CHARGING EXTENSION LEAD

Is your motorcycle parking spot too far from your garage electrical outlet? Extend the reach of your Harley-Davidson Battery Charger with these convenient Extension Leads. Low-loss leads feature the same quick-disconnect 2-prong plugs as found on the charger unit and the available charging harnesses.

For use with most Harley-Davidson Battery Chargers.

**99821-09** 12.5' **\$14.95**  
**99828-09** 25' **\$19.95**



B. BATTERY CHARGING HARNESS

C. BATTERY CHARGING EXTENSION LEAD

### D. DIGITAL TOURING SUSPENSION AIR PUMP

Adjust air pressure in your Touring shocks anywhere on the road. This easy-to-adjust Digital Air Pump has a digital display for checking and altering pressure in the rear air shocks on all Touring motorcycles. Gauge can also be used to measure air pressure in your tires. Features "Micro bleed" valve that allows precise adjustment of air pressure, and the "no loss" air connector maintains shock pressure when the fitting is removed. Display units can easily be changed between PSI and KPa. The LCD readout operates on a long-lasting, replaceable lithium coin-type battery (CR2032 3V, P/N 66000107).

**54000033** **\$69.95**  
For use with Touring air suspension components.



D. DIGITAL TOURING SUSPENSION AIR PUMP

*Notice: The prices appearing in this catalog are the manufacturer's suggested retail prices. Actual retail prices may vary.*





**E. RECHARGEABLE LED CIGARETTE LIGHTER FLASHLIGHT**



**E. RECHARGEABLE LED CIGARETTE LIGHTER FLASHLIGHT**

Now you don't need batteries to see the light. Always charged and at your fingertips, the Cigarette Lighter Flashlight fits into any Harley-Davidson® "cigarette lighter" style power outlet or 12-volt power supply. Powerful LED 15 Lumen lamp projects a brilliant pool of blue-white light that illuminates your work area and grabs attention in the dark. Light features safety strobe setting to ensure that you are seen from a distance.

**12700022**

**\$29.95**



**F. TACTICAL LED FLASHLIGHT WITH SAFETY STROBE**



**F. TACTICAL LED FLASHLIGHT WITH SAFETY STROBE**

The Tactical LED Flashlight with Safety Strobe won't leave you in the dark. The compact flashlight features 3 settings – high, low and strobe – plus an adjustable lens to focus the light from a narrow beam to a wide flood of light. Powered by standard AAA batteries, the flashlight's high beam reaches 140 yards (at 100 lumens), and the power-conserving low beam will last 50 continuous hours. The safety strobe will ensure that you are seen from a distance. Simple push-button operation changes modes quickly.

**12700024**

**\$49.95**



**G. LED PENLIGHT**



**G. LED PENLIGHT**

This durable compact LED Penlight features brilliant long-life LED lamps and a removable fiber optic pointer to help focus light into tight spaces. Powered by 2 standard AAA batteries, the LED Penlight produces 15 lumens of clean blue/white light, and will operate for up to 10 hours.

**12700025**

**\$21.95**



**H. SCREAMIN' EAGLE NUT GRABBER LIGHTED PICK-UP TOOL KIT**



**H. SCREAMIN' EAGLE® NUT GRABBER LIGHTED PICK-UP TOOL KIT**

Make picking up hard-to-get-to dropped nuts and bolts an easier task with these unique pick-up tools. Both tools feature illuminated tips for working in low-light areas, with LED lamps that are brighter, more durable, and longer lasting than traditional bulbs.

The lighted Claw Tool features a 22" flexible reaching arm that is tipped with an expanding four-finger gripping claw. Easy to operate with one hand, you just push the plunger to open the jaw and grip the object, and then release to grab. The bright tip-mounted LED lamp automatically switches on to help you search in low-light areas. Claw can retrieve objects up to 5 lb.

The Magnetic Flashlight features a flexible telescopic arm that extends 20" to reach into deep, tight areas. The powerful magnetic tip can retrieve objects up to 3 lb. To help find objects in low-light areas, the flexible tool is attached to a powerful LED flashlight that illuminates the magnetic tip. You can easily manipulate the tool and light with one hand.

**94148-10**

**\$19.95**

*Notice: The prices appearing in this catalog are the manufacturer's suggested retail prices. Actual retail prices may vary.*

# 858 GARAGE

## Tools

### A. HARLEY-DAVIDSON® PREMIUM TOOL KIT

This Premium Harley-Davidson® branded Tool Kit features all the tools you need for common maintenance on your motorcycle. The heavy-duty tools are conveniently secured in a hinged carrying case, and lock in place for simple organization. Tools feature large, easy-to-read size indicators, and are stamped with the classic Harley-Davidson script. Lifetime warranty.

#### 64-Piece Kit includes:

- 1 – Quick-Release Ratchet (3/8" Drive)
- 1 – 3" Extension (3/8" Drive)
- 1 – 6" Extension (3/8" Drive)
- 1 – Universal Joint (3/8" Drive)
- 11 – SAE Deep Sockets 3/8" – 1" (3/8" Drive)
- 8 – Metric Deep Sockets 10mm – 17mm (3/8" Drive)
- 1 – Spark Plug Socket 5/8" (3/8" Drive)
- 6 – Hex Sockets 1/8" – 3/8" (3/8" Drive)
- 6 – Torx® Sockets T25-T50 (3/8" Drive)
- 2 – Spinner Handle (1/4" Drive) with Adaptor
- 6 – Bits (Slotted, Phillips, Torx)
- 9 – SAE Combination Wrenches 1/4" – 3/4"
- 8 – Metric Combination Wrenches 8mm – 17mm
- 1 – Diagonal Pliers – 7"
- 1 – Slip Joint Pliers – 8"
- 1 – Needle Nose Pliers – 8"

**14900033** **\$274.95**

### B. HARLEY-DAVIDSON/SNAP-ON® TOOL KITS

These tool kits were developed specifically for Harley-Davidson by Snap-on® to perform the most functions with the least amount of tools and weight. Provides all the right tools, without compromising quality or damaging your motorcycle's hardware. Lifetime warranty.

#### H-D®/Snap-on Compact Tool Kit

Designed to provide the most tools in the least amount of space, this tool kit rolls into a compact pouch for easy transport.

**94684-00A** **\$219.95**  
Fits '00-later models (except FXR4, VRSC™ and XG models).

#### H-D/Snap-on Softail® Tool Kit

Tailored to the Softail® motorcycle, this high-quality tool kit is compact to take anywhere, and shaped to fit Softail models equipped with teardrop-shaped tool box.

**94668-00** **\$184.95**  
Fits '00-later Softail models.

### C. HARLEY-DAVIDSON TOOL KIT

This is the ideal carry-along tool kit for your Harley-Davidson motorcycle. The kit was developed to perform most service functions and weigh as little as possible to keep your load light.

**94819-02** **\$84.95**  
Fits '86-later XL, XR and '99-later Twin Cam-equipped models.

### D. TOOL KIT FOR VRSC™ MODELS

Designed specifically for the V-Rod® motorcycle, this is the ideal carry-along tool kit for your VRSC model. The kit includes the metric tools required to perform most service functions with the least amount of carrying weight.

**94820-02** **\$89.95**  
Fits '02-later VRSC models.



A. HARLEY-DAVIDSON PREMIUM TOOL KIT



B. H-D/SNAP-ON COMPACT TOOL KIT ('00-LATER MODELS SHOWN)



B. H-D/SNAP-ON SOFTAIL TOOL KIT ('00-LATER SOFTAIL MODELS SHOWN)



C. HARLEY-DAVIDSON TOOL KIT



D. TOOL KIT FOR VRSC MODELS

Notice: The prices appearing in this catalog are the manufacturer's suggested retail prices. Actual retail prices may vary.





**E. ALL-IN-ONE FOLDING TOOL**



**F. 8-IN-1 SCREWDRIVER**

**E. ALL-IN-ONE FOLDING TOOL**

This kit is the ideal traveling companion. Standard on the Ultra Classic® and Limited Electra Glide® model, this compact folding tool is equipped to perform the basic "on-the-road" service functions on most late-model Harley-Davidson® motorcycles. Large comfortable handle with a soft grip adds leverage, and holds the foldaway tools. Tool selection: Torx® bits – T27, T40; Hex Bits – 3/32", 1/4", 3/8"; Screwdriver Bits – Phillips, slotted; Open end wrenches (2) – 9/16", 1/2", 10mm. Kit includes nylon pouch with hook-and-loop closure and Bar & Shield logo.

**94435-10** **\$40.95**  
Fits '02-later models (except VRSC™ and XG models).

**F. 8-IN-1 SCREWDRIVER**

Ideal tool for most of the screws on H-D® products. The unique 8-in-1 design conveniently stores all fittings within handle. Included are #40, 30, 27, and 25 Torx, #2 and 3 Phillips and 2 slotted driver bits. Quality engineered by Snap-on® with lifetime guarantee against breakage.

**94669-00** **\$20.95**

**G. COMBINATION AXLE WRENCH**

Individual combination front and rear axle wrenches available for your model.

**1. 94695-08** .75" & 36mm. **\$17.95**  
Fits '02-'07 Touring models.

**2. 94697-08** .9375" & 36mm. **\$16.95**  
Fits '08-later Dyna®, Softail® and Touring models.

**H. SHOCK ADJUSTMENT SPANNER**

The Universal Spanner is small enough to carry in a H-D Tool Kit, and is designed to adjust the spring load on all mechanically adjustable H-D rear shock absorbers.

**94448-82B** **\$11.95**  
For use on models with mechanically adjustable H-D rear shock absorbers (except XR models).

**I. BELT TENSION TESTER TOOL**

Use to check tension on secondary belt.

**40006-85** Universal. **\$34.95**

**J. STAINLESS STEEL TRAYS WITH MAGNETIC BASE**

Convenient storage tray with a magnetic base secures small metallic parts during maintenance. Use it horizontally, vertically or upside down. The magnetic base is covered with a protective coating to prevent damage to surface finishes.

**94821-01** 4" Diameter. **\$9.95**

**94793-01** 6" Diameter. **\$11.95**

**K. ENGINE ASSEMBLY/DISPLAY STAND**

This dual purpose engine stand provides support to the Twin Cam Alpha (Dyna/Touring) crankcase during engine tear-down and assembly, and also provides a means to display the completed engine. Heavy-duty steel stand can be used free-standing on its non-marking rubber feet, or bolted to the bench for added stability. Stand features a laser-cut Bar & Shield logo.

**94845-10** **\$59.95**  
For use with Twin Cam Dyna, Touring and Trike engines.



**G. COMBINATION AXLE WRENCH**



**H. SHOCK ADJUSTMENT SPANNER**



**I. BELT TENSION TESTER TOOL**



**J. STAINLESS STEEL TRAYS WITH MAGNETIC BASE**



**K. ENGINE ASSEMBLY/DISPLAY STAND (SHOWN WITH OPTIONAL MAGNETIC HARDWARE TRAY)**



Notice: The prices appearing in this catalog are the manufacturer's suggested retail prices. Actual retail prices may vary.

# BODYGUARD IN A BOTTLE

Introducing a breakthrough in powertrain protection – Screamin' Eagle® SYN3® Full Synthetic Motorcycle Lubricant. For use in engines, transmissions and primary chain-cases, it's just the latest in a line of products formulated specifically to keep your Harley® motorcycle running strong, mile after mile.



## ENGINE OIL FAQ'S

### HOW OFTEN SHOULD I CHANGE MY MOTORCYCLE ENGINE OIL?

You should change your motorcycle engine oil and engine oil filter at the first 1,000-mile service interval and at every 5,000-mile service interval thereafter. If you ride your motorcycle hard, under dusty conditions, or in cold weather, the engine oil and filter should be changed more often. You should always change your engine oil and filter prior to winter storage (or any extended storage) so that your engine oil is clean and free of contaminants during this time period.

### CAN I GO LONGER BETWEEN OIL CHANGES BY CHANGING THE FILTER?

NO! The job of the oil filter is to remove dust, soot and other solid matter. Filters cannot remove water, gasoline or acids and cannot do the job of oil additives that have been used up. You should change your oil filter at the first 1,000-mile service interval and at every 5,000-mile service interval thereafter or prior to winter or extended storage periods.

### WHAT VISCOSITY GRADE SHOULD I USE IN MY HARLEY MOTORCYCLE?

The recommended viscosity grade for all temperature conditions is SAE 20W50 Harley-Davidson® Motor Oil. SAE 10W40 H-D® Motorcycle Oil is also available and appropriate for low temperature climates. The SAE 50 H-D Motorcycle Oil is satisfactory in ambient temperatures of 60-80°F, and the SAE 60 H-D Motorcycle Oil in ambient temperatures above 80°F. SAE 20W50 covers the broadest range of operating temperatures.

0°F -18°C	20°F -6°C	40°F 4°C	60°F 16°C	80°F 27°C	100°F 38°C
SYN 3					
HD360 20W50					
HD360 10W40		HD360 SAE50		HD360 SAE60	

## SYN3® ENGINE, PRIMARY AND TRANSMISSION OIL FAQ'S

### WHAT ARE THE KEY BENEFITS TO USING SYN3 MOTORCYCLE LUBRICANT?

- SYN3® Lubricant offers improved film strength for superior wear protection at high temperatures, and improved deposit control for a cleaner engine, transmission, and primary chaincase.
- SYN3 Lubricant can be used in the engine, primary chaincase, and transmission.
- SYN3 Lubricant is formulated for reduced oil consumption, improved wear protection, high-temperature stability, and superior overall field performance.

### WHAT'S THE DIFFERENCE BETWEEN SYNTHETIC AND PETROLEUM-BASED LUBRICANTS?

Both synthetic and petroleum-based lubricants are derived from the same crude oils. But that's pretty much where the similarities end. Unlike their petroleum-based counterparts, which inherit physical components (including contaminants) of the source crude oil in the refining process, synthetic lubricants are manufactured from basestocks that are custom-designed from scratch to have desired properties for specific purposes, meaning that engineers have complete control of the lubricant from start to finish – at the molecular level.

### WHAT DOES SYN3 FULL SYNTHETIC MOTORCYCLE LUBRICANT DO FOR MY DRIVETRAIN?

SYN3 Full Synthetic Motorcycle Lubricant offers all the benefits of Genuine Harley-Davidson 360 Motorcycle Oil, and:

- Offers superior wear protection at higher temperatures
- Keeps engines, transmissions and primary chaincases cleaner
- Meets the anti-wear lubricity requirements of all transmission gears
- Lubricates all primary chaincase components
- Delivers smooth, sure clutch operation
- Provides long-term protection of all internal components
- Improves seal and gasket performance
- Offers superior performance in high-output engines

### WHEN CAN I START USING SYN3 FULL SYNTHETIC MOTORCYCLE LUBRICANT?

Right away. SYN3 Full Synthetic Motorcycle Lubricant is approved for all stages of engine life, including the first service interval – which means it's not detrimental to engine break-in. You can even use it as a first fill upon delivery of a new motorcycle.

### SINCE SYN3 FULL SYNTHETIC MOTORCYCLE LUBRICANT IS A HIGH-PERFORMANCE LUBRICANT, CAN I WAIT LONGER BETWEEN CHANGES?

No. As with petroleum-based engine lubricants, you should drain and replace the synthetic motorcycle lubricant in your engine at every 5,000-mile service interval. You should also change your oil filter anytime the engine lubricant is changed. If you ride your motorcycle hard, under dusty conditions, or in cold weather, you should change your SYN3 Synthetic Motorcycle Lubricant and oil filter more often. You should always change your engine lubricant and filter prior to any extended storage so that your engine is clean and free of any contaminants during this time.

### TESTED-CERTIFIED SYN3 SERVICE INTERVALS:

#### Primary Chaincase

'84-later Big Twin models with wet-type diaphragm spring clutch. *Every 10,000 miles, or prior to winter or extended storage periods.*

#### Transmission

All Big Twin models. *Every 20,000 miles, or prior to winter or extended storage periods.*

#### Transmission

'70-earlier XL and K models. *Every 10,000 miles, or prior to winter or extended storage periods.*

#### Primary/Transmission

'71-later XL and '83-'84 XR1000™ models. *Every 10,000 miles, or prior to winter or extended storage periods.*





**A. SCREAMIN' EAGLE SYN3 FULL SYNTHETIC MOTORCYCLE LUBRICANT**

**A. SCREAMIN' EAGLE® SYN3® FULL SYNTHETIC MOTORCYCLE LUBRICANT**

TESTED-CERTIFIED for use in Harley-Davidson® engine, primary chaincase and transmission applications, Screamin' Eagle® SYN3® Full Synthetic Lubricant makes changing and topping off fluids a simple, one-product process. Developed with a proprietary three synthetic basestock formula, Screamin' Eagle SYN3 Lubricant is formulated to provide for long-term protection and engine cleanliness requirements, and to provide superior high-temperature protection for high-output engines. SYN3 Lubricant is formulated to maintain the coefficient of friction for proper clutch operation and to provide the proper lubrication to the primary chain drive. In addition, SYN3 Lubricant is designed to provide the correct lubricity for the anti-wear requirements of transmission gears and for improved seal protection. This formula is approved by Harley-Davidson for use in all stages of engine life and is not detrimental to the break-in stage of engines.

Formulated for use in Harley-Davidson engines, transmissions and the following primary chaincase applications: '71-later XL, '83-'84 XR1000, '08-'13 XR and '84-later Big Twin models with wet-type diaphragm spring clutch.

United States		
<b>62600005</b>	SAE 20W50 – 1 Quart.	<b>\$12.95</b>
<b>62600031</b>	SAE 20W50 – 1 Gallon.	<b>\$48.95</b>
Canada		
<b>62600011</b>	SAE 20W50 – 1 Liter.	<b>\$12.95</b>
<b>62600030</b>	SAE 20W50 – 4 Liter.	<b>\$48.95</b>
Europe/Latin America		
<b>62600015</b>	SAE 20W50 – 1 Liter.	<b>\$12.95</b>
Asia/Pacific		
<b>62600021</b>	SAE 20W50 – 1 Quart.	<b>\$12.95</b>
<b>62600059</b>	SAE 20W50 – 1 Gallon.	<b>\$48.95</b>

**B. GENUINE HARLEY-DAVIDSON H-D® 360 MOTORCYCLE OIL**

Harley-Davidson Genuine H-D® 360 Motorcycle Oil is developed and tested for use in Harley-Davidson motorcycles. Our unique additive package helps prevent engine wear and helps keep your engine cooler, cleaner, and free of sludge, varnish and corrosion.

Harley-Davidson air-cooled V-Twin motorcycles operate at higher temperatures than water-cooled engines, thus a specific high temperature additive package is necessary to protect the engine. Be assured, H-D 360 Oil can be trusted in a Harley-Davidson engine.

Available in SAE 10W40, 20W50, SAE 50, and SAE 60. Refer to your Harley-Davidson owner's manual for the proper SAE grade recommendation based on the climate and temperature range you ride in.

United States		
<b>62600053</b>	SAE 10W40 – 1 Quart.	<b>\$7.49</b>
<b>62600007</b>	SAE 20W50 – 1 Quart.	<b>\$7.49</b>
<b>62600038</b>	SAE 20W50 – 1 Gallon.	<b>\$29.95</b>
<b>62600008</b>	SAE 50 – 1 Quart.	<b>\$7.49</b>
<b>62600009</b>	SAE 60 – 1 Quart.	<b>\$7.49</b>
Canada		
<b>62600056</b>	SAE 10W40 – 1 Liter.	<b>\$7.49</b>
<b>62600013</b>	SAE 20W50 – 1 Liter.	<b>\$7.49</b>
<b>62600041</b>	SAE 20W50 – 4 Liter.	<b>\$29.95</b>
<b>62600014</b>	SAE 50 – 1 Liter.	<b>\$7.49</b>
Europe/Latin America		
<b>62600055</b>	SAE 10W40 – 1 Liter.	<b>\$7.49</b>
<b>62600017</b>	SAE 20W50 – 1 Liter.	<b>\$7.49</b>
<b>62600042</b>	SAE 20W50 – 4 Liter.	<b>\$29.95</b>
<b>62600018</b>	SAE 50 – 1 Liter.	<b>\$7.49</b>
<b>62600061</b>	SAE 60 – 1 Liter.	<b>\$7.49</b>
Asia/Pacific		
<b>62600054</b>	SAE 10W40 – 1 Quart.	<b>\$7.49</b>
<b>62600023</b>	SAE 20W50 – 1 Quart.	<b>\$7.49</b>
<b>62600043</b>	SAE 20W50 – 1 Gallon.	<b>\$29.95</b>
<b>62600024</b>	SAE 50 – 1 Quart.	<b>\$7.49</b>
<b>62600060</b>	SAE 60 – 1 Quart.	<b>\$7.49</b>



**B. GENUINE HARLEY-DAVIDSON H-D 360 MOTORCYCLE OIL**

Notice: The prices appearing in this catalog are the manufacturer's suggested retail prices. Actual retail prices may vary.

# 862 GARAGE

Oil & Lube

## A. FORMULA+ TRANSMISSION AND PRIMARY CHAINCASE LUBRICANT

Developed with a proprietary mineral basestock formula and TESTED-CERTIFIED by Harley-Davidson Motor Company, Formula+ is blended to provide lubricity for the anti-wear requirements of transmission gears. Formulated to maintain the coefficient of friction for proper clutch operation and provide adequate lubrication to the primary chain, this lubricant is approved for use in all stages of transmission and primary chaincase life. Not for use in the crankcase as a motor oil.

TESTED-CERTIFIED Extended Service intervals:

### Primary Chaincase

'84-later Big Twin models with wet-type diaphragm spring clutch. Every 10,000 miles, or prior to winter or extended storage periods.

### Transmission

All Big Twin models. Every 20,000 miles, or prior to winter or extended storage periods.

### Primary/Transmission

'71-later XL and '83-'84 XR1000 models. Every 10,000 miles, or prior to winter or extended storage periods.

Formulated for use in Harley-Davidson® Transmissions and the following Primary Chaincase applications: '71-later XL, '83-'84 XR1000, '08-'13 XR, and '84-later Big Twin models with wet type diaphragm spring clutch. Not for use in '02-later VRSC™ or '15-later XG models.

<b>62600004</b>	1 Quart – U.S.	<b>\$8.95</b>
<b>62600010</b>	1 Liter – Canada.	<b>\$8.95</b>
<b>62600019</b>	1 Liter – Europe.	<b>\$8.95</b>
<b>62600033</b>	1 Quart – Asia/Pacific.	<b>\$8.95</b>

## B. HARLEY-DAVIDSON FORK OIL

Refer to Owner's Manual for required type.

<b>62600025</b>	Type B. 16 fl oz (473 ml) Bottle.	<b>\$7.95</b>
<b>62600026</b>	Type E. 16 fl oz (473 ml) Bottle.	<b>\$7.95</b>

## C. BIG PISTON FORK OIL

Blended specifically for '10-'13 XR1200X™ suspension.

<b>99885-10</b>	16 fl oz (473 ml) Bottle.	<b>\$29.95</b>
-----------------	---------------------------	----------------

## D. SCREAMIN' EAGLE® PERFORMANCE FORK OIL

A heavier blended oil that provides extra damping in performance applications.

<b>62600027</b>	16 fl oz (473 ml) Bottle.	<b>\$7.95</b>
-----------------	---------------------------	---------------

## E. DOT 5 BRAKE FLUID

For use in all models (except '06-later VRSC™, '07-later XL, '08-later XR, '06-later Dyna® and Softail® and '05-later Touring and Trike models).

<b>41800220</b>	12 fl oz (355 ml) Bottle.	<b>\$12.95</b>
-----------------	---------------------------	----------------

## F. DOT 4 BRAKE FLUID

For use in all '06-later VRSC, '15-later XG, '07-later XL, '08-later XR, '06-later Dyna and Softail and '05-later Touring and Trike models.

<b>41800219</b>	12 fl oz (355 ml) Bottle.	<b>\$7.95</b>
-----------------	---------------------------	---------------

## G. ETHANOL GUARD FUEL STABILIZER

Ideal for winter storage and year-round use, this premium Fuel Stabilizer keeps fuel fresh for up to 12 months. Blended with corrosion inhibitors, this Fuel Stabilizer is formulated to protect fuel tanks, fuel lines, carburetors and injectors from long-term exposure to the adverse affects of ethanol-blended fuel. It fights deposits that can accumulate as a result of ethanol-produced solvents, and acts as a demulsifier to eliminate condensation in your fuel system. 4 ounces treats 10 gallons of fuel.

<b>91600001</b>	4 fl oz (118 ml) Bottle.	<b>\$5.95</b>
-----------------	--------------------------	---------------



A. FORMULA+ TRANSMISSION AND PRIMARY CHAINCASE LUBRICANT



B. HARLEY-DAVIDSON FORK OIL



C. BIG PISTON FORK OIL



D. SCREAMIN' EAGLE PERFORMANCE FORK OIL



E. DOT 5 BRAKE FLUID



F. DOT 4 BRAKE FLUID



G. ETHANOL GUARD FUEL STABILIZER

Notice: The prices appearing in this catalog are the manufacturer's suggested retail prices. Actual retail prices may vary.





**H. GENUINE HARLEY-DAVIDSON EXTENDED LIFE ANTIFREEZE AND COOLANT**



**I. SCREAMIN' EAGLE ASSEMBLY LUBE**

**H. GENUINE HARLEY-DAVIDSON® EXTENDED LIFE ANTIFREEZE AND COOLANT**

Antifreeze is pre-diluted with deionized water to eliminate cooling system contamination. Formulated to use at full strength (*do not add water*), this coolant provides exceptional heat transfer properties. Protects the entire cooling system against corrosion. Formula is silicate-free, phosphate-free, nitrate-free and borate-free. One gallon container.

**99822-02** One gallon container. **\$22.95**  
For use in VRSC™, XG, and Twin-Cooled™ models.

**I. SCREAMIN' EAGLE® ASSEMBLY LUBE**

Screamin' Eagle® Assembly Lube provides superior protection during installation or servicing of internal engine components. Formulated with a high tackifier, this lubricant clings to parts and provides excellent start-up and break-in protection. It provides excellent corrosion resistance, and it won't drip off like common oil when you set coated parts aside to work on the rest of the engine. That's why we use it on all of our test engines. Don't start your re-built or serviced engine without it. Recommended applications: cams, gears, crankpins, piston wrist pins, oil pumps, valve guides, rocker arm and push rod tips, and roller tappet wheels. In addition, this product replaces H-D® Poly Oil and is recommended for the engine compensator sprocket on primary belt drive models.

**11300002** 4 fl oz (118 ml) Tube. **\$10.95**

**J. SPECIAL PURPOSE GREASE**

Factory approved steering head bearing lubricant for '97-later Touring, Trike, Dyna®, and Softail® (except Springer™), '05-later XL & XR, '02-later VRSC and '15-later XG models. Do not use on wheel bearings.

**99857-97A** 14 oz (409 g) Grease Gun Cartridge. **\$10.95**

**K. WHEEL BEARING GREASE**

Recommended for wheel bearings and rear swingarm bearings.

**99855-89** 16 oz (454 g) Can. **\$9.95**

**99856-92** 14 oz (409 g) Grease Gun Cartridge. **\$8.95**

**L. FORK SEAL GREASE**

Required for service of fork seals.

**11300005** 1 oz (28 g) Tube. **\$11.95**

**M. HIGH PERFORMANCE CHAIN LUBE PLUS**

High Performance Chain Lube cleans as it protects. Can also be used on O-ring chains.

**93600005** 12 oz (340 g) Aerosol Can. **\$9.95**



**J. SPECIAL PURPOSE GREASE**



**K. WHEEL BEARING GREASE**



**L. FORK SEAL GREASE**



**M. HIGH PERFORMANCE CHAIN LUBE PLUS**

Notice: The prices appearing in this catalog are the manufacturer's suggested retail prices. Actual retail prices may vary.

# 864 GARAGE

Oil, Lube & Solvents

## A. HARLEY® AEROSOL LUBE

Harley® Lube is a Harley-Davidson approved general lubrication oil that is perfect for lubricating clutch cables, Tour-Pak® hinges, hand levers, footboards, footpegs, and windshield clamps. Aerosol container provides fast delivery of lubricant, and reduces cable lubrication time by 50%.

**93600113** 10.5 oz (297 g) Aerosol Can. **\$9.95**

## B. HARLEY LUBE

Harley Lube is a Harley-Davidson approved general lubrication oil that is perfect for lubricating clutch cables, Tour-Pak hinges, hand levers, footboards, footpegs, and windshield clamps. Handy needle dispenser for precision application.

**94968-09** .25 fl oz (7.5 ml) Tube. **\$5.95**

## C. ELECTRICAL CONTACT LUBRICANT

Ideal for use on multi-pin connectors, bulb bases, and battery terminals, this specially formulated Electrical Contact Lubricant offers excellent film strength that is resistant to water (including salt water). Prevents fretting corrosion in connectors that often occurs with temperature variations and vibration. Safe for use on tin, nickel, copper, brass, gold and silver contacts, and the formula is compatible with electrical connector plastics and elastomers.

**11300004** 1 oz (28 g) Tube. **\$12.95**

## D. HARLEY-DAVIDSON® HIGH-PERFORMANCE SEALANT – GRAY

High-performance, room temperature vulcanized (RTV) silicone type liquid gasket is a low-odor, non-corrosive and non-conductive sensor-safe formula. Sealant allows high elongation when cured to absorb thermal and dynamic movement of the mating surfaces and is resistant to most chemicals and solvents. Temperature Range -76°F to 482°F (-60°C to 250°C). Approved for use as crankcase sealant on all Harley-Davidson® powertrains.

**99650-02** 1.9 oz (54 g) Tube. **\$13.95**

## E. PJ1® SUPER CLEANER

PJ1® Super Cleaner is a multi-application non-residue degreaser. The high-pressure blast of powerful solvents melts grease and grime away, dries quickly, and leaves no residue.

**99878-87T** 13 oz (368 g) Aerosol Can. **\$9.95**

## F. LOCTITE® PRO STRENGTH PARTS CLEANER

Loctite® Pro Strength Parts Cleaner aggressively penetrates, dissolves, and removes oil and grease from parts. Dries quickly with no residue. Contains no ozone-depleting chemicals (ODCs).

**94564-98** 19 oz (538 g) Aerosol Can. **\$8.95**

NEW



A. HARLEY AEROSOL LUBE



B. HARLEY LUBE



C. ELECTRICAL CONTACT LUBRICANT



D. HARLEY-DAVIDSON HIGH-PERFORMANCE SEALANT – GRAY



E. PJ1 SUPER CLEANER



F. LOCTITE PRO STRENGTH PARTS CLEANER

Notice: The prices appearing in this catalog are the manufacturer's suggested retail prices. Actual retail prices may vary.





**G. LOCTITE 271 THREADLOCKER AND SEALANT**



**H. LOCTITE 222MS THREADLOCKER AND SEALANT**



**I. LOCTITE 243 THREADLOCKER AND SEALANT**



**J. LOCTITE 262 THREADLOCKER AND SEALANT**



**K. LOCTITE THREADLOCKER STICK**



**L. LOCTITE SILVER GRADE ANTI-SEIZE**

**G. LOCTITE® 271™ THREADLOCKER AND SEALANT – RED**

High-prevailing strength threadlocker for heavy-duty applications. Especially well-suited for permanently locking studs and press fit assemblies. Adds 3000 PSI holding power on slip and press fit assemblies. Locks against vibration loosening. Requires extra effort or special tools for removal.

**99671-97** Red 6 ml Tube. **\$9.95**

**H. LOCTITE 222MS™ THREADLOCKER AND SEALANT – PURPLE**

A low strength product that is perfect for small fasteners, #2 to 1/4" diameter (6mm), long engagement length fasteners and components requiring occasional adjustment. This purple threadlocker is applied to threaded parts before assembly. Disassembly possible with hand tools. 222MS meets MIL-S-46163A.

**99811-97** Purple 6 ml Tube. **\$12.95**

**I. LOCTITE 243™ THREADLOCKER AND SEALANT – BLUE**

Worldwide replacement for 242® Threadlocker. A medium strength, general purpose thread locking adhesive, especially well-suited for fasteners between 1/4" and 3/4" diameter (6 to 20mm). Applied to threaded components before assembly. Blue 243 has controlled lubricity for accurate clamp loads. Disassembly possible with hand tools.

**99642-97** Blue 6 ml Tube. **\$10.95**

**11100005** Blue 50 ml Bottle. **\$40.95**

**J. LOCTITE 262 THREADLOCKER AND SEALANT**

Loctite® 262 is a permanent, high break-away strength product designed for securing fasteners 3/8" to 1" in diameter that must withstand heavy shock, vibration, or extreme chemical or environmental conditions. Localized heating and hand tools are required for disassembly.

**94759-99** Red 6 ml Tube. **\$13.95**

**11100006** Red 50 ml Bottle. **\$40.95**

**K. LOCTITE THREADLOCKER STICK**

Loctite QuickStix® Threadlocker is formulated to lock and seal threaded metal fasteners. The wax-like semi-solid won't drip like liquid formulas, and is conveniently packaged in a self-feeding stick applicator. Available in medium and high strength formulas.

**9 Gram Stick**

**11100003** Blue 248 – Medium Strength. **\$19.95**

**11100004** Red 268 – High Strength. **\$19.95**

**L. LOCTITE SILVER GRADE ANTI-SEIZE**

Heavy-duty metal-free anti-seize formulation protects metal parts from rust, corrosion, galling and seizing. Anti-Seize eases disassembly of slip fit, press fit and threaded joints, and provides outstanding lubrication to all metals including stainless steel, aluminum, and soft metals. Withstands temperatures up to 1600°F. Semi-solid stick for easy application.

**11100001** 20 g Stick Applicator. **\$14.95**

*Notice: The prices appearing in this catalog are the manufacturer's suggested retail prices. Actual retail prices may vary.*

# 866 GARAGE

## Sealants & Lubricants

### A. HYLOMAR® GASKET AND THREAD SEALANT

Recommended for holding gaskets in place during engine assembly.

**99653-85** 3.5 oz Tube. **\$24.95**

### B. ANTI-SEIZE LUBRICANT

An improved formulation to meet revision E of MIL-A-907E. It is a heavy-duty, high temperature anti-seize thread compound. It resists galling, corrosion and reduces wear in heavy pressure applications. This lubricant is based on a synthetic grease formulation containing graphite, aluminum, and copper and is sensor safe. It will not evaporate or harden when exposed to extreme heat or cold. Meets 1600°F temperature requirements.

**98960-97** 1 oz Tube. **\$4.95**

### C. LOCTITE® QUICKTITE® INSTANT ADHESIVE GEL

Loctite® QuickTite® Instant Adhesive Gel is a general-purpose instant adhesive for bonding metal, plastic, rubber, cork, cardboard, and leather. The precision-flow "squeeze grip" applicator allows pinpoint control of the exact amount and placement of the adhesive. The self-piercing, no-clog tip is spill-proof, and the locking cap prevents leaks and hardening.

**11100044** 0.14 oz Bottle. **\$7.95**

### D. LOCTITE FREEZE & RELEASE PENETRATING LUBE

Freeze & Release Penetrating Lube instantly chills seized and rusted bolts, nuts and studs down to -45°F (-43°C). The exceptional shock-freeze effect of this penetrating oil causes microscopic cracks in the layer of rust, allowing the lubricating ingredient to wick directly into the rust by capillary action. The rusted bolt assembly can be easily dismantled after allowing only 1-2 minutes penetration time. Aerosol nozzle and straw direct the spray for pinpoint application.

**11100002** 400 ml Aerosol Can. **\$19.95**

### E. DOW CORNING® MOLY 44 BRAKE PIN GREASE

The same grease applied at the factory to brake pins is now available as a replacement product to be used with all Harley-Davidson® Brake Pins on Floating Calipers (except '04-later XL models).

**94674-99** 2 cc Packet. **\$3.95**

### F. LOCTITE 565 THREAD SEALANT

Formulated specifically for metal, tapered, pipe thread fittings, PST 565 cures rapidly to provide immediate low pressure sealing. Its controlled lubricity prevents galling, and it protects mated threaded areas from rust and corrosion. 565 can be used on fittings up to 2" (50mm) in diameter and has a temperature range of -65°F to 300°F (-54°C to 149°C). Disassembly possible with hand tools.

**99818-97** 6 ml Tube. **\$6.95**



A. HYLOMAR GASKET AND  
THREAD SEALANT



B. ANTI-SEIZE LUBRICANT



C. LOCTITE QUICKTITE INSTANT  
ADHESIVE GEL



D. LOCTITE FREEZE & RELEASE  
PENETRATING LUBE



E. DOW CORNING MOLY 44 BRAKE PIN GREASE



F. LOCTITE 565 THREAD SEALANT

*Notice: The prices appearing in this catalog are the manufacturer's suggested retail prices. Actual retail prices may vary.*



### H. PAINTS

Touch-up paint is available in handy 1/2 oz applicator bottles for all late model Harley-Davidson® motorcycles including CVO™ models. Aerosol and quart containers are also available. See your Authorized Harley-Davidson Dealer for a complete listing of paint.

NOTE: Quart containers of Harley-Davidson Acrylic Urethane paint and urethane activator material are designed for application only by professional, trained personnel using proper equipment under controlled conditions, and they are not intended for sale to the general public.

#### Black Texture

'95-later Engine and Transmission.

<b>98605BF*</b>	Touch-Up Pen.	<b>\$11.95</b>
<b>98600BF*</b>	Touch-Up Bottle.	<b>\$11.95</b>
<b>98606BF</b>	Aerosol.	<b>\$23.95</b>

#### Silver Bead Blast

'98-later Engine and Transmission.

<b>98600BY*</b>	Touch-Up Bottle.	<b>\$11.95</b>
<b>98606BY</b>	Aerosol.	<b>\$23.95</b>

#### Clear Coat

Used to fill in clear coating over chips and surface scratches.

<b>98600EK*</b>	Touch-Up Bottle.	<b>\$11.95</b>
<b>98606EK</b>	Aerosol.	<b>\$23.95</b>
<b>98628EK</b>	Quart. Two-Part Urethane.	<b>\$84.95</b>
<b>99825-02</b>	Urethane Activator.	<b>\$55.95</b>

#### Black Leather Touch-Up Pens

A convenient way to fix scratches, scuffed and worn pouches, saddlebags, seats and other leather products. Just touch-up the damaged area, wipe off excess, let dry and then buff with a soft cloth to blend color.

<b>98605AX*</b>		<b>\$11.95</b>
-----------------	--	----------------

#### Black Frame Paint Touch-up Pen

Dispensed from an easy-to-use paint pen, this paint is an easy way to touch-up minor nicks and scratches.

<b>93936*</b>		<b>\$5.95</b>
---------------	--	---------------

\*NOTE: Price shown is price per each bottle or pen. There are two bottles or pens per package.



### H. PAINTS

Notice: The prices appearing in this catalog are the manufacturer's suggested retail prices. Actual retail prices may vary.

## H-D® AGM\* ORIGINAL EQUIPMENT BATTERIES\*\*

Genuine H-D® Batteries offer the latest technology for higher cold cranking amps, long life and improved rechargeability. Featuring the latest AGM technology and great Harley-Davidson graphics, these batteries are durable, long-lasting and trouble-free. Made in the U.S.A.

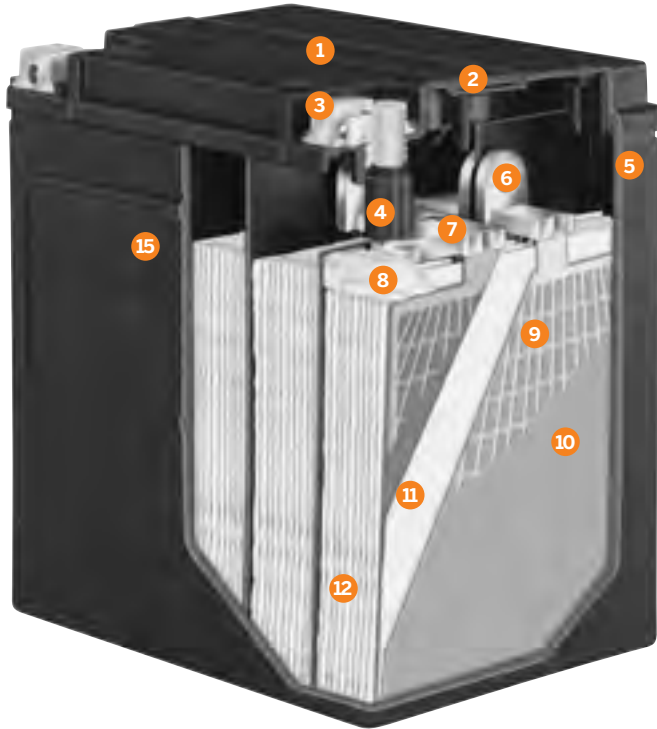

Motorcycle batteries built and rigorously tested to Harley-Davidson's exacting requirements. H-D® AGM battery ratings are determined by the strict regulations and testing of the Battery Council International.



**WARNING:** Battery posts, terminals and related accessories contain lead compounds, chemicals known to the State of California to cause cancer and birth defects.

- 1 Completely sealed, valve regulated maintenance-free design eliminates acid spills and corrosion damage.
- 2 Re-engineered vent system is specially designed to minimize leakage.
- 3 Exclusive molded terminal design increases strength and durability.
- 4 Unique positive post bushing resists vibration damage and retards acid leaks and corrosion.
- 5 Heat sealed cover prevents electrolyte leakage and improves reliability.
- 6 Larger diameter through-partition welds direct more power to the starting motor.
- 7 Heavy top lead improves plate-to-lug adhesion for vibration resistance and long life.
- 8 Plates are lock-bonded together, reducing vibration damage for longer life.

- 9 Exclusive calcium/calcium alloy grids provide highest cranking amps and lowest self-discharge. Full frame, power path design directs more power to the terminals for quick, sure starts.
- 10 High density oxide provides maximum power-per-pound or dependable "high cycling" service.
- 11 Tear-resistant AGM\* separators protect plates, ensuring long life.
- 12 Exclusive demineralized electrolyte improves service life. Metered addition of electrolyte means no excess acid.
- 13 Positive terminal protector (not shown) protects against short circuits and sparks.
- 14 Stainless steel terminal bolts (not shown) won't rust or corrode.
- 15 Distinguished Harley-Davidson Bar & Shield is molded into case, for quick, confident recognition.

\*Absorbed Glass Mat

### ORIGINAL EQUIPMENT & REPLACEMENT BATTERIES

#### H-D AGM BATTERIES

**65989-97C** Dual (Top and Side) Terminal Design. **\$129.95**  
Fits '97-'03 XL models, '97-later Dyna® and Softail® and '07-later VRSC™ (except '07 VRSCR) models. Also fits Buell® S1, S3/T, M2 and X1 models.

**66010-97C** Dual (Top and Side) Terminal Design. **\$170.95**  
Fits '97-later Touring and '09-later Trike models.

**65958-04A** **\$114.95**  
Fits '15-later XG, '04-later XL and '08-'12 XR models. Also fits Buell 1125R/CR models.

**65948-00A** **\$115.95**  
Fits '02-'06 VRSC and '07 VRSCR models. Also fits Buell XB and Blast models.

**65991-82B** **\$130.95**  
Fits '73-'94 electric start FX and FXR, '77-'78 XLCR, '79-'96 XL, '84-'90 Softail and '99-'00 FXR models. Replaces P/N 65991-82A and 65991-75C. Also fits Buell S2/T Thunderbolt® models.

**66010-82B** **\$145.95**  
Fits '80-'96 FLHR, FLHT and FLT Touring models.

**65989-90B** Fits '91-'96 Dyna and Softail models. **\$130.95**

NOTE: Battery dimensions of Harley-Davidson AGM Batteries P/N 65989-97C, 65989-90B and 65991-82B may not allow use of accessory side covers on XL and Dyna models.

#### CONVENTIONAL BATTERIES\*\* (not shown)

**66006-29F** 6V. **\$70.95**  
Fits '64-earlier FL and '63-earlier GE models.

**66006-70** 12V. **\$55.95**  
Fits '70-later kickstart FX and XLCH models.

#### HEAVY-DUTY HIGH-CRANKING PREMIUM BATTERY\*\*

**66007-84** 12V. **\$140.95**  
Fits '65-'84 FL, FLH, '67-'78 XLH (except '77-'78 XLCR), and '64-later GE models.

Notice: The prices appearing in this catalog are the manufacturer's suggested retail prices. Actual retail prices may vary.



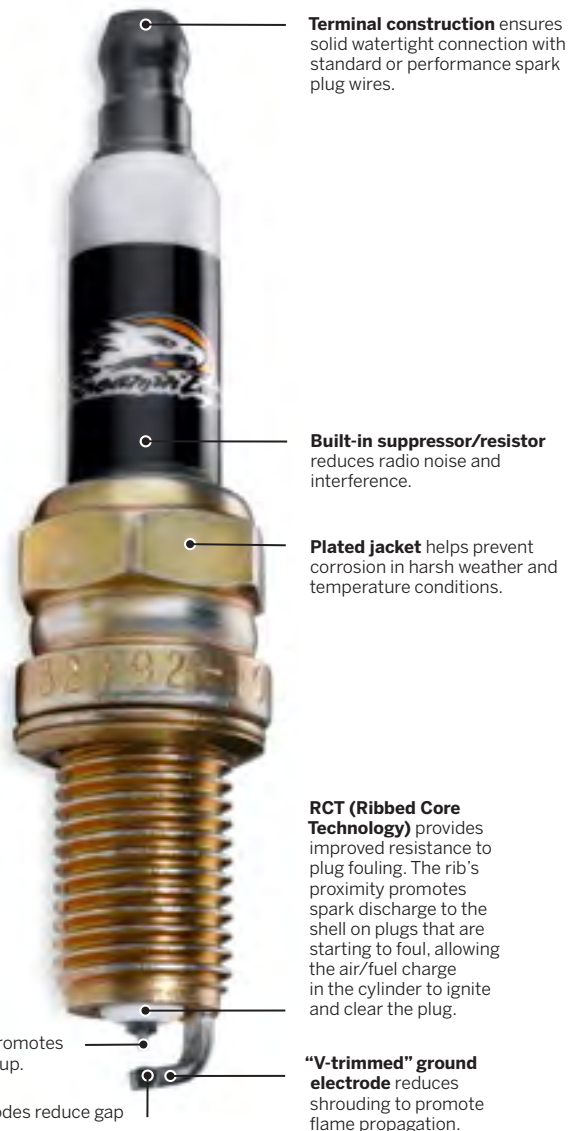

**Terminal construction** ensures solid watertight connection with standard or performance spark plug wires.

**Built-in suppressor/resistor** reduces radio noise and interference.

**Plated jacket** helps prevent corrosion in harsh weather and temperature conditions.

**RCT (Ribbed Core Technology)** provides improved resistance to plug fouling. The rib's proximity promotes spark discharge to the shell on plugs that are starting to foul, allowing the air/fuel charge in the cylinder to ignite and clear the plug.

**Fine Wire Center Electrode** promotes ignitability and enhances start up.

**Platinum pads** on both electrodes reduce gap erosion for longer plug life.

**"V-trimmed" ground electrode** reduces shrouding to promote flame propagation.

### A. SCREAMIN' EAGLE ST PERFORMANCE SPARK PLUGS

### A. SCREAMIN' EAGLE® ST PERFORMANCE SPARK PLUGS

Screamin' Eagle® ST Spark Plugs feature double platinum coating for superior erosion resistance and extended life. The "V" trimmed ground electrode reduces shrouding of the flame front to promote flame propagation, and the fine wire center electrode enhances start ups and ignitability. Screamin' Eagle ST Plugs feature Ribbed Core Technology (RCT) that provides resistance to fouling, and are designed with Original Equipment-style noise suppression to prevent electrical interference with radios and CB communication equipment. Works great in racing applications where rich air/fuel conditions are required. Unique style with Screamin' Eagle logo. Sold in pairs.

#### High Compression Applications

These plugs are designed for high performance applications involving modifications in high-flow air cleaners, camshafts, exhaust, performance heads, ignition components, higher compression ratios above Original Equipment configurations or engines specific for racing applications.

**32186-10** **\$19.95**  
Fits '99-later Twin Cam-equipped models, '86-later XL and XR, and Evolution® 1340 models equipped with Screamin' Eagle Performance Cylinder Heads.

**32188-10** **\$19.95**  
Fits '84-'99 Evolution 1340-equipped models, '75-'81 Shovelhead 74 and 80CI, and '83-'84 XR1000 models.

#### Stock Compression Applications

Designed for modified engines including performance carburetors, high-flow air cleaners, camshafts, exhaust systems and ignition systems in conjunction with stock compression ratios.

**32189-10** **\$19.95**  
Fits '84-'99 Evolution 1340-equipped models, '75-'81 Shovelhead 74 and 80CI models.

**32192-10** **\$19.95**  
Fits '99-later Twin Cam-equipped models, and '86-later Evolution Sportster® 883, 1100 and 1200 models.

### B. HARLEY-DAVIDSON GOLD SPARK PLUGS

A special thread and shell coating ensures quick and easy removal from aluminum heads and resists corrosion. A gold palladium insert extends life and improves resistance to corrosion. The tapered tip provides better spark exposure to air/fuel mixture and allows the mixture to flow more easily through gap area for maximum combustibility. Fouling resistance is improved with smaller diameter center electrode wire and insulator tip. Plus, a copper-cored ground electrode runs cooler for extended life.

**32365-04** (6R12G) **\$6.95 each**  
Fits '86-later XL and '99-later Twin Cam-equipped models or use in place of No. 6R12.

**32367-04** (5R6AG) **\$6.95 each**  
Fits late '78-'84 Shovelhead and '84-'99 Evolution 1340-equipped models or use in place of Nos. 5R6A and 5RL.

**32331-05** (10R12AG) **\$6.95 each**  
Fits '02-later VRSC™ models.

**27794-08** (10R12X) **\$5.95 each**  
Fits '08-'12 XR models.

### C. HARLEY-DAVIDSON ORIGINAL EQUIPMENT SPARK PLUGS

**32335-04** (10R12A) **\$4.95 each**  
Fits '02-later VRSC models.

**31600012** (RG6HCC) **\$3.95 each**  
Fits '15-later XG models.

**32342-04** (5R6A) **\$3.95 each**  
Fits late '78-'84 Shovelhead and '84-'99 Evolution 1340-equipped models.

**32362-04** (6R12) **\$3.95 each**  
Fits '86-later Evolution-equipped XL models and '99-later Twin Cam-equipped models.

**32338-04** (4R5) Fits '71-'85 Iron Sportster. **\$3.95 each**

**32336-04** (4R) **\$3.95 each**  
Fits '54-'56 KH, '57-'70 XL-900, '71-'85 Iron Sportster and '48-'74 FLH/FX.

**32337-04** (3-4) Fits '48-'74 FLH/FX. **\$3.95 each**



B. HARLEY-DAVIDSON GOLD SPARK PLUGS



C. HARLEY-DAVIDSON ORIGINAL EQUIPMENT SPARK PLUGS

Notice: The prices appearing in this catalog are the manufacturer's suggested retail prices. Actual retail prices may vary.

# 870 GARAGE

## Air Filters

### A. HARLEY-DAVIDSON® ORIGINAL EQUIPMENT AIR FILTER ELEMENTS

Late-model pleated paper type elements with aluminum back plates.

<b>29400078</b>	Fits '15-later XG models	<b>\$25.95</b>
<b>29331-04</b>	Fits '04-'13 XL models (except XL1200V).	<b>\$31.95</b>
<b>29400015</b>	Fits '14-later XL models and '12-later XL1200V.	<b>\$26.95</b>
<b>29377-08</b>	Fits '08-'12 XR models.	<b>\$26.95</b>
<b>29437-01A</b>	Fits '02-later VRSC™ models.	<b>\$44.95</b>
<b>29400042</b>	Fits '99-'06 carbureted Twin Cam equipped models, '01-later EFI Softail® (except '08-'11 FLSTSB, '11-later FXS, '12-later FLS and '13-later FXDB) and '02-'07 EFI Touring and Dyna® models.	<b>\$26.95</b>
<b>29633-08</b>	Fits '08-'13 Touring and Trike models.	<b>\$26.95</b>
<b>29400045</b>	Fits '14-later Touring and Trike models	<b>\$19.95</b>
<b>29191-08</b>	Fits '08-later Dyna models (except '13-later FXDB).	<b>\$26.95</b>
<b>29314-08</b>	Fits '08-'11 FLSTSB, '11-later FXS, '12-later FLS and '13 FXDB models.	<b>\$26.95</b>
<b>29509-06</b>	Fits '06-'10 FLHTCUSE models.	<b>\$26.95</b>
<b>29462-99</b>	Fits '99-'01 EFI Twin Cam models (except '01 Softail).	<b>\$26.95</b>
<b>29330-96</b>	Fits '96-'00 Evolution® 1340 models with carburetors.	<b>\$26.95</b>
<b>29291-95</b>	Fits '95-'99 Evolution 1340 models with electronic fuel injection (EFI).	<b>\$26.95</b>
<b>29259-91A</b>	Fits '91-'95 Evolution 1340 FLT, FLHT, FLHR, Softail, Dyna and FXR models.	<b>\$26.95</b>
<b>29331-96</b>	Fits '88-'03 Evolution XL models.	<b>\$26.95</b>
<b>29259-89</b>	Fits '90 Evolution 1340 models.	<b>\$19.95</b>
<b>29259-86</b>	Fits '86-'89 Evolution 1340 models.	<b>\$19.95</b>
<b>29036-72</b>	Fits '66-early '73 and '83-'85 XL, '71-early '75 FX and '67-early '75 FLH models.	<b>\$19.95</b>
<b>29325-95A</b>	Fits '95-'03 Evolution XL and 1340 models. (International models only. See your Dealer.)	<b>\$26.95</b>



A. HARLEY-DAVIDSON ORIGINAL EQUIPMENT AIR FILTER ELEMENTS



A. XR1200 AIR FILTER ELEMENT



A. VRSC AIR FILTER ELEMENT



A. FOAM STYLE AIR FILTER ELEMENTS

Notice: The prices appearing in this catalog are the manufacturer's suggested retail prices. Actual retail prices may vary.





**B. SCREAMIN' EAGLE HIGH-FLO K&N AIR FILTER ELEMENT**

**B. SCREAMIN' EAGLE® HIGH-FLO K&N® AIR FILTER ELEMENT**

K&N® replacement air filters are engineered to improve airflow for increased horsepower and quicker acceleration. K&N filters provide excellent filtration, and because they are washable and reusable, you can clean the filter whenever conditions demand. Designed as direct replacements for specified fitments.

NOTE: These washable and rechargeable filters use a special coating to help filter fine particles from the incoming air. With time, the oil in the filter will dissipate and the element will begin to turn gray. Clean the surface and renew the original red color with an application of K&N Air Filter Care products.

**1. 29400020** Stage I—Multi-fit. **\$59.95**  
Fits '07-later XL, '99-'07 Dyna®, '00-later Softail® and '99-'07 Touring models equipped with Stage I Air Cleaner Kit P/N 29000009, 29000019A, 29773-02C or 29440-99D. Replacement for P/N 29442-99E.

**2. 29400021** Stage I—Dyna. **\$59.95**  
Fits '08-later Dyna models equipped with Stage I Air Cleaner Kit P/N 29406-08. Replacement for P/N 29385-08.

**3. 29400019** Stage I—Touring. **\$59.95**  
Fits '08-later Touring and Trike models equipped with Stage I Air Cleaner Kit P/N 29260-08. Replacement for P/N 29244-08.

**4. 29400065** Extreme Billet. **\$59.95**  
Fits '15-later XG and '08-later Touring and Trike models equipped with Extreme Billet Agitator and Chisel Air Cleaner Kits.

**4. 29400118** Extreme Billet. **\$59.95**  
Fits '07-later XL, '08-later Dyna and Softail and models equipped with Extreme Billet Chisel and Agitator Air Cleaner Kits.

**5. 29400109** Burst Collection. **\$59.95**  
Fits models equipped with Burst Collection Air Cleaner Kits.

**6. 29400026** Stage I—XL. **\$59.95**  
Fits '88-later XL models equipped with High-Flow Air Cleaner Kit P/N 29042-04C or 29066-03B. Replacement for P/N 29044-04B.

**7. 29400022A** Ventilator—Multi-fit. **\$59.95**  
Fits models equipped with Ventilator and Extreme Billet Ventilator Performance Air Cleaner Kits. Replacement for P/N 29670-09.

**8. 29424-05A** Heavy Breather—Multi-fit. **\$89.95**  
Fits '91-later XL, '99-later Dyna, '00-later Softail and '99-'07 Touring models equipped with Heavy Breather Kit P/N 29098-09, 29299-08, 29080-09 or 29264-08.

**8. 29702-08A** Heavy Breather—Touring. **\$89.95**  
Fits models equipped with Heavy Breather Kit P/N 29006-09B, 29253-08B, 29000065 or 29400105.

**9. 28714-10** Heavy Breather—Compact. **\$89.95**  
Fits '08-later Touring and Trike models equipped with Compact Heavy Breather Kit P/N 28716-10A.

**10. 29400141** Heavy Breather Elite. **\$99.95**  
Fits models equipped with Screamin' Eagle Heavy Breather Elite Performance Air Cleaner Kit P/N 29400172 and 29400173.

**K&N AIR FILTER CARE PRODUCTS**

Clean and restore the original performance of K&N air filter elements. The washable and rechargeable filters use a special coating to help filter fine particles from the incoming air. With time, the oil in the filter will dissipate and the element will begin to turn gray. Clean the surface and renew the original red color with an application of K&N Air Filter Care products.

**C. K&N AIR FILTER CARE SERVICE KIT**

**99850-92T** **\$14.95**  
Complete kit to clean and re-oil K&N-type air filters. Includes one 12 oz bottle Air Filter Cleaner and one aerosol Air Filter Oil.

**D. K&N AIR FILTER OIL**

**99882-88T** 12 oz Aerosol. **\$9.95**

**E. K&N POWER KLEEN AIR FILTER CLEANER**

**93600004** 32 fl oz with Sprayer. **\$11.95**



**C. K&N AIR FILTER CARE SERVICE KIT**



**D. K&N AIR FILTER OIL**

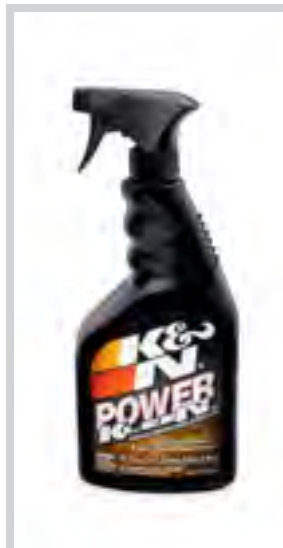

**E. K&N POWER KLEEN AIR FILTER CLEANER**

Notice: The prices appearing in this catalog are the manufacturer's suggested retail prices. Actual retail prices may vary.

# 872 GARAGE

## Oil Filters

### A. SUPERPREMIUM5™ OIL FILTERS – 5 MICRON

Utilizing advances in synthetic media technology, the SuperPremium5™ Oil Filters are Tested-Certified to provide filtration to retain dust, soot and other solid matter with low internal pressure drop. Filter also includes internal pressure relief and anti-drain back valves.

Fits '99-later Twin Cam and Evolution® models (except '08-'13 XR) and can be used as an upgrade for any motorcycle that requires Oil Filter P/N 63796-77A, 63805-80A, 63812-90 or 63813-90.

**63798-99A** Chrome. **\$14.95**

**63731-99A** Black. **\$10.95**

#### SuperPremium10 Oil Filter – 10 Micron (not shown)

Fits '02-later VRSC™ models.

**63793-01K** Black. **\$9.95**

### B. GENUINE HARLEY-DAVIDSON® OIL FILTERS

Filter features cured resin impregnated paper which removes harmful foreign particles from the oil. End caps and thermal setting adhesive provide positive seals, preventing bypassing of contaminant-laden oil.

#### Spin-On

Fits all XB and Buell models.

**63806-00Y** Black. **\$7.95**

Fits '15-later XG models.

**62700045** **\$7.95**

Fits '91-98 Dyna® models.

**63812-90** Black, Extra Long. **\$8.95**

**63813-90** Chrome, Extra Long. **\$12.95**

Fits late '82-'84 FLH-80 Classics, '82-'86 FXWG, FXSB, FXEF and '79-early '84 XL models.

**63782-80** Chrome, Short. **\$11.95**

**63810-80A** Black, Short. **\$8.95**

Fits '80-'98 FLT, FLHT, FLHR, '82-'94 FXR, '84-'98 Softail®, '84-'95 FXRP, FLHTP, late '84-later XL and '08-'13 XR models.

**63796-77A** Chrome, Long. **\$10.95**

**63805-80A** Black, Long. **\$8.95**

#### CLASSIC MOTOR PARTS OIL FILTERS (not shown)

Quality filters at a great price. Replaces P/N 63840-53 or 63835-87T with a cartridge type filter and spring.

**62700055** In Tank Oil Filter. **\$10.95**

#### DEFINITIVES FILTER ELEMENT (not shown)

TESTED-CERTIFIED Synthetic Filter media provides nominal 5 micron filtration. Increased retained capacity for dust, soot and other solid matter. Low internal pressure drop.

**63834-07** **\$13.95**

Fits models equipped with DEFINITIVES Filtration System.

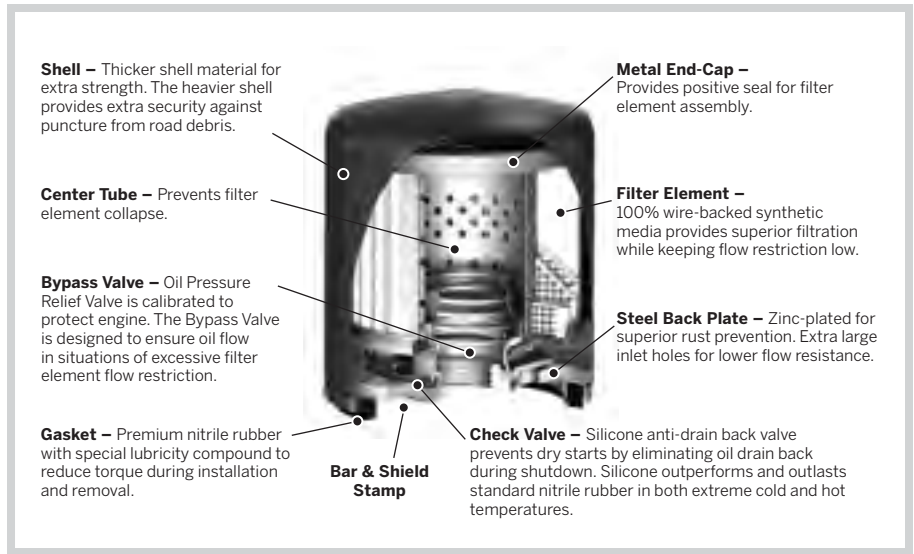

A. SUPERPREMIUM5 OIL FILTERS



A. SUPERPREMIUM5 OIL FILTERS



B. GENUINE HARLEY-DAVIDSON OIL FILTERS

Notice: The prices appearing in this catalog are the manufacturer's suggested retail prices. Actual retail prices may vary.



### C. H-D® ORIGINAL EQUIPMENT BRAKE PADS

#### Front

<b>42897-08</b>	Front. Fits '08-later VRSC™ models.	<b>\$49.95</b>
<b>42897-06A</b>	Front. Fits '06-'07 VRSC models.	<b>\$49.95</b>
<b>41300004</b>	Front. Fits '14-later XL models.	<b>\$59.95</b>
<b>42831-04A</b>	Front. Fits '04-'13 XL models.	<b>\$48.95</b>
<b>42739-08</b>	Front. Fits '08-'13 XR models.	<b>\$51.95</b>
<b>46363-11</b>	Front. Fits '12-later Dyna® and '11-'14 Softail® models.	<b>\$56.95</b>
<b>41300102</b>	Front. Fits '15-later Softail models.	<b>\$59.95</b>
<b>44082-08</b>	Front. Fits '08-'11 Dyna and '08-'10 Softail (except Springer™) models.	<b>\$45.95</b>
<b>41854-08</b>	Front. Fits '08-later Touring and '08-'13 Trike models.	<b>\$51.95</b>
<b>44063-83C</b>	Front. Fits '84-'99 XL, '84-'86 FX, '84-'99 Softail, '84-'99 FXR, '84-'99 FLT/ FLHT/ FLHR, '91-'99 Dyna, and '00-later FXSTS and FLSTS models.	<b>\$53.95</b>
<b>41300027</b>	Front. Fits '14-later Trike models.	<b>\$53.95</b>

#### Front & Rear

<b>41300072</b>	Front/Rear. Fits '15-later XG models	<b>\$39.95</b>
<b>44082-00D</b>	Front/Rear. Fits front and rear brakes on '00-'03 XL, '00-'05 VRSC and '00-'07 Dyna, Softail and Touring models. (except front brakes on FXSTS and FLSTS Springer). Does not fit '06-'07 rear brakes on FXSTS, FXST, FXSTB, and FLSTFSE2 models.	<b>\$53.95</b>
<b>43395-80A</b>	Front/Rear. Fits '80-'83 FLT/FLHT front and '79-'81 XL rear.	<b>\$43.95</b>
<b>44135-74A</b>	Front/Rear. Fits front and rear '73-early '78 FX, '72-early '78 FLH and '73 XLH/XLCH (front).	<b>\$51.95</b>

#### Rear

<b>42850-06B</b>	Rear. Fits '06-later VRSC models.	<b>\$46.95</b>
<b>41300053</b>	Rear. Fits '14-later XL models.	<b>\$53.95</b>
<b>42029-07</b>	Rear. Fits '07-'13 XL models.	<b>\$42.95</b>
<b>42836-04A</b>	Rear. Fits '04-'06 XL models.	<b>\$42.95</b>
<b>42310-08</b>	Rear. Fits '08-'13 XR models.	<b>\$42.95</b>
<b>42298-08</b>	Rear. Fits '08-later Dyna and Softail models.	<b>\$53.95</b>
<b>46721-06A</b>	Rear. Fits '06-'07 FXST and FXSTB; '06 FLSTFSE2 and FXSTS; '07 FLSTF, FXSTC, and FXSTSSE.	<b>\$53.95</b>
<b>44209-87C</b>	Rear. Fits late '87-'99 XL, FXR, Softail and '91-'99 Dyna models.	<b>\$65.95</b>
<b>41852-08B</b>	Rear. Fits '08-later Touring models. Does not fit Trike models.	<b>\$57.95</b>
<b>43957-86E</b>	Rear. Fits '86-'99 FLT, FLHT, FLHS and FLHR models.	<b>\$59.95</b>
<b>43957-80A</b>	Rear. Fits '80-'85 FLT, FLHT, and '81-'84 FLH models.	<b>\$94.95</b>
<b>41300033</b>	Rear. Fits '14-later Trike models.	<b>\$92.95</b>
<b>83911-09B</b>	Rear. Fits '09-'13 Trike models.	<b>\$92.95</b>



C. H-D ORIGINAL EQUIPMENT BRAKE PADS

Notice: The prices appearing in this catalog are the manufacturer's suggested retail prices. Actual retail prices may vary.

# 874 GARAGE

Dunlop® Tires

## **DUNLOP · HARLEY-DAVIDSON** **T I R E S E R I E S**

Since 1984, Dunlop Tires has provided Original Equipment and service replacement tires for Harley-Davidson® Motorcycles. Dunlop is recognized as the world-leader in motorcycle tire design, engineering and manufacturing excellence.

Please refer to the tables on page 876-882 for proper fitment.



Blackwall

Slim Whitewall



Blackwall

Slim Whitewall

Wide Whitewall

Engraved Wide Whitewall

### D407/D408 TOURING

The D407/D408 tire is constructed for '09-later FL Touring, select Softail® and specific Custom Vehicle Operations™ (CVO™) models and is available exclusively through Harley-Davidson Dealers. The FL Touring rear tires feature Dunlop's advanced MT (Multi-Tread) technology.

- Tire features bold "Harley-Davidson" script on the sidewall.
- MT Multi-Tread rear tire incorporates a tough tread compound in the center that runs cooler to provide stability, excellent traction under braking and long life and to each side is a section of lateral-grip compound that enhances traction at higher lean angles for great grip while cornering.
- Reinforced multi-layer tire carcass gives the tire strength for long life and provides stability at highway speeds and maximum lean angles.
- Bold, angled lateral grooves in the tread pattern evacuate water from the contact patch on wet roads.
- The D407/408 is available in blackwall, slim white and wide-white sidewall styles.

### D402 TOURING

Built with a three-ply polyester casing with two fiberglass belts, the D402 offers greater load-carrying capacity and stability.

- Computer-optimized tread profile with offset center groove improves rider confidence over rain grooves and steel-grated bridges, while reducing cupping for even wear.
- The D402 is available in blackwall, slim whitewall, wide whitewall and engraved wide whitewall styles.



Blackwall

Wide Whitewall

Blackwall

Blackwall

### D401 CRUISER

An advanced tread pattern and specifically formulated compound deliver outstanding grip in wet or dry weather and provide long tire life.

- D401 tires use bias or bias-belted construction and incorporate a computer-optimized tread profile to reduce cupping for even wear.

### GT502 PERFORMANCE

GT502 Performance Tires feature an optimized profile, contact patch and compound for superior grip in dry conditions, with solid grip during wet weather riding conditions.

### SIGNATURE SERIES

Signature Series Tires are packed with features for responsive handling and confident cornering to tighten the connection between you and the road.





# MICHELIN

## GARAGE 875

Michelin® Tires

Since 1889, Michelin has been a leader in the tire industry. From introducing the world's first radial tire in 1946, to being the first to use radial motorcycle tires in race competition, Michelin has demonstrated its dedication to producing some of the world's most innovative tire products. A leader in racing technology, Michelin researches, tests and develops tire solutions in the most demanding form of racing competition. Harley-Davidson motorcycle riders benefit from that technology, as Michelin transfers track technology into Harley-Davidson® motorcycle riding confidence and performance.

*Please refer to the tables on page 876-882 for proper fitment.*

### MICHELIN SCORCHER® TIRES

**Made exclusively for Harley-Davidson**

The Scorchers are the first Michelin – Harley-Davidson co-branded tire, with a bold “Harley-Davidson” script on the sidewall. Featuring an exceptional combination of durability, comfort and handling. The Scorchers “11” and Scorchers “31” are factory-installed on many models, and can be installed as a replacement tire on other specified models.



#### MICHELIN *Scorchers* 31

**Remarkable Grip:**

Innovative rubber compounds, incorporating know-how derived from Michelin's decades of road-racing experience, provide remarkable grip on both wet and dry roads.

**Exceptional Comfort and Handling:**

The supple casing design and profile of MICHELIN® Scorchers® “31” tires promote rock-solid handling on winding roads.

**Long Mileage:**

Michelin carbon black-enriched rubber compounds promote excellent durability without compromising performance.

#### MICHELIN *Scorchers* 11

**Outstanding Grip:**

Semi-slick tread pattern maximizes the contact patch for excellent adhesion on dry roads. Optimized tread groove design efficiently evacuates water for dependable wet grip.

**Excellent Tread Life:**

Derived from Michelin's championship-winning racing tires, newly developed rubber compounds combine durability and high performance.

**Precise Handling:**

The latest generation of Michelin radial technology allows for easy maneuverability and impressive agility.

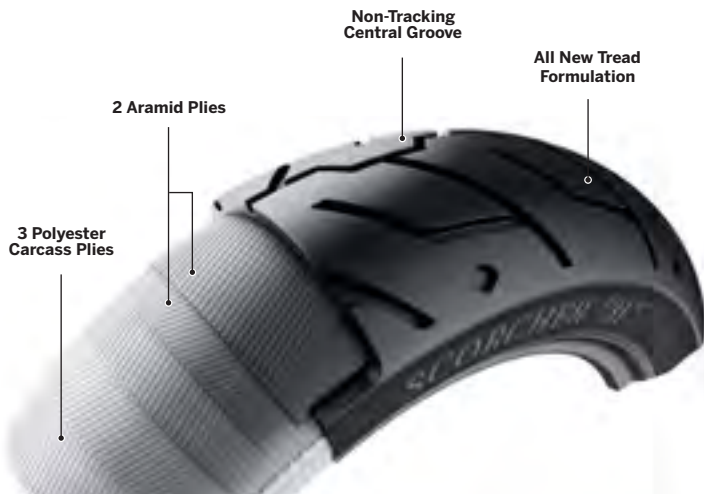

- **Rear Tire Architecture:**  
Provides stability, great handling, plus comfort.
- **3 Polyester Carcass Plies:**  
Strong and supple casing for comfort on long rides.
- **2 Aramid Belt Plies:**  
Maintains consistent contact patch for a long and even wear life.

# 876 GARAGE

Tires – Sportster® Models

## ORIGINAL EQUIPMENT AND RECOMMENDED REPLACEMENT TIRES

Model Fitment	Stock or Optional Fitment	Tread	Size	Rim Size in Inches	PSI	Sidewall Style	Part Number	Price
<b>SPORTSTER® – FRONT</b>								
<b>DUNLOP® HARLEY-DAVIDSON® PERFORMANCE TIRES</b>								
'96-'03 XL1200 Sport	Stock							
'04-later XL (except XL Custom, XL1200T, XL1200X, XL1200V, XR1200/X or '11-later XL883L) Installation requires installation of matching GT502 Rear Tire P/N 40555-04A	Optional	GT502F	100/90-19	2.15 x 19	30	BW	<b>40554-04A</b>	<b>\$165.95</b>
'96-'10 XL883C	Optional	GT502F	80/90-21	2.15 x 21	30	BW	<b>43117-09</b>	<b>\$169.95</b>
'96-'10 XL1200C	Optional							
<b>DUNLOP® HARLEY-DAVIDSON® TIRE SERIES</b>								
'10-later XL1200X	Stock on MY '10	D402F	MT90B16	3.00 x 16	30	BW	<b>43022-91A</b>	<b>\$174.95</b>
'08-'13 XR1200/X	Stock on MY '08-'11	D209F RP	120/70ZR18	3.50 x 18	36	BW	<b>43229-08</b>	<b>\$238.95</b>
'04-later XL (except XL Custom, XL1200T, XL1200X, XL1200V, XR1200/X or '11-later XL883L)	(BW)	D401F	100/90-19	2.15 x 19	30	WWW	<b>55193-10</b>	<b>\$202.95</b>
	Stock on MY '04-'10					BW	<b>43112-91A</b>	<b>\$154.95</b>
'91-'09 XL883, XL883R, XL883 Hugger (except XL Custom)	Stock	D401F	100/90-19	2.15 x 19	30	BW	<b>43112-91A</b>	<b>\$154.95</b>
'88-'03 XL1200 (except XL Custom, XL Sport)	Stock							
'83-'84 XR1000	Stock							
'81-'90 XL (except XR1000, XL1200)	Stock	D401F	90/90-19	2.15 x 19	30	BW	<b>40567-90A</b>	<b>\$158.95</b>
'96-'10 XL883C / XL1200C	Stock	D402F	MH90-21	2.15 x 21	30	BW	<b>43104-93A</b>	<b>\$145.95</b>
'12-later XL1200V	Stock	D402F	MH90-21	2.15 x 21	30	MWW	<b>43100004</b>	<b>\$185.95</b>
<b>MICHELIN® HARLEY-DAVIDSON® TIRE SERIES</b>								
'11-later XL1200C	Stock on MY '11-later	SCORCHER 31	130/90B16	3.00 x 16	36	BW	<b>55035-11A</b>	<b>\$199.95</b>
'10-later XL1200X		SCORCHER 11	120/70ZR18	3.50 x 18	30	BW	<b>40879-11A</b>	<b>\$239.95</b>
'08-'13 XR1200/X	Stock on MY '12-later	SCORCHER 31	100/90B19	2.15 x 19	30	BW	<b>43258-07B</b>	<b>\$165.95</b>
'04-later XL (except XL Custom, XL1200T, XL1200X, XL1200V, XR1200/X or '11-later XL883L)	Stock on MY '11-later							
'12-later XL1200V	Optional	SCORCHER 31	80/90-21	2.15 x 21	30	BW	<b>41036-12</b>	<b>\$169.95</b>
'04-'10 XL 883C								
'04-'10 XL 1200C								
'14-later XL1200T	Stock	Scorcher 11T	120/70ZR18	3.50 x 18	36	BW	<b>43100021</b>	<b>\$224.95</b>
<b>SPORTSTER – REAR</b>								
<b>DUNLOP® HARLEY-DAVIDSON® PERFORMANCE TIRES</b>								
'04-later XL (except XL1200T, XL1200X, XL1200V, XR1200/X, '11-later XL883L or '11-later XL1200C) Installation on models with 19" front wheel requires installation of matching GT502F Front Tire P/N 40554-04A	Optional	GT502	150/80B16	3.00 x 16	36/40	BW	<b>40555-04A</b>	<b>\$234.95</b>
'96-'03 XL1200 Sport	Stock	GT502	130/90B16	3.00 x 16	36/40	BW	<b>40556-06A</b>	<b>\$218.95</b>
<b>DUNLOP® HARLEY-DAVIDSON® TIRE SERIES</b>								
'04-later XL (except XR1200/X, XL1200V, XL1200T, '11-later XL883L or '11-later XL1200C)	Stock MY '04-'10	D401	150/80B16	3.00 x 16	36/40	BW	<b>43264-02</b>	<b>\$203.95</b>
'04-later XL (except XL1200X, XL1200V, XR1200/X, XL1200T, '11-later XL883L or '11-later XL1200C)	Optional	D401	150/80B16	3.00 x 16	36/40	WWW	<b>55192-10</b>	<b>\$272.95</b>
'12-later XL1200V	Stock	D401	150/80B16	3.00 x 16	40	MWW	<b>43200007</b>	<b>\$252.95</b>
'81-'03 XL (except XL1200 Sport)	Stock	D401	130/90B16	3.00 x 16	36/40	BW	<b>40565-91B</b>	<b>\$178.95</b>
'08-'13 XR1200/X	Stock '08-'10	D209HD	180/55ZR17	5.50 x 17	42	BW	<b>43231-08</b>	<b>\$301.95</b>
<b>MICHELIN® HARLEY-DAVIDSON® TIRE SERIES</b>								
'04-later XL (except XR1200/X, XL1200T or '11-later XL883L)	Stock on MY '11-later (except XL1200V)	SCORCHER 31	150/80B16	3.00 x 16	36/40	BW	<b>40878-11</b>	<b>\$234.95</b>
'08-'13 XR1200/X	Stock on MY '12	SCORCHER 11	180/55ZR17	5.50 x 17	42	BW	<b>43200011</b>	<b>\$299.95</b>
'11-later XL883L	Stock	SCORCHER 11	150/60ZR17	4.50 x 17	36/40	BW	<b>43216-11</b>	<b>\$220.95</b>
'14-later XL1200T	Stock	Scorcher 11T	150/70ZR17	4.50 x 17	42	BW	<b>43200026</b>	<b>\$259.95</b>

### Sidewall Style Key:

**BW** – Blackwall  
**SWW** – Slim Whitewall  
**MWW** – Medium Whitewall  
**WWW** – Wide Whitewall  
**EWWW** – Engraved Wide Whitewall

Notice: Suggested retail prices are subject to change.  
 Please see [harley-davidson.com](http://harley-davidson.com) for the most current suggested retail prices on any product listed in this catalog. Actual retail prices may vary.



**WARNING:** Use only Harley-Davidson approved tires. See a Harley-Davidson dealer. Using non-approved tires or mixing approved tires from different manufacturers on the same motorcycle, can adversely affect stability, which could result in death or serious injury.



# ORIGINAL EQUIPMENT AND RECOMMENDED REPLACEMENT TIRES

Model Fitment	Stock or Optional Fitment	Tread	Size	Rim Size in Inches	PSI	Sidewall Style	Part Number	Price
<b>DYNA® – FRONT</b>								
<b>DUNLOP® HARLEY-DAVIDSON® PERFORMANCE TIRES</b>								
'02-later Dyna (except FXDF, FXDFSE and FXDWG models)	Optional	GT502F	100/90-19	2.15 x 19	30	BW	<b>40554-04A</b>	<b>\$165.95</b>
'00-'01 FXDX	Stock							
'93-later FXDWG	Stock MY '10-'11	GT502F	80/90-21	2.15 x 21	30	BW	<b>43117-09</b>	<b>\$169.95</b>
<b>DUNLOP® HARLEY-DAVIDSON® TIRE SERIES</b>								
'08-later FXDF	Stock	D427F	130/90B16	3.00 x 16	36	BW	<b>43218-08</b>	<b>\$199.95</b>
'09-'10 FXDFSE/2								
'12-later FLD	Stock	D402F	130/70B18	3.50 x 18	36	BW	<b>43371-07A</b>	<b>\$230.95</b>
'91-later Dyna models (except FXDF, FXDFSE/2 and FXDWG models)	Stock MY '91-'09	D401F	100/90-19	2.15 x 19	30	BW	<b>43112-91A</b>	<b>\$154.95</b>
'84-later FXR (except FXLR, FXR2)	Stock							
'83-later FXRT	Stock							
'81-'85 FX	Stock	D401F	90/90-19	2.15 x 19	30	BW	<b>40567-90A</b>	<b>\$158.95</b>
'82-'83 FXR (except FXRT)	Stock							
'93-'08 FXDWG	Stock							
'86-earlier FXWGG	Stock	D402F	MH90-21	2.15 x 21	30	BW	<b>43104-93A</b>	<b>\$145.95</b>
'94-earlier FXLR	Stock							
'99 FXR2	Stock							
'07-'08 FXDSE/2	Stock							
<b>MICHELIN® HARLEY-DAVIDSON® TIRE SERIES</b>								
'02-later Dyna (except FXDF, FXDFSE/2 and FXDWG models)	Stock MY '10-later	SCORCHER 31	100/90-19	2.15 x 19	30	BW	<b>43258-07B</b>	<b>\$165.95</b>
'08-later FXDF	Optional	SCORCHER 32	130/90B16	3.00 x 16	36	BW	<b>43100003</b>	<b>\$214.95</b>
'10-later FXDWG	Stock MY '12-later	SCORCHER 31	80/90-21	2.15 x 21	38	BW	<b>41036-12</b>	<b>\$169.95</b>
<b>DYNA – REAR</b>								
<b>DUNLOP® HARLEY-DAVIDSON® PERFORMANCE TIRES</b>								
'00-'01 FXDX	Stock	GT502	150/80B16	3.00 x 16	36/40	BW	<b>40555-04A</b>	<b>\$234.95</b>
'02-'05 Dyna	Optional							
'10-later FXDWG	Stock MY '10-'11							
Replacement Tire for Harley-Davidson Wide Tire Kits P/N 44075-04, 43705-06, 43768-06	Optional	GT502	180/60B17	4.50 x 17	40	BW	<b>43197-04B</b>	<b>\$329.95</b>
<b>DUNLOP® HARLEY-DAVIDSON® TIRE SERIES</b>								
'82-later FXR	Stock	D401	130/90B16	3.00 x 16	36/40	BW	<b>40565-91B</b>	<b>\$178.95</b>
'82-later FXRT	Stock							
'91-'01 Dyna (except '00-'01 FXDX)	Stock	D401	150/80B16	3.00 x 16	36/40	BW	<b>43264-02</b>	<b>\$203.95</b>
'02-'05 Dyna	Stock							
'08-later FXDF	Stock	D427	180/70B16	5.00 x 16	36/40	BW	<b>43228-08</b>	<b>\$294.95</b>
'09-'10 FXDFSE/2	Stock							
'07-'08 FXDSE/2	Stock	D407	170/60R17	4.50 x 17	38/42	BW	<b>41998-07</b>	<b>\$254.95</b>
'06-later Dyna (except '07-'08 FXDSE/2, '08-later FXDF)	Stock MY '06-'10	K591	160/70B17	4.50 x 17	36/40	BW	<b>43169-00A</b>	<b>\$237.95</b>
'12-later FLD	Stock	D401	160/70B17	4.50 x 17	40	BW	<b>43200015</b>	<b>\$296.95</b>
<b>MICHELIN® HARLEY-DAVIDSON® TIRE SERIES</b>								
'08-later FXDF	Optional	SCORCHER 32	180/70B16	5.00 x 16	36/40	BW	<b>43200004</b>	<b>\$294.95</b>
'06-later Dyna (except FLD, FXDF and '07-'08 FXDSE/2)	Stock MY '10-later	SCORCHER 31	160/70B17	4.50 x 17	36/40	BW	<b>43250-07B</b>	<b>\$246.95</b>
'10-later FXDWG	Stock MY '12-later	SCORCHER 31	180/60B17	4.50 x 17	40	BW	<b>43200005</b>	<b>\$329.95</b>

**Sidewall Style Key:**

- BW** – Blackwall
- SWW** – Slim Whitewall
- MWW** – Medium Whitewall
- WWW** – Wide Whitewall
- EWVVV** – Engraved Wide Whitewall

Notice: Suggested retail prices are subject to change. Please see [harley-davidson.com](http://harley-davidson.com) for the most current suggested retail prices on any product listed in this catalog. Actual retail prices may vary.



**WARNING:** Use only Harley-Davidson approved tires. See a Harley-Davidson dealer. Using non-approved tires or mixing approved tires from different manufacturers on the same motorcycle, can adversely affect stability, which could result in death or serious injury.

# 878 GARAGE

Tires – Softail® Models

## ORIGINAL EQUIPMENT AND RECOMMENDED REPLACEMENT TIRES

Model Fitment	Stock or Optional Fitment	Tread	Size	Rim Size in Inches	PSI	Sidewall Style	Part Number	Price		
<b>SOFTAIL® – FRONT</b>										
<b>DUNLOP® HARLEY-DAVIDSON® PERFORMANCE TIRES</b>										
'84-'07 FXST	Optional	GT502F	80/90-21	2.15 x 21	30	BW	<b>43117-09</b>	<b>\$169.95</b>		
'84-'07 FXSTB	Optional									
'84-'07 FXSTC	Optional									
'84-'07 FXSTD	Optional									
'84-'07 FXSTS	Optional									
<b>DUNLOP® HARLEY-DAVIDSON® TIRE SERIES</b>										
'87-later FLSTC	(BW) Stock (WWW) Stock MY '09-later	D402F	MT90B16	3.00 x 16	36	EWWW WWW SWW BW	<b>43124-94B</b> <b>43118-92A</b> <b>43115-91A</b> <b>43022-91A</b>	<b>\$276.95</b> <b>\$212.95</b> <b>\$203.95</b> <b>\$174.95</b>		
'90-'06 FLSTF	(BW) Stock									
'05-later FLSTN	(WWW) Stock									
'81-'08 FLSTS	(BW) Stock									
'05-'07 FLSTSC	(BW) Stock									
'08-'11 FLSTSB	(BW) Stock	D402F	MT90B16	3.00 x 16	36	WWW	<b>43118-92A</b>	<b>\$212.95</b>		
'14 FLSTNSE	Stock									
'05 FLSTFSE	Stock	D402F	MT90B16	3.00 x 16	36	BW	<b>43022-91A</b>	<b>\$174.95</b>		
'12-later FLS	Stock									
'07-later FLSTF	Stock	D408F	140/75R17	3.50 x 17	36	BW	<b>41474-06B</b>	<b>\$230.95</b>		
'10-later FLSTFB	Stock									
'06 FLSTFSE2	Stock	D408F	130/70R18	3.50 x 18	36	BW	<b>41999-07B</b>	<b>\$261.95</b>		
'10-'12 FLSTSE/2/3	Stock									
'08-'09 FXSTSSE2/3	Stock	D408F	90/90-19	2.15 x 19	30	BW	<b>41566-08B</b>	<b>\$158.95</b>		
'08-'09 FXCW	Stock									
'08-'11 FXCWC	Stock	D408F	130/60B21	3.50 x 21	30	BW	<b>43100008</b>	<b>\$185.95</b>		
'13-'15 FXSB/FXSBSE/2	Stock									
'84-'07 FXST	Stock	D402F	MH90-21	2.15 x 21	30	BW	<b>43104-93A</b>	<b>\$145.95</b>		
'84-'07 FXSTB	Stock									
'84-'07 FXSTC	Stock									
'84-'07 FXSTD	Stock									
'04 FXSTDSE2	Stock									
'84-'07 FXSTS	Stock	D408F	MH90-21	2.15 x 21	30	BW	<b>43390-08A</b>	<b>\$151.95</b>		
'07 FXSTSSE	Stock									
'11-'13 FXS	Stock									
'08-later FXST	Stock									
'08-'09 FXSTB	Stock									
'08-'10 FXSTC	Stock	<b>MICHELIN® HARLEY-DAVIDSON® TIRE SERIES</b>								
'07-later FLSTF	Optional	SCORCHER 11	140/75R17	3.50 x 17	36	BW	<b>43100016</b>	<b>\$230.95</b>		
'10-later FLSTFB										

### Sidewall Style Key:

- BW** – Blackwall
- SWW** – Slim Whitewall
- MWW** – Medium Whitewall
- WWW** – Wide Whitewall
- EWWW** – Engraved Wide Whitewall

Notice: Suggested retail prices are subject to change.  
Please see [harley-davidson.com](http://harley-davidson.com) for the most current suggested retail prices on any product listed in this catalog. Actual retail prices may vary.



**WARNING:** Use only Harley-Davidson approved tires. See a Harley-Davidson dealer. Using non-approved tires or mixing approved tires from different manufacturers on the same motorcycle, can adversely affect stability, which could result in death or serious injury.



# ORIGINAL EQUIPMENT AND RECOMMENDED REPLACEMENT TIRES

Model Fitment	Stock or Optional Fitment	Tread	Size	Rim Size in Inches	PSI	Sidewall Style	Part Number	Price
<b>SOFTAIL® – REAR</b>								
<b>DUNLOP® HARLEY-DAVIDSON® PERFORMANCE TIRES</b>								
'03-'05 Softail (except FXSTD, FLSTS)	Optional							
Replacement tire for Harley-Davidson Wide Tire Kits P/N 43684-99A, 43685-00A, 44490-00A	Optional	GT502	150/80B16	3.00 x 16	36/40	BW	<b>40555-04A</b>	<b>\$234.95</b>
'04 FXSTDSE2	Optional	GT502	180/60B17	4.50 x 17	40	BW	<b>43197-04B</b>	<b>\$329.95</b>
<b>DUNLOP® HARLEY-DAVIDSON® TIRE SERIES</b>								
'87-'02 FLSTC	(BW) Stock							
'90-'02 FLSTF	(BW) Stock							
'97-'02 FLSTS	(WWW) Stock	D402	MT90B16	3.00 x 16	36/40	EWWW WWW SWW BW	<b>43125-94B</b> <b>43119-92A</b> <b>43114-91B</b> <b>43102-91B</b>	<b>\$304.95</b> <b>\$240.95</b> <b>\$231.95</b> <b>\$203.95</b>
'95-'02 FXSTC	(BW) Stock							
'95-'02 FXSTS	(BW) Stock							
'99-'02 FXSTB	Stock	D402	MT90B16	3.00 x 16	36/40	BW	<b>43102-91B</b>	<b>\$203.95</b>
'05-later FLSTN	(WWW) Stock							
'03 FLSTS	(WWW) Stock	D402	MU85B16	3.00 x 16	36/40	EWWW WWW SWW BW	<b>43167-08</b> <b>43353-03</b> <b>43332-04</b> <b>43200001</b>	<b>\$299.95</b> <b>\$251.95</b> <b>\$242.95</b> <b>\$211.95</b>
'11-'13 FXS	(BW) Stock							
'12-later FLS	Stock	D402	MU85B16	3.00 x 16	40	BW	<b>43200001</b>	<b>\$211.95</b>
'84-'94 FXSTC	Stock	D401	130/90B16	3.00 x 16	36/40	BW	<b>40565-91B</b>	<b>\$178.95</b>
'84-'94 FXSTS	Stock	D401	130/90B16	3.00 x 16	36/40	BW	<b>40565-91B</b>	<b>\$178.95</b>
'03-later FLSTC	(BW) Stock (WWW) Stock MY '09-later (SWW) Option (EWWW) Option	D401 D402 D402 D402	150/80B16 MU85B16 MU85B16 MU85B16	3.00 x 16	36/40	BW WWW SWW EWWW	<b>43264-02</b> <b>43353-03</b> <b>43332-04</b> <b>43167-08</b>	<b>\$203.95</b> <b>\$251.95</b> <b>\$242.95</b> <b>\$299.95</b>
'03-'05 Softail (except FXSTD, FLSTS)	Stock							
'06 FLSTF	Stock	D401	150/80B16	3.00 x 16	36/40	BW	<b>43264-02</b>	<b>\$203.95</b>
'05 FLSTFSE	Stock							
'05-later FLSTSC	Stock							
'07-later FLSTF	Stock							
'10-later FLSTFB	Stock							
'06 FLSTFSE2	Stock							
'06-later FXST	Stock							
'06-later FXSTB	Stock	D407	200/55R17	6.00 x 17	42	BW	<b>43242-06B</b>	<b>\$260.95</b>
'06-later FXSTC	Stock							
'06-later FXSTS	Stock							
'07-'08 FXSTSSE/2	Stock							
'08-later FLSTSB	Stock	D401	200/55R17	6.00 x 17	42	BW	<b>43970-08</b>	<b>\$240.95</b>
'00-'07 FXSTD (except '04 FXSTDSE2)	Stock	K591	160/70B17	4.50 x 17	36/40	BW	<b>43169-00A</b>	<b>\$237.95</b>
'08-'09 FXCW	Stock							
'08-'11 FXCWC	Stock							
'13-'15 FXSB/FXSBSE/2	Stock	D407	240/40R18	8.00 x 18	42	BW	<b>41688-08A</b>	<b>\$314.95</b>
'09 FXSTSSE3	Stock							
'10-'12 FLSTSE/2/3	Stock	D407	200/50R18	6.00 x 18	42	BW	<b>41771-10</b>	<b>\$270.95</b>
<b>MICHELIN® HARLEY-DAVIDSON® TIRE SERIES</b>								
'07-later FLSTF								
'10-later FLSTFB	Optional	SCORCHER 11	200/55R17	6.00 x 17	42	BW	<b>43200022</b>	<b>\$269.95</b>

**Sidewall Style Key:**

- BW** – Blackwall
- SWW** – Slim Whitewall
- MWW** – Medium Whitewall
- WWW** – Wide Whitewall
- EWWW** – Engraved Wide Whitewall

Notice: Suggested retail prices are subject to change. Please see harley-davidson.com for the most current suggested retail prices on any product listed in this catalog. Actual retail prices may vary.



**WARNING:** Use only Harley-Davidson approved tires. See a Harley-Davidson dealer. Using non-approved tires or mixing approved tires from different manufacturers on the same motorcycle, can adversely affect stability, which could result in death or serious injury.

# 880 GARAGE

Tires – Touring Models

## ORIGINAL EQUIPMENT AND RECOMMENDED REPLACEMENT TIRES

Model Fitment	Stock or Optional Fitment	Tread	Size	Rim Size in Inches	PSI	Sidewall Style	Part Number	Price
<b>TOURING – FRONT</b>								
<b>DUNLOP® HARLEY-DAVIDSON® TIRE SERIES</b>								
'15 FLTRUSE	Stock	D408F	130/80B17	3.00 x 17	36	BW	<b>43109-09A</b>	<b>\$227.95</b>
'14-later FLHR	Stock							
'14-later FLHTCU	Stock							
'14-later FLHTK/FLHTKSE	Stock							
'14-later FLHP	Stock							
'14-later FLHTP	Stock	D408F	130/60B19	3.50 x 19	36	BW	<b>43100013</b>	<b>\$192.95</b>
'15 FLTRX	Stock							
'15 FLTRXS	Stock							
'14 FLHX	Stock							
'14 FLHXS	Stock							
'15 FLHXSE	Stock	D402F	MT90B16	3.00 x 16	36	WWW	<b>43118-92A</b>	<b>\$212.95</b>
'14-later FLHRC	Stock							
'05 FLHTCSE2	Stock							
'06-'08 FLHTCUSE/2/3	Stock							
'09-'13 FLHRC and FLHRC/TLE Sidecar	Stock							
'09-'13 FLHP/E FLHTP	Stock	D408F	130/80B17	3.00 x 17	36	WWW	<b>43211-09A</b>	<b>\$235.95</b>
'09-'13 FLHR	(SWW) Stock							
'09-'13 FLHT	Optional							
'09-'13 FLHTC/U	(SWW) Stock							
'09-'13 FLHTCUSE4/5/6/7/8	Optional							
'10-'13 FLHTK	(SWW) Stock	D408F	130/80B17	3.00 x 17	36	BW SWW	<b>43109-09A</b> <b>43115-09A</b>	<b>\$227.95</b> <b>\$235.95</b>
'09 FLHX	(BW) Stock							
'09-'13 FLTR/U	(BW) Stock							
'09-'13 TLE Sidecar (except FLHRC/TLE)	Optional							
'04-'08 FL Touring models equipped with 18" accessory Front Wheel (except '07-'08 FLHRSE)	Optional							
'07-'08 FLHRSE3/4	Optional	D408F	130/70R18	3.50 x 18	36	BW	<b>41999-07B</b>	<b>\$261.95</b>
'10-'13 FLHX and FLTRX	Stock							
'10 FLHXSE	Stock							
'09 FLTRSE3	Stock							
'11 FLTRUSE	Stock							
'11-'12 FLHXSE2/3	Stock	D408F	130/70B18	3.50 x 18	36	BW	<b>44026-09A</b>	<b>\$212.95</b>
'13 FLHRSE5	Stock							
'12-'13 FLTRXSE/2	Stock							
'13-earlier Touring models equipped with 19" Agitator wheels	Optional							
'81-'08 FLH	Optional							
'81-'08 FLHR (except '07-'08 FLHRSE/2)	(SWW) Stock							
'81-'08 FLHRC	(WWW) Stock							
'81-'08 FLHS	Optional							
'81-'08 FLHT	(BW) Stock							
'81-'08 FLHTC/U	(SWW) Stock	D402F	MT90B16	3.00 x 16	36	EWWW WWW SWW BW	<b>43124-94B</b> <b>43118-92A</b> <b>43115-91A</b> <b>43022-91A</b>	<b>\$276.95</b> <b>\$212.95</b> <b>\$203.95</b> <b>\$174.95</b>
'81-'08 FLHX	(BW) Stock							
'81-'08 FLT	(BW) Stock							
'81-'08 FLTR	(BW) Stock							
'04-'08 TLE/Ultra Sidecar	Optional							
<b>TRIKE – FRONT</b>								
<b>DUNLOP® HARLEY-DAVIDSON® TIRE SERIES</b>								
'15 FLRT	Stock	D408F	130/60B19	3.50 x 19	36	BW	<b>43100013</b>	<b>\$192.95</b>
'09-later FLHTCUTG	(BW) Stock							
'10-'11 FLHXXX	(BW) Stock							
		D402F	MT90B16	3.00 x 16	36	EWWW WWW SWW BW	<b>43124-94B</b> <b>43118-92A</b> <b>43115-91A</b> <b>43022-91A</b>	<b>\$276.95</b> <b>\$212.95</b> <b>\$203.95</b> <b>\$174.95</b>

### Sidewall Style Key:

- BW** – Blackwall
- SWW** – Slim Whitewall
- MWW** – Medium Whitewall
- WWW** – Wide Whitewall
- EWWW** – Engraved Wide Whitewall

Notice: Suggested retail prices are subject to change.  
Please see [harley-davidson.com](http://harley-davidson.com) for the most current suggested retail prices on any product listed in this catalog. Actual retail prices may vary.



**WARNING:** Use only Harley-Davidson approved tires. See a Harley-Davidson dealer. Using non-approved tires or mixing approved tires from different manufacturers on the same motorcycle, can adversely affect stability, which could result in death or serious injury.



# ORIGINAL EQUIPMENT AND RECOMMENDED REPLACEMENT TIRES

Model Fitment	Stock or Optional Fitment	Tread	Size	Rim Size in Inches	PSI	Sidewall Style	Part Number	Price
<b>TOURING – REAR</b>								
<b>DUNLOP® HARLEY-DAVIDSON® TIRE SERIES</b>								
'14-later Touring (except FLHRC, FLHRSE6E)	Stock	D407T	180/65B16	5.00 x 16	40	BW	<b>43200027</b>	<b>\$290.95</b>
'14 FLHRSE6	Stock	D407	180/55B18	5.00 x 18	40	BW	<b>44006-09</b>	<b>\$296.95</b>
'14-later FLHRC	Stock	D407	180/65B16	5.00 x 16	40	WWW	<b>43230-09</b>	<b>\$308.95</b>
'09-'13 FLHP/E FLHTP	Stock	D407T	180/65B16	5.00 x 16	40	BW	<b>43200027</b>	<b>\$290.95</b>
'09-'13 FLHRC	Stock	D407	180/65B16	5.00 x 16	40	WWW	<b>43230-09</b>	<b>\$308.95</b>
'09-'13 FLHTC	(SWW) Stock							
'09-'13 FLHTCU	(SWW) Stock							
'09-'13 FLHR	(SWW) Stock							
'09-'13 FLHT	(BW) Stock	D407T	180/65B16	5.00 x 16	40	BW	<b>43200027</b>	<b>\$290.95</b>
'09-'13 FLHTCUSE4/5/6/7/8	(BW) Stock	D407	180/65B16	5.00 x 16	40	SWW	<b>43332-09</b>	<b>\$301.95</b>
'10-'13 FLHTK	(SWW) Stock							
'09-'13 FLHX	(BW) Stock							
'09-'13 FLTR/U	(BW) Stock							
'10-'13 FLTRX	(BW) Stock							
'05 FLHTCSE2	Stock	D402	MU85B16	3.00 x 16	36/40	BW	<b>43200001</b>	<b>\$211.95</b>
'06-'08 FLHTCUSE/2/3								
'04-'08 FLHX	Stock	D402	MU85B16	3.00 x 16	36/40	BW	<b>43200001</b>	<b>\$211.95</b>
	Optional					SWW	<b>43332-04</b>	<b>\$242.95</b>
'04-'08 FLHR (except '07-'08 FLHRSE/2)	(SWW) Stock							
'04-'08 FLHRC	(WWW) Stock							
'04-'08 FLHT	(BW) Stock	D402	MU85B16	3.00 x 16	36/40	EWWW	<b>43167-08</b>	<b>\$299.95</b>
'04-'08 FLHTC	(SWW) Stock					WWW	<b>43353-03</b>	<b>\$251.95</b>
'04-'08 FLHTCU	(SWW) Stock					SWW	<b>43332-04</b>	<b>\$242.95</b>
'04-'08 FLTR	(BW) Stock					BW	<b>43200001</b>	<b>\$211.95</b>
'81-'03 FLH	(SWW) Stock							
'81-'03 FLHR	(SWW) Stock							
'81-'03 FLHRC	(WWW) Stock							
'81-'03 FLHS	(SWW) Stock							
'81-'03 FLHT	(SWW) Stock	D402	MT90B16	3.00 x 16	36/40	EWWW	<b>43125-94B</b>	<b>\$304.95</b>
'81-'03 FLHTC/U	(SWW) Stock					WWW	<b>43119-92A</b>	<b>\$240.95</b>
'81-'03 FLT	(SWW) Stock					SWW	<b>43114-91B</b>	<b>\$231.95</b>
'81-'03 FLTR	(SWW) Stock					BW	<b>43102-91B</b>	<b>\$203.95</b>
'81-'03 CLE, RLE, TLE/Ultra Sidecar	(SWW) Stock							
'07-'08 FLHRSE/2	Stock	D407	170/60R17	4.50 x 17	38/42	BW	<b>41998-07</b>	<b>\$254.95</b>
'13 FLHRSE5	Stock							
'10-'12 FLHXSE/2/3	Stock							
'09 FLTRSE	Stock	D407	180/55B18	5.00 x 18	40	BW	<b>44006-09</b>	<b>\$296.95</b>
'11 FLTRUSE	Stock							
'12-'13 FLTRXSE/2	Stock							
<b>TRIKE – REAR</b>								
<b>DUNLOP® HARLEY-DAVIDSON® TIRE SERIES</b>								
'15 FLRT	Stock							
'09-later FLHTCUTG	Stock	SIGNATURE	P205/65R15	5.50 x 15	26	BW	<b>83324-09A</b>	<b>\$167.95</b>
'10-'11 FLHXXX	Stock							
H-D Trike models equipped with accessory wheel P/N 55069-11 or 55130-11	Optional	SIGNATURE	P205/60R16	5.50 x 16	26	BW	<b>83665-11A</b>	<b>\$171.95</b>

**Sidewall Style Key:**

- BW** – Blackwall
- SWW** – Slim Whitewall
- MWW** – Medium Whitewall
- WWW** – Wide Whitewall
- EWWW** – Engraved Wide Whitewall

Notice: Suggested retail prices are subject to change. Please see [harley-davidson.com](http://harley-davidson.com) for the most current suggested retail prices on any product listed in this catalog. Actual retail prices may vary.



**WARNING:** Use only Harley-Davidson approved tires. See a Harley-Davidson dealer. Using non-approved tires or mixing approved tires from different manufacturers on the same motorcycle, can adversely affect stability, which could result in death or serious injury.

# 882 GARAGE

Tires – Street™ & VRSC™ Models

## ORIGINAL EQUIPMENT AND RECOMMENDED REPLACEMENT TIRES

Model Fitment	Stock or Optional Fitment	Tread	Size	Rim Size in Inches	PSI	Sidewall Style	Part Number	Price
<b>VRSC™ – FRONT</b>								
<b>DUNLOP® HARLEY-DAVIDSON® TIRE SERIES</b>								
'02-later VRSC™ models	Stock MY '02-'10	D208F	120/70ZR19	3.00 x 19	36	BW	<b>43172-01B</b>	<b>\$226.95</b>
<b>MICHELIN® HARLEY-DAVIDSON® TIRE SERIES</b>								
'07-'10 VRSCAW	Optional	SCORCHER 11	120/70ZR19	3.00 x 19	36	BW	<b>43213-11</b>	<b>\$239.95</b>
'07-'08 VRSCD	Optional							
'07-later VRSCDX	Stock MY '11-later							
'09-later VRSCF	Stock MY '11-later							
'06 VRSCSE2	Optional							
'07 VRSCX	Optional							
<b>VRSC – REAR</b>								
<b>DUNLOP® HARLEY-DAVIDSON® TIRE SERIES</b>								
'07-'10 VRSCAW	Stock	D419	240/40R18	8.00 x 18	42	BW	<b>41473-06</b>	<b>\$289.95</b>
'07-later VRSCDX	Stock MY '07-'10							
'09-later VRSCF	Stock MY '07-'10							
'06 VRSCSE2	Stock							
'07 VRSCX	Stock							
Replacement Tire for Harley-Davidson Wide Tire Kit P/N 43687-06	Optional							
'02-'08 VRSC (except '06 VRSCSE2, VRSCAW, VRSCDX, VRSCX and VRSCF).	Stock	D207	180/55ZR18	5.50 x 18	38/42	BW	<b>43173-01</b>	<b>\$282.95</b>
<b>MICHELIN® HARLEY-DAVIDSON® TIRE SERIES</b>								
'06 VRSCSE2	Optional	SCORCHER 11	240/40R18	8.00 x 18	42	BW	<b>43189-11</b>	<b>\$319.95</b>
'07-'10 VRSCAW	Optional							
'07-later VRSCDX	Stock MY '11-later							
'07 VRSCX	Optional							
'09-later VRSCF	Stock MY '11-later							
<b>STREET™ – FRONT</b>								
<b>MICHELIN® HARLEY-DAVIDSON® TIRE SERIES</b>								
'15 XG	Stock	SCORCHER 11	100/80R17	2.50 x 17	34	BW	<b>43100017</b>	<b>\$164.95</b>
<b>STREET – REAR</b>								
<b>MICHELIN® HARLEY-DAVIDSON® TIRE SERIES</b>								
'15 XG	Stock	SCORCHER 11	140/75R15	3.50 x 15	42	BW	<b>43200023</b>	<b>\$224.95</b>

## RECOMMENDED REPLACEMENT INNER TUBES AND RIM BANDS

Dunlop® Inner Tubes	Part Number	Price
16" MT/MU90-16 Side Metal Valve	<b>40558-82</b>	<b>\$32.95</b>
16" MT/MU90-16 Center Metal Valve	<b>40575-05</b>	<b>\$33.95</b>
16" 180/65-16 Center Metal Valve	<b>40592-09</b>	<b>\$32.95</b>
17" 130/80-17 Center Metal Valve	<b>40593-09</b>	<b>\$30.95</b>
17" 160/70-180/60-17 Center Metal Valve	<b>40502-06</b>	<b>\$32.95</b>
17" 200/55R17 Center Metal Valve	<b>41491-08</b>	<b>\$45.95</b>
19" MJ/MM90-19 Center Metal Valve with Adapter Ring	<b>41188-06</b>	<b>\$28.95</b>
19" 120/70R19 Center Metal Valve	<b>41007-07</b>	<b>\$38.95</b>
21" MH90-21 Center Metal Valve	<b>43140-80</b>	<b>\$27.95</b>
Dunlop Rim Bands	Part Number	Price
16" Center Valve Smooth Profile Rim	<b>43164-05</b>	<b>\$4.49</b>
16" MT90-16 Side Valve Rim	<b>43147-40</b>	<b>\$3.95</b>
16" 180/65-16 Center Valve Rim	<b>43099-09</b>	<b>\$6.95</b>
17" Center Valve Rim	<b>43101-06</b>	<b>\$5.49</b>
17" Center Valve Radical Rim	<b>40916-08</b>	<b>\$8.95</b>
17" 130/80-17 Center Valve Rim	<b>43341-09A</b>	<b>\$4.95</b>
19" Center Valve Rim	<b>43145-47</b>	<b>\$3.95</b>
19" Center Valve Radial Rim	<b>41996-07</b>	<b>\$3.95</b>
21" Center Valve Rim	<b>43939-89</b>	<b>\$3.95</b>

Michelin® Inner Tubes	Part Number	Price
17" Center Metal Valve Fits 17" 160/70-17 and 180/60-17 tire/rim	<b>41314-10</b>	<b>\$30.95</b>
19" Center Metal Valve Fits 19" 100/90-19 tire/rim	<b>41316-10</b>	<b>\$25.95</b>
19" Center Metal Valve Fits VRSC models with 120/10-19 Radial front tires.	<b>43233-11</b>	<b>\$24.95</b>
16" Side Metal Valve Fits 130/90-16, 150/80-16, MT90-16 and MU85-16 tire/rim	<b>40572-11</b>	<b>\$31.95</b>
16" Center Metal Valve Fits 130/90-16, 150/80-16, MT90-16 and MU85-16 tire/rim	<b>40876-11</b>	<b>\$31.95</b>
21" Center Metal Valve Fits 80/90-21 and MH90-21 tire/rim	<b>40941-12</b>	<b>\$22.95</b>
Michelin Rim Bands	Part Number	Price
17" Center Valve Rim (4.5" x 17"/18")	<b>41319-10</b>	<b>\$5.49</b>
19" Center Valve Rim (1.6"/2.0" x 18"/19")	<b>41323-10</b>	<b>\$3.95</b>
19" VRSC 120/10-19 Radial Rim (2.15"/3" x 17"/18"/19")	<b>42039-11</b>	<b>\$6.95</b>
16" Side Metal Valve Rim (3" x 16")	<b>40875-11</b>	<b>\$3.95</b>
16" Center Metal Valve Rim (3" x 16")	<b>40877-11</b>	<b>\$3.95</b>
21" Center Metal Valve Rim (1.6"/1.85" x 17"/18"/19")	<b>40954-12</b>	<b>\$3.95</b>

Notice: Suggested retail prices are subject to change.  
Please see [harley-davidson.com](http://harley-davidson.com) for the most current suggested retail prices on any product listed in this catalog. Actual retail prices may vary.



**WARNING:** Use only Harley-Davidson approved tires. See a Harley-Davidson dealer. Using non-approved tires or mixing approved tires from different manufacturers on the same motorcycle, can adversely affect stability, which could result in death or serious injury.



<b>STREET™</b>	
Windshields	16
Handlebars	16
Seating	17
Backrests & Racks	19
Saddlebags & Luggage	20-21
Engine Trim	22
Chassis Trim	23
Hand & Foot Controls	24-25
Wheels & Brakes	26
Engine Guards	27
Screamin' Eagle® Performance	28-29
Color Shop	29

<b>VRSC™</b>	
Windshields	38
Seating	39-40
Backrests & Racks	40-41
Saddlebags	42
Engine/Chassis Trim	43-45
Chassis Trim – Front End	46-47
Chassis Trim – Rear End	48
Wheels, Sprockets & Brakes	49-50
Hand & Foot Controls	51-55
Engine Guards	55
Lighting	56-57

<b>SPORTSTER®</b>	
Windshields	74-77
Seating	78-85
Backrests & Racks	86-94
Saddlebags & Luggage	95-100
Fit Shop/Suspension	101-102
Foot Controls & Highway Pegs	103-108
Engine Guards & Soft Lower	106-107
Gauges	109
Chassis Trim – Front End	110-112
Chassis Trim – Brakes	113
Chassis Trim – Rear End	114-116
Engine Trim	117-123
Oil Coolers & Dipsticks	125
Chassis Trim – Bodywork	124-127

<b>DYNA®</b>	
Windshields	142-146
Seating	147-155
Backrests & Racks	156-164
Saddlebags & Luggage	165-169
Tank & Chassis Trim	170-173
Fit Shop/Suspension	174-175
Foot Controls & Highway Pegs	176-183
Engine Guards & Soft Lower	184-185
Chassis Trim – Front End	186-193
Chassis Trim – Brakes	190-191
Chassis Trim – Rear End	194-199

<b>SOFTAIL®</b>	
Windshields	216-224
Seating	225-238
Backrests & Racks	239-249
Saddlebags & Luggage	250-263
Tank & Console Trim	264-266
Fit Shop/Suspension	267-269
Foot Controls	270-279
Engine Guards & Soft Lower	280-281
Highway Pegs	282-283
Chassis Trim – Front End	284-294
Chassis Trim – Rear End	295-301
Chassis Trim – Brakes	302-304
Chassis Trim – Bodywork	305-307

<b>TOURING &amp; TRIKE</b>	
Windshields	336-348
Fairing Lower & Accessories	349-353
Seating	354-372
Backrests & Racks	373-385
Tour-Pak® Luggage	386-392
Tour-Pak Accessories	393-402
Saddlebags & Accessories	402-414
Luggage Accessories	415-423
Paint Protection	421-423
Charging Accessories	424-425
Fit Shop/Suspension	426-429
Foot Controls	430-439
Engine Guards & Jiffy Stands	440-441
Chassis Trim – Front End	442-456
Chassis Trim – Brakes	448-450
Chassis Trim – Bodywork	451-456
Chassis Trim – Fairing & Console	457-470
Chassis Trim – Rear End	471-475

<b>SCREAMIN' EAGLE®</b>	
Air Cleaner Kits & Filters	479-491
Exhaust Systems	492-509
Street Tuner	510
XL & Twin Cam Stage Kits	511-515
Engine Components	516-521
Ignition	522-523
Clutch & Drivetrain	524-527
Crate Engines & Short Block	528-530
LongBlock Program	531-533

<b>ENGINE TRIM</b>	
Derby, Timer & Air Cleaner Trim	536-547
Air Cleaner Covers	548-550
Engine Trim – Big Twin	551-563
Oil Coolers	564-565
Oil Level Dipsticks	566-567
Cylinder Head Covers	568-569
Hardware Covers & Hardware	570-575

<b>CONTROLS</b>	
Hand Grip & Foot Control Collections	578-597
Footpegs & Footboards	598-600
Highway Pegs & Footpeg Hardware	601-603
Mirrors	604-609
Hand Controls & Levers	610-616
Control Cables & Brake Lines	617-619
Handlebars	620-637
Handlebar Risers	638-641

<b>AUDIO &amp; GAUGES</b>	
Boom!™ Audio – Touring Bikes	644-661
Boom! Audio – Cruiser Bikes	662-663
Antenna Systems	664-665
GPS Navigation	666-668
Boom! Audio Accessories	669
Headsets	670-671
Auxiliary Power & Charging	672-673
Speedometers/Tachometers	674-678
Oil Temp/Pressure/Level	678-679, 682
Fairing Mount Gauges	680-681
Gauge Trim	681
Clocks & Air Temp	683
Fuel Gauges, Caps & Medallions	684-689

<b>LIGHTING</b>	
Headlamps & Auxiliary Lighting	692-705
Turn Signals	706-713
Tail & Brake Lamps	713-717
Decorative LED Lighting	718-723
Lighting Trim	724-730
Electrical Accessories	731
Horns & Horn Covers	732-733
License Mounts & Accessories	734-737

<b>WHEELS</b>	
Custom Wheels	740-764
Custom Sprockets	765-767
Brake Rotors	767-770
Wheel Accessories	771

<b>LUGGAGE</b>	
Touring Luggage & Accessories	774-781
Swingarm, Fork & Sissy Bar Bags	782-783
Windshield & Fairing Bags	784-786
Storage & Travel-Paks	787-789
Tie-Downs & Accessories	789-790
Flags	791

<b>COLOR SHOP</b>	
Custom Seat Program	794-797
Custom Paint Sets	798-801
Color-Matched Accessories	802-815
Medallions & Decals	816-819

<b>GARAGE</b>	
Surface Care Products	822-831
Motorcycle Covers	832-836
Garage Storage	837-839
Motorcycle Lifts & Tie-Downs	840-843
Security Locks & Systems	844-850
Tire Gauges & Air Pumps	851
Oil Change Accessories	852-853
Battery Chargers	854-856
Flashlights	857
Tools	858-859
Oil & Lubricants, Solvents & Sealants	860-866
Paints	867
Batteries	868
Spark Plugs	869
Air & Oil Filters	870-872
Brake Pads	873
Tires	874-882

# 884 PART#/PAGE# REFERENCE

10800033	619	16200088	532	17675-01B	520	25282-11	518	25700195	119	27929-08	543
10800034	618	16200091	532	17707-11	552	25284-11	518	25700196	118	27937-08	544
10800035	618	16200092	532	17709-11	552	25307-06	117	25700197	119	27938-08	541
10800036	618	16200093	532	17900032	519	25330-98	541	25700249	536	27939-08	537
10800037	618	16200094	532	17900033	519, 559	25331-10	539	25700250	536	27956-10	539
10800038	619	16200095	532	17964-99	554	25332-98	121, 541	25700251	536	27957-10	120, 539
10800039	619	16200096	532	17966-99	554	25333-10	120, 539	25700255	120, 546	27958-10	539
10800055	683	16200097	532	17997-99A	519	25334-99A	545	25700256	546	27960-10	540
10800056	683	16200098	532	18013-03A	520	25336-06	544	25700257	120, 546	27961-10	121, 540
10800057	683	16200099	532	18088-02	559	25338-99A	541	25700258	546	27965-10	540
10800058	683	16200100	532	18096-00A	559	25339-10	540	25700307	22	28714-10	491, 871
11100001	865	16200101	532	18241-04	119	25340-99A	543	25700337	557	28716-10A	480
11100002	866	16200102	532	18248-99	559	25341-10	121, 540	25700385	551, 554	28720-10	481
11100003	865	16200103	532	18262-00	559	25364-01B	553	25700388	547, 551	28721-10	486
11100004	865	16200104	532	18278-06	559	25369-01B	554	25700434	538, 551	28722-10	486
11100005	865	16200105	532	18404-08	519	25372-02A	542	25700435	539, 551	28728-10	489, 550
11100006	865	16200106	532	18568-98	520	25391-84T	542	25700436	541, 551	28739-10	481
11100028A	422	16200108	532	18572-13	520	25391-90T	543	25700437	547, 551, 552	28740-10	481
11100044	866	16200109	532	19176-06D	529	25398-95T	122, 543	25700438	551	28741-10	481
11100078	422	16205-10	560	19176-15	529	25400-98	121	25913-99	571	28742-10	481
11100080	422	16213-10	560	19255-05C	529	25440-04A	121, 537	26082-05C	565	28861-07A	521
11100082	422	16295-07A	117, 555	19256-05C	529	25441-04A	537	26151-07	564	29000009A	487
11100086	422	16309-04A	44	19258-06D	529	25454-01	547	26155-07A	565	29000019A	487
11100097	422	16318-07B	554	19259-06D	529	25460-04	117	26155-09A	565	29000066	483, 536
11100098	422	16326-02	554	19264-06D	529	25460-06	117	26157-07A	564	29006-09B	480
11100125	423	16326-07B	554	19293-06D	529	25460-94	117	26157-11A	564	29017-09	481
11300002	863	16327-01A	554	19293-15	529	25464-06	516	26321-99A	561	29036-72	870
11300004	864	16327-06B	554	19296-06D	529	25482-10	516	26792-01	45	29080-09	480
11300005	863	16400020	116	19678-13A	529	25486-05	117	26808-04	45	29084-04DH	550
12600036	89, 159, 249, 375	16400022	116	19678-15	529	25503-10	516	26900107	22	29084-10BDK	550
12700020	851	16500046A	513	19811-15	529	25562-09	538	26900108	22	29098-09	480
12700022	857	17378-98	520	19973-15K	530	25563-09	120, 538	27040-88T	563	29119-08	489
12700024	857	17528-92	555	20022-15	530	25600002	546	27129-88T	563	29138-91A	548
12700025	857	17529-92	555	24004-03B	521	25600003	546	27351-96	563	29153-07	548
14093-84	816	17530-92	555	24017-10	518	25600025	120, 546	27353-96	563	29170-08	489
14100434	287, 445	17537-07A	117	24018-10	518	25600026	546	27477-04	563	29191-08	870
14100618	193, 292, 452	17537-96C	117	24400099	521	25600027	120, 546	27483-07A	561	29193-08DH	550
14813-03	818	17538-96	117	25125-04A	121, 545	25600028	546	27501-10A	515	29193-10BDK	550
14814-03	818	17551-04	117	25127-04A	122, 543	25600033	22	27505-10A	515	29200008A	224
14900033	858	17551-96	117	25130-04A	121, 541	25638-07	516	27508-11	515	29200011	146
16101-01	520	17572-99	554	25213-04	117	25700007	455, 565	27535-08	512	29200102BYM	805
16200070	530	17573-99A	554	25213-96B	117	25700020	547, 552	27539-08A	512	29200102DH	805
16200071	530	17618-99A	553	25231-04	118	25700021A	552	27543-08	513	29200102DST	805
16200085	532	17620-99	553	25233-04	118	25700062	546	27545-08	513	29200102DSW	805
16200086	532	17645-06A	117	25247-99	554	25700130	546	27557-08	513	29200102DWC	805
16200087	532	17645-07A	117	25256-93A	555	25700180	552	27564-09A	513	29243-97	541
		17655-05	117	25268-84A	555	25700194	118	27794-08	869	29253-08B	480



29259-86	870	29400172	479	29888-06	490, 549	32189-10	522, 869	32964-06	544	33900134	274, 434
29259-89	870	29400173	479	29898-06	490, 549	32192-10	522, 869	32972-04A	121, 537	33909-08A	270
29259-91A	870	29400178	483, 536	29900028	425, 673	32228-15	526	32975-04A	537	33915-09	274, 434
29260-08	488	29400197	28	29902-09	490, 549	32303-08	523	33006-14	526	33917-09	181
29264-08	480	29400217	485	29903-07A	512	32318-08	523	33040-03A	527	33919-00	563
29289-90T	543	29400218	485	29915-09	486	32325-08	523	33045-03A	527	33946-05	590
29291-95	870	29405-90T	122, 543	29929-07	490, 549	32331-05	869	33100-03A	527	34016-08	180, 271
29299-08	480	29406-08	488	29972-11	544	32335-04	869	33101-03A	527	34018-08	274, 434
29314-08	870	29415-99	545	29985-87	425	32336-04	869	33102-03A	527	34023-08	273, 433
29319-08	489	29416-04	121, 537	29999-97B	425	32337-04	869	33103-03A	527	34043-10	180, 271
29325-95A	870	29417-04	537	30003-10	511	32338-04	869	33104-03	527	34045-10	273, 433
29328-99	543	29424-05A	491, 871	31335-03A	560	32339-04	869	33111-02	561	34468-98A	554, 555
29330-96	870	29430-06	544	31559-99A	560	32342-04	869	33137-04	527	34469-01	554
29331-04	870	29431-97	563	31600012	869	32359-00B	523	33395-04	104	34469-06B	554
29331-96	870	29437-01A	870	31619-06A	560	32360-00B	523	33395-06A	104	34469-99B	554
29341-02	542	29462-99	870	31621-06A	560	32362-04	869	33397-07A	104	34521-06B	553
29377-08	870	29489-99C	488	31709-04	172	32365-04	869	33398-04	104	34535-00B	273, 433
29378-11	542	29490-09	486	31767-04	126	32367-04	869	33398-06A	104	34539-00	180, 271
29382-97A	489	29503-07	489	31783-00	119, 560	32414-09	120, 538	33401-05	123, 562	34541-00	554
29383-97A	489	29506-09	490, 549	31901-08	523	32415-09	538	33600001	273, 431	34544-00	553
29400015	870	29509-06	870	31902-08	523	32519-10	539	33600008	584	34551-09	54
29400019	491, 871	29510-05	489	31907-08	523	32520-10	120, 539	33600032	25, 583	34555-01A	54
29400020	491, 871	29567-99	489	31930-99B	523	32526-10	540	33600059	25, 583	34606-90T	103, 117
29400021	491, 871	29585-07DH	550	31932-99B	523	32541-10	121, 540	33698-07	276	34608-95	594
29400022A	491, 871	29585-10BDK	550	31937-99B	523	32571-98A	121, 545	33745-09	181	34617-03	591
29400026	491, 871	29586-06	489	31939-99B	523	32581-85T	542	33760-09	274, 434	34627-99	593
29400042	870	29600-00	571	31944-99B	523	32581-90TB	122, 543	33761-09	181	34633-85T	597
29400045	870	29619-99	489	31946-99B	523	32584-88TA	122, 547	33762-09	274, 434	34635-90T	595
29400061	481	29620-99	489	31956-04A	523	32585-89T	542	33778-09	103	34664-04	586
29400063	482	29624-08	489	31958-04A	523	32585-90T	122, 543	33801-09	274, 434	34669-09A	585
29400064	482	29633-08	870	31963-89A	523	32662-99A	545	33814-98A	274, 434	34671-10	24, 582
29400065	491, 871	29702-08A	491, 871	31964-89B	523	32666-98	541	33823-09	274, 434	34689-04	592
29400078	870	29703-00	571	31965-08	523	32668-98A	121, 541	33825-00	277	34690-08	24, 588
29400103	482	29745-00A	490, 549	31967-08	523	32677-01	547	33838-09	181	34699-04	592
29400104	482	29754-01	548	31987-85B	523	32679-99A	547	33840-09	274, 434	34760-04	117, 122, 547
29400109	491, 871	29765-01	548	32042-07	557	32689-99A	543	33851-09	434	34760-94	117
29400116	482	29769-01	548	32047-99A	541	32690-99A	571	33854-09	274	34761-04A	117, 122, 547
29400117	482	29770-01	45	32077-07	557	32698-02A	542	33857-09	434	34761-94	117, 122, 547
29400118	491, 871	29773-02C	488	32090-98	522	32700002	287	33867-02	54	34790-05	117, 122, 547
29400127	482	29782-07	487	32091-98	522	32714-98A	615	33872-06	181	34794-05A	117
29400128	482	29784-07	511	32092-98A	523	32715-98	198, 304, 450	33876-07	273, 433	34800007	119
29400129	488	29793-02C	487	32093-98A	523	32729-07	119	33878-04	181	34800008	119
29400141	491, 871	29820-11	539	32094-98	522	32732-98	119	33884-09	274, 434	34800012	536
29400163	484	29823-04	122, 543	32095-98A	523	32745-99	569	33891-98	104	34822-08	521
29400164	484	29824-04	121, 545	32184-08A	510	32747-99	569	33892-98	104	34840-09	103
29400167	484	29833-06	490, 549	32186-10	522, 869	32753-01	557	33900102	103	34848-09	181
29400168	484	29866-07B	515	32188-10	522, 869	32875-04	562	33900103	181	34850-09	274, 434

# 886 PART#/PAGE# REFERENCE

34856-06A	572	37976-08A	525	40754-08	755	40941-12	882	41420-08	189	41596-00A	299
34932-04	117	37980-10	525	40778-08	759	40954-12	882	41449-10	582	41597-00	189, 287
34932-96	117	38002-04	525	40779-08	759	40955-05	191, 303, 450	41451-08C	26, 741	41597-07	287
34943-05	117	38636-07	562	40790-09	759	40959-05	191, 303, 450	41453-08C	741	41600003	180
34944-04	118	38752-04	527	40792-09	759	40966-09	760	41454-08B	741	41600008	272
34967-04	596	38753-04A	527	40802-08	759	41000008B	510	41455-08C	741	41600012	431
35286-10	587	38792-05A	618	40820-08	753	41000018	510	41456-08C	741	41600079	432
35471-05	275, 433	38804-07	618	40875-11	882	41000021C	849	41458-08	443	41600082	432
35495-06	275	38843-08	614	40876-11	882	41000087B	849	41473-06	882	41610-02	443
36500020	526	38845-08	614	40877-11	882	41007-07	882	41474-06B	878	41616-02	111, 189
36700004	614	38853-08	615	40878-11	876	41036-12	876, 877	41491-08	882	41688-08A	879
36700052	614	40006-85	859	40879-11A	876	41088-09	288	41500002	767	41700190	610
36700053A	614	40063-05B	526	40881-09	760	41144-97	771	41500004	767	41700262	610
36700064	614	40079-10	272	40900009	753	41145-97	771	41500005	770	41700263A	610
36700065	614	40084-10	271	40900025	764	41146-97	771	41500007	767	41700297	613
36700066	615	40091-10	432	40900044	471	41148-98	771	41500008	767	41700324	610
36700067	614	40096-00	766	40900046	753	41149-98	771	41500012A	50, 751, 753, 756, 770	41704-09	196, 299
36700091	614	40100061	526	40900055	764	41150-98	771	41500032	757, 767	41705-09	196, 299
36700094	613	40120-09	199, 765	40900057	758	41161-01	737	41500034	757, 767	41706-09	196, 299
36700100	610	40121-09	301, 765	40900059	763	41170-03	737	41500036	757, 767	41771-10	879
36700104	614	40124-10	116, 765	40900061	763	41171-03	771	41500038	757, 767	41775-04B	271, 435
36700105	614	40126-00	766	40900063	763	41174-07	764	41500040	744, 750, 767	41777-05A	271, 435
36808-05	616	40126-07	766	40900065	763	41188-06	882	41500047	768	41800-08	272
37000026	524	40142-08	199, 765	40900067	750	41202-08	299	41500052	767	41800004	270
37000121	524	40150-08	301, 765	40900069	750	41221-08	299	41500053	767	41800005	270
37103-08	567	40225-10	746	40900071	756	41300004	873	41500058	768	41800219	862
37105-87A	555	40228-07	766	40900074	756	41300027	873	41500066	769	41800220	862
37105-99	554	40268-10	746	40900075	764	41300033	873	41500069	769	41805-08	271
37116-06	554	40279-91A	116	40900077	762	41300053	873	41500070	768	41815-00	277
37123-98A	567	40359-10	762	40900088	742	41300061	615	41500094	748, 749, 770	41830-05A	770
37135-06	553	40386-10	762	40900089	743	41300062	615	41500095	450, 771	41831-05A	770
37189-99	553	40410-09	766	40900111	755	41300072	873	41500096	26	41832-05A	770
37193-11	552	40418-04	766	40900112	746	41300102	873	41500097	26	41842-06	198, 304, 615
37195-11	552	40435-04	766	40900113	747	41300116	49, 448	41500102	745, 767	41843-08	449, 615
37198-11	552	40445-08	766	40900115	754	41300120	49, 113, 190, 448	41500103	745, 767	41844-06	449, 615
37200077	16	40447-01	766	40900197	759	41300126	113, 190, 302	41500106	770	41850-08	24, 588
37709-09	766	40447-07	766	40900324	758	41300127	190, 302	41500107	768	41852-08B	873
37756-07	199	40451-01	766	40900329	745	41300131	113	41500108	768	41854-08	873
37757-07	301, 765	40451-07	766	40900332	744	41300134	113	41500109	769	41880-07	755
37785-07	766	40474-03	766	40900346	749	41300142	113	41500110	769	41883-07	755
37800-08	766	40502-06	882	40900348	748	41319-10	882	41503-10	757	41886-07	755
37833-10	757, 766	40554-04A	876, 877	40900358	26	41323-10	882	41509-10	757	41886-09	755
37834-10	757, 766	40555-04A	876, 877, 879	40900359	26	41361-08	189	41566-08B	878	41889-07	755
37938-08KA	525	40556-06A	876	40900370	742	41362-08	194	41575-08	298	41889-09	755
37946-99	561	40565-91B	876, 877, 879	40900371	743	41370-08	111	41583-03	287	41981-08	759
37951-98	525	40567-90A	876, 877	40900391	748	41371-08	443	41583-07	287	41983-08	759
37970-03A	525	40593-09	882	40916-08	882					41996-07	882



41998-07	877, 881	42230-00	447	43000026	23, 46, 111, 187, 288, 446	43200001	879, 881	43300338	748	43848-08A	741
41999-07B	878, 880	42270-06B	52, 614	43000031	47, 111, 188, 288, 447	43200004	877	43300350	26	43850-96	571
42002-08	190	42275-07A	52, 614	43013-09A	115	43200005	877	43300351	26	43851-11A	741
42008-09	585	42298-08	873	43022-91A	876, 878, 880	43200007	876	43300367	742	43854-08A	741
42012-06A	49, 448	42300009	851	43051-01	188, 446	43200011	876	43300368	743	43857-00	568
42029-07	873	42307-04	610	43059-04	188, 446	43200015	877	43300369	742	43858-00	568
42034-07	196	42307-07	610	43061-04	187, 446	43200022	879	43300370	743	43859-00	568
42035-06	190	42310-08	873	43062-04	187, 446	43200026	876	43300371	742	43861-08A	741
42039-11	882	42313-04	613	43063-04	188, 446	43200027	881	43300372	743	43864-96	288, 446
42047-08	190, 303	42313-07	613	43077-11	741	43211-09A	880	43300386	748	43868-99	569
42048-08	303	42400003	741	43078-99	828	43213-11	882	43300388	744	43876-04	116, 301, 471
42053-05	47, 449	42400008	741	43099-09	882	43216-11	876	43332-04	879, 881	43878-08B	741
42054-05	47, 449	42400009A	741	43100003	877	43218-08	877	43332-09	881	43881-96	571
42064-07	196	42400010	741	43100004	876	43221-08	299	43341-09A	882	43884-96	569
42065-07	196	42476-95	594	43100008	878	43228-08	877	43353-03	879, 881	43890-93	123, 569
42069-08	298	42478-95	594	43100013	880	43229-08	876	43371-07A	877, 880	43894-90	288
42070-07	113	42554-03	591	43100016	878	43230-09	881	43390-08A	878	43896-99	123, 569
42072-07	115	42555-04	586	43100017	882	43231-08	876	43395-80A	873	43897-86B	297
42100-06A	53, 610	42560-09	585	43100021	876	43235-08	297	43422-09	196, 299	43899-86A	111, 187, 288, 446
42114-06A	53, 613	42623-00	589	43101-06	882	43242-06B	879	43428-09	46, 111, 187, 288, 446	43907-94	111, 188, 288, 446
42117-08	610	42629-00	24, 589	43102-91B	879, 881	43250-07B	877	43430-09	48	43911-95	569
42123-08	613	42632-07	271	43104-93A	876, 877, 878	43258-07B	876, 877	43462-00	297	43918-07	761
42134-06	284	42638-00A	272, 432	43109-09A	880	43264-02	876, 877, 879	43468-00	297	43919-07	761
42136-07	284	42638-03	431	43112-91A	876, 877	43300008	753	43538-09	761	43920-08	761
42155-07A	768	42638-08A	432	43114-91B	879, 881	43300010	287	43553-00	191, 304	43921-08	761
42156-07A	768	42640-00	272	43115-09A	880	43300018	764	43577-09	761	43925-07	761
42158-07A	769	42640-03	272	43115-91A	878, 880	43300034	753	43580-04	115	43928-08	761
42170-09	747	42650-08	586	43117-09	876, 877, 878	43300045	764	43602-07	760	43929-08	761
42171-09	747	42666-03	180	43118-92A	878, 880	43300047	758	43609-07	760	43931-08	761
42195-10	752	42679-01	603	43119-92A	879, 881	43300049	763	43634-08	50	43939-89	882
42196-10	752	42700-05	590	43124-94B	878, 880	43300051	763	43635-08	50	43942-07	761
42200001	766	42701-05	590	43125-94B	879, 881	43300053	763	43649-08	760	43943-01	569
42200004	766	42710-04	592	43132-08	196, 299	43300055	763	43703-08	760	43957-80A	873
42200007	766	42711-04	592	43140-80	882	43300057	750	43705-06	198	43957-86E	873
42200010	199, 765	42712-04	596	43145-47	882	43300059	750	43759-00	191, 304	43970-08	879
42200011	301, 765	42739-08	873	43147-40	882	43300062	756	43768-06	198	43972-08	761
42200012	199, 765	42831-04A	873	43161-97	288	43300064	756	43779-09	198	43973-08	761
42200013	301, 765	42836-04A	873	43163-08A	46, 111, 188, 288, 446	43300065	764	43798-00	447	44006-09	881
42200030	757, 766	42841-03	591	43164-05	882	43300067	762	43822-01	123, 569	44013-09A	447
42200031	766	42847-10	24, 582	43167-08	879, 881	43300114	755	43824-03	191, 303, 450	44026-09A	880
42200051	766	42850-06B	873	43169-00A	877, 879	43300115	746	43830-96	297	44055-07	761
42200064A	526	42897-06A	873	43172-01B	882	43300116	747	43833-07A	741	44056-07	761
42200066	742, 767	42897-08	873	43173-01	882	43300198	759	43834-98	198, 304, 450	44057-07	761
42200067	743, 767	42964-01A	54	43189-11	882	43300315	758	43835-98	123, 568	44063-83C	873
42200068	742, 767	43000018	23	43197-04B	877, 879	43300321	745	43840-01	568	44082-00D	873
42200069	743, 767	43000022	23			43300336	749	43841-01	568		

# 888 PART#/PAGE# REFERENCE

44082-08	873	44542-03	191, 305, 449	45500065	186	45848-03	189, 286, 445	46555-03B	456, 726	48218-10	89, 164, 249, 573
44093-96	191, 304, 449	44544-08	760	45500066	186	45896-98	405	46559-03	457	48220-10	89, 164, 249, 573
44095-96	191, 304, 449	44553-06A	751, 753, 756	45500067	186	45898-08DH	809	46562-04A	110	48221-10	89, 164, 249, 573
44100-95A	768	44621-04	113	45500073	186	45898-10BEO	809	46565-04	406	48223-10	89, 164, 249, 573
44101-95A	768	44622-04	113	45500074	186	45898-98	809	46595-06A	47, 189	48225-10	89, 164, 249, 573
44102-95A	769	44623-04	113	45500106	427	45963-97	286, 444	46624-03	766	48329-90A	112, 193
44108-95A	769	44700-03A	768	45500141	268	46086-98A	844	46640-07A	768	48434-05A	114
44109-07	47, 188, 288, 446	44703-03A	768	45500157	427	46089-98A	844	46641-07A	769	48452-00	300
44114-07	47, 188, 288, 446	44706-03A	769	45500158	427	46090-98A	844	46646-05	450, 771	48458-06	194
44116-07A	46, 111, 187, 288, 446	44729-09	447	45500167	442	46097-98	189, 287	46647-05	450, 771	48458-10	194
44117-07A	23, 46, 111, 187, 288, 446	44821-00A	768	45500171	442	46098-98	611	46718-08	588	48494-03	300
44135-74A	873	44822-00A	769	45500172	442	46099-98	611	46721-06A	873	48607-06	296
44148-07A	46, 111, 188, 288, 446	44940-08A	768	45500200	442	46109-06	192	46777-09A	769	48607-08A	296
44209-87C	873	44942-08A	768	45500226	110	46112-02D	53, 610	46778-09A	768	48608-09	291
44248-96	593	44944-08A	768	45500238	110	46114-07	52, 614	46809-09	290	48609-09	192
44254-01	299	44947-08A	768	45500258	110	46116-03	445	46873-09	180	48646-06A	284
44256-01	299	44950-08	770	45500261	110	46129-98B	112, 192, 289	46875-09	427	48875-07	305
44257-01	196	44959-08	770	45500267	186	46165-03	445	46883-09	432	48893-01	48
44262-01	196	44970-07	270	45500273	186	46192-99A	112, 189	46889-06	187	48977-10	757, 767
44282-07	760	44972-08	270	45591-02	286, 444	46282-07	447	46944-07A	614	48978-10	757, 767
44296-04	123	44992-07	614	45600006	444	46287-04	403	47059-01	297	48979-10	757, 767
44345-09	298	44994-07	614	45600022	444	46300-01	275	47200240	352	48981-10	767
44346-06	196	45002-98	192, 289	45600023	444	46301-01	434	47200278	457	48983-09	54
44357-00A	769	45023-02	193	45600031	444	46302-01	275	47245-05	306	48990-10	587
44358-00A	768	45047-06A	769	45600032	444	46303-01	434	47300-88T	300	48993-10	757, 767
44359-00A	769	45075-07	614	45621-02	48	46304-01	275	47498-09	474	49000-10	767
44360-00A	768	45078-96D	53, 613	45721-96A	846	46305-01	434	47596-91B	298	49000005	107
44365-00A	768	45118-06A	768	45732-86	21, 846	46316-04	403	47612-08	297	49000006	107
44366-00A	769	45149-99C	271, 435, 616	45737-72A	846	46318-04	844	47615-95B	298	49000015	27
44367-00A	768	45243-00	187, 286	45762-04	115	46321-05B	284	47625-09	115	49000047	27
44368-00A	769	45275-98	110, 186	45800010	186	46331-04	110	47630-09	297	49000069	472
44392-00A	49, 113, 190, 303, 448	45281-99D	610	45800011	186	46331-08A	110	47645-09	196	49000077	185
44395-00A	113, 190, 303	45284-99D	610	45800014	187	46363-11	873	47646-09	47, 188	49000078	185
44395-08	190, 303	45305-98	186, 285	45800015	192	46399-05A	115	47647-09	48	49002-98	179
44411-09A	768	45310-98	285	45800022	443	46418-05A	610	47649-09	297	49004-00A	280
44421-09A	769	45315-98	442	45800034	443	46424-05B	613	47660-09	297	49004-90	280
44432-04	123	45355-06A	610	45800035	443	46425-05A	181, 271, 435, 616	47663-09	297	49007-90A	184
44473-02A	304, 449	45355-08	610	45800036	443	46463-08	435, 616	47831-10	757	49010-06	184
44474-99	191, 305, 449	45400005	285	45800037	443	46477-00	186, 285	47835-10	757	49010-93	184
44476-99	191, 305, 449	45400006	285	45800038A	443	46482-00	285	47951-10	746	49016-72D	280
44477-99	191, 305, 449	45415-82	187, 286	45800053	23	46492-00	110, 186	47957-10	746	49018-88C	107
44497-02	45	45424-08	115	45800056	23	46526-02B	46	48035-09	89, 164, 249, 573	49019-95	179
44539-02A	303, 49	45480-05	102	45800075	186	46546-03	442	48180-98B	298	49021-09	176
		45500-09	102	45800076	186	46547-03A	456	48212-08	300	49023-02A	280
		45500014	285	45802-03	112, 189	46548-03	407				
		45500015	285	45813-03	189, 286, 445	46549-03	440				
		45500064	186	45815-03	112, 189, 286						



49037-05A	281	50039-10	587	50359-04	586	50600040	584	50832-07A	602	51313-07	41
49050-09A	440, 441	50051-09	593	50370-04	592	50600104	583	50836-07	279, 439	51322-08	435, 598
49053-04A	103	50056-10	587	50377-07A	278	50600140	25, 583	50855-09	282	51345-08	276, 598
49060-04	106	50113-10	588	50378-07B	435	50602-00A	278	50865-09	282	51353-06	149
49078-04A	280	50130-95A	594	50379-07B	436	50602-89B	278	50903-85T	602	51369-06	152
49080-03A	176	50131-95A	594	50396-05	590	50610-86T	108	50911-08A	24, 588	51375-06	149
49080-06A	176	50176-95	594	50399-07A	278	50614-91A	597	50915-90T	595	51376-09	585
49087-01	407	50177-95	594	50400-07A	278	50627-08	588	50916-90T	595	51387-06A	228
49102-86T	603	50178-09	595	50409-04	430	50631-04	435, 596	50932-08	277	51393-06A	227
49110-98	597	50187-96	593	50420-05	596	50634-05	590	50957-02B	283, 601	51397-06A	228
49117-77TB	597	50190-96	593	50451-09	277, 595	50683-04	598	50964-98	602	51400-08	276, 598
49128-82	597	50193-96	279, 439	50454-09	277	50688-04	598	50976-99A	589	51404-10	150
49140-05B	281	50194-96	279, 439	50459-06	278	50695-08A	588	50978-99A	24, 589	51444-04A	355
49144-86	603	50198-97B	437	50460-06	278	50700001	263, 470, 787	51011-01	589	51468-06A	232
49149-84A	597	50202-04	586	50462-11	103	50700002	263, 787	51017-01	589	51469-06A	231
49155-05B	440	50203-04	108	50500-03	594	50700005	177	51039-05	277	51470-06A	230
49155-09A	440	50210-06	182	50500025	587	50700007	177	51060-08	435, 598	51471-06	153
49171-08	270	50211-04	596	50500030	582	50700008	177	51072-09	366	51473-06A	150
49179-09	407	50227-01	179, 270	50500035	588	50700010	105	51074-10	18, 85, 154	51474-06A	150
49200-07A	280	50246-00	279, 439	50500041	438, 599	50700013	55	51076-10	237, 370	51477-06	240
49215-07	106	50250-04	103	50500042	436	50700020	104	51078-10	18, 85, 154, 237, 370	51496-10BNR	813
49223-08	270	50251-01	435	50500089	584	50700021	104	51080-10	721	51496-10BYM	813
49249-06	182	50269-09	585	50500090	584	50700026	105	51082-10	721	51496-10DHD	813
49254-99	24, 589	50270-02A	54	50500091	584	50700027	105	51092-04	362	51507-04	84
49258-00A	260	50295-02	591	50500093	584	50700028	105	51093-04A	361	51509-04	84
49261-00A	260	50300008	382	50500096	584	50704-04	592	51099-02	245	51513-02	87, 157
49267-01A	55	50300009	246	50500109	183, 282, 600	50710-04	592	51112-00B	233	51525-09A	355
49279-06	182	50300028	41	50500124	183, 282, 600	50713-04	592	51114-00	245	51526-09A	355
49282-09B	406	50300030	92, 162, 247	50500139	183, 282, 600	50716-04	183, 438, 599	51119-01A	41	51527-09A	357
49283-09	407	50300031	92, 162, 247	50500144	183, 282, 600	50743-04	721	51120-01A	41	51534-00	245
49287-11	106	50300036	164	50500158	276, 430	50745-10	721	51126-01A	41	51535-06A	150
49291-07	406	50300038	163	50500167	601	50752-04	183, 279, 438, 600	51130-10	721	51538-00	83
49312-10	24, 582	50300040	93	50500168	601	50753-10	585	51132-98	91, 161, 243	51538-04	83
49320-09	184	50300042	383	50500225	179, 276, 432	50760-10	585	51138-07	41	51540-01A	153
49322-04	108	50300044	381	50500244	583	50763-09	108, 182, 437, 603	51142-04A	41	51540-04	153
49349-07	182	50300054	381	50500245	583	50768-07	436	51144-02	245	51540-06	153
49360-08	260	50300058	381	50500247	178	50782-91	279, 439	51146-10	88	51542-01B	360
49388-09	55	50300066A	247	50500262	584	50789-99B	436	51157-04A	365	51544-01A	84
49440-10	281	50300071	19	50500270	108	50807-08	183, 279, 438, 599	51161-10	159	51546-04	82
49442-10	440	50300076	381	50500367	583	50810-08	183, 279, 438, 599	51162-06	41	51569-01	40
49500-92T	597	50300091	19	50500386	178	50827-07A	602	51168-10	157	51570-00A	233
49742-01A	55	50300097	380	50500441	583	50828-07A	602	51220-07	41	51579-05A	378
50000008	283	50300099	248	50535-09	585	50829-07A	601	51287-10	721	51583-01	40
50000023	431	50310-02	591	50541-03A	439, 721	50830-07A	601	51289-10	721	51587-05	244
50000032	179	50312-03	591	50549-08	588			51291-10	721	51600-09	40
50000091	283	50357-04	183, 438, 599	50576-05	590			51304-10	721	51607-09	40
50027-09	593	50358-04	586	50600037	584					51615-09A	360

# 890 PART#/PAGE# REFERENCE

51615-99C	360	51787-08	236	52000133	362	52300008	369	52300334	395	52619-08A	358
51617-99C	361	51800-09	797	52000134	359	52300013	243, 245	52300335	393	52626-04	90, 160, 242
51619-09A	797	51801-07	233	52000135	363	52300016	40	52300336	90, 160, 242	52627-09	376
51620-09A	797	51804-02	155, 238, 372	52000145	84	52300018	87, 157, 240	52300353	374	52631-07	88, 161, 244
51621-09	797	51813-09	232	52000147	154	52300020	87, 157, 240	52300354	374	52633-08A	363
51622-07	90, 160, 242	51841-06	232	52000148	229	52300022	87, 157, 240	52300359	393	52652-04	90, 160, 242
51626-09	797	51851-09	87, 157, 240	52000149	229	52300024	87, 157, 240	52300360	395	52655-84	87, 157
51630-06	361	51898-05A	236	52000150	229	52300038	243, 245	52300361	378	52657-04B	379
51630-09A	361	51902-09	227	52000152	357	52300040	88	52333-97E	367	52689-09	150
51631-09A	369	51922-09	235	52000168	17	52300042	159	52335-97A	367, 395	52706-07	87, 157, 240
51633-06A	379	51928-01	362	52000176	364	52300044	159	52347-97	91, 161, 243	52709-97C	379
51634-06A	395	51929-01	362	52000177	364	52300046	159	52348-97	91, 161, 243	52710-07	86
51635-06	393	51933-01	150	52000180	80, 148, 226	52300049	157	52359-06	151	52715-04A	278
51637-97	18, 155, 238, 370, 836	51933-06	150	52000183	360	52300050	157	52378-07	151	52723-06	376
51638-97	155, 238, 370, 836	51936-08	228	52004-25	227	52300065	158	52395-03B	394	52726-09	150
51639-97	238, 370, 836	51985-08	235	52006-47B	227	52300070	156	52400020	394	52729-08	244
51640-06	90, 160, 242	51998-08	235	52017-08	82	52300090	156	52400039	227	52735-85	87, 157, 240
51641-06	90, 160, 242	52000003A	364	52018-08	237	52300096	86	52400040	356	52737-94A	87, 157, 240
51676-97A	18, 85, 155, 238, 372	52000004A	364	52023-01A	40	52300103	91, 161, 237, 370	52400053	82	52748-02	40
51700-09	362	52000011	232, 234	52036-08	155	52300105	370	52400060	18, 85, 154, 229, 367	52754-04	87, 157, 240
51703-05	365	52000012	230	52038-08	237	52300110	156	52400066	234	52760-11	245
51718-06	363	52000014	226	52066-97C	356	52300116	86	52400073	371	52777-85A	87, 157
51726-05	360	52000015	153	52067-08A	356	52300140	789	52400074	371	52796-09	164
51727-05A	379	52000031A	227	52093-08A	360	52300141A	378	52400090	372	52806-94B	86
51732-10	160	52000034	81	52095-08A	356	52300146	377	52400091	372	52825-05	380
51734-10	82	52000048	39	52099-09A	359	52300147	377	52408-07A	378	52828-11	245
51736-07	84	52000049	39	52100016	80	52300239	241, 253	52412-79A	91, 161, 243	52849-04B	79
51737-07	83	52000051	81	52124-09	156	52300243	241, 253	52423-09A	368	52856-06	156
51738-07	83	52000057	356	52193-08	797	52300245	81	52442-04A	230	52859-04B	79
51739-07	84	52000062	81	52198-03	79	52300257	377	52447-96	371	52866-06	156
51744-07A	82	52000072	364	52200003	846	52300258	377	52501-09A	368	52872-01	98, 251
51745-09	797	52000075	364	52200004	846	52300281	19	52517-94	90, 160, 242	52877-08	157
51747-07	82	52000084	18, 85, 154, 229, 367	52225-89	227	52300283	19	52532-90	91, 161, 243	52877-10	157
51749-07	82	52000098	234	52246-08	797	52300285	19, 28	52540-09A	240	52886-98D	379
51750-07	83	52000099	231	52265-01A	356	52300293	90, 160, 242	52544-05A	358	52892-98B	394
51751-07	83	52000113	80, 148, 226	52269-08	227	52300295	395	52546-09A	368	52898-98A	393
51762-06	230	52000114	80, 148, 226	52270-08	236	52300298	393	52572-09A	369	52900-09A	369
51763-07	236	52000118	797	52274-94B	395	52300300	378	52583-09A	369	52909-02	87, 157
51764-06	232	52000119	797	52284-04	151	52300301	90, 160, 242	52587-09	369	52912-00	236
51770-09	362	52000120	797	52284-06	151	52300302	378	52589-09A	369	52914-09A	369
51778-07	39	52000121	797	52288-06	152	52300307	19	52591-09A	368	52915-07	236
51780-07	40	52000123	17	52292-00A	228	52300312	394	52593-09A	368	52916-04B	84
51781-07	39	52000124	17	52292-94B	228	52300314	394	52596-09A	368	52918-98B	356
51782-07	40, 150	52000128	360	52296-94B	82	52300317	394	52609-05	358	52920-98B	379
51783-07	40	52000131	358	52300001	239	52300319	393	52610-09	376	52923-04B	84
		52000132	359	52300003	239	52300324	380	52612-95	91, 161, 243	52924-98B	379
										52930-05	236



52933-97B	376	53000242	396	53000399DUG	807	53111-10DBN	806	53285-06	416	53767-98	413
52935-04	376	53000247	396	53000399DUH	807	53111-11DCE	806	53301-06	416	53797-09	158
52940-04B	79	53000252	400	53000399DUM	807	53111-11DGX	806	53302-07	416	53803-06	375
52941-04B	79	53000253	400	53000399DWC	807	53111-11DHA	806	53303-07	386	53804-06	375
52952-97	155, 238, 370, 836	53000291	386	53000399DWF	807	53111-12DJO	806	53315-09	41	53810-00B	239
52965-98	91, 161, 243	53000302	417	53000402BHT	807	53111-12DJS	806	53359-02	227	53815-00	239
52975-05	359	53000303	418	53000402BYM	807	53111-12DJZ	806	53370-95C	241	53820-00	241
52976-05	359	53000322	416	53000402DH	807	53111-12DKJ	806	53371-95B	241	53821-00A	241
52997-98	261, 779	53000323	416	53000402DJO	807	53111-12DKP	806	53373-02A	355	53822-00A	241
52998-98	261, 779	53000329	397	53000402DSR	807	53111-13DPR	806	53374-03	239	53824-00A	241
53000055CRP	806	53000330	399	53000402DST	807	53111-13DPV	806	53378-03A	239	53826-00B	413
53000055DGA	806	53000343	400	53000402DSW	807	53111-13DPZ	806	53407-06	240	53842-00C	469
53000055DKW	806	53000375BHY	807	53000402DSZ	807	53111-96DH	806	53432-02	39	53859-02A	241
53000055DKX	806	53000375BJN	807	53000402DTC	807	53116-05BPS	807	53472-09	382	53862-00	93, 163, 247
53000055DKY	806	53000375DJQ	807	53000402DTF	807	53116-97DH	807	53494-04	94	53870-01A	156
53000055DLA	806	53000375DSX	807	53000402DTG	807	53147-98C	392	53510-07	93, 163, 247	53878-03	413
53000055DLH	806	53000375DTD	807	53000402DUA	807	53149-10DCE	811	53511-06	164	53882-02B	158
53000055DLN	806	53000375DTE	807	53000402DUF	807	53149-11CRP	811	53512-07	94	53887-05	401
53000055DLN	806	53000375DTI	807	53000402DUG	807	53149-11CRP	811	53527-95B	158	53896-06	247
53000055DQW	806	53000375DTP	807	53000402DUH	807	53149-12BYM	811	53528-95B	88	53899-02	93, 163
53000055DRA	806	53000375DUB	807	53000402DUM	807	53149-12DDX	811	53529-04	88	53911-01	401
53000055DRB	806	53000375DWK	807	53000402DWC	807	53149-12DED	811	53531-95B	241	53913-04	86
53000055DRI	806	53000375DWY	807	53000402DWF	807	53149-12DJO	811	53532-02	88	53919-04A	469
53000063	396	53000375DXD	807	53000402DWH	807	53149-12DKO	811	53533-02B	158	53920-08	94
53000076CRP	806	53000377BHY	807	53000402DWJ	807	53149-13DHZ	811	53543-95A	156	53925-04	86
53000076DGA	806	53000377BJN	807	53000404	807	53149-13DLE	811	53544-04	88	53928-05	244
53000076DKW	806	53000377DJQ	807	53000405	807	53149-13DPR	811	53545-95	86	53929-06AV	98, 251
53000076DKX	806	53000377DSX	807	53000431	420	53149-13DPU	811	53548-02A	417	53929-06DH	98, 251
53000076DKY	806	53000377DTD	807	53000443DWJ	807	53149-13DPY	811	53549-95	239	53929-12BDK	98, 251
53000076DLA	806	53000377DTI	807	53000443DWV	807	53149-13DRL	811	53559-04A	250	53930-03B	241
53000076DLH	806	53000377DTP	807	53000459	385	53149-99	811	53566-09	382	53931-03A	241
53000076DLN	806	53000377DUB	807	53011-98	383	53149-99DH	811	53579-01	418	53932-03A	241
53000076DLN	806	53000377DWK	807	53015-05B	256	53209-09	250	53605-97	419, 788	53938-04	383
53000076DQW	806	53000377DWY	807	53020-06A	156	53246-09B	386	53612-08	248	53953-06	247
53000076DRA	806	53000377DXD	807	53050-10	96	53249-01B	417	53618-05	244	53959-06	241
53000076DRB	806	53000392	417	53051-09	365	53260-02	385	53621-98	419, 788	53961-06	158
53000076DRI	806	53000399BHT	807	53055-05A	250	53260-09A	385	53649-05	248	53963-09BHY	806
53000130	401	53000399BYM	807	53057-07A	392	53270-06BPS	807	53652-05	248	53963-09CWB	806
53000131	400	53000399DH	807	53061-00B	256	53270-06BPY	807	53655-04	98	53963-09CWX	806
53000195	401	53000399DJO	807	53066-00C	250	53270-06BXT	807	53665-87	396	53963-09CYT	806
53000217	400	53000399DSR	807	53070-00A	436	53270-06DH	807	53667-89A	397	53963-10CYS	806
53000218	400	53000399DST	807	53075-03	241, 251	53270-08CGS	807	53690-06A	99, 250, 392	53963-10DH	806
53000221	385	53000399DSW	807	53086-04	380	53270-08COZ	807	53692-96	241	53963-11DCE	806
53000225	385	53000399DSZ	807	53111-05BPY	806	53276-04	385	53702-04A	711	53963-11DGX	806
53000229	397	53000399DTC	807	53111-07CGS	806	53276-09A	385	53711-96A	93, 163	53963-11DHD	806
53000237	401	53000399DTF	807	53111-09BYM	806	53281-06	240	53718-04	93, 163, 247	53963-12DBX	806
53000238	402	53000399DUA	807	53111-09CYS	806	53282-06	240	53743-97	383	53963-12DJO	806
53000239	402	53000399DUF	807	53111-10DBJ	806						

# 892 PART#/PAGE# REFERENCE

53963-12DJP	806	54246-09A	374	54652-05	269	55869-10	587	56100083	24	56740-08	592
53963-12DJQ	806	54247-09	376	54676-09	175	55876-10	627	56100098	583	56741-04	592
53963-12DJS	806	54248-09	376	54704-07	102	55879-10	630	56100101	583	56746-08	588
53963-12DJT	806	54250-10	93	54733-04	102	55881-10	630	56102-99	623	56750-04B	581
53963-12DJU	806	54252-10	163	54754-09	102	55900008	52	56152-04B	632	56751-04	592
53963-12DKF	806	54256-10	240	54758-07	268	55900023	640	56165-03	640	56789-05	290
53963-12DKJ	806	54258-10	239	55035-11A	876	55900067	632	56166-08	632	56799-04	590
53963-12DKP	806	54263-10	247	55056-10	754	55914-98	637	56170-83TA	641	56802-06A	164
53963-13DKC	806	54268-10	241	55058-10	754	55954-00	633	56174-03C	581	56832-04C	631
53963-13DPR	806	54283-09	382	55060-10	752	55967-08	624	56176-08	637	56857-05	624
53963-13DPW	806	54290-11	92, 162, 246	55062-10	752	55975-08A	627	56178-92TA	641	56902-08	633
53963-13DPZ	806	54291-11	92, 162, 246	55064-10	747	55977-09	626	56180-08	633	56916-07	639
53964-06B	158	54292-11	246	55065-10	747	55985-10	627	56184-08	636	56926-05A	581
53965-06	247	54296-11	241	55066-11	751	55996-09	639	56196-03C	581	56926-08A	581
53968-06C	158	54298-11	249	55067-11	751	56000006	607	56196-08A	581	56929-10	639
53976-08	94	54331-04A	387	55069-11	751	56000029	466, 604	56223-98	640	56931-10	639
53979-07A	248	54332-04A	387	55070-11	746	56000039	609	56241-96	594	56940-09	625
53988-07	375	54333-04A	387	55071-11	746	56000042	609	56246-08	594	56942-10B	630
53994-11	239	54352-09	399, 717	55082-11	50	56000076	466, 604	56246-96A	594	56964-07	636
54000008	428	54360-05	392	55083-11	50	56000077	466, 604	56254-09	585	56981-07	51
54000016	115, 196	54373-10	80, 148, 226	55128-11	751	56000080	605	56257-09	585	57000063	346
54000017	115, 196	54376-10	226	55129-11	751	56000081	605	56263-08	594	57000307	423
54000033	429, 856	54377-10	226	55130-11	751	56000084	466, 605	56263-96A	594	57000387BHT	804
54000040	102	54380-11	231	55192-10	876	56021-04B	622	56266-09	640	57000387DH	804
54000041	269	54381-11	231	55193-10	876	56032-08	632	56267-09	639	57000387DJI	804
54000091	428	54382-11	359	55798-10A	614	56036-08	637	56269-09	639	57000387DJO	804
54001-04A	269	54383-11	358	55800032	622	56047-03C	581	56275-08	579, 593	57000387DKJ	804
54008-04	417	54384-11	152	55800035	626	56047-08A	581	56275-96B	579, 593	57000387DPU	804
54011-04	417	54385-11	83	55800050	625	56060-01	641	56298-03A	640	57000387DST	804
54014-05	418	54386-11	83	55800094	634	56063-82A	640	56405-08	588	57000387DSW	804
54049-10	162	54387-11	394	55800103	629	56066-82A	640	56443-00A	589	57000387DSZ	804
54051-08	250	54397-11	235	55800188	622	56075-07	628	56459-01A	590	57000387DTF	804
54055-10	162	54564-09	427	55800198	629	56079-93T	628	56459-08	590	57000387DUA	804
54072-10	80, 148, 226	54588-94	269	55800224	16	56100007	579	56486-01	641	57000387DUN	804
54074-10	80	54594-03	175	55800237	16	56100008	579	56512-02C	581	57000387DWC	804
54075-10	148	54596-94	268	55800252	629	56100009	579	56512-08A	581	57000387DWF	804
54097-10	158	54598-02	427	55800289	630	56100010	579	56518-02	591	57000387DWJ	804
54099-10	368	54599-02	427	55800290	630	56100015	579	56518-08	591	57000387DWV	804
54145-10	430	54614-05	427	55800345	628	56100027	580	56567-86B	641	57000388DH	804
54157-10	437	54619-08	175	55800379	634	56100028	584	56619-03B	581	57000388DJI	804
54171-11	401	54621-05	175, 268	55800386	632	56100029	584	56623-99	623	57000388DJO	804
54187-10	582	54625-06	175	55800388	632	56100030	580	56626-99	785	57000388DSW	804
54196-10	582	54628-06	427	55854-07	627	56100034	580	56658-00	597	57000388DSZ	804
54205-09A	374	54630-03A	429	55857-10B	630	56100036	579	56676-02	597	57000388DUN	804
54213-09A	383	54631-02B	429	55859-10B	631	56100047	580	56729-04	586	57000388DWV	804
54215-09	383	54635-09	429	55861-09	636	56100048	596	56729-08	586	57000389BHT	804
54234-10	283, 601	54651-05	269	55864-09	633	56100054	579	56740-04	592	57000389BYM	804



57000389DH	804	57100226	114	57200086DRS	811	57200087DWC	811	57400114	222	57767-00	337
57000389DJO	804	57100227	457	57200086DSR	811	57200087DWF	811	57400115	222	57768-00	337
57000389DSR	804	57100233	808	57200086DST	811	57200087DWJ	811	57400120	144	57799-00	155, 238
57000389DST	804	57100257BHT	350	57200086DSW	811	57200087DWV	811	57400128	52	57800-00	423
57000389DSW	804	57100257BYM	350	57200086DSZ	811	57200087DXK	811	57400143	224	57801-11	75
57000389DSZ	804	57100257DH	350	57200086DTC	811	57200087DXM	811	57400146A	338	57802-11	75
57000389DTC	804	57100257DJO	350	57200086DTF	811	57200087DXN	811	57400150	347	57804-07	343
57000389DTF	804	57100257DSR	350	57200086DUA	811	57200087DYA	811	57400159	216	57805-03A	421
57000389DUA	804	57100257DST	350	57200086DUD	811	57200087DYC	811	57400176	336	57837-00A	218
57000389DUM	804	57100257DSW	350	57200086DUM	811	57200087DYO	811	57400184	74	57838-08	75, 142
57000389DWC	804	57100257DSZ	350	57200086DUN	811	57203-07	784	57400192	16	57844-05	421
57000389DWF	804	57100257DTC	350	57200086DWC	811	57205-05	56	57400204	340	57846-01	423
57000389DWJ	804	57100257DTF	350	57200086DWF	811	57207-05A	785	57400205	340	57850-01	43
57000389DZM	801	57100257DUA	350	57200086DWJ	811	57211-05	38	57400206	340	57861-06	38
57000398	804	57100257DUM	350	57200086DWV	811	57213-06	38	57400213	341	57870-07	38
57000399	804	57100257DUN	350	57200086DXK	811	57216-07A	785	57400224	341	57892-11	421
57000400	804	57100257DWC	350	57200086DXM	811	57251-08	218	57400225	341	57957-98A	346
57000482BYM	805	57100257DWF	350	57200086DXN	811	57253-08	218	57400226	341	57965-97A	142, 218
57000482DH	805	57100257DWJ	350	57200086DYA	811	57260-08	74	57400227	341	57969-97A	218
57000482DST	805	57100257DWV	350	57200086DYC	811	57262-08	74	57400228	341	57975-99	224
57000482DSW	805	57100258	350, 351	57200086DYO	811	57300-06	142	57400229	341	57981-97	337
57000482DWC	805	57100270	352	57200087AV	811	57301-06	142, 218	57400243	341	57988-09	346
57000536DYP	801	57101-01	812	57200087BDK	811	57331-07	142, 218	57400270	344	57995-96	337
57000536DZM	801	57109-01	38	57200087BHT	811	57338-08	143	57400271	344	58002-09	349
57000510	346	57140-05	223	57200087BYM	811	57340-08	143	57400273	339	58022-07A	349
57000529	343	57141-05	223	57200087CZB	811	57357-07	338	57400274	339	58024-96A	74
57006-03	813	57160-05	220	57200087DEA	811	57400-06	353	57400279	345	58042-04BDK	812
57015-06	145	57164-10	340	57200087DH	811	57400006	77, 146, 847	57400280	346	58042-04DH	812
57016-06	145	57166-10A	344	57200087DJI	811	57400007	146, 220, 847	57400281	345	58042-08BDK	812
57039-03BDK	813	57177-05	38	57200087DJO	811	57400008	146, 847	57400299	347	58042-08DH	812
57039-03DH	813	57185-05	341	57200087DKJ	811	57400021	219	57411-08	353	58053-10	75
57039-08BDK	813	57199-05	143, 219	57200087DLO	811	57400022	219	57454-10	582	58063-04	75, 143
57039-08DH	813	57200086AV	811	57200087DPU	811	57400024	336	57457-10	582	58073-09	221
57040-01	812	57200086BDK	811	57200087DQI	811	57400025	76, 145	57466-10	51	58120-96A	343
57040-01DH	812	57200086BHT	811	57200087DQX	811	57400026	145	57474-11	635	58135-94	337
57040-08	812	57200086BYM	811	57200087DQZ	811	57400027	217	57478-11	263, 787	58146-07	352
57040-08DH	812	57200086CZB	811	57200087DRS	811	57400028	145, 217	57485-11	635	58156-08A	343
57061-09	222	57200086DEA	811	57200087DSR	811	57400053	76	57609-08	144	58158-08	76, 145
57070-97DH	77, 803	57200086DH	811	57200087DST	811	57400060	38	57610-09	38	58161-09	221
57070-98	77, 803	57200086DJI	811	57200087DSW	811	57400091	340	57682-10	75	58163-02	338
57100179	296	57200086DJO	811	57200087DSZ	811	57400092	340	57688-10	222	58164-96A	77, 142
57100180	296	57200086DKJ	811	57200087DTC	811	57400093	344	57701-08	221	58165-09	221
57100198	353	57200086DLO	811	57200087DTF	811	57400094	344	57702-08	221	58166-08A	343
57100210	349	57200086DPU	811	57200087DUA	811	57400110	222	57716-01	76, 144	58181-78	341
57100211	106	57200086DQI	811	57200087DUD	811	57400111	222	57740-05	343	58187-86	341
57100212	146, 184	57200086DQX	811	57200087DUM	811	57400112	222	57749-04	222	58187-96	341
57100213	224, 280	57200086DQZ	811	57200087DUN	811	57400113	222	57754-04	224	58189-98	785

# 894 PART#/PAGE# REFERENCE

58192-87A	74, 142	58468-10BHT	805	58683-89B	353	58854-12DGV	350	59336-09	719	60215-06	735
58194-94	337	58468-10DCE	805	58684-89B	353	58854-12DJO	350	59338-09	719	60236-09BEO	127, 815
58195-94	337	58468-10DCG	805	58687-89	353	58854-12DJS	350	59349-97	399	60236-09DH	127, 815
58204-98	341	58468-10DGX	805	58688-89A	353	58854-12DKJ	350	59366-97	293	60236-10BEO	127, 815
58207-04	341	58468-10DID	805	58691-04	224	58854-12DKM	350	59367-97	293	60236-10DH	127, 815
58221-04	337	58468-12DJI	805	58703-09	75, 143	58854-12DKO	350	59368-97	293	60277-07	735
58240-95	222	58468-12DJO	805	58706-09	75, 143	58854-12DLO	350	59369-97	293	60280-07	735
58243-95	222	58468-12DJS	805	58714-06	352	58854-13CPB	350	59380-05	719	60293-00	195
58248-96	348, 786	58468-12DKJ	805	58722-09BDK	805	58854-13DJI	350	59385-98	473	60300004	295
58262-05	464	58468-12DKO	805	58722-09DH	805	58854-13DME	350	59386-98	473	60300045	114
58275-95	222	58468-13DPR	805	58722-10DCE	805	58854-13DPR	350	59397-03DH	454, 814	60303-06	195
58277-95	224	58468-13DPY	805	58722-10DGX	805	58854-13DPU	350	59397-98	454, 814	60303-07	195
58278-95	222	58481-02	781	58722-12DJO	805	58854-13DRC	350	59429-04A	715	60316-00A	296
58283-04B	345	58508-09BDK	805	58722-12DJS	805	58854-13DRJ	350	59470-06A	715	60345-08A	296
58284-04B	345	58508-09BPS	805	58722-13DKJ	805	58861-04BDK	351	59473-09	197	60379-09	114
58297-94	785	58508-09BPY	805	58722-13DPU	805	58861-04DH	351	59500105BEO	475	60402-04	114
58298-87	785	58508-09BXT	805	58742-05	144, 219, 220, 709	58865-03	144, 220	59500122BEO	475	60408-09	471
58301-96	341	58508-09DH	805	58751-05	143, 219	58882-04BDK	812	59500245	475	60469-01A	48
58302-96	341	58519-07A	347	58753-01B	345	58882-04DH	812	59500246	475	60475-92A	195
58303-96	341	58520-79TC	338	58770-96	221	58900-11	348, 786	59545-04	715	60476-00A	296
58308-95	785	58568-98A	343	58771-96	221	58900085	454, 814	59582-02A	294, 453	60484-01B	48
58314-97	341	58593-97	812	58772-97	221	58904-03	784	59600012	451	60489-06A	195
58325-06	337	58601-04	75, 143	58772-97	221	58907-96B	218, 221	59600018	473	60490-08	295
58346-06	143	58602-04	75, 143	58779-05	220	58932-98	352	59600022	451	60491-02A	471
58347-06	143	58606-11CRP	811	58799-02	338	59002-98	293, 452	59651-01	293, 452	60514-07A	195
58348-06	143	58606-12BYM	811	58830-88DH	351	59005-98	453	59664-03	193, 294	60529-90A	547, 555
58350-96	142, 218	58606-12DDX	811	58854-05	350, 351	59013-02A	454, 814	59685-10	719	60543-86A	555
58360-09	143, 219	58606-12DED	811	58854-05AV	350	59027-99	307	59720-01A	735	60543-89	555
58361-03	144, 220, 700	58606-12DJO	811	58854-05BHT	350	59045-00B	454, 814	59726-04	57	60543-94	555
58376-09	143, 219	58606-12DKO	811	58854-05BPS	350	59052-98	293, 452	59776-10	719	60543-95	555
58387-06	143, 219	58606-13DHz	811	58854-05BPY	350	59054-96	814	59802-05	143, 219	60543-99B	554
58397-00	218	58606-13DLE	811	58854-05DH	350	59068-96	293, 452	59863-94T	736	60553-07A	554
58402-04	784	58606-13DPU	811	58854-06BXT	350	59069-96	293, 452	59899-88T	737	60572-86	547, 555
58413-06	143, 219	58606-13DPY	811	58854-07CGR	350	59071-98	307	59925-06	197, 815	60607-08	572
58433-96	337	58606-13DQX	811	58854-07CGS	350	59081-96	293, 452	59925-06DH	197, 815	60610-02A	295
58444-06	143, 219	58606-13DRJ	811	58854-08COZ	350	59133-99	342	59931-08	248	60639-00	556
58468-09BDK	805	58606-99	811	58854-08CPH	350	59141-98	736	59983-75T	736	60653-92T	543
58468-09BPY	805	58606-99DH	811	58854-09BYM	350	59146-96	294, 453	6000497DWC	808	60654-07A	296
58468-09CGR	805	58617-09	143	58854-09CWA	350	59147-96	294, 453	60041-04	737	60655-07A	296
58468-09CGS	805	58628-99	222	58854-09CYS	350	59209-91T	292, 452	60050-01	736	60665-85B	555
58468-09COZ	805	58630-09	143	58854-10DBJ	350	59213-96	342	60051-01	736	60665-89	555
58468-09CPC	805	58649-97A	223	58854-10DCE	350	59228-91	294, 453	60060-04	736	60665-99B	554
58468-09CWA	805	58651-97A	223	58854-10DEK	350	59230-88	307, 473	60065-03	736	60667-85A	555
58468-09CWL	805	58652-97A	223	58854-10DEM	350	59239-93	397	60179-06	294, 453	60668-84B	547
58468-09CWT	805	58653-97A	223	58854-11DGR	350	59285-90	293	60193-07	734	60668-99	547
58468-09CYS	805	58657-97A	224	58854-11DGX	350	59286-90	293	60197-08	296	60670-85A	547, 555
58468-09DH	805	58658-97A	224	58854-11DHA	350	59320-07	248	60210-07	734	60706-09A	553



60711-07	195	61100035	469	61400033	462	61769-47T	816	62600054	861	63023-05	125, 682
60713-07	547, 553	61100038	685	61400034	462	61771-66TB	816	62600055	861	63026-05	640
60713-99	547, 553	61200008	109, 675	61400035	462	61774-51T	816	62600056	861	63027-05	640
60715-99B	553	61286-92T	468	61400037	687	61775-59T	816	62600059	861	63030-09	566, 682
60717-07A	553	61300049	468	61400038	687	61776-61T	816	62600060	861	63055-09	566, 682
60739-01	556	61300050	468	61400058	411	61777-63T	816	62600061	861	63065-09	566, 682
60739-07	556	61300055	120, 538	61400074	791	61782-91T	816	62667-87TA	125, 682	63087-07	125
60747-01	556	61300056	538	61400085	542	61783-92T	816	62668-87TA	567, 682	63121-11A	455, 565
60751-01	556	61300057	538	61400086	543	61784-92T	816	62692-07	567	63133-10A	126, 687
60758-06A	553	61300058	538	61400087	544	61785-92T	816	62700005	566, 682	63134-10A	126, 687
60764-06A	554	61300109	490, 561	61400088	545	61814-55T	816	62700009	125, 682	63139-10A	126, 687
60766-06	547	61300110	490, 561	61400089	539	61840-94T	816	62700011	125, 682	63140-10A	126, 687
60782-06A	554	61300120	550	61400094	722	61929-98	100	62700015	853	63690-00A	562
60792-06C	556	61300128	550	61400141	722	62027-04	100	62700017A	564	63692-00A	562
60794-06C	556	61300138	290, 727	61400148	568	62028-04	155	62700045	872	63698-02	562
60800005	184	61300186	172	61400149	456, 726	62030-04	100	62700055	872	63709-04	562
60801-06	572	61300217	537	61400152A	722	62063-01	371	62700082	125	63729-04	562
60815-08A	556	61300218	539	61400153A	722	62378-10	468	62732-04DH	815	63731-99A	872
60825-11	542	61300219	542	61400154	722	62470-02	561	62732-07DH	815	63782-80	872
60826-11	539	61300221	544	61400155	722	62512-97	124	62778-10	685	63793-01K	872
60837-07	48	61300222	545	61400163	546	62600004	862	62803-97A	685	63794-10	853
60839-07	48	61300223	540	61400167	546	62600005	861	62809-06	562	63795-10	852
60845-11	544	61300224	538	61400176	123	62600007	861	62811-08C	686	63796-77A	872
60849-10	556	61300227	22	61400193	465	62600008	861	62816-03	687	63797-10	853
60867-08	295	61300254	541	61400194	465	62600009	861	62818-06F	686	63798-99A	872
60868-10	556	61300275	342	61400197	465	62600010	862	62819-03	687	63799-10	853
60869-10	556	61300299	489, 550	61400199	460	62600011	861	62823-06C	686	63805-80A	872
60870-10	556	61300310	342	61400200	460	62600013	861	62823-08C	686	63806-00Y	872
60876-11A	552	61300358	342	61400201	460	62600014	861	62858-99	567	63810-80A	872
60885-10	556	61300364	28	61400205	791	62600015	861	62896-00B	567, 682	63812-90	872
60886-11A	552	61300452	733	61400206	791	62600017	861	62910-06C	686	63813-90	872
60938-10	197	61300516	485, 549	61400210	465	62600018	861	62910-09C	686	63834-07	872
60947-10	127	61300517	485, 549	61400224	342	62600019	862	62920-00A	455	64100-03	787
60949-10	735	61307-10	469	61400225	455, 562	62600021	861	62938-00E	567	64101-03	787
60969-10	735	61308-09	468	61400255	456, 726	62600023	861	62946-09	566, 682	64108-03	618
60972-10	127	61319-09	468	61400260	461	62600024	861	62955-09	566, 682	64115-04	619
60978-10	197	61335-09	468	61400269	23	62600025	862	62962-01A	45	64120-06	787
61000157DYE	29	61359-98	468	61400292	727	62600026	862	62965-01	306	64216-09	262
61100006A	687	61374-04	468	61400293	727	62600027	862	62968-02	563	64227-08	262
61100007A	687	61400001	464	61400294	727	62600030	861	62974-09	566, 682	64230-08	262
61100008	688	61400002	559	61400295	727	62600031	861	62982-03B	45	64601-10	495
61100009	469	61400007	537	61653-04	109	62600033	862	62995-04	455, 565	64800022	503
61100018	688	61400022	545	61655-91	171	62600038	861	62999-04	815	64806-07A	495, 499
61100024	685	61400023	543	61740-90T	816	62600041	861	62999-07	815	64900091	504
61100032	688	61400024	545	61741-93T	816	62600042	861	63002-09	566, 682	64900093	504
61100033	469	61400025	543	61742-93T	816	62600043	861	63004-09	566, 682	64900124	497
61100034	688	61400028	349	61769-40T	816	62600053	861	63020-04	562	64900127	499

# 896 PART#/PAGE# REFERENCE

64900128	495	65989-90B	868	66530-03	558	67700216	725	67800459	714	68000116	381, 382
64900129	499	65989-97C	868	66532-07	558	67700241	694	67800483	711	68000118	705
64900137	498	65991-82B	868	66543-08	558	67700242	694	67800484	711	68000119	719
64900186	507	66000004	854	66545-07	558	67700243	694	67871-85TA	112	68000123A	713
64900187	507	66000005	856	66718-01	124, 173	67700244	694	67884-90TA	112	68000128	473
64900208	493	66000033	855	66906-10	509	67701-09	720	67890-91C	291	68000129	473
64900209	493	66000034	855	67074-02	705	67704-03	56, 698	67891-99	291	68000141	704
64900220	29	66000038	854	67182-04	678	67734-88T	728	67900007	734	68000142	704
64900242	498	66000041	855	67182-07	678	67735-91T	729	67900008	734	68000151	387
64900243	498	66000042	855	67187-04	171	67737-88T	728	67900056	734	68000152	387
64924-09	495	66000043	855	67188-04	171	67738-91T	729	67900057	734	68000153	387
64937-00A	262	66000044	855	67189-95	171	67750-88T	728	67900058	734	68000170	704
64938-00	262	66000046	855	67206-04	677	67751-91T	729	67900059	734	68000171	704
64981-09	509	66000107	45, 567, 682, 848	67231-04A	677	67752-77T	728	67900127	254	68000172	694
65000-04	48	66006-29F	868	67268-06B	677	67761-96	728	67900130	165	68000173	694
65100013	506	66006-70	868	67293-95	678	67774-10	719	67907-96C	290, 727	68006-83T	729
65100014	506	66007-84	868	67294-95A	678	67775-01C	697	67913-95T	729	68011-88T	729
65100015	508	66010-82B	868	67313-05A	676	67783-78T	728	67931-11	398, 717	68011-91T	729
65100016	508	66010-97C	868	67315-05A	676	67791-91T	729	67932-11	398, 717	68012-88E	398, 717
65100017	508	66021-00	289	67516-04B	680	67796-91T	729	68000005	246	68055-10BHP	291
65100018	508	66050-03	457	67516-08	680	67800055	707	68000006	246	68065-10	381, 382
65100019	508	66053-01	289	67522-04B	680	67800056	707	68000026	701	68085-08	714
65100028	508	66088-96	557	67524-04	677	67800060	707	68000029	719	68086-08	714
65100029	506	66192-99	173	67593-05	705	67800061	707	68000035	349, 723	68087-08	714
65100035	506	66261-04	124	67610-09	720	67800065	254	68000042	703	68116-08	714
65100048	493	66262-04	124	67620-09	720	67800071	95	68000043	703	68117-08	714
65100049	493	66264-04	124	67671-09	720	67800133	714	68000051	701	68118-08	714
65100054	508	66310-02	43	67678-09	720	67800134	714	68000069	701	68127-10	706
65100056	28	66328-82T	124	67679-09	720	67800135	714	68000075	696	68128-10	706
65115-10	506	66331-05	43	67680-09	720	67800166	703	68000076	92, 162, 246, 377	68129-97	77, 803
65247-09	499	66340-78	124, 173	67695-09	720	67800167	708	68000077	92, 162, 246, 377	68129-98DH	77, 803
65271-03	48	66358-83	124, 173	67700032	697	67800241	414, 716	68000082	414, 718	68143-98A	712
65400001	502	66367-97	124	67700033	697	67800242	414, 716	68000083	414, 718	68150-05	677
65400064	509	66368-97	173	67700059	695	67800355	714	68000090	704	68160-99	402
65400078	495, 499	66375-06	173	67700078	699	67800356	714	68000092	704	68172-06	398, 717
65400079	495, 499	66375-97	173	67700093B	695	67800357	714	68000104	349, 723	68185-00	710
65400082	502	66378-06	850	67700109	695	67800358	714	68000105	127, 715	68189-07	733
65400088	499	66426-04	172	67700112	695	67800358	714	68000106	715	68192-99	402
65400117	509	66439-07	173	67700115	726	67800366	703	68000107	715	68200-00D	849
65400137	495	66440-05	290	67700116	56, 726	67800367	703	68000110	700	68200-07A	849
65400143	495	66441-05	291	67700117	456, 726	67800368	398, 717	68000111	381, 382	68207-00D	849
65400167	28	66442-06	173	67700118	699	67800374	706	68000112	396	68207-07A	849
65400172	499	66443-06	173	67700139	699	67800375	706	68000113	396	68208-98A	705
65430-10	506	66446-07	172	67700144	16, 695	67800448	414, 716	68000114	410	68211-05	56
65600155	495	66477-10	560	67700145	16, 695	67800449	414, 716	68000115	410	68219-10	381, 382
65948-00A	868	66516-07	558	67700173	696	67800450	414, 716	68000116	410	68227-09	158, 165
65958-04A	868			67700189	696	67800451	414, 716			68250-08A	396
				67700215	724	67800457	714				



68266-03	710	68952-98	710	69229-04	703	69749-05	725	70900038	678	71370-05	819
68271-08A	396	68961-98A	677	69230-04	703	69752-04	730	70900070A	675	71400105	425, 731
68273-03A	705	68971-98B	803	69234-04	703	69753-04	730	70900071A	675	71400106	425, 731
68286-10	410, 411	69000007	126, 732	69235-04	703	69754-04	730	70900072A	675	71500110	612
68297-05	697	69000009	126, 732	69236-04	56	69755-04	730	70900078	678	71500177	611
68311-01	729	69000038	835	69284-05	700	69756-05	730	70900100C	109, 675	71500178	611
68317-06A	849	69000058	185	69285-05A	700	69757-05	730	70900103	170, 264	71500179	611
68328-06A	849	69015-08	564	69286-05B	702	69758-05	730	70900171A	675	71500180	611
68332-08	729	69036-88A	733	69287-07	701	69759-05	730	70900176	680, 681	71500185	611
68335-05	697	69039-09A	733	69289-05	702	69760-05	730	70900183	676	71500248	612
68341-05	697	69060-90H	732	69290-09	723	69761-05	730	70900193	680, 681	71500250	612
68342-05	697	69063-03A	708	69303-02	57, 707	69787-07	729	70900264	684	71500285	611
68344-05	697	69112-95E	126, 732	69304-02	57, 707	69790-07	729	70900265	684	71500286	611
68345-05	697	69147-03A	708	69306-02	707	69791-07	728	70900274	109, 675	71514-98	126
68348-05	705	69153-03A	708	69307-02	706	69792-07	728	70900283	681	71527-04	126
68352-06B	849	69166-01A	733	69308-02	706	69793-07	728	70900284	681	71656-07	612
68358-07A	719	69167-02A	733	69309-10	849	69794-07	728	70900293A	680	71718-02	613
68388-10	410, 411	69200033	661	69366-07	57	69795-07	728	70900294	680	71790-05	470
68411-10	706	69200042A	713	69367-07	57	69797-08	698	70900295	680	71802-03	612
68412-99A	701	69200091	100, 169, 261, 424, 672	69368-11	92	69802-08	698	70900296	680	71803-03	612
68413-99A	701	69200106	661	69374-05A	57	69817-07A	715	70900297	680	71804-03	53, 612
68435-10	706	69200181	386	69426-04	677	69818-06	703	70900307	683	71808-03	612
68478-05	57	69200289	387	69433-08A	143, 146, 709	69820-06	710	70900308	683	71813-09	611
68510-74C	712	69200357	100, 169, 261, 424, 672	69461-06D	713	69828-06	677	70900354	684	71816-09	612
68517-94A	77, 709	69200441	699	69462-06D	713	69829-06	677	70900463	467	71826-11	611
68544-10	165	69200442	699	69463-06B	713	69851-06	698	70900465	468	71872-11	612
68546-09	715	69200442	699	69465-06	713	69857-07	252	70900474	468	71902-08	819
68564-06	709	69200602	722	69492-05	708	69929-07	252	70900475	109, 675	71903-08	819
68593-06	698	69200605	424	69494-06	399, 717	70032-09	386	70900501	467	71973-08	819
68595-06	698	69200722	425, 673, 731	69577-06A	708	70113-08	386	70928-07	819	72673-11	673, 731
68603-01	144, 700	69200765	713	69604-03A	726	70169-06A	661	71031-04	847	73279-10	95
68605-08A	700	69200772	377	69611-06	698	70172-06	661	71038-04	847	73294-10	291
68611-98	712	69200826	424, 672	69622-99B	724	70213-02C	613	71039-04	847	73342-09	730
68615-04	711	69200850	722	69623-99A	724	70222-96B	53, 611	71040-04	847	73343-09	730
68617-04	711	69200850	722	69624-99A	724	70223-96B	611	71041-04	847	73344-09	730
68643-09	77, 709	69200863	704	69626-99	724	70228-96C	611	71149-05	819	73369-10	252
68669-05A	702	69200864	704	69627-99	724	70239-07	616	71172-05	819	73415-11	162, 246
68670-05A	702	69200865	646	69709-00A	112	70248-02B	613	71202-03	266	73416-11	715
68682-09	409, 718	69200897	694, 696	69710-06	197, 815	70255-02B	613	71208-07	266	73420-11	127, 715
68718-02	165	69200907	647	69732-05	725	70264-94A	425, 673, 731	71229-05	819	74439-00	678
68732-02A	165	69200921	731	69733-05	725	70270-04	425, 673, 731	71237-05	819	74497-03	43
68733-02A	165	69201099	424, 672	69734-05	725	70623-06	521	71282-04	171	74537-93A	306, 455
68775-93TA	728	69201108	704	69735-05	725	70623-08	521	71283-01	266	74538-09	455
68913-98C	705	69201109	704	69736-02	730	70623-11	521	71284-01	171	74541-00	463, 681
68926-00	848	69208-09	707	69738-05	725	70641-08	377	71288-03A	467	74543-00	455
68926-07	848	69227-04A	703	69739-01	730	70683-08	92	71296-07	266	74548-10	470, 681
68927-00	848	69228-04	703	69740-01	724	70900001A	676	71337-05	819	74550-92T	463

# 898 PART#/PAGE# REFERENCE

74552-04A	680	75031-09	109	76000192A	668	76000497DYC	808	79071-09CGR	806	80680-12	501
74553-04A	680	75041-03	683	76000193	21, 263, 669, 781	76000497DYO	808	79071-09CPC	806	80681-12	501
74554-04	680	75042-03	683	76000202	659	76000505	649	79071-10BHT	806	8071	574
74560-96	463	75051-08A	684	76000232	646	76000511	646	79071-10BYM	806	80716-08	507
74562-98	463	75054-03	681	76000238	655	76000512	646	79071-10DBJ	806	8072	574
74567-11	306	75055-03	681	76000256	657	76000513	664	79071-10DEK	806	80721-09	505
74577-97	172	75084-04C	684	76000257	657	76000522	461	79175-10BDK	391	80726-09A	494
74578-97	306	75095-05B	684	76000259	671	76000523	647	79175-10BPY	391	8073	574
74579-97	126	75097-05	685	76000263	656	76000539	352	79175-10BYM	391	8074	574
74582-00	306	75098-08A	684	76000266	664	76000548	649	79175-10CGS	391	80742-09A	505
74584-99	465	75102-04	683	76000275	659	76000582	665	79175-10CYS	391	80781-12	501
74596-00	463	75104-04	683	76000278	647	76000587	648	79175-10DGX	391	80794-10A	496
74597-01	306	75108-06	683	76000280	647	76208-07	665	79175-10DH	391	80812-10	507
74604-99	465	75110-98B	851	76000307	461	76251-98A	664	79175-12DGV	391	80813-12	500
74609-04	126	75113-04A	680	76000308	386, 665	76262-08A	663	79175-12DJO	391	80817-10A	502
74610-01	306	75113-08	680	76000308	386, 665	76312-98	671	79175-12DJS	391	80818-10	502
74610-08	306	75115-06	683	76000317	649	76320-08A	663	79175-12DKJ	391	80821-10	499
74612-06	464	75133-99	679	76000318	649	76321-09A	662	79175-13DPU	391	80829-10A	502
74616-04	172, 306	75137-98B	851	76000351	646	76326-00A	665	79179-08	396	80846-10	504
74622-04	455	75138-09	679	76000390	661	76386-08	664	79189-06	392	80847-10	505
74622-06	455	75158-10	851	76000410	648	76386-09A	664	79192-10	391	80871-10	194
74622-09	455	75176-08	685	76000411	648	76388-08	664	79211-08A	400	80872-12	498
74661-04	470, 681	75237-03C	684	76000486	646	76390-05A	669	79300-06D	167	80881-10A	504
74662-04	470, 681	75242-08A	684	76000487	650	76400-09	664	80102-97	494	80887-10	495
74665-04	172	75327-09C	686	76000489	650	76404-06	655	80104-99	498	83324-09A	881
74667-06	172	75338-09	109	76000497AV	808	76410-09	664	80366-99	498	83527-10DH	805
74682-10	680	75340-09	679	76000497BHT	808	76412-06	654	80412-04	494	83527-12DJO	805
74683-10	680	75343-10	685	76000497BYM	808	76440-06	661	80415-04	494	83527-12DJS	805
74688-10	680	75357-10A	684	76000497DH	808	76476-10	655	80416-06	494	83527-13DPY	805
74689-10	680	75358-10A	684	76000497DJI	808	76556-09	665	80417-06	494	83665-11A	881
74690-10	680	76000013	658	76000497DJO	808	76561-09	665	80503-07	494	83812-09	472
74691-10	680	76000014A	667	76000497DKJ	808	76569-09	670	8060	574	83819-09	442
74692-10	680	76000021	658	76000497DLO	808	76572-09	670	80601-09A	497	83825-09B	472
74717-10	676	76000024A	668	76000497DPU	808	77028-10	657	8061	574	83841-09	471
74720-10	676	76000050	658	76000497DSR	808	77037-10	657	80611-09	508	83843-09	472
74723-10	676	76000051	656	76000497DST	808	77107-09	660	8062	574	83911-09B	873
74736-10	462, 681	76000061	263, 669, 781	76000497DSW	808	77108-09A	660	80621-12	501	83946-11	387
74737-10	462, 681	76000068	654	76000497DSZ	808	77117-10	671	80629-10	506	83968-10	421
74774-11B	675	76000070	654	76000497DTC	808	77126-98	671	8063	574	83976-10	421
74775-11A	675	76000074	656	76000497DTF	808	77140-05	467	80630-10	506	83989-10A	423
74776-11A	675	76000143	655	76000497DUA	808	77142-06	464	8064	574	84023-11	473
74777-11A	675	76000145	670	76000497DUM	808	77143-07	464	8065	574	84028-11	473
75008-02A	851	76000155	662	76000497DUN	808	77173-08	661	8066	574	84031-11	403
75012-82D	679	76000156	465	76000497DWF	808	77181-10	657	8067	574	88200-09A	166
75014-06C	686	76000157	465	76000497DWJ	808	77196-08	616	80674-08A	497	88232-06	418
75020-08C	686	76000169	654	76000497DWV	808	77197-08	616	80678-08	496	88237-07	252
75027-08C	686	76000191A	668	76000497DYA	808	79071-09BPY	806	80679-12	500	88238-07	252



88263-07	257	90200615CRP	808	90200826DSW	808	90200872DKJ	809	90201078BHT	810	90251-09	409
88272-06	790	90200615CYS	808	90200826DSZ	808	90200872DPU	809	90201078BYM	810	90255-09	409
88286-07	257	90200615DCE	808	90200826DTC	808	90200872DST	809	90201078DH	810	90300003	100, 169, 260
88299-09	410	90200615DGM	808	90200826DTF	808	90200872DSW	809	90201078DJO	810	90300010	255
88306-07A	253	90200615DGX	808	90200826DUA	808	90200872DSZ	809	90201078DST	810	90300017	100, 169, 260
88312-07A	97	90200615DH	808	90200826DUM	808	90200872DTC	809	90201078DSW	810	90300086	89, 159, 249, 375, 847
88348-10	166	90200615DJO	808	90200826DUN	808	90200872DTF	809	90201078DST	810	90300087	89, 159, 249, 375, 847
88358-10	95	90200615DJS	808	90200826DWC	808	90200872DUA	809	90201078DUM	810	90300096	469
88373-10A	255	90200615DKJ	808	90200826DWF	808	90200872DUN	809	90201078DWC	810	90313-08	258
88390-10	95	90200615DPR	808	90200826DWJ	808	90200872DWC	809	90201079	403	90320-00D	258
90067-06	392	90200615DPU	808	90200826DWV	808	90200872DWF	809	90201084	412	90330-08	96
90126-00A	168	90200616A	252	90200826DXK	808	90200872DWJ	809	90201088DBN	810	90342-04A	96
90126-00DH	168	90200641	255	90200826DXM	808	90200872DWV	809	90201088DBX	810	90363-08	94
90133-06B	257	90200666	407	90200826DXN	808	90200873	809	90201088DSV	810	90369-06D	167
90181-08A	165	90200669	255	90200827AV	808	90200874AV	809	90201088DSY	810	90395-00	710
90200353B	254	90200670	255	90200827BHT	808	90200874BHT	809	90201088DTB	810	90419-08	256
90200389	254	90200678	254	90200827BYM	808	90200874DH	809	90201088DTE	810	90465-98A	88
90200390	254	90200719	780	90200827CZB	808	90200874DJI	809	90201088DTH	810	90531-93	409, 718
90200391	410	90200721	780	90200827DH	808	90200874DJO	809	90201088DTR	810	90564-06D	167
90200417	259, 782	90200735	402	90200827DJI	808	90200874DKJ	809	90201088DWM	810	90570-86TA	97, 168, 259
90200421	412	90200736	402	90200827DJO	808	90200874DPU	809	90201088DWP	810	90589-91D	169
90200456	259, 782	90200737	410	90200827DKJ	808	90200874DST	809	90201088DZC	810	9058A	518
90200493	42	90200740	411	90200827DPU	808	90200874DSZ	809	90201093BHJ	810	90645-03A	412
90200561	408	90200741	411	90200827DQX	808	90200874DSZ	809	90201093BJN	810	90690-04A	413
90200570	168, 782	90200742	411	90200827DQZ	808	90200874DTC	809	90201093DJQ	810	90715-08BDK	251
90200571	168, 782	90200765	253	90200827DRS	808	90200874DST	809	90201093DSX	810	90715-08DH	251
90200572	99, 782	90200787	406	90200827DSR	808	90200874DTF	809	90201093DTD	810	90725-08BDK	251
90200573	99, 782	90200788	406	90200827DST	808	90200874DUA	809	90201093DTH	810	90725-08DH	251
90200612	808	90200791	407	90200827DST	808	90200874DUN	809	90201093DTI	810	90799-94D	97
90200613	808	90200792	410	90200827DSW	808	90200874DWC	809	90201093DTP	810	90839-94A	408
90200614BPY	808	90200793	410	90200827DTC	808	90200874DWC	809	90201093DUB	810	90853-06DH	413
90200614BYM	808	90200816	253	90200827DTC	808	90200874DWF	809	90201093DWC	810	90857-06DH	413
90200614CGS	808	90200821	413	90200827DTF	808	90200874DWJ	809	90201093DWM	810	90876-05	259
90200614CRP	808	90200826AV	808	90200827DTF	808	90200874DWV	809	90201093DWN	810	90881-09A	406
90200614CYS	808	90200826BHT	808	90200827DUA	808	90200875	809	90201093DWP	810	90892-09	408
90200614DCE	808	90200826BYM	808	90200827DUM	808	90200882	418	90201093DZC	810	90999-09	403
90200614DGM	808	90200826CZB	808	90200827DUN	808	90200906	20	90201107	810	91001-01	170, 264
90200614DGX	808	90200826DH	808	90200827DWC	808	90200914	412	90201108	808	91008-82C	97, 168, 259
90200614DH	808	90200826DJI	808	90200827DWF	808	90200915	412	90201109	808	91017-10	169
90200614DJO	808	90200826DJO	808	90200827DWJ	808	90200918	416	90201112	809	91026-94A	265
90200614DJS	808	90200826DKJ	808	90200827DWV	808	90200951	411	90201113	809	91051-94	783
90200614DKJ	808	90200826DKJ	808	90200827DXK	808	90200954	411	90201118	808	91066-07	719
90200614DPR	808	90200826DPU	808	90200827DXM	808	90200957	411	90201119	808	91067-07	719
90200614DPU	808	90200826DQX	808	90200827DXN	808	90200981	406	90201122	809	91080-93	292
90200615BPY	808	90200826DQZ	808	90200872AV	809	90200991	420, 789	90201123	809	91085-83D	451
90200615BYM	808	90200826DRS	808	90200872BHT	809	90200992	421	90214-05	409		
90200615CGS	808	90200826DSR	808	90200872DH	809	90201044	185	90233-08	258		
		90200826DST	808	90200872DJI	809	90201052	412	90238-00	260		
				90200872DJO	809			90240-08	258		

# 900 PART#/PAGE# REFERENCE

91099-94A	451	91569-01	837	91772-85A	783	92003-10BPY	810	92200118DYR	801	93100027	833
91100-09	451	91573-06	441	91773-85	783	92003-10BYM	810	92200123DYV	801	93100028	835
91100-94	451	91573-09A	441	91777-02	407	92003-10DCE	810	92200125DYR	801	93100032	839
91117-97	292, 453	91583-99	372	91783-96	419, 788	92003-10DGX	810	92200126DYR	801	93100034	837
91124-03A	616	91600001	862	91790-84C	260	92003-10DHF	810	92200127DYV	801	93100035	837
91134-01	264	91614-09CWA	809	91800029	450, 771	92003-12DJO	810	92238-09	668	93300001	418
91135-09	170, 264	91614-09DHF	809	91800030	289	92003-12DJS	810	92352-08	263, 782	93300003	775
91136-07A	42	91614-10BEO	809	91810-85	817	92003-12DKJ	810	92398-09	25, 606	93300004	775
91143-06BEO	413	91614-10DCE	809	91811-85	817	92003-12DKO	810	92410-09	606	93300005	776
91147-02	618	91614-10DID	809	91815-85	817	92003-13DPR	810	92416-08	25, 606	93300006	777
91172-09	42	91614-12DJO	809	91816-85	817	92003-13DPU	810	92423-08A	25, 607	93300007	21, 778
91177-97	265	91614-12DJS	809	91820-85A	142, 218	92022-03A	609	92441-10	25, 606	93300008	776
91179-10	408	91614-12DKJ	809	91838-92	262	92023-03A	609	92468-10	540, 818	93300009	777
91194-04	193, 292	91614-12DKO	809	91840-03B	609	92059-07A	605	92469-10	540, 818	93300010	778
91195-04	292, 452	91614-13DPR	809	91843-97	424, 672	92068-08A	605	92500011	514	93300014	778
91216-97	408	91614-13DPU	809	91845-03B	609	92085-10	466, 604	92500019	514	93300015	778
91219-98	415	91614-13DPY	809	91846-03B	609	92096-05	606	92500020	515	93300017	21, 776
91220-98	415	91615-09A	166	91848-03B	609	92115-09A	667	92500025	532	93300040	94, 778
91249-04	618	91621-07	265	91857-91	790	92136-05	415	92500026	532	93300044	99, 169, 783
91265-98A	408	91643-09	264	91861-93T	608	92137-05	415	92500027	532	93300045	99, 169, 783
91274-04	619	91657-02	606	91864-90T	608	92189-06	416	92600-10	466, 605	93300054A	348, 786
91286-10	408	91660-06	850	91866-90T	608	92190-06	607	92900001	841	93300055	785
91315-04	607	91668-05	372	91871-93T	608	92200068DYR	801	92900002	841	93300060	415
91333-06	563	91670-09	809	91875-70B	608	92200068DYV	801	92900004	840	93300061	415
91346-00	199	91671-10	424, 672	91877-97	790	92200069DYR	801	92900014	27	93300062	415
91347-00	301, 765	91672-07	850	91879-67B	608	92200069DYV	801	92900042	841	93300063	415
91357-99A	451	91684-08A	849	91885-97A	42, 419, 788	92200070DYR	801	92900043	841	93300069A	21, 777
91358-99A	451	91696-05A	607	91887-98	419, 788	92200070DYV	801	92900045	841	93300070	419, 788
91360-03	618	91697-06A	606	91907-87	609	92200073DXW	807	93023-88	790	93300071	419, 788
91364-03	619	91716-02	817	91909-03B	609	92200073DXX	807	93024-88	790	93300072	419, 788
91369-03	619	91718-02	817	91909-90A	608	92200073DXY	807	93025-88	790	93300092	420, 779
91402-00	292	91720-02	817	91910-03B	609	92200073DXZ	807	93036-95	790	93300093	20
91407-00	170, 265	91722-04	790	91910-90A	608	92200073DYR	801	93037-09	790	93500006	289, 457
91408-00	170, 265	91723-02	817	91924-09	466, 604	92200073DYV	801	93100002	839	93500011	457
91409-00	170, 265	91732-02	817	91930-92T	608	92200074DXW	807	93100005	839	93511-10	850
91412-04AV	98	91733-85A	199, 301	91931-92T	608	92200074DXX	807	93100015	839	93600001	825
91412-04BDK	98	91741-09DHF	809	91939-98	608	92200074DXY	807	93100016	839	93600002	826
91412-04DH	98	91741-10BEO	809	91940-98	608	92200074DXZ	807	93100017	843	93600004	491, 871
91422-09	809	91741-12DJS	809	91945-98B	466, 604	92200099DYE	29	93100018	834	93600005	863
91432-07	42	91741-12DKJ	809	91959-97	100, 169, 260, 788	92200101DYV	801	93100019	834	93600007	831
91440-06	42	91741-13DPY	809	91965-98	608	92200103DYV	801	93100020	834	93600010	825
91469-06	170, 265	91743-87T	783	91968-98	608	92200104DYV	801	93100021	834	93600011	824
91486-01	100, 169	91744-87T	783	91971-98	608	92200107DYR	801	93100022	833	93600012	824
91537-00C	258	91745-02	817	91982-03B	609	92200109DYR	801	93100023	833	93600013	824
91558-01B	837	91746-03	116	91983-03B	609	92200110DYR	801	93100024	833	93600016	828
91561-01B	837	91758-07	265	92003-10BDK	810	92200113DYR	801	93100025	833	93600022	824
91562-01	837	91771-04	671			92200117DYR	801	93100026	833	93600023	824



93600024	825	94059-03	572	94529-95	571	94755-99	470	97401-10	826	99668-04	689
93600025	826	94068-03	572	94531-95	571	94759-99	865	97410-10	853	99669-04	688
93600026	827	94109-95	737	94546-05	737	94760-99	828	98169-88T	789	99670-04	688
93600028	826	94111-95	77, 146, 224, 574	94560-07	305	94773-00A	199, 301, 771	98170-88T	789	99671-97	865
93600029	824	94112-04	41	94561-07	305	94773-07	199, 301, 771	98184-90T	789	99673-10	689
93600031	825	94114-02	737	94562-07	305	94778-10	831	98185-90T	789	99679-98	191, 304, 449
93600032	825	94115-93T	574	94564-98	864	94791-01	829	98186-84T	843	99686-98	689
93600033	826	94116-93T	574	94616-98	791	94792-08	261, 779	98187-90T	843	99688-10	689
93600034	827	94117-93T	574	94624-97B	856	94793-01	859	98192-85T	843	99690-10	688
93600056	830	94118-93T	574	94625-98	791	94811-10	828	98193-85T	843	99811-97	865
93600057A	830	94119-93T	574	94626-98	791	94819-02	858	98196-85T	789	99814-09	854
93600062	826	94120-93T	574	94630-98	571	94820-02	858	98197-85T	789	99816-09	854
93600064	825	94121-93T	574	94631-98	571	94821-01	859	98198-85T	789	99818-97	866
93600067	827	94122-93T	574	94640-08	836	94830-02	571	98199-85T	789	99819-09	854
93600068	826	94123-93T	574	94641-08	836	94832-02	571	98600BF	867	99820-09	854
93600069	825	94124-93T	574	94642-08	836	94834-02	571	98600BY	867	99821-09	856
93600071	824	94125-93T	574	94643-08	836	94844-10	829	98600EK	867	99822-02	863
93600073	826	94126-93T	574	94645-08	836	94845-10	859	98605AX	867	99825-02	867
93600074	826	94127-93T	574	94646-98	835	94863-10	853	98605BF	867	99828-09	856
93600075	824	94130-93T	571	94647-98	836	94865-09	831	98606BF	867	99829-09	855
93600076	825	94131-93T	571	94649-98	842	94868-10	845	98606BY	867	99846-10	827
93600077	824	94132-93T	571	94650-98	843	94869-10	845	98606EK	867	99847-09	855
93600078	825	94133-01	603	94651-09	831	94871-10	846	98625	827	99850-92T	491, 871
93600079	827	94135-93T	737	94656-98	829	94872-10	845	98628EK	867	99855-89	863
93600080	827	94139-01	603	94662-98	835	94873-10	844	98725-91	835	99856-92	863
93600081	826	94140-02	602	94663-02	829	94900-03	791	98864-97	261, 779	99857-97A	863
93600082	825	94148-10	857	94668-00	858	94901-03	791	98959-08	283	99878-87T	864
93600083	826	94204-03A	43, 781	94669-00	859	94902-03	791	98960-97	866	99882-88T	491, 871
93600084	824	94206-03	43, 781	94672-99	842	94923-09	307, 570	98965-99	840	99885-10	862
93600085	826	94207-04	571	94674-99	866	94924-09	570	99000-77	817		
93600107	829	94208-04	571	94675-99	840	94943-07	307, 570	99002-97A	441		
93600108	824	94263-04	41	94684-00A	858	94944-07	122, 570	99020-86T	689		
93600109	824	94280-04	572	94686-00	853	94946-07	122, 570	99020-90T	689		
93600110	829	94281-04	572	94688-00	835	94947-07	570	99027-87T	818		
93600113	864	94289-94T	238	94691-08	305	94948-07	307, 570	99027-90T	818		
93936	867	94291-04A	572	94692-08	305	94949-07	570	99028-87T	818		
94001-03	44	94413-04	641	94693-08	305	94968-09	864	99028-90T	818		
94002-03	44	94415-05	193, 287	94694-08	305	95615-04	771	99352-82Z	818		
94014-03	44	94416-05	305	94695-08	859	95741-01	689	99537-96	689		
94046-03	44, 571	94435-10	859	94697-08	859	95982-98B	836	99539-97	689		
94052-03A	572	94448-82B	269, 859	94699-10	842	95983-07	352, 836	99642-97	865		
94052-07	572	94451-05	641	94704-10	842	96396-09	463	99650-02	864		
94053-03A	572	94452-05	641	94705-10	843	97005-02	490, 549	99653-85	866		
94054-03	572	94453-05	641	94706-10	842	97008-07	789	99661-92T	191, 304, 449		
94055-03	572	94454-05	641	94708-98	116, 199, 301, 771	97026-09	372	99663-92T	191, 304, 449		
94056-03	572	94527-95	571	94753-99	470	97031-09	237	99666-04	689		
94058-03	572					97400-10	824	99667-04	689		

# 902 INDEX

Product	VRSC™	SPORTSTER®	DYNA®	SOFTAIL®	TOURING
Advanced Audio Radio/Accessories	–	–	–	–	654
Air Cleaner Covers	–	548-550	548-550	548-550	548-550
Air Cleaner Covers – Billet	–	549	549	549	549
Air Cleaner Kits	487	480, 482, 487	480-486, 488	480-486, 488	479-486, 480
Air Deflectors	–	–	146	224	338, 343, 346
Air Filter Elements	487, 870	491, 870, 871	491, 870, 871	491, 870, 871	491, 870, 871
Air Filter – K&N®	–	491, 871	491, 871	491, 871	491, 871
Air Foil Luggage Racks	–	92	162	246	–
Air Pump with Light	851	851	851	851	851
Air Wing Caliper and Rotor Cover	–	–	–	–	447
Air Wing Fender Rail for Trike	–	–	–	–	411
Air Wing Horn Cover	–	733	733	733	733
Air Wing Luggage Racks	–	–	–	246	380, 382, 396
Air Wing Saddlebag Lid Rails	–	–	–	–	410
Ancra® Soft Hook Extensions	843	843	843	843	843
Ancra Tie-Downs	843	843	843	843	843
Antennas	–	–	–	–	664-665
Antifreeze and Coolant	863	–	–	–	863
Anti-Seize Products	865-866	865-866	865-866	865-866	865-866
Ape Handlebars	–	628	629-631	630-631	630-631, 634-635
Automatic Compression Releases	–	–	521	521	521
Auxiliary Brake and Tail Lamp	–	713	713	713	398, 402, 713, 717
Auxiliary Lamp Bulbs	–	697, 705	694, 696-697, 705	694, 696-697, 705	694, 696-697, 705
Auxiliary Lamp Covers	–	705	705	705	705
Auxiliary Lighting/Fog Lamps	–	700, 705	694, 696-697, 700-701, 704-705	694, 696-697, 700-702, 704-706	646, 696-697, 700-705
Auxiliary Power Ports	–	100, 672	169, 672	261, 672	424, 672
Auxiliary Switch Housings	613	613	613	613	613
Axle Adjuster Hardware	–	–	–	299	–
Axle Covers – Front	46-47	111	187-189	288	446-447
Axle Covers – Rear	48	115	196	298-299	–
Axle Wrench	–	–	859	859	859
Backpack – Sissy Bar	778	778	778	261, 778, 779	778



Product	VRSC™	SPORTSTER®	DYNA®	SOFTAIL®	TOURING
Backrest – Adjustable	–	86	156	239	377
Backrest Pads – Tour-Pak®	–	98	–	–	393-395
Backrest Pads	40	88, 90-91, 778	150, 160-161, 778	242-245	362, 367, 368-369, 378-379
Badlander® Seats	–	82	151	228	356
Banjo Bolt Kits	615	615	191, 615	304, 615	449, 615
Bare Metal Polish	826	826	826	826	826
Batteries	868	868	868	868	868
Battery Chargers	854-855	854-855	854-855	854-855	854-855
Battery Charging Harness	856	856	856	856	856
Battery Covers/Boxes	–	124	172-173	–	–
Beach Handlebar	–	–	624-625	624-625	624, 632
Bearing Greases	863	863	863	863	863
Belt Guards	48	114	195	295-296	471
Black Fin Engine Trim Collection	–	–	547	547	547
Bobtail Fender Kits	–	–	197, 815	–	–
Bobtail Fender Racks	–	–	164	248	–
Boom!™ Audio Amplifier Kits	–	–	–	–	647-648, 654, 656
Boom! Audio Antennas	–	–	–	–	664-665
Boom! Audio Bass Booster Port Kit	–	–	–	–	658
Boom! Audio Communications	–	–	–	–	646, 660-661
Boom! Audio Fairing Lower Speaker Kits	–	–	–	–	650, 658, 808
Boom! Audio Headsets	–	670	670	670	670-671
Boom! Audio iPod® Interface	–	–	–	–	655
Boom! Audio Music and Intercom Kit	–	–	–	–	646, 660
Boom! Audio Saddlebag Speaker Kit	–	–	–	–	650, 659, 808
Boom! Audio SiriusXM® Satellite Radio	–	–	669	669	646, 655, 669
Boom! Audio Speaker Kits	–	–	662-663	662-663	648-650, 656-659, 662-663
Boom! Audio Speaker Trim	–	–	–	–	461, 462, 465
Boom! Audio Speakers – Saddlebag Mount	–	–	–	–	650, 659, 808
Boom! Bagger Kits	–	–	–	–	648, 656-657
Boom! Audio Amp and Speaker Kits	–	663	662-663	662-663	662-663
Boot Mark Remover	825	825	825	825	825

# 904 INDEX

Product	VRSC™	SPORTSTER®	DYNA®	SOFTAIL®	TOURING
Brake Caliper Covers/Inserts	47	113	190-191	303-305	448-450
Brake Calipers	49	113	190	302-303	448
Brake Disc Hardware	-	771	771	771	450, 771
Brake Fluid	862	862	862	862	862
Brake Levers	54	-	180	271, 272	431-432
Brake Line Clamps	-	619	619	619	-
Brake Lines	-	617	617	617	617
Brake Pads	873	873	873	873	873
Brake Pedal Pads/Covers	-	-	582-596	582-596	582-596
Brake Rotors	50, 770	768-770	768-770	768-770	767-770
Brawler® Solo Seats	-	79, 796-797	149, 796-797	227, 796-797	355, 796-797
Brushed Nickel Collection	587	103, 114, 495, 587	181, 497, 499, 587	274, 587	434, 587
Bug Eater Sponge	829	829	829	829	829
Bug Remover	824	824	824	824	824
Bumpers	-	-	-	292	451, 452, 472
Bungee Cords/Nets/Straps	789	789	789	789	789
Bungee Soft Hooks	789	789	789	789	789
Burst Collection	-	583	536, 583	536, 583	412, 445, 456, 461, 536, 583
Burst Grip/Peg Collection	583	583	583	583	583
Café Fairing	-	77, 803	803	803	-
Cam Tensioner	-	-	518	518	518
Cams	-	-	516-517	516-517	516-517
CD Holder	781	781	781	781	781
Center Stand	-	-	-	283	441
Chain and Lock Kits	844-845	844-845	844-846	844-847	844-848
Chain Lube	863	863	863	863	863
Chizeled Handlebar	-	629	629	-	-
Chopped Fender Edge Light	-	127, 715	715	-	-
Chopped Rear Fender	-	127, 815	-	-	-
Chrome and Rubber Grip/Peg Collection	581, 594-595	581, 594-595	581, 594-595	581, 594-595	581, 594-595
Circulator Seat and Backrest Pads	-	85	154	237	370
Cleaning Brushes	828, 829	828, 829	828, 829	828, 829	828, 829



Product	VRSC™	SPORTSTER®	DYNA®	SOFTAIL®	TOURING
Cleaning/Detailing Products	824-831	824-831	824-831	824-831	824-831
Clocks	681, 683	681, 683	681, 683	681, 683	681, 683
Clutch – Slipper/Variable Pressure	525	–	524	524	524
Clutch Cable Clamps	–	618	618	618	618
Clutch Kits	525	525	524-525	524-525	524-525
Coil Covers	–	126	172	306	–
Color Shop Limited Series	–	798-801	798-801	798-801	798-801
Console Kits	–	109	170-171	266	467
Cover – Sidecar	–	–	–	–	781
Crested Grip/Peg Collection	581, 590	581, 590	581, 590	581, 590	581, 590
Cruise Control Kits	–	–	–	–	563
Cruiser Amp and Speaker Kits	–	663	662-663	662-663	662-663
Cruiser Cradle Wheel Chock	840	840	840	840	840
Cup Holders	–	–	787	263, 787	787
Custom Seat Program	–	796-797	796-797	796-797	796-797
Cylinder Base Cover	–	119	557	557	557
Dark Custom™ Engine Trim Collection	–	120, 538	538	538	538
Dash Panel Extension	–	–	171	266	–
Decals	818	818	818	818	816, 818
Denim Paint Cleaner	825	825	825	825	825
Derby Covers	–	120-122, 536-547	536-547, 552-554	536-547, 552-554	536-547, 551-554
Detach Depot Storage Racks	–	838-839	838-839	838-839	838-839
Detachable Latch Kits	–	89, 847	159, 847	249, 847	375, 847
Detachable Latches – Locking	–	89, 847	159, 847	249, 847	375, 847
Detachable Saddlebags	–	95	165	252-254	403, 404
Detachable Seat Hardware	–	85	155	238	372
Detachable Sideplates/Backrest	–	86	156	239	376-377
Detachables Lock	–	89, 847	159, 847	249, 847	375, 847
Detailing/Cleaning Products	824-831	824-831	824-831	824-831	824-831
Diamond Black Grip/Peg Collection	588	588	588	588	588
Diamond Ice Collection – Flat Medallions	540, 818	540, 818	540, 818	540, 818	540, 818
Diamond Ice Collection – Fuel Tank Trim	–	685-688	684-688	684-688	469, 684-688

# 906 INDEX

Product	VRSC™	SPORTSTER®	DYNA®	SOFTAIL®	TOURING
Diamond Ice Collection – Gauge Trim Rings	–	681	681	681	462, 681
Diamond Ice Collection – License Frames	735	735	735	735	735
Diamond Ice Collection – Speaker Trim	–	–	–	–	462
Diamond Ice Engine Trim Collection	–	121, 540	540	540	540
Dipsticks	45	125	566-567, 682	566-567, 682	566-567, 682
Disc Brake Locks	844	844	844	844	844
Docking Hardware – Sissy Bar/Rack	–	88	157	241	374-375
Docking Hardware Covers	–	89, 573	164, 573	249, 573	573
Down-Tube Bags	–	99, 783	169, 783	–	–
Duffel Bags	774-776, 778	774-778, 779	774-778, 779	774-778, 779	774-778, 779
Dunlop® Inner Tubes	882	882	882	882	882
Dunlop Tires	874, 876-882	874, 876-882	874, 876-882	874, 876-882	874, 876-882
Dunlop Rim Bands	882	882	882	882	882
Edge Cut Collection	–	582	180-181, 582	271-274, 582	432-434, 444, 582
Edge Cut Grip/Peg Collection	582	582	582	582	582
EFI Tuners	–	–	510	510	510
Electra Glo™ Light Pods	720	720	720	720	720
Electra Glo Lighted Footboards	–	–	–	–	721
Electra Glo Light Rails	–	–	–	–	409, 718
Electrical Accessory Adapters	673, 731	673, 731	673, 731	673, 731	673, 731
Engine Brightener	826	826	826	826	826
Engine Covers/Chrome Kits	44-45	117-123	536, 552-563, 568-569	536, 552-563, 568-569	536, 551-563, 568-569
Engine Guard Footpeg Mounts	601-603	601-603	601-603	601-603	601-603
Engine Guards	55	106-107	184-185	280-281	440-441
Engine Mounts	–	116	–	–	560
Engines – LongBlock	–	–	531-533	531-533	531-533
Engine Transmission Interface Covers	–	–	558	558	558
Engines – Revolution®	530	–	–	–	–
Engines – Twin Cam	–	–	529	529	529
Enrichener/Choke Knob Cover	–	563	563	563	563
Ethanol Guard	862	862	862	862	862
Exhaust Mounting Brackets	–	–	194	–	507



Product	VRSC™	SPORTSTER®	DYNA®	SOFTAIL®	TOURING
Exhaust Shields	–	495	499	502	509
Extreme Billet Air Cleaners	–	482	482	482	482
Extreme Ventilator Air Cleaners	–	–	484	484	484
Fairing Air Deflectors	–	–	–	–	343
Fairing Bras	–	–	–	–	423
Fairing Edge Lights	–	–	–	–	349, 723
Fairing Lower Accessories	–	–	–	–	352-353
Fairing Lowers	–	–	–	–	349-353
Fairing Mount Mirrors	–	–	–	–	466, 604-605
Fairing Pouches	–	–	–	–	348, 786
Fairing Trim – Illuminated	–	–	–	–	723
Fender Base Plate Kits	41	–	–	–	–
Fender Bibs	–	82	155	237	–
Fender Bra – Trike	–	–	–	–	421
Fender Skirts	–	–	–	294	453
Fender Strut Covers/Hardware	–	–	197	305, 307	474
Fender Tips/Trim	–	–	193	292-294	451-453
Fenders – Front	–	–	–	814	814
Finned Headbolt Bridges	–	123	568	568	568
First Aid Kits	850	850	850	850	850
Fit Shop Matrix	–	101	174	267	426
Flag Kit – POW/MIA	791	791	791	791	791
Flag Kits – American	791	791	791	791	791
Flame Engine Trim Collection – Chrome	–	121, 544	544	544	544
Flame Engine Trim Collection – Gold	–	121, 545	545	545	545
Flame Grip/Peg Collection	581, 891	581, 891	581, 891	581, 891	581, 891
Flashlights	857	857	857	857	857
Fog Lamps	–	705	705	705	704-705
Foot Controls – Extended Reach	–	104	176	270, 272-273	430-431
Foot Controls – Reduced Reach®	54	105	177	–	–
Footboard Covers	–	–	–	279	438-439
Footboard Mounts – Passenger	–	–	182	278	436-437

# 908 INDEX

Product	VRSC™	SPORTSTER®	DYNA®	SOFTAIL®	TOURING
Footboard Mounts – Rider	–	–	178	276	430
Footpeg Mounts/Hardware	54-55, 603	103, 108, 603	179, 182, 603	270, 277, 603	437, 603
Footpegs and Shifter Pegs	582-597	582-597	582-597	582-597	582-597
Fork Bags	–	–	783	263, 782-783	–
Fork Braces	47	112	189	287	–
Fork Dust Covers	–	–	187	286	–
Fork Nut Covers	–	111	188, 189, 192	289	–
Fork Oil	862	862	862	862	862
Fork Slider Covers/Tins	–	–	–	286	442-445
Fork Sliders	46	110	186	285-286	442-443
Forward Control Kits	–	104-105	176-177	270	–
Front End Kits	–	110	186	285	443
Front End Kits – Inverted Fork	–	–	–	284	–
Fuel Caps – Flush Mount	–	126, 687	686	686, 687	686
Fuel Caps and Medallions	–	685, 687-689	684-689	684-689	684-689
Fuel Gauges	–	109	684, 686	684, 686	680, 684, 686
Fuel Petcock Covers	–	563	563	563	563
Fuel Stabilizer	862	862	862	862	862
Fuel Tank – Sportster®	–	815	–	–	–
Fuel Tank Console Doors	–	–	–	–	467-468
Funnels	853	853	853	853	853
Further Forward Mid-Control Kits	–	105	178	–	–
Garage Door Opener	837	837	837	837	837
Gauge Bezels/Trim Rings	–	681	681	681	460-464, 470, 681
Gauges	–	109, 675, 677-678	675-678	675-678	675-678
Gauges – Fairing Mount	–	–	–	–	680
Gear Indicator	678	678	678	678	678
Get-A-Grip™ Hand Grips	579	579	579	579	579
Glaze Poly Sealant	827	827	827	827	827
Gloss Detailer	826	826	826	826	826
GPS – zūmo®	666-668	666-668	666-668	666-668	666-668
GPS Mounts	668	668	668	668	668



Product	VRSC™	SPORTSTER®	DYNA®	SOFTAIL®	TOURING
Hand Control Lever Kits	52, 614	614-615	614-615	614-615	614-615
Hand Grips	578-596	578-596	578-596	578-596	578-596
Handlebar Amp and Speaker Kits	–	663	662-663	662-663	662-663
Handlebar Clamps	52	641	641	641	641
Handlebar Risers	52	638-640	638-640	638-640	638-640
Handlebars	51	622, 625, 626, 628, 629	623-631	622-631	624, 627, 630-637
Hardware – Chrome	44, 571-575	571-575	571-575	571-575	571-575
Hardware Covers	44	123, 568-571	568-571	307, 568-571	568-571
Harley® Detailing Kit	830	830	830	830	830
Harley Hammock Touring Seats	–	–	–	–	364-365
Harley Travel Care Kit	831	831	831	831	831
Harley® Wash Bucket	828	828	828	828	828
Harley Bike Wash Kit	830	830	830	830	830
H-D Motor Co. Engine Trim Collection	–	121, 541	541	541	541
Head Gasket Kits	–	–	520	520	520
Headbolt Covers/Bridges	–	123, 569	568, 569	568, 569	568, 569
Headlamps – Dual Bulb Halogen	–	–	697	697	697
Headlamp Bulbs	695, 697, 705	695, 697, 705	694-697, 705	694-697, 705	694-697, 705
Headlamp Housings	56	698, 726	698, 726	698, 726	–
Headlamp Modulators	699	699	699	699	699
Headlamp Nacelles	–	–	–	290	456
Headlamp Trim Rings	56	722, 724-726	722, 724-727	722, 724-727	456, 722, 724-727
Headlamp Visors	56	725, 728-729	725, 727-729	725, 727-729	456, 725, 727-729
Headlamps – LED	695	695	694-696	694-696	694-696
Headsets	670-671	670-671	670-671	670-671	670-671
Heated Hand Grips	580-581	580-581	580-581	580-581	580-581
Heated Seats/Backrests	–	–	–	–	363, 364, 394
Heavy Breather Air Cleaners	–	479-481	479-481	479-481	479-481
Helmet Headsets	670-671	670-671	670-671	670-671	670-671
Helmet Locks	846	846	846	846	846
Heritage Saddlebag Quick Detach Kit	–	–	–	255	–
High Capacity Oil Pan	–	–	–	–	521

# 910 INDEX

Product	VRSC™	SPORTSTER®	DYNA®	SOFTAIL®	TOURING
High-Output Alternator Kits	–	–	–	–	425, 673
Highway Peg Mounting Kits	601-603	601-603	601-603	601-603	601-603
Hog Ties® Straps	842-843	842-843	842-843	842-843	842-843
HOG® Blaster Motorcycle Dryer	831	831	831	831	831
Hollywood Handlebar	–	625	625	625	–
Horn Covers	–	733	733	733	733
Horn Kits	732	126, 732	732	732	732
Inner Fairing – Color-Matched	–	–	–	–	458-459, 804-805
Inner Fairing Trim Kits	–	–	–	–	460-464
Inner Primary Cover – Chrome	–	–	556	556	556
iPod® Mounts/Accessories	669, 781	669, 781	669, 781	669, 781	669, 781
Jiffy Stands and Extensions	55	103	179	283	431
K&N® Air Filters and Care Products	–	491, 871	491, 871	491, 871	491, 871
Keyed-To-Match Keys	847	847	847	847	847
Leather Rejuvenator	826	826	826	826	826
LED Headlamps	695	695	694-696	694-696	694-696
LED King Tour-Pak® Brake/Turn/Tail Lamp Kit	–	–	–	–	398, 717
LED Tail Lamps	57	714, 715	714, 715	714, 715	398, 414, 714, 716-717, 719
LED Turn Signals	–	–	707	706, 707	706, 707
License Plates – Side Mount	–	127	197	–	–
License Plate Frames	57, 735-736	127, 734-737	197, 734-737	734-737	734-737
License Plate Hardware	737	736-737	736-737	736-737	736-737
License Plate Mounts – Layback	–	734-735	734-735	734-735	734-735
Lifter Covers	–	119	559	559	559
Lighted Hand Controls	–	–	–	–	612
Live To Ride Engine Trim Collection – Chrome	–	542	542	542	542
Live To Ride Engine Trim Collection – Gold	–	122, 543	543	543	543
Live To Ride Medallions	818	818	818	818	818
Locks and Cables	844-847	844-847	844-847	844-847	844-847
Loctite® Products	864-866	864-866	864-866	864-866	864-866
LongBlock Program	–	–	531-533	531-533	531-533
Lubes and Cleaners	860-867	860-867	860-867	860-867	860-867



Product	VRSC™	SPORTSTER®	DYNA®	SOFTAIL®	TOURING
Luggage – Trike	–	–	–	–	418, 420
Luggage Rack	41	92-93	162-164	246-249	380-383, 396
Magnetic Tank Tote	669, 781	669, 781	669, 781	263, 669, 781	669, 781
Master Cylinder Covers – Rear	–	115	181, 616	271, 616	435, 616
Master Cylinder Cover Kits	53, 610, 613	610-611, 613, 616	610-611, 613, 616	610-611, 613, 616	610-611, 613, 616
Master Cylinder Reservoir Kits	53, 610	610-611, 613, 616	610-611, 613, 616	610-611, 613, 616	610-611, 613, 616
Medallions	817-818	817-818	817-818	817-818	817-818
Metal Flake Seat	–	81	–	–	–
Michelin® Inner Tubes	882	882	882	882	882
Michelin Rim Bands	882	882	882	882	882
Michelin Tires	875, 876-882	875, 876-882	875, 876-882	875, 876-882	875, 876-882
Microfiber Detailing Cloth	829	829	829	829	829
Microphone – CB	–	–	–	–	671
Mid-Control Kits	55	–	–	–	–
Mid-Frame Air Deflectors/Trim	–	–	146	224	349
Mini Footboard Kits	600	600	183, 600	277, 282, 600	600
Mini Tach/Mounts	–	677	677	677	677
Mirrors	604-609	604-609	604-609	604-609	604-609
Modulator – Headlamp	699	699	699	699	699
Motorcycle Covers	832-836	832-836	832-836	832-836	832-836
Motorcycle Oil	860-862	860-862	860-862	860-862	860-862
Mud Flaps	–	–	193	307	473
Muffler End Caps	48	493	–	–	506, 508
Muffler/Exhaust Mount Cover Kits	–	–	194	–	507
Mufflers	–	493-495	496-499	500-502	503-509
Music Player Tank Pouch	669, 781	669, 781	669, 781	669, 781	669, 781
Mustache Engine Guards	–	107	185	281	440
Narrow Band Grip/Peg Collection	589	589	589	589	589
Navigation Interface Module	–	–	–	–	668
Nostalgic Grip/Peg Collection	579, 581, 593	579, 581, 593	579, 581, 593	579, 581, 593	579, 581, 593
#1 Skull Engine Trim Collection	–	120, 539	539	539	539
Oil Cooler Covers	–	125	564	564	565

# 912 INDEX

Product	VRSC™	SPORTSTER®	DYNA®	SOFTAIL®	TOURING
Oil Cooler Kits	–	125	564	564	565
Oil Dipsticks with Temperature Gauge	45	125	566, 682	566, 682	566, 682
Oil Drain Pan	852	852	852	852	852
Oil Filter Wrenches	853	853	853	853	853
Oil Filters	872	872	872	872	872
Oil Funnels	853	853	853	853	853
Oil Pan – High Capacity	–	–	–	–	521
Oil Pressure Gauges	–	–	679	679	678, 679, 680
Oil Pump	–	–	518	518	518
Oil Tank Covers	–	124	–	–	–
Oil Temperature Gauge	45	125	566, 682	566, 682	566, 680-682
Organizer – Tour-Pak®	–	417	–	417	417, 418
Pagers – Security	850	850	850	850	850
Paint Guard Kits	–	–	–	–	422, 423
Paints	867	867	867	867	867
Passenger Arm Rests	–	–	–	–	371
Passenger Backrest Pads	40	88, 90-91	160-161	242-245	367, 370, 378-379, 394-395
Passenger Footboards – Adjustable	–	–	–	–	436-437
Passenger Footboard Covers	–	–	–	279	438-439
Passenger Footboard Supports	–	–	182	278	436-437
Passenger Footboards/Pans	–	–	183, 599-600	278-279, 599-600	435-439, 599-600
Passenger Footpeg Mounts	603	108, 603	182, 603	277, 603	437, 603
Passenger Grab Rails	–	–	–	237	372
Passenger Pillions	40	82	150	227, 234, 236	362
Personal Accents Console Inserts	–	–	–	819	467, 819
Polished Brake Rotors	50, 770	770	770	770	770
Power Port – 12V	–	100, 672	169, 672	261, 672	424, 672
Primary Chain Tension Adjuster	–	–	526	526	526
Primary Cover Trim – Chrome	–	118	556	556	556
Profile® Low Suspension	–	102	175	268-289	427, 429
Pushrod Covers	–	–	559	559	559
Pushrods	–	–	519	519	519



Product	VRSC™	SPORTSTER®	DYNA®	SOFTAIL®	TOURING
Quarter Fairing	-	77, 803	803	-	-
Quick Wash	824	824	824	824	824
Radio and Gauge Trim	-	-	-	-	460-464
Rain Covers – Seats	-	836	155, 836	238, 836	370, 836
Rallyrunner® Seats	-	84	152	228	357
Razor-Pak Luggage	-	-	-	-	391
Reduced Effort Clutch Kit	-	-	616	616	616
Reduced Reach Handlebars	51-52	622	623	622, 623	632, 637
Reduced Reach® Seats	39	83	152	230-231	358-359
Remanufacturing – Engines	-	-	531-533	531-533	531-533
Rider Backrests	-	81, 778	153, 778	235, 778	368-369, 778
Rider Footboards/Inserts	-	-	582-594, 596-599	276, 582-594, 596-599	430, 435, 582-594, 596-599
Rim Seals	882	882	882	882	882
Riser and Clamp Kits	52	639-641	639-641	639-641	639-641
Riser Bushings/Hardware	-	640	640	640	640
Road Zeppelin® Seats	-	84	154	229	357, 366-367
Road Zeppelin Seat Pads	-	85	154	229	367
Saddlebag – Heritage Flat Top Kit	-	-	-	255	-
Saddlebag Bottoms – Stretched	-	-	-	-	404, 810
Saddlebag Coolers	-	-	-	-	420
Saddlebag Filler Strip Kits	-	-	-	-	405, 809
Saddlebag Guard Bags	-	-	-	-	415
Saddlebag Guard Kits	-	-	185	260	406-409
Saddlebag Guard Rail Inserts	-	-	-	-	409
Saddlebag Latches	-	-	-	-	412, 413
Saddlebag Lid Bra	-	-	-	-	421
Saddlebag Lid Rails	-	-	-	-	410-411
Saddlebag Liners	42	100	169	260	416, 418-419
Saddlebag Lock Kits	-	100	169	255, 260	-
Saddlebag Storage Stand	-	-	-	-	831
Saddlebag Supports	-	97	169	260	406
Saddlebags	42	95-98, 782	165-169, 782	250-259, 782	403-421

# 914 INDEX

Product	VRSC™	SPORTSTER®	DYNA®	SOFTAIL®	TOURING
Saddlebags – Detachable	–	95	165	252-254	403, 404
Saddlebags – Hard	–	98	168	251	404, 409, 810
Saddlebags – Throw Over	–	97	168	259	–
Saddlebags – Trike	–	–	–	–	403
Scratch & Swirl Repair	826	826	826	826	826
Screamin' Eagle® Performance	–	479-527	479-527	479-527	479-527
Seat Pads	–	85	154	229, 237	367, 370
Seats	39-40	52-59	148-155	226-236	355-367
Security Systems	848-850	848-850	848-850	848-850	848-850
Service Covers	836	836	836	836	836
Service Lifts	840	840	840	840	840
Shift Levers	54	103	180	271, 273	431, 433
Shift Linkages/Covers	54	103	181	274-275	434
Shifter Pegs and Footpegs	582-597	582-597	582-597	582-597	582-597
Shocks	–	101, 102	175	268-269	427-429
Sidekick® Seats	–	79, 796-797	149, 796-797	228, 796-797	355, 796-797
Sideplate Kits – Adjustable Recline	–	86	156	239	377
Signature Series® Seats	–	81	153	235	362
Silencer Brushed Nickel Collection	587	103, 114, 495, 587	181, 497, 499, 587	274, 587	434, 587
Silencer Grip/Peg Collection	587	587	587	587	587
Sissy Bar Bags	–	776-777, 778-779	776-777, 778-779	261, 776-777, 778-779	776-777, 778
Sissy Bar Uprights	40-41	87-88	150, 158, 159	240, 244, 245	376-377
Skull & Chain Engine Trim Collection	–	120, 546	546	546	546
Skull Grip/Peg Collection	581, 592	581, 592	581, 592	581, 592	581, 592
Slipstream Grip/Peg Collection	580, 584	580, 584	580, 584	580, 584	580, 584
Soft Hooks	843	843	843	843	843
Soft Lowers	–	106	146, 184	224, 280	349
Solo Racks	–	94	164	248, 249	382
Spark Plug Wires	–	522	522, 523	522, 523	522, 523
Spark Plugs	522, 869	522, 869	522, 869	522, 869	522, 869
Speaker Trim – Chrome	–	–	–	–	465
Speakers	–	663	662, 663	662, 663	647-650, 656-659, 662, 663



Product	VRSC™	SPORTSTER®	DYNA®	SOFTAIL®	TOURING
Special Tools	–	857-859	857-859	857-859	857-859
Speedometer/Tachometer Gauges	–	109, 675	675-676	675-676	675-676, 680
Split Vision Mirrors	607	607	607	607	604, 607
Spoilers	–	812	812	812-813	402, 811
Spoilers – Saddlebag Lid	–	–	–	–	402, 811
Spoilers – Tour-Pak®	–	–	–	–	402, 811
Spray Cleaner & Polish	824	824	824	824	824
Spring Saddles	–	80	148	226	–
Sprocket Bolt Covers	–	116, 771	771	301, 771	–
Sprocket Covers	–	116, 765	199, 765	301, 765	765
Sprocket Hardware	–	116, 771	199, 771	301, 771	–
Sprockets	–	766, 767	766, 767	766, 767	766, 767
Stage Kits	–	511, 487	488, 512-515	488, 512-515	488, 512-515
Starters	–	–	560	560	560
Stealth Grip/Peg Collection	581, 586	581, 586	581, 586	581, 586	581, 586
Stitched Seats	–	796-797	796-797	796-797	796-797
Storage Covers	832-836	832-836	832-836	832-836	832-836
Storage Tubes	–	787	787	787	–
Streamliner Grip/Peg Collection	580, 596	580, 596	580, 596	580, 596	580, 596
Street Tuner	–	–	510	510	510
Sun Ray® Heated Seats/Backrests	–	–	–	–	363, 394
Sundowner™ Seats	39	84	150, 153	232-234	360-362
Sunwash® Bike Soap	824	824	824	824	824
Suspension Air Pumps	–	–	–	–	429, 856
Suspension Kits	–	101, 102	175	268-269	427-429
Swingarm – Chrome	–	114	195	296	–
Swingarm Bags	–	99, 782	168, 782	259, 782	–
Swingarm Pivot Bolt Covers	48	115	–	297, 300	–
Switch Cap Kits	53, 612	611, 612	611, 612	611, 612	611, 612
Switch Housing Kits	53, 611	611-613	611-613	611-613	611-613
Switch Panel Accent Cover	–	–	–	–	464
SYN3® Synthetic Oil	860-861	860-861	860-861	860-861	860-861

# 916 INDEX

Product	VRSC™	SPORTSTER®	DYNA®	SOFTAIL®	TOURING
Tachometers – Mini	–	677	677	677	677
Tail Lamps – LED	57	714, 715	714, 715	714, 715	398, 414, 714, 716-717, 719
Tail Lamp Visors	57	729	729	729	729
Tail Light – Tri Bar	–	–	715	715	719
Tallboy® Seats	–	–	153	231	359
Tank Bags	–	94, 778	–	–	–
Tank Panels	–	–	170-171	264-266	–
Tank/Air Box Bra	43	100	155	238	371
Tappet Block Trim	–	119	559	559	559
Tappets	–	520	520	520	520
Thermometers	683	683	683	683	683
Tie-Down Brackets	–	–	–	289	457
Tie-Down Straps	842-843	842-843	842-843	842-843	842-843
Timer Covers	–	120-122, 537-547	537-547	537-547	537-547
Tire Pressure Gauges	851	851	851	851	851
Tires	874-883	874-883	874-883	874-883	874-883
Tool Boxes	–	–	–	262	–
Tool Kits	858-859	858-859	858-859	858-859	858-859
Touring Luggage	774-780	774-780	774-780	774-780	419-420, 774-790
Tour-Pak® – Chopped	–	–	–	–	390
Tour-Pak – King	–	–	–	–	388
Tour-Pak – Leather	–	99	–	250	392
Tour-Pak – Sport	–	98	–	251	–
Tour-Pak Accent Rail	–	–	–	–	397
Tour-Pak Brake/Tail Lamp Kit	–	–	–	–	398, 713, 717
Tour-Pak Conversion Kit	–	–	–	–	386
Tour-Pak Hinges/Latches	–	–	–	–	400-401
Tour-Pak Lid Bra	–	–	–	–	421
Tour-Pak Lid Tether	–	–	–	–	401
Tour-Pak Liners	–	419	–	419	416, 419-420
Tour-Pak Luggage Rack	–	–	–	–	396
Tour-Pak Mounting Rack	–	98	–	250	384-385



Product	VRSC™	SPORTSTER®	DYNA®	SOFTAIL®	TOURING
Tour-Pak® Interior Light Kit	-	-	-	-	387
Transmission and Primary Lubricant	862	862	862	862	862
Transmissions – Evolution®	-	-	527	527	527
Transmissions – Twin Cam	-	-	526, 527	526, 527	526, 527
Transmissions and Gear Sets	-	-	526, 527	526, 527	526, 527
Travel-Paks	-	100, 419	169	260	419-420, 788
Tribal Grip/Peg Collection	585	585	585	585	585
Triple Tree Kits	-	-	192	-	-
Trunk Door Organizer	-	-	-	-	418
Trunk Guard	-	-	-	-	472
Turn Signal Kits – LED	-	-	707	706, 707	706, 707
Turn Signal Lens Kit	57, 707	707	707	706, 707	706, 707
Turn Signal Trim Rings	730	730	730	724-725, 730	724-725, 730
Twin Cam Short Block	-	-	532	532	532
Ultra Boom!™ Bagger Kits	-	-	-	-	648, 656
USB Charging Adaptors	672	100, 672	169, 674	261, 674	424, 674
Valve Springs	-	-	520	520	520
Valve Stem Caps	771	771	771	771	771
Valve Stem Extension	851	851	851	851	851
Ventilator Air Cleaner	-	-	484-486	484-486	484-486
Voltage Regulator Covers	43	126	172	306	455
Voltage Regulators	-	-	-	306	455
Wash Mitt	828	828	828	828	828
Water Pump Covers	-	-	-	-	562
Wheel and Spoke Brush	828	828	828	828	828
Wheel and Tire Cleaner	825	825	825	825	825
Wheel Installation Kits	741	741	741	741	741
Wheel Spacers – Front	-	111	189	287	443
Wheel Spacers – Rear	-	-	194	299	-
Wheel Weights	771	771	771	771	771
Wheels	50	742-743, 760-761, 764	755, 757, 759-764	742-743, 755, 757-760, 763	744-756, 760, 761
Wheels – Aggressor	-	-	-	-	745

Product	VRSC™	SPORTSTER®	DYNA®	SOFTAIL®	TOURING
Wheels – Agitator	–	–	–	–	746
Wheels – Airstrike	–	–	–	–	754
Wheels – Anarchy	–	–	–	–	751
Wheels – Blade	–	–	–	–	753
Wheels – Chisel	–	–	–	–	750
Wheels – Enforcer	–	–	–	–	749
Wheels – Fat X	–	764	–	–	–
Wheels – Impeller	–	–	–	–	748
Wheels – Knuckle	–	–	–	–	752
Wheels – Machete	–	742	–	742	–
Wheels – Magnum 5	–	–	763	763	–
Wheels – Nine-Spoke	–	–	755	755	755
Wheels – Reaper	–	–	759	759	699
Wheels – Road Winder™	–	–	–	–	756
Wheels – Roulette	–	–	–	–	747
Wheels – Slicer	–	–	–	–	744
Wheels – Slotted 6-Spoke	–	761	761	761	761
Wheels – Slotted Cut Back	–	–	707	–	–
Wheels – Stinger	–	–	757	757	–
Wheels – Switchblade	–	–	762	–	–
Wheels – ThunderStar™	–	760	760	760	760
Wheels – Trike	–	–	–	–	751, 764
Wheels – Turbine	–	–	–	758	–
Wheels – Typhoon	–	–	763	763	–
Wheels – Vapor	–	–	762	–	–
Whiskers Highway Bar	–	–	–	282	–
White Grip Collection	579	579	579	579	579
Wide Tire Kits	–	–	198	–	–
Willie G Skull Engine Trim Collection	–	121, 537	537	537	537
Willie G Skull Grip/Peg Collection	581, 592	581, 592	581, 592	581, 592	581, 592
Wind Splitter Windshields	–	–	–	216	336, 340, 344
Windshield Bags	–	784-785	784-785	784-785	348, 784-786



Product	VRSC™	SPORTSTER®	DYNA®	SOFTAIL®	TOURING
Windshield Clamps – Locking	847	77, 847	146, 847	220, 847	–
Windshield Storage Bags	836	836	836	836	836
Windshield Trim Kits	–	–	–	224	342, 347
Windshield Water Repellent	825	825	825	825	825
Windshields – Compact	38	75-76	143-145	217, 219-221	–
Windshields – Electra Glide®	–	–	–	–	340-342
Windshields – King Size	–	–	–	216, 217, 221-223	336-338
Windshields – Replacement Screens	–	–	–	224	337, 338, 341, 346
Windshields – Road Glide®	–	–	–	–	344-247
Windshields – Sport	–	74-75	142	218	341
Windshields – Super Sport	38	74-75	142	218	340, 341
Windshields – Touring	38	76	145	216-217	336-346
Windshields – Ventilator	–	76	145	217	336
Windshields – Wind Splitter	–	–	–	216	336, 340, 344
XR1200™ Backrest	–	94	–	–	–
XR1200 Luggage Rack	–	94	–	–	–
XR1200 Seat Covers	–	813	–	–	–
XR1200 Windshield	–	74	–	–	–
Z-Bar Handlebar	–	629	629	–	–
zūmo® GPS	666-667	666-667	666-667	666-667	666-667

# ONE-YEAR OVER-THE-COUNTER PARTS AND ACCESSORIES WARRANTY

Harley-Davidson warrants that street legal Genuine Motor Parts ("Parts") and street legal Genuine Motor Accessories ("Accessories") that are purchased on or after January 1, 2012 through an authorized dealer will be free from factory defects, under normal use and service, for a period of one year starting from the date of retail sale and delivery (not date of installation). Because this limited warranty covers only Parts and Accessories, labor is not covered. This limited parts warranty does not cover defects or damage due to abuse, misuse or improper installation. This parts warranty applies to Parts and Accessories you or an aftermarket shop have installed, but only for defects in manufacturing—not conditions caused by the improper installation.

This Parts and Accessories warranty is separate and distinct from the limited factory warranty that applies to your stock motorcycle. This Parts and Accessories warranty does not extend or modify the factory warranty that applies to your motorcycle. It only covers the street legal Genuine Motor Parts and street legal Genuine Motor Accessories added to your motorcycle.

This Parts and Accessories warranty does not cover defects, damage or premature wear to your motorcycle that are caused by the installation or use of Parts and Accessories, even those installed by an authorized dealership. Examples include, but are not limited to performance-enhancing powertrain components or software, exhaust systems, non-approved tires, lowering kits, handlebars, add-ons connected to the factory electrical system, etc.

The fact that Parts or Accessories are labeled or branded Harley-Davidson, or are sold or installed by an authorized dealership, does not necessarily make them appropriate or warranted for the make and model of your motorcycle. The use of Parts and Accessories not designed and tested for your motorcycle may have negative consequences on the performance of your motorcycle and may create conditions not covered by the limited factory warranty.

The remedy for breach of this limited Parts and Accessories warranty is expressly limited to the repair or replacement of any component that proves to be defective, and does not extend or create liability for consequential damages, costs or expenses, including loss of time, inconvenience, or loss of use of the motorcycle. Any implied warranty, including warranty of merchantability or fitness for a particular purpose, is expressly limited to the duration of this limited one-year Parts and Accessories warranty, or to the shortest duration permitted by the laws in your state.

## EXCLUDED COMPONENTS:

All Genuine Motor Parts & Accessories will qualify for the one-year over-the-counter warranty, with the following exceptions:

- Tires
- Chemicals
- Premium Luggage (two years)
- Audio and Navigation (two years where applicable)
- Non-street legal components (including Screamin' Eagle® Pro)
- Anything with a manufacturer/factory warranty
- Other disposable and consumable items

**To obtain warranty service, return the affected component(s) with proof of purchase, at your expense, within the limited warranty period to an authorized Harley-Davidson® dealer.**



Harley-Davidson Parts and Accessories Division, a facility of Harley-Davidson Motor Company, is registered to International Quality Standard ISO 9001:2008.

The sale or use of these parts or accessories does not grant the purchaser a license or other right under any Harley-Davidson patent.

**IMPORTANT—PLEASE READ:** We have tried to make this catalog comprehensive and factual. All product descriptions (including depictions, specifications, dimensions, measurements, ratings and competitive comparisons) are based on available information at the time of publication. Although such descriptions are believed correct, errors and changes can occur and complete accuracy cannot be guaranteed. Harley-Davidson may make changes at any time to prices and specifications, and may change or discontinue any of the items depicted in this catalog, without notice and without incurring any obligation.

**ATTENTION:** Vehicles in the configurations shown and the accessories described in this catalog may not be available for sale or use in some locations. Please check with your dealer for complete product details and the latest information.

**TRADEMARKS:** Aluminator, Badlander, Bar & Shield logo, Blackline, Boom!, Brawler, Breakout, Cross Bones, Cruise Drive, Custom Coverage, Custom Vehicle Operations, CVO, Dark Custom, Daymaker, Destroyer, Detonator, Deuce, Diamond Back, Diamondback, Dyna, Eagle Iron, Electra Glide, Electra Glo, Evolution, Fat Bob, Fat Boy, Forty-Eight, Freewheeler, Get-A-Grip, Hard Candy Custom, Harley, Harley-Davidson, Harley-Davidson Street, Harley Owners Group, HD, H-D, H-D1, Heritage Softail, Heritage Springer, H.O.G., HOG, Hog Ties, Hugger, Iron883, Low Rider, Night Rod, Night Train, Nightster, Profile, Rallyrunner, Reach, Reflex, Revolution, Revolution X, Road Glide, Road King, Road Tech, Road Winder, Road Zeppelin, Rocker, Screamin' Eagle, Seventy-Two, Sidekick, Signature Series, Softail, Softail Slim, Split Drag, Sport Glide, Sportster, Springer, Street Bob, Street Glide, Street Rod, Street Stalker, Stripper, Sundowner, Sun Ray, Sunwash, Super Glide, SuperLow, SuperLow 1200T, Switchback, SYN3, Tallboy, ThunderStar, Tour Glide, Tour-Pak, Trick, Tri-Glide, T-Sport, Twin Cam 88, Twin Cam 88B, Twin Cam 96, Twin Cam 96B, Twin Cam 103, Twin Cam 103B, Twin Cam 110, Twin Cam 110B, Twin-Cooled, Ultra Classic, V-Rod, V-Rod Muscle, VRSC, Wide Glide, Willie G, XR1200, XR1200X and the Harley-Davidson Genuine Motor Parts and Genuine Motor Accessories Logo are among the trademarks of H-D U.S.A., LLC.

3M, AGM, Allen, Bike Brite, Blue Buster, Bluetooth, Brembo, City Navigator, Cordura, Dow Corning, Dunlop, Google, Hylomar, iPod, Kevlar, Lexan, Loctite, Marzocchi, Michelin, NavTraffic, NavWeather, Novus, PJ1, Permatex, QuickStix, QuickTape, QuickTite, Scorcher, Scotchlite, SD, Sirius, SiriusXM, Teflon, Threadlocker, Velcro, Windows, Xenoy, XM, zūmo and all other marks are trademarks of their respective owners.



## ALL THAT AND SO MUCH MORE

The 10,000-plus Genuine Motor Parts & Accessories in the full-line catalog are just the beginning. Visit [h-d.com](http://h-d.com) to learn more about customizing your bike, stay current on new products and fitments, read product reviews, and shop online for your specific bike.

KEEP THE DREAM RUNNING FULL-THROTTLE AT [H-D.COM](http://H-D.COM)



### SHOP FOR YOUR BIKE

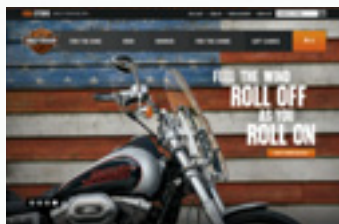

We make it easy to find just what you're looking for. Shop by category, by collection, "Best Selling," and more – sorted by your specific year and model to make sure everything will fit your bike. **Visit [h-d.com/shop](http://h-d.com/shop)**

### CUSTOMIZE YOUR BIKE

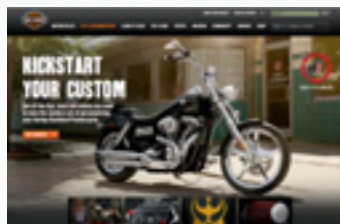

Get inspired. Learn how to dress your bike for fit, function and style. And explore the endless possibilities by viewing photos and parts lists for dozens of fully accessorized motorcycles. **Visit [h-d.com/HD1](http://h-d.com/HD1)**

### BUILD YOUR DREAM BIKE



Bike Builder lets you design your custom bike from the comfort of home, 24/7. Add and remove accessories at the touch of a button – so you can try different looks for your bike, before you buy. **Visit [h-d.com/bikebuilder](http://h-d.com/bikebuilder)**

### VIEW & DOWNLOAD THE LATEST CATALOGS



We are always updating information and adding new products throughout the year. Browse and download a complete electronic PDF version of the 920-page full-line catalog. **Visit [h-d.com/catalog](http://h-d.com/catalog)**



The only way to get Genuine Motor Parts and Accessories is through an authorized Harley-Davidson® dealer or directly from [h-d.com/store](http://h-d.com/store). You can ship your online orders to your local participating Harley-Davidson® dealership where you can pick them up—for free. For your nearest local dealership, please visit our dealer locator at [h-d.com](http://h-d.com) for locations in the U.S.A. and Canada.

We care about you. When riding your Harley-Davidson® motorcycle be sure to ride safely, respectfully and within the limits of the law and your abilities. Always wear an approved helmet, proper eyewear and protective clothing and insist your passenger does too. Never ride while under the influence of alcohol or drugs. Know your Harley® motorcycle and read and understand your owner's manual from cover to cover. Sign up for a Harley-Davidson Rider's Edge® Course (visit [h-d.com/ridersedge](http://h-d.com/ridersedge) for a course near you) or a Motorcycle Safety Foundation rider course (call 1-800-446-9227 for a course near you). Protect your privilege to ride by joining the American Motorcyclist Association. Visit [ama-cycle.org](http://ama-cycle.org) for more information.

The sale or use of these parts or accessories does not grant the purchaser a license or other right under any Harley-Davidson patent.

**IMPORTANT — PLEASE READ:** We have tried to make this catalog comprehensive and factual. All product descriptions (including depictions, specifications, dimensions, measurements, ratings and competitive comparisons) are based on available information at the time of publication. Although such descriptions are believed correct, errors and changes can occur and complete accuracy cannot be guaranteed. Harley-Davidson may make changes at any time to prices and specifications, and may change or discontinue any of the items depicted in this catalog, without notice and without incurring any obligation.

**ATTENTION:** Vehicles in the configurations shown and the accessories described in this catalog may not be available for sale or use in some locations. Please check with your dealer for complete product details and the latest information.